



US00D909388S

(12) **United States Design Patent** (10) **Patent No.:** **US D909,388 S**  
**Akana et al.** (45) **Date of Patent:** **\*\* Feb. 2, 2021**

(54) **HOUSING MODULE FOR AN ELECTRONIC DEVICE**

(71) Applicant: **Apple Inc.**, Cupertino, CA (US)

(72) Inventors: **Jody Akana**, San Francisco, CA (US); **Molly Anderson**, San Francisco, CA (US); **Bartley K. Andre**, Palo Alto, CA (US); **Shota Aoyagi**, San Francisco, CA (US); **Anthony Michael Ashcroft**, San Francisco, CA (US); **Kristina A. Babiarz**, San Jose, CA (US); **Marine C. Bataille**, San Francisco, CA (US); **Jeremy Bataillou**, San Francisco, CA (US); **Carlo Catalano**, Capitola, CA (US); **Markus Diebel**, San Francisco, CA (US); **Ross M. Errett**, San Jose, CA (US); **Lee B. Hamstra**, Mountain View, CA (US); **M. Evans Hankey**, San Francisco, CA (US); **Julian Hoenig**, San Francisco, CA (US); **Richard P. Howarth**, San Francisco, CA (US); **Jonathan P. Ive**, San Francisco, CA (US); **Julian Jaede**, San Francisco, CA (US); **Duncan Robert Kerr**, San Francisco, CA (US); **Melody L. Kuna**, Palo Alto, CA (US); **Carli E. Oster**, San Francisco, CA (US); **Florence Wong Ow**, Burlingame, CA (US); **Peter Russell-Clarke**, San Francisco, CA (US); **Benjamin Andrew Shaffer**, San Jose, CA (US); **Mikael Silvano**, San Francisco, CA (US); **Sung-Ho Tan**, San Francisco, CA (US); **Clement Tissandier**, San Francisco, CA (US); **Eugene Antony Whang**, San Francisco, CA (US); **Devin M. Williams**, Washington, DC (US); **Alex Chun Lap Yeung**, South San Francisco, CA (US); **Rico Zörkendörfer**, San Francisco, CA (US)

(73) Assignee: **Apple Inc.**, Cupertino, CA (US)

(\*\*) Term: **15 Years**

(21) Appl. No.: **29/662,274**

(22) Filed: **Sep. 4, 2018**

(51) **LOC (13) Cl.** ..... **14-02**

(52) **U.S. Cl.**  
USPC ..... **D14/439**

(58) **Field of Classification Search**  
 USPC ..... D14/341-347, 424, 425, 432-453, 464, D14/468, 469, 471, 496, 511, 138 AA, D14/138 AD, 138 C, 138 G, 203.1-203.8, D14/217, 238.1, 248, 250, 257, 299; 361/679.01, 679.02, 679.03, 679.3, 361/679.55, 679.56; 455/550.1, 556.1, 455/556.2, 575.1, 575.3-575.5, 575.8, 455/90.3

CPC .... H04M 1/0277; H04M 1/0202; H04M 1/02; H04B 1/3838

See application file for complete search history.

(56) **References Cited**

U.S. PATENT DOCUMENTS

D30,079 S	1/1899	Sametz
2,968,176 A	1/1961	Collings
D305,717 S	1/1990	Soren et al.
D306,583 S	3/1990	Krolopp et al.
D309,293 S	7/1990	Helbig, Jr. et al.
D332,328 S	1/1993	Lombardi
5,180,644 A	1/1993	Bresin et al.
D333,574 S	3/1993	Ackeret
D340,917 S	11/1993	Sakaguchi et al.
D357,919 S	5/1995	Tsui
5,703,626 A	12/1997	Itoh et al.
D412,157 S	7/1999	Stevenson
6,094,340 A	7/2000	Min et al.
6,276,655 B1	8/2001	Byoun et al.
D451,535 S	12/2001	Lee et al.
D453,930 S	2/2002	Vuolteenaho et al.
D454,868 S	3/2002	Vuolteenaho et al.
D461,802 S	8/2002	Tu
D474,163 S	5/2003	Araki et al.
D490,420 S	5/2004	Solomon et al.
D494,971 S	8/2004	Jobs et al.
D498,235 S	11/2004	Chen et al.
D500,037 S	12/2004	Ozolins et al.

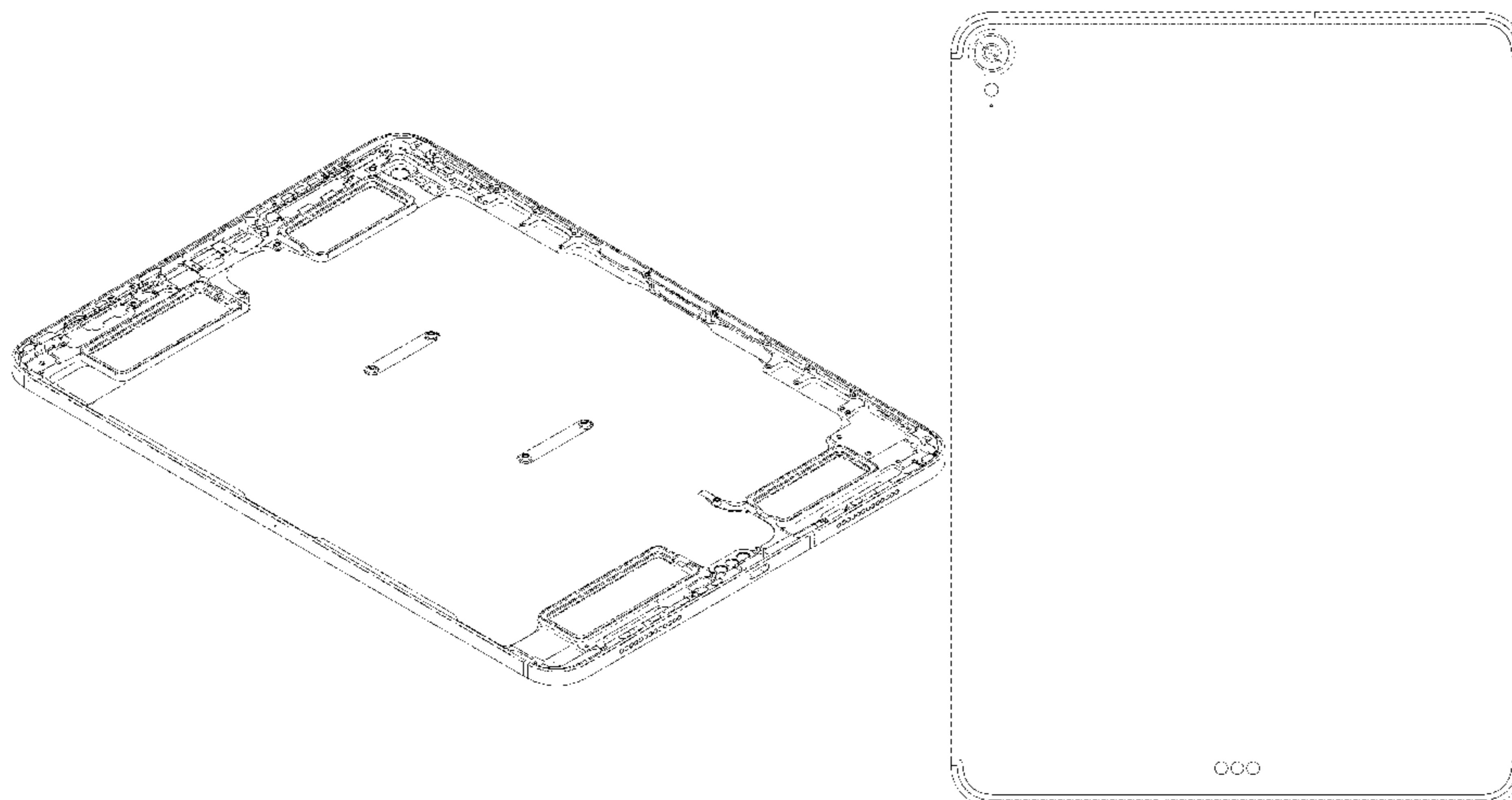

# US D909,388 S

D504,889 S	5/2005	Andre et al.	D641,018 S	7/2011	Lee et al.
D543,979 S	6/2007	Lee	D642,563 S	8/2011	Akana et al.
D548,732 S	8/2007	Cebe et al.	D645,435 S	9/2011	Kim et al.
D558,756 S	1/2008	Andre et al.	D645,833 S	9/2011	Seflic et al.
D558,757 S	1/2008	Andre et al.	D646,266 S	10/2011	Kim et al.
D558,758 S	1/2008	Andre et al.	D648,303 S	11/2011	Park et al.
D569,837 S	5/2008	Baik et al.	D648,305 S	11/2011	Chen
D574,819 S	8/2008	Andre et al.	D648,722 S	11/2011	Meyerhoffer et al.
D580,387 S	11/2008	Andre et al.	D649,968 S	12/2011	Li
D585,056 S	1/2009	Ekelund et al.	D650,381 S	12/2011	Park et al.
D585,411 S	1/2009	Eaton	D651,606 S	1/2012	Luijben
D593,553 S	6/2009	Okamoto et al.	8,106,836 B2	1/2012	Hill et al.
D597,067 S	7/2009	Oh et al.	D654,497 S	2/2012	Lee
D599,342 S	9/2009	Andre et al.	D656,136 S	3/2012	Lee
D599,736 S	9/2009	Ferber et al.	D656,477 S	3/2012	Yi et al.
D599,797 S	9/2009	Kim	D657,782 S	4/2012	Biller
D600,241 S	9/2009	Andre et al.	D659,692 S	5/2012	Jung et al.
D601,105 S	9/2009	Morabito	D662,503 S	6/2012	Akana et al.
D601,559 S	10/2009	Green et al.	D663,298 S	7/2012	Song et al.
D602,014 S	10/2009	Andre et al.	8,243,429 B2	8/2012	Zadesky et al.
D602,015 S	10/2009	Andre et al.	D666,563 S	9/2012	Lee et al.
D602,017 S	10/2009	Andre et al.	D670,692 S	11/2012	Akana et al.
D602,488 S	10/2009	Jiang et al.	D671,947 S *	12/2012	Akana ..... D14/439
D604,289 S	11/2009	Andre et al.	D673,562 S	1/2013	Johnson
D604,292 S	11/2009	Andre et al.	D673,952 S	1/2013	Toda et al.
D604,297 S	11/2009	Andre et al.	D673,958 S *	1/2013	Fathollahi ..... D14/439
D604,733 S	11/2009	Andre et al.	D677,255 S	3/2013	McManigal et al.
D606,988 S	12/2009	Andre et al.	D677,659 S	3/2013	Akana et al.
D608,763 S	1/2010	Andre et al.	D677,665 S *	3/2013	Akana ..... D14/439
D609,226 S	2/2010	Hofer et al.	D678,288 S *	3/2013	Feldstein ..... D14/439
D609,705 S	2/2010	Andre et al.	D680,526 S	4/2013	Gammon et al.
D611,469 S	3/2010	Andre et al.	D681,032 S	4/2013	Akana et al.
7,688,574 B2	3/2010	Zadesky et al.	D681,632 S	5/2013	Akana et al.
D614,161 S	4/2010	Andre et al.	D684,571 S	6/2013	Akana et al.
D614,162 S	4/2010	Andre et al.	D685,752 S	7/2013	Kimura et al.
7,697,281 B2	4/2010	Dabov et al.	D687,404 S	8/2013	Yoshimura
D615,554 S	5/2010	Andre et al.	D688,218 S	8/2013	Lee
D617,751 S	6/2010	Lee et al.	8,526,180 B2	9/2013	Rayner
D617,762 S	6/2010	Hong et al.	8,535,075 B1	9/2013	Golko et al.
D617,792 S	6/2010	Andre et al.	D694,755 S	12/2013	Akana et al.
D618,204 S	6/2010	Andre et al.	D695,704 S	12/2013	Kim et al.
D618,241 S	6/2010	Akana et al.	D695,737 S	12/2013	Kim et al.
D618,242 S	6/2010	Akana et al.	D697,911 S	1/2014	McManigal et al.
D619,361 S	7/2010	Andre et al.	D698,770 S	2/2014	Park
D619,555 S	7/2010	Yang et al.	D701,208 S *	3/2014	Ai ..... D14/439
D620,004 S	7/2010	Andre et al.	D702,219 S	4/2014	Suk
D622,270 S	8/2010	Andre et al.	D705,188 S	5/2014	Chau et al.
D622,514 S	8/2010	Park et al.	D706,235 S	6/2014	Kim
D622,716 S	8/2010	Andre et al.	D706,251 S	6/2014	Park
D622,718 S	8/2010	Andre et al.	D706,301 S	6/2014	Akana et al.
D622,719 S	8/2010	Andre et al.	D707,223 S	6/2014	Akana et al.
D623,184 S	9/2010	Green et al.	D708,186 S *	7/2014	Akana ..... D14/439
D624,536 S	9/2010	Andre et al.	D708,608 S	7/2014	Sugiyama et al.
D625,303 S	10/2010	Kim	D710,855 S *	8/2014	Akana ..... D14/439
D625,307 S	10/2010	Cheng	8,804,353 B2	8/2014	Montevirgen et al.
D626,937 S	11/2010	Yeo et al.	D712,384 S	9/2014	Hibi
D626,957 S	11/2010	Juan et al.	D712,405 S	9/2014	Akana et al.
D627,344 S	11/2010	Chien et al.	D713,833 S	9/2014	Wilkey
D627,777 S	11/2010	Akana et al.	D716,250 S	10/2014	Becker et al.
D627,778 S	11/2010	Akana et al.	D718,767 S *	12/2014	Akana ..... D14/439
D630,207 S	1/2011	Seong	D720,747 S	1/2015	Kim et al.
D630,630 S	1/2011	Andre et al.	D723,495 S	3/2015	Jeong
D631,474 S	1/2011	Green et al.	D731,481 S	6/2015	Akana et al.
7,869,206 B2	1/2011	Dabov et al.	D732,498 S	6/2015	Huang et al.
D632,688 S	2/2011	Seong et al.	D732,538 S *	6/2015	Corbin ..... D14/439
D633,090 S	2/2011	Andre et al.	D734,758 S *	7/2015	Myung ..... D14/439
D633,092 S	2/2011	Andre et al.	D745,004 S	12/2015	Kim
D636,390 S	4/2011	Andre et al.	D749,077 S *	2/2016	Akana ..... D14/439
D636,752 S	4/2011	Liao et al.	D752,036 S	3/2016	Ho et al.
D636,769 S	4/2011	Wood et al.	D759,008 S	6/2016	Akana et al.
D636,770 S	4/2011	Li	D764,431 S	8/2016	Hibi et al.
7,933,123 B2	4/2011	Wang et al.	D767,572 S *	9/2016	Akana ..... D14/439
D637,596 S	5/2011	Akana et al.	D771,620 S	11/2016	Kim et al.
D638,003 S	5/2011	Chen	D774,031 S	12/2016	Otani
D638,815 S	5/2011	Lee et al.	D781,807 S	3/2017	Hubbard et al.
D639,261 S	6/2011	Garnham et al.	D783,602 S	4/2017	Akana et al.
D639,763 S	6/2011	Kim et al.	D790,535 S	6/2017	Akana et al.
D639,771 S	6/2011	Chen	D791,732 S	7/2017	Xu et al.
D640,663 S	6/2011	Arnholt et al.	D792,366 S	7/2017	Zhang et al.

D800,716	S	10/2017	Akana et al.	
D803,209	S	11/2017	Akana et al.	
D814,475	S *	4/2018	Jung .....	D14/439
D816,649	S	5/2018	Song et al.	
D825,570	S *	8/2018	Akana .....	D14/439
D826,235	S *	8/2018	Akana .....	D14/439
D832,850	S *	11/2018	Oh .....	D14/439
D842,298	S	3/2019	Akana et al.	
D866,562	S *	11/2019	Kononov .....	D14/439
D881,194	S *	4/2020	Kononov .....	D14/439
2006/0237599	A1	10/2006	Ternus et al.	
2008/0225468	A1	9/2008	Huang et al.	
2009/0067141	A1	3/2009	Dabov et al.	
2009/0256759	A1	10/2009	Hill et al.	
2010/0061055	A1	3/2010	Dabov et al.	
2010/0142134	A1	6/2010	Zadesky et al.	
2010/0146766	A1	6/2010	Dabov et al.	
2011/0050560	A1	3/2011	Foster et al.	
2011/0088838	A1	4/2011	Thompson et al.	
2011/0164365	A1	7/2011	McClure et al.	
2011/0166690	A1	7/2011	Ternus et al.	
2011/0180557	A1	7/2011	Kenney et al.	
2011/0299231	A1	12/2011	Gaddis, II et al.	
2012/0044123	A1	2/2012	Rothkopf et al.	
2012/0048589	A1	3/2012	Jol et al.	
2012/0051025	A1	3/2012	Jol et al.	
2012/0097412	A1	4/2012	Wennemer et al.	
2012/0194997	A1	8/2012	McClure et al.	
2013/0162569	A1	6/2013	Sudo	
2014/0284096	A1	9/2014	Wu et al.	

FOREIGN PATENT DOCUMENTS

CN	301867415	S	3/2012
CN	302242618	S	12/2012
CN	302268386	S	1/2013
CN	302279529	S	1/2013
CN	302321988	S	2/2013
CN	302333118	S	2/2013
CN	302350915	S	3/2013
CN	302404040	S	4/2013
CN	302430473	S	5/2013
CN	202998218	U	6/2013
CN	302455942	S	6/2013
CN	302476338	S	6/2013
CN	302560014	S	9/2013
CN	302588771	S	9/2013
CN	302606411	S	10/2013
CN	302808732	S	4/2014
CN	302873818	S	7/2014
CN	302982246	S	10/2014
CN	303000183	S	11/2014
CN	303000194	S	11/2014
EM	002088591-0001		8/2012
EP	001767435-0001		10/2010
EP	001802315-0001		1/2011
JP	D1142127		5/2002
JP	D1250487		9/2005
JP	D1326330	S	4/2008
JP	D1351277	S	2/2009
JP	D1456810	S	12/2012
JP	D1469635	S	5/2013
JP	D1478342	S	9/2013
KR	30-0598021		5/2011
TW	D149042	S	9/2012
WO	WO-DM080555	S	2/2013

OTHER PUBLICATIONS

Apple iPhone 7: Dual-Lens Camera Leak Suggests 3D Scanning Capabilities, posted Mar. 16, 2016, [retrieved Aug. 5, 2017]. Retrieved from Internet, (URL: <http://www.newsweek.com/apple-iphone-7-dual-lens-camera-leak-suggests-3d-scanningcapabilities-437322>).

Arrington, M., TechCrunch, “We Want a Dead Simple Web Tablet for \$200. Help Us Build It.” (<http://techcrunch.com/2008/07/21/we-want-a-dead-simple-web-tablet-help-us-build-it/>), published Jul. 21, 2008, 4 pages.

Carlson, Ronald, Tapscape.com, “Translucent iPhone: Will Apple Revisit G3 iMac?,” accessed at <http://www.tapscape.com/translucent-iphone/>, accessed on Apr. 3, 2013, 3 pages.

Cultofandroid, “This Android-Powered iPhone 5C Clone Will Cost Just \$100 in China” accessed at [http://www.cultofandroid.com/40408/this-android-powered-iphone-5c-clone-will-cost-just-100-in-china/?utm\\_campaign=twitter&utm\\_medium=twitter&utm\\_source=twitter](http://www.cultofandroid.com/40408/this-android-powered-iphone-5c-clone-will-cost-just-100-in-china/?utm_campaign=twitter&utm_medium=twitter&utm_source=twitter), accessed on Aug. 27, 2013, 2 pages.

Daily Life News, “iPhone 5s Leaked Images Hint 2 Different Screen Sizes.” accessed at <https://www.youtube.com/watch?v=8tcTHa63WHI>, accessed on Apr. 10, 2013, 4 pages.

Gokey, M., “LG G3 vs. HTC One M8: Which Android Flag Should iPhone Haters Fly?,” published Sep. 18, 2014, accessed at [www.digitaltrends.com/mobile/lg-g3-vs-htc-one-m8/](http://www.digitaltrends.com/mobile/lg-g3-vs-htc-one-m8/), 12 pages.

Gsmarena, “Nokia Lumia 820”, accessed at [http://www.gsmarena.com/nokia\\_lumia\\_820-4968.php](http://www.gsmarena.com/nokia_lumia_820-4968.php), accessed on Aug. 29, 2013, 2 pages.

Gsmarena, “Xiaomi MI-2”, accessed at [http://www.gsmarena.com/xiaomi\\_mi\\_2-4928.php](http://www.gsmarena.com/xiaomi_mi_2-4928.php), accessed on Aug. 29, 2013, 2 pages.

Gsmarena, “Xiaomi MI-2s”, accessed at [http://www.gsmarena.com/xiaomi\\_mi\\_2s-5397.php](http://www.gsmarena.com/xiaomi_mi_2s-5397.php), accessed on Aug. 29, 2013, 2 pages.

iPhone 6 Plus, Gold, 16GB (Unlocked), posted Nov. 2, 2014, [retrieved Aug. 5, 2017]. Retrieved from Internet, URL: [https://www.amazon.com/iPhone-Plus-Gold-16GB-Unlocked/dp/B00OB5TCN6/ref=cm\\_cr\\_ar\\_p\\_d\\_product\\_top?ie=UTF8](https://www.amazon.com/iPhone-Plus-Gold-16GB-Unlocked/dp/B00OB5TCN6/ref=cm_cr_ar_p_d_product_top?ie=UTF8).

“iPhone 6, Une Enieme Maquette Comparee Avec L’iPhone 5s,” published May 3, 2014, accessed at <http://www.nowhereelse.fr/iphone-6-maquette-comparee-iphone-5s-97315/>, 2 pages.

iPhone 7 Realistic 3D Video Rendering Based on Latest Leaks Pops Up (Video), posted Mar. 20, 2016, [retrieved Aug. 5, 2017]. Retrieved from Internet( URL: <https://www.concept-phones.com/apple/iphone-7-realistic-3d-video-rendering-based-latest-leakspops-video>), 3pages.

iPhone X Case, ESR 9H Tempered Glass Back Cover, accessed at [https://www.amazon.com/ESR-Tempered-Scratch-Resistant-Silicone-Absorption/dp/B079HP8T8V/ref=cm\\_cr\\_ar\\_p\\_d\\_product\\_top?ie=UTF8](https://www.amazon.com/ESR-Tempered-Scratch-Resistant-Silicone-Absorption/dp/B079HP8T8V/ref=cm_cr_ar_p_d_product_top?ie=UTF8), accessed on May 9, 2018, 2 pages.

MacManus, Christopher, cnet.com, “Artist pictures a budget iPhone—in color.” accessed at <http://www.cnet.com/au/news/artist-pictures-a-budget-iphone-in-color/>, accessed at Mar. 21, 2013, 4 pages.

Mayo, B., “Purported iPhone 6 Pictures Show Protruding Camera, Rounded Edges,” 9to5Mac.com, accessed at <http://9to5mac.com/2014/03/31/purported-iphone-6-pictures-show-protruding-camera-rounded-edges/>, 23 pages.

My Burmese Blog, “Apple Touch Screen Netbook Prototypes Hit the Web,” (<http://www.htootayzar.com/myblog/2009/03/apple-touch-screen-netbook-prototypes-hit-the-web/>), published Mar. 12, 2009, 10 pages.

Nokia, “Nokia Lumia 820—Our most versatile Lumia”, accessed at <http://www.nokia.com/global/products/phone/lumia820/>, accessed on Aug. 29, 2013, 6 pages.

@NowhereElseFr, “Just Another Purported #iPhone6 or #iPhoneAir Dummy . . . #Apple,” published May 4, 2014, accessed at <https://twitter.com/NowhereElseFr/status/462938116924264448/photo/1>, 5 pages.

Photo—John, “Apple’s iPhone 5 Camera—What’s New?”, as archived at <https://web.archive.org/web/20140805181048/http://www.photographyreview.com/reviews/apple-iphone-5-camera-whats-new>, published Sep. 12, 2012, 3 pages.

First Details on iPhone 7 Design: Flush Rear Camera, No Antenna Bands Across the Back, posted Feb. 2, 2016, [retrieved on Nov. 29, 2017]. Retrieved from Internet, (URL: <https://www.macrumors.com/2016/02/02/iphone-7-flush-camera-no-bands/>).

Gionee S10 is an iPhone 7 Plus look-alike but with 4 cameras, 6GB RAM and half the price, S10B and S10C also unveiled., posted May 30, 2017, [retrieved May 9, 2018]. Retrieved from Internet, (URL: <https://techmoran.com/%E2%80%8Bgionee-s10-is-an-iphone-7-plus-look-alike-but-with-4-cameras-6gb-ram-and-half-the-price-s1>).

iPhone 7 Leak Reveals Significant Design Changes (Video), posted Feb. 3, 2016,[retrieved on Nov. 29, 2017]. Retrieved from Internet, (URL: <https://www.youtube.com/watch?v=9oRsTRfkGIs>).

New iPhone 7—Final Leaks & Rumors (Video), posted Feb. 7, 2016, [retrieved on Nov. 29, 2017]. Retrieved from Internet, (URL: [https://www.youtube.com/watch?v=\\_CuyHrhWGto](https://www.youtube.com/watch?v=_CuyHrhWGto)).

Wileyfox Swift and Storm review: Two cheap UK phones, one worth buying, posted Nov. 30, 2015, [retrieved May 9, 2018]. Retrieved from Internet, (URL: <https://www.engadget.com/2015/11/30/wileyfox-swift-storm-review/> ).

Ricker, “Meizu’s M8? Apple lawyers, start your engines,” Engadget.com, (<http://www.engadget.com/2007/01/29/meizus-m8-apple-lawyers-start-your-engines/>), published Jan. 29, 2007, 1 page.

Apple’s Reply in Support of its Motion for a Preliminary Injunction (Redacted), p. 11 *Apple Inc. v. Samsung Electronics Co., Ltd.*, United States District Court, Northern District of California, San Jose Division, Case. No. 11-cv-01846-LHK, dated Oct. 13, 2011, 38 pages total.

LG’s G5 Shows Bold Mobile Move, We Go Hands-On, posted Feb. 21, 2016, [retrieved May 9, 2018]. Retrieved from Internet, (URL: [https://http://www.tomshardware.com/reviews/lg-g5-android-smartphone-hands-on\\_4474.html#p1](https://http://www.tomshardware.com/reviews/lg-g5-android-smartphone-hands-on_4474.html#p1)).

Stuff Staff in News, stuffimideast.com “Apple’s new iPhone to come in a five colours.” accessed at <http://stuffimideast.com/2013/04/11/151344/apples-new-iphone-to-come-in-a-five-colours/>, accessed on Apr. 11, 2013, 1 page.

stuff.tv, “Spare wallets rejoice, the plastic budget iPhone 5S cometh, The iPhone 5S may not be an incremental increase but a decrease, in price and build quality.” accessed at <http://www.stuff.tv/apple/spare-wallets-rejoice-plastic-budget-iphone-5s-cometh/news>, accessed on Mar. 23, 2013, 1 page.

Swift, “BBK Vivo Xplay X510W Review,” published Oct. 21, 2013, accessed at <http://chinesetech.net/2013/10/21/bbk-vivo-xplay-x510w-review/>, 12 pages.

welectronics.com, “Xiaomi MI 2 GSM unlocked,” accessed at <http://www.welectronics.com/gsm/misc/XIAOMI-MI-2.HTML?gclid=CK7Nr9bv-rYCFY0o4AodZ0EAEW>, accessed at Aug. 29, 2013, 2 pages.

\* cited by examiner

*Primary Examiner* — Austin Murphy  
(74) *Attorney, Agent, or Firm* — Sterne, Kessler, Goldstein & Fox P.L.L.C.

(57)

### CLAIM

The ornamental design for a housing module for an electronic device, as shown and described.

### DESCRIPTION

FIG. 1 is a bottom front perspective view of a housing module for an electronic device showing the claimed design; FIG. 2 is a bottom rear perspective view thereof; FIG. 3 is a front view thereof; FIG. 4 is a rear view thereof; FIG. 5 is a left side view thereof; FIG. 6 is a right side view thereof; FIG. 7 is a top view thereof; FIG. 8 is a bottom view thereof; FIG. 9 is a bottom front perspective view of a housing module for an electronic device showing the claimed design; FIG. 10 is a bottom rear perspective view thereof; FIG. 11 is a front view thereof; FIG. 12 is a rear view thereof; FIG. 13 is a left side view thereof; FIG. 14 is a right side view thereof; FIG. 15 is a top view thereof; and, FIG. 16 is a bottom view thereof.

**1 Claim, 12 Drawing Sheets**

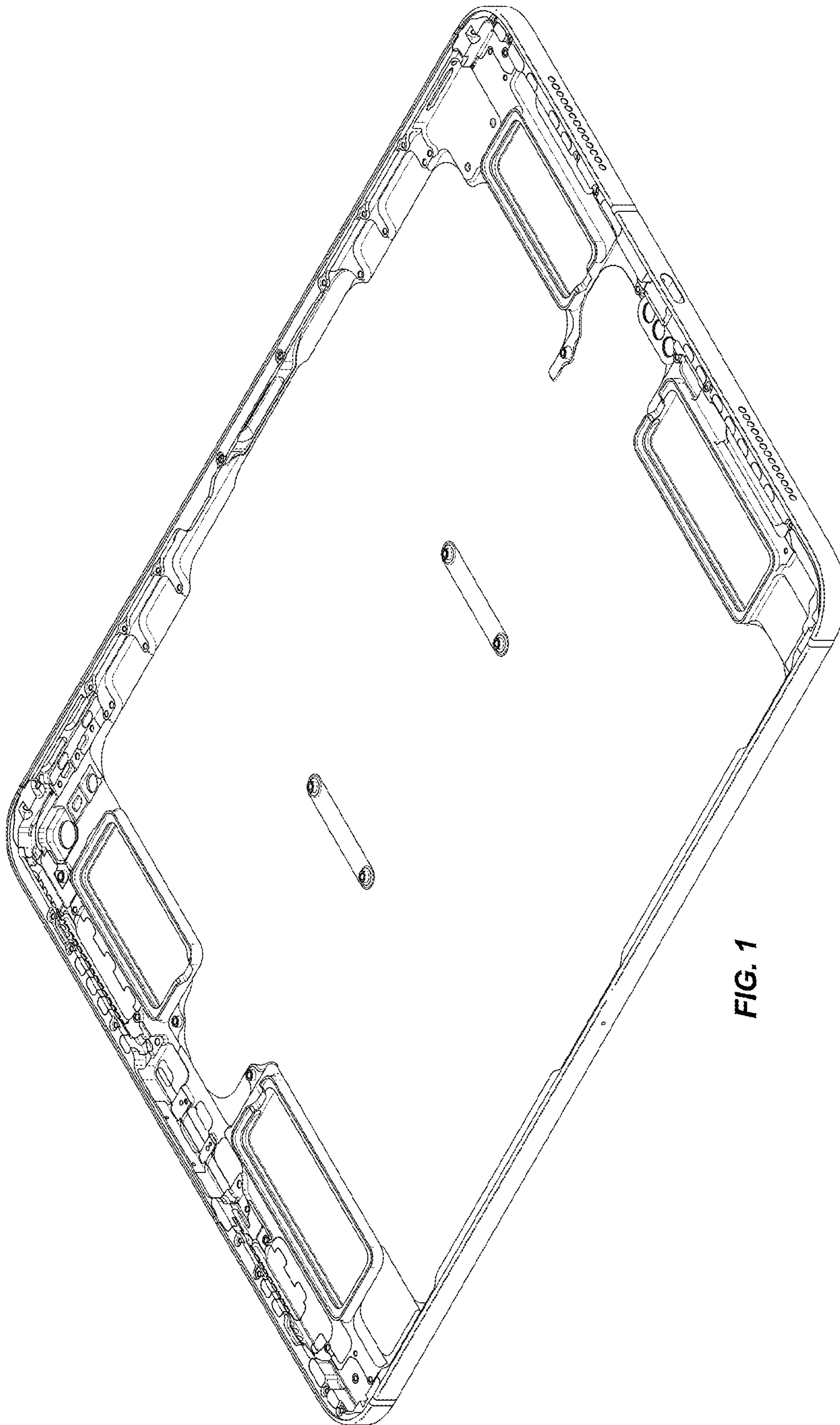

FIG. 1

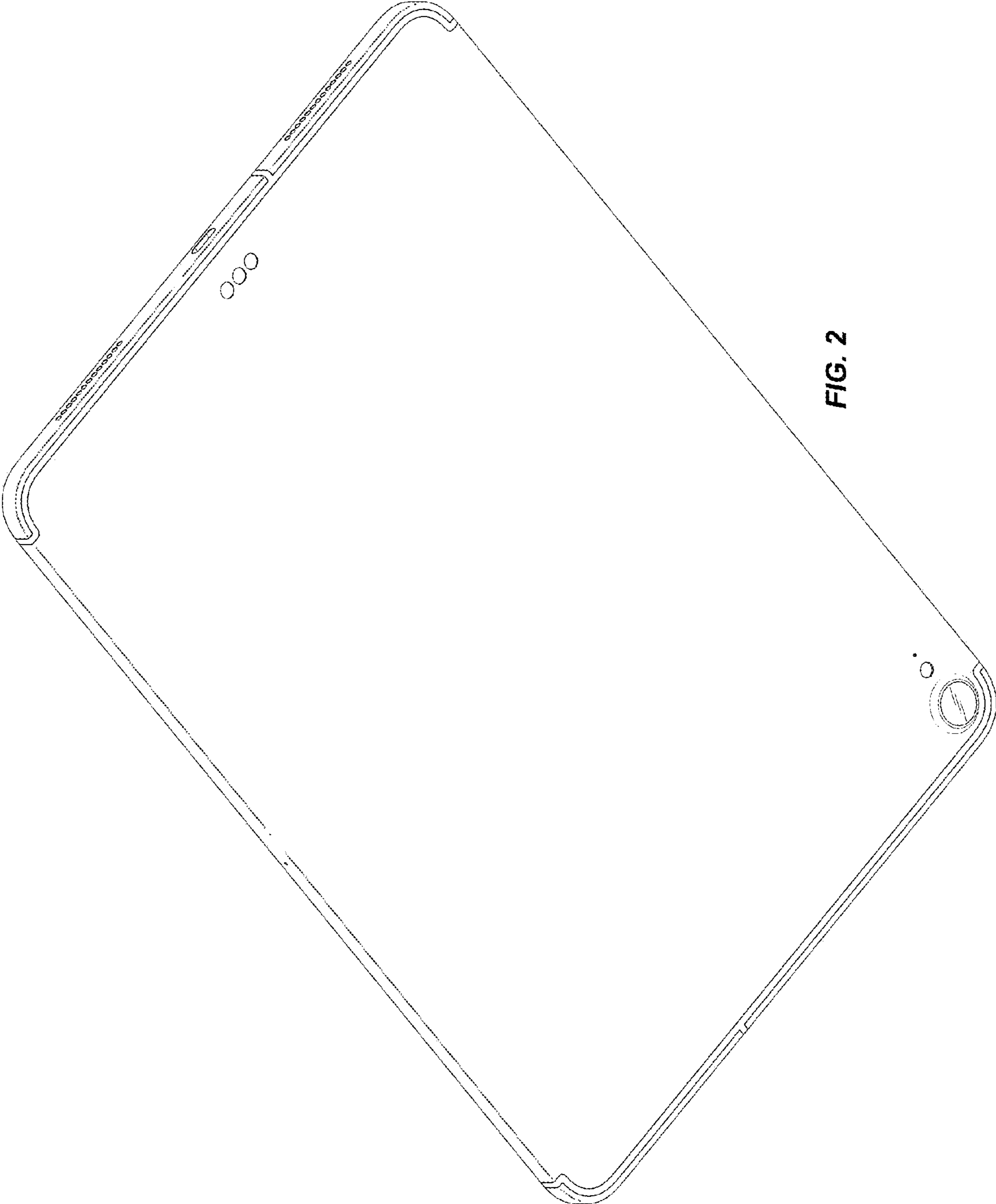

FIG. 2

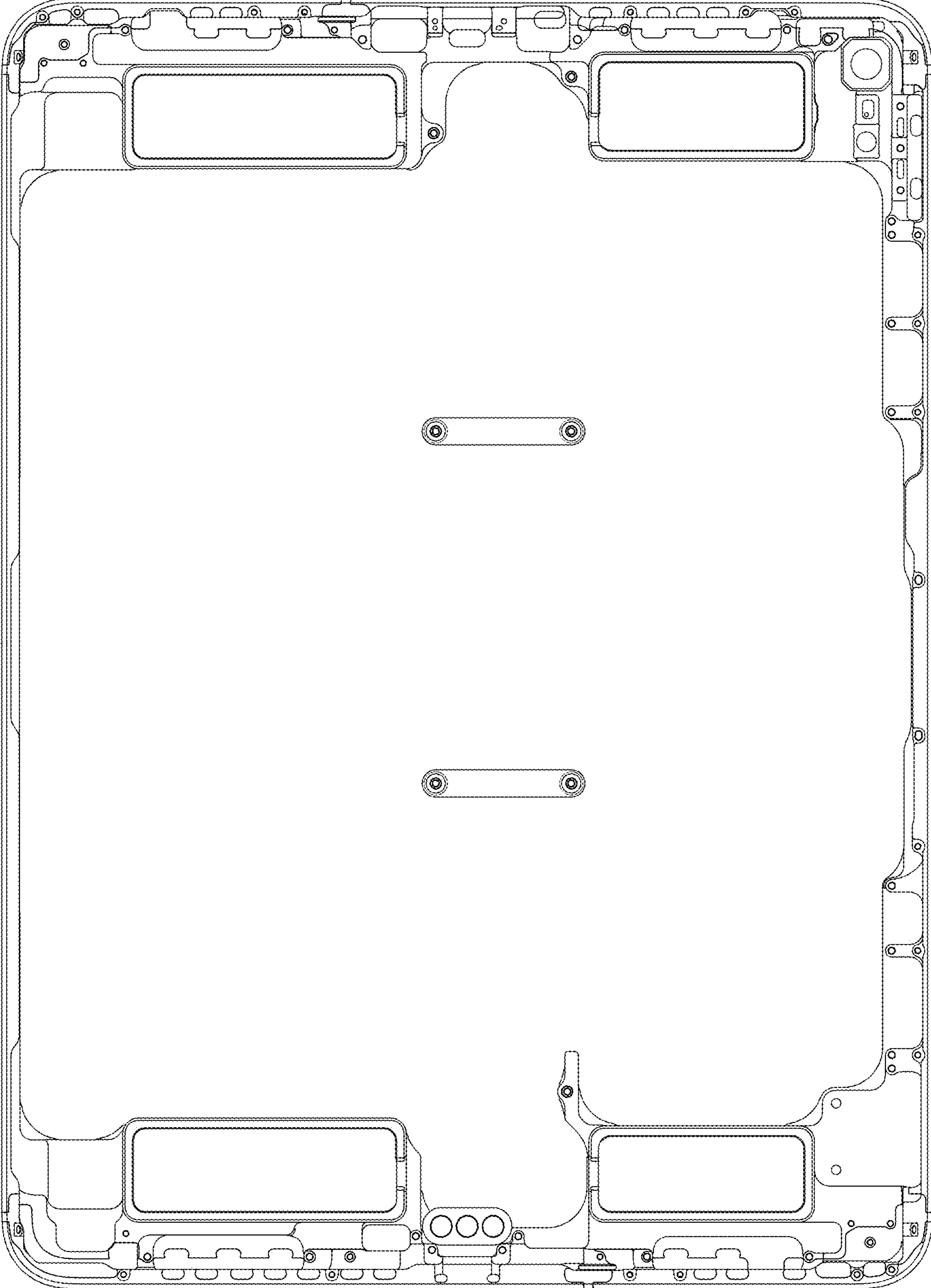

FIG. 3

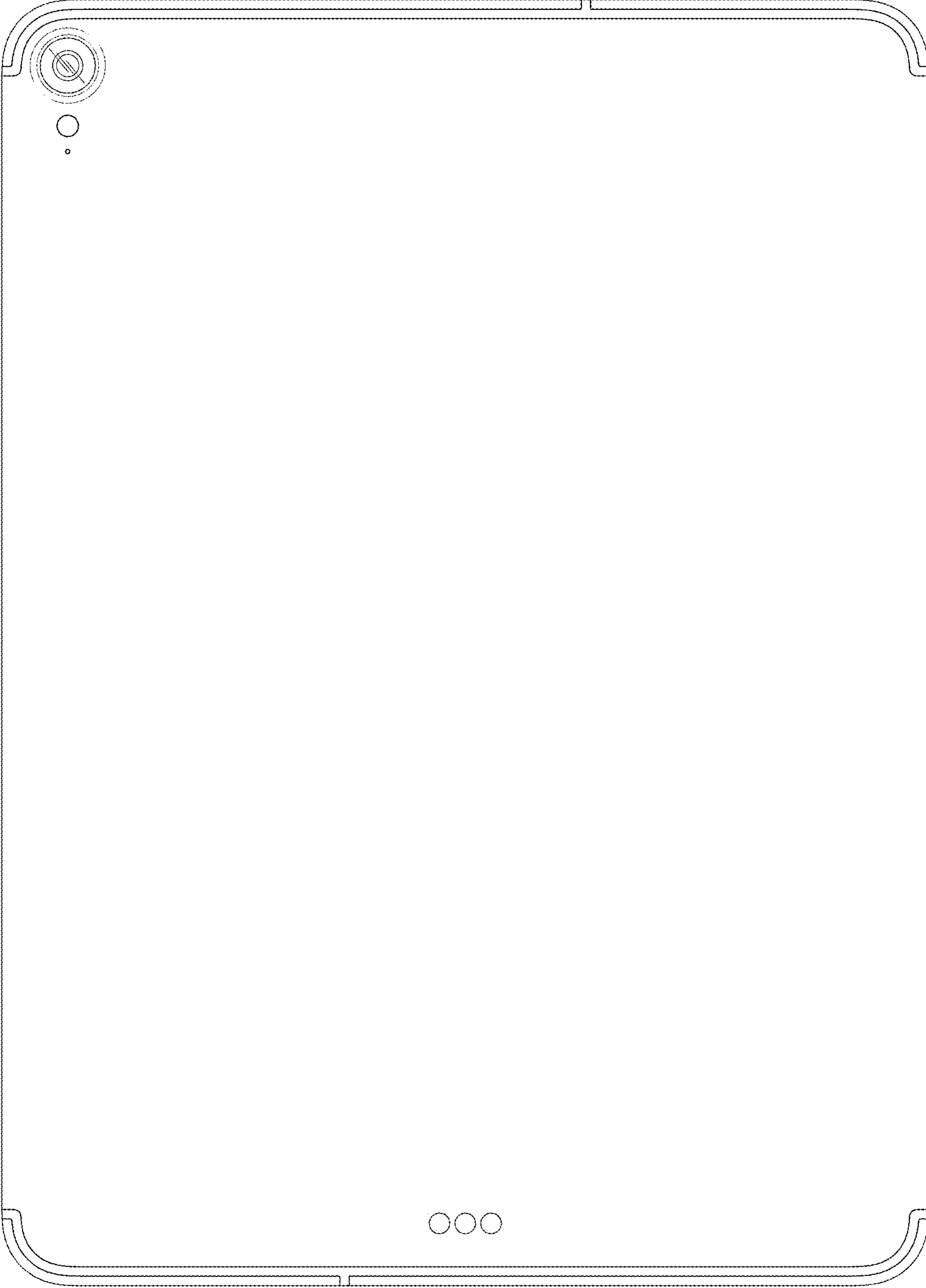
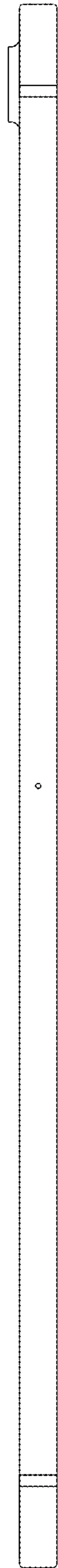
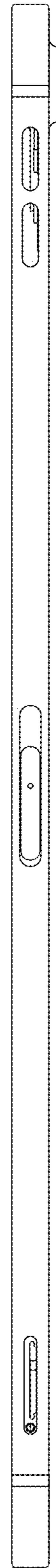

FIG. 4

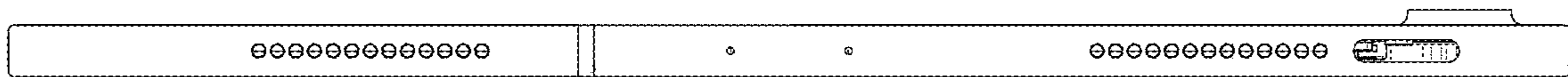



**FIG. 5**



**FIG. 6**



**FIG. 7**

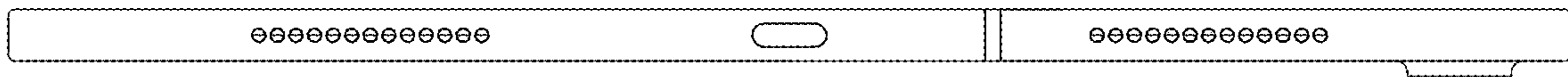

**FIG. 8**

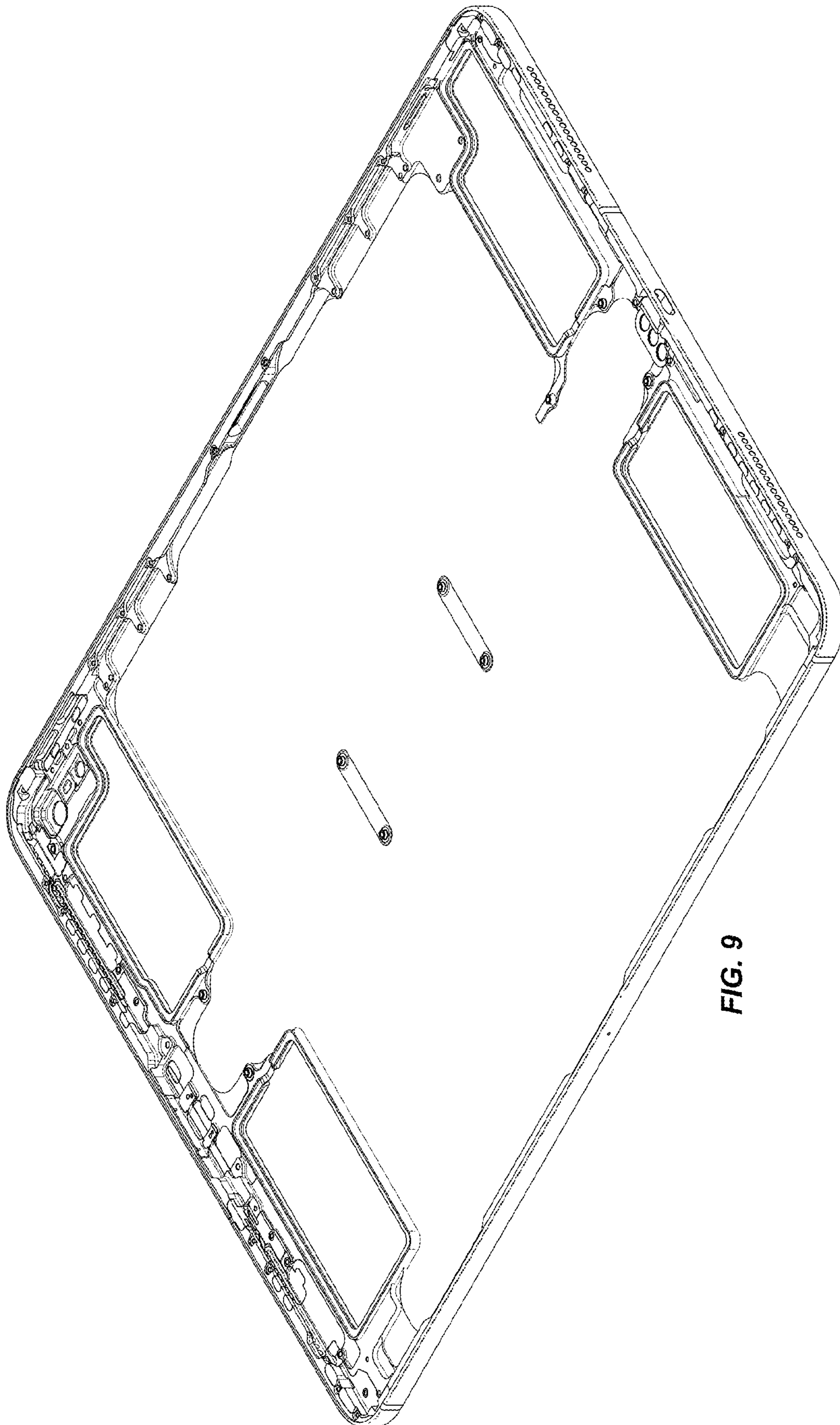
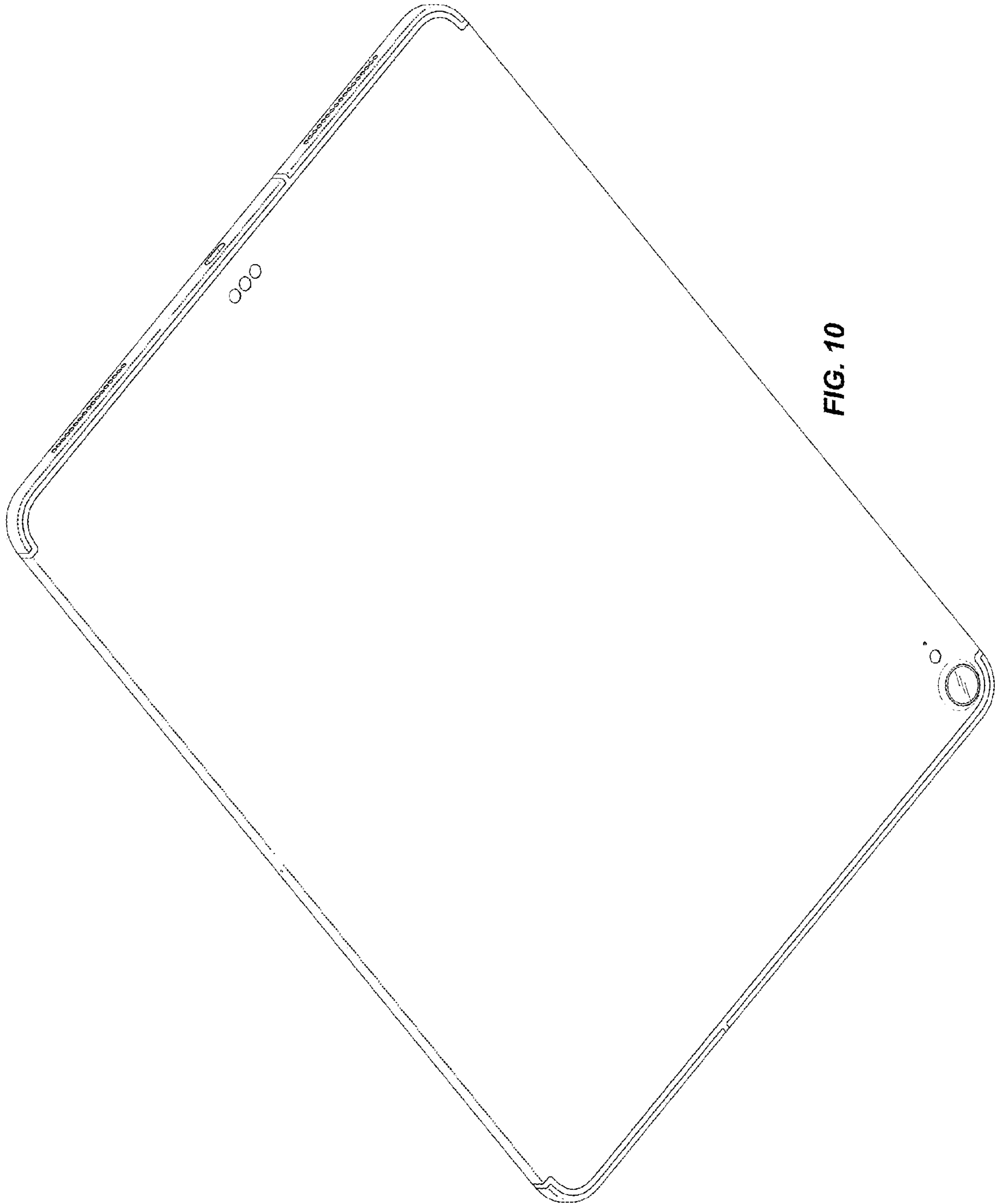

FIG. 9



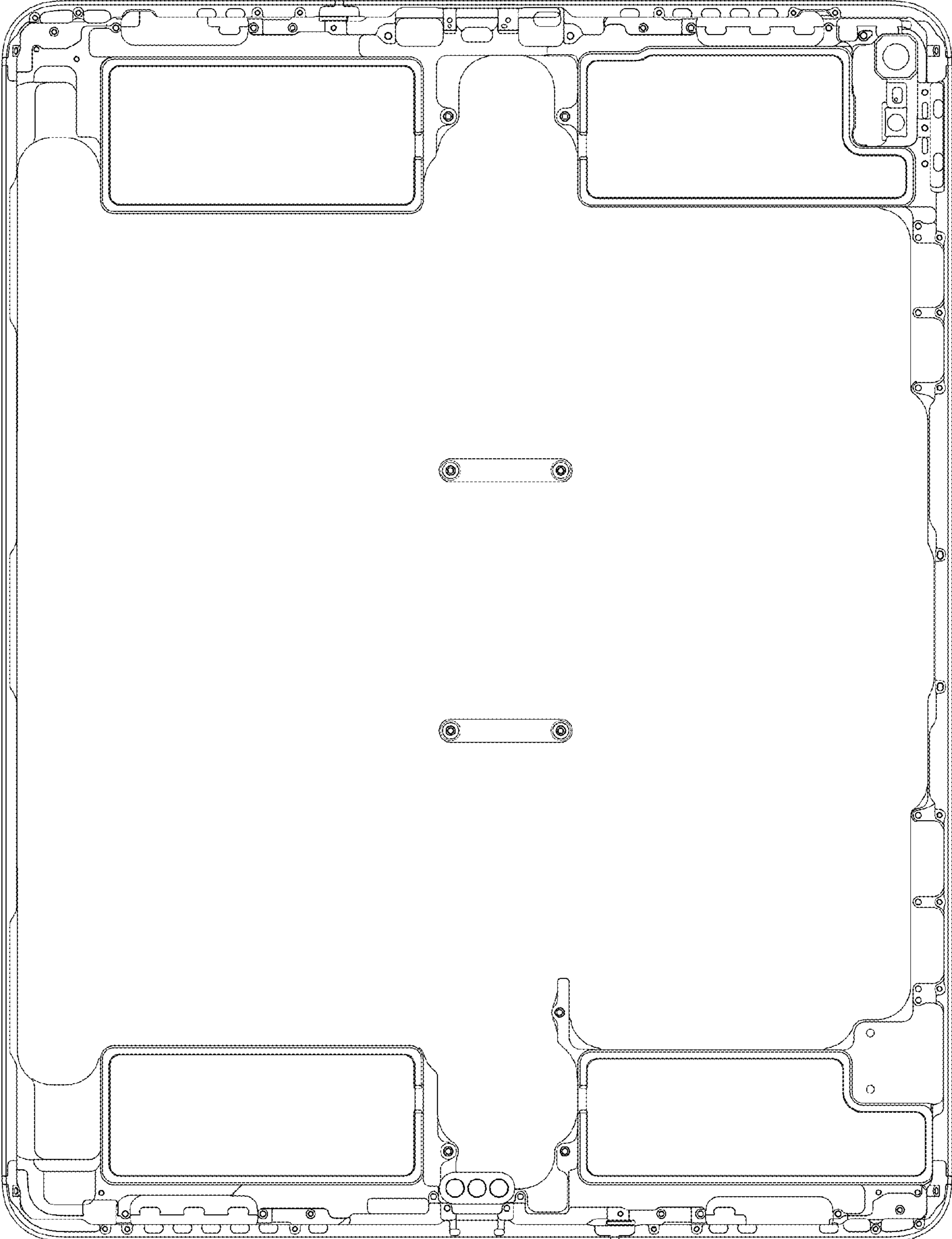
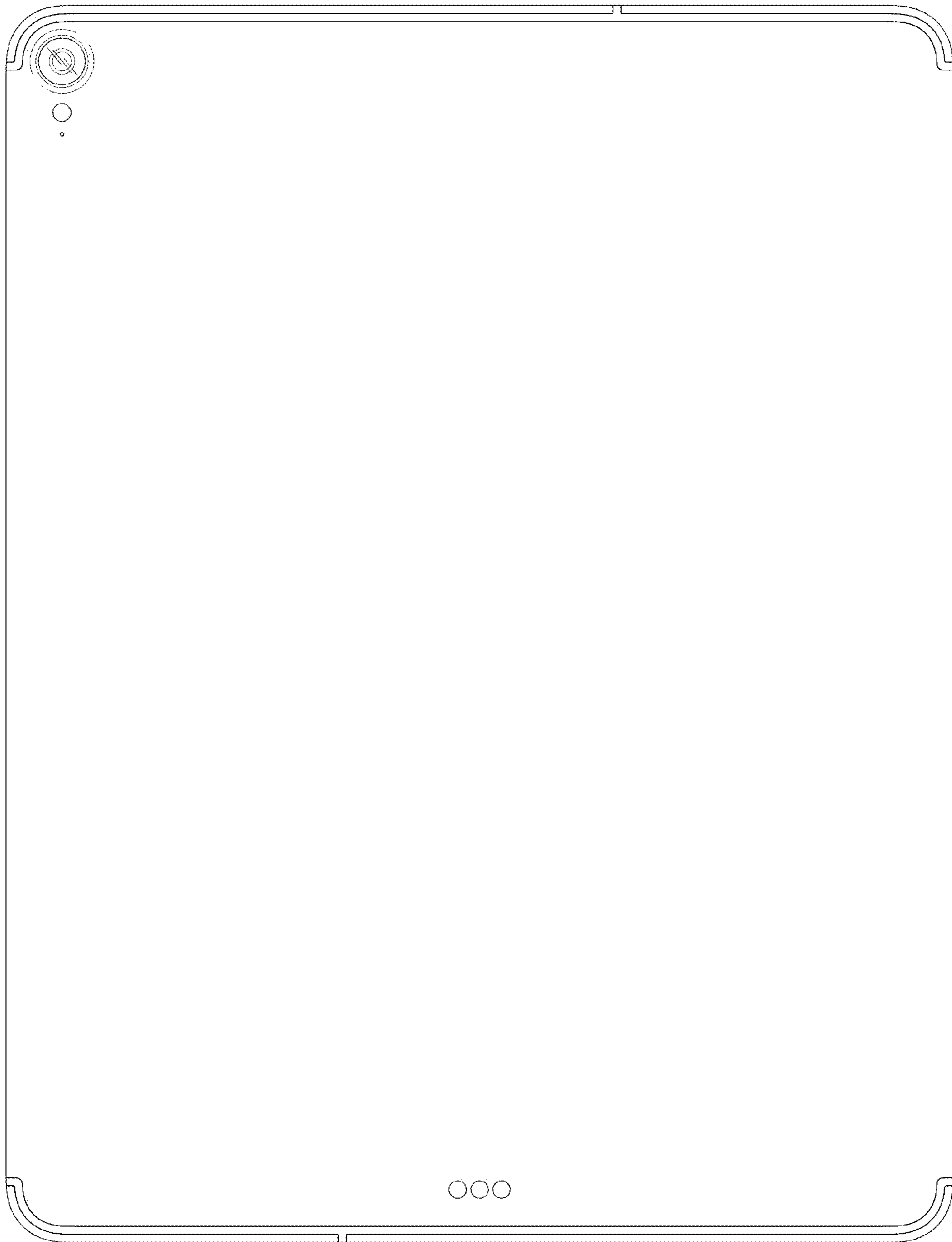
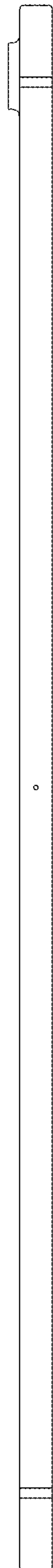

FIG. 11



**FIG. 12**



**FIG. 13**

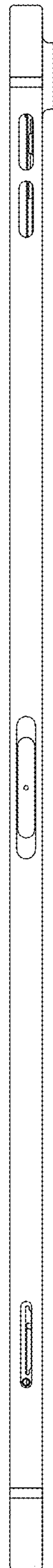

**FIG. 14**

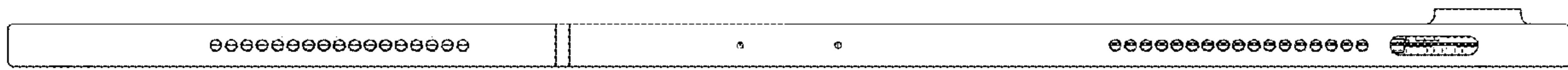

**FIG. 15**

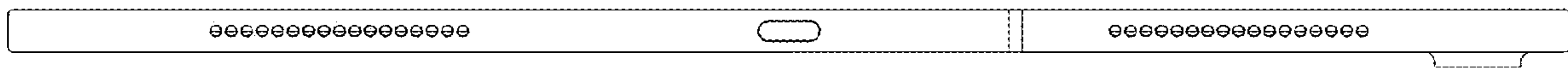

**FIG. 16**