



US00D909361S

(12) **United States Design Patent** (10) **Patent No.:** **US D909,361 S**  
**Kim** (45) **Date of Patent:** **\*\* Feb. 2, 2021**

(54) **CASE FOR ELECTRONIC COMMUNICATIONS DEVICE**

(71) Applicant: **SPIGEN KOREA CO., LTD.**, Seoul (KR)

(72) Inventor: **Seungjoo Kim**, Seoul (KR)

(73) Assignee: **SPIGEN KOREA CO., LTD.**, Seoul (KR)

(\*\*) Term: **15 Years**

(21) Appl. No.: **29/706,207**

(22) Filed: **Sep. 18, 2019**

(51) **LOC (13) Cl.** ..... **14-03**

(52) **U.S. Cl.**  
USPC ..... **D14/250**

(58) **Field of Classification Search**  
USPC ..... D14/440, 203.3–203.7, 439, 238.1, D14/251–253, 447, 217, 240, 248, 250; D3/201, 218, 247, 269, 273, 301, 303, D3/249; D13/103, 119, 107–108  
CPC ..... H04B 1/3888; H04M 1/0283; H04M 1/0202; A45C 1/06; A45C 11/00; A45C 13/02; A45C 2011/002; A45F 2005/026; A45F 2200/0525; A45F 2200/0516  
See application file for complete search history.

(56) **References Cited**

**U.S. PATENT DOCUMENTS**

- D606,305 S \* 12/2009 Lee ..... D3/269
- D636,755 S \* 4/2011 Chen ..... D14/138 AA
- D638,006 S 5/2011 Chang
- D654,491 S \* 2/2012 Melanson ..... D14/250
- D655,287 S 3/2012 de Jong et al.
- D655,288 S 3/2012 de Jong et al.
- D663,297 S 7/2012 de Jong et al.
- D666,824 S \* 9/2012 Phillips ..... D3/303

- D673,550 S \* 1/2013 Magness ..... D14/250
- D678,871 S 3/2013 Mishan et al.
- D679,692 S 4/2013 Fahrendorff et al.
- D679,698 S 4/2013 Murchison et al.
- D681,616 S \* 5/2013 Weller ..... D14/250

(Continued)

**OTHER PUBLICATIONS**

“Spigen Rugged Armor Designed for Apple iPhone Xs Case (2018) / Designed for Apple iPhone X Case (2017)—Matte Black”, <https://www.amazon.com/Spigen-Rugged-Armor-Designed-iPhone/dp/B074CNF6YW>, Earliest review date of Sep. 28, 2017, Downloaded on Jan. 15, 2019.

(Continued)

*Primary Examiner* — Carla J Wright

(74) *Attorney, Agent, or Firm* — Heedong Chae; Lucem, PC

(57) **CLAIM**

The ornamental design for a case for electronic communications device, as shown and described.

**DESCRIPTION**

FIG. 1 is a front perspective view of a case for electronic communications device showing my new design; FIG. 2 is a rear perspective view thereof; FIG. 3 is a front elevational view thereof; FIG. 4 is a rear elevational view thereof; FIG. 5 is a left side elevational view thereof; FIG. 6 is a right side elevational view thereof; FIG. 7 is a top plan view thereof; FIG. 8 is a bottom plan view thereof; and, FIG. 9 is an enlarged detail view of the encircled region in FIG. 2.

The dot-dash broken line circle in FIG. 2 delineates a portion of the case for electronic communications device that is part of the claimed design and that is shown on an enlarged scale in FIG. 9.

**1 Claim, 9 Drawing Sheets**

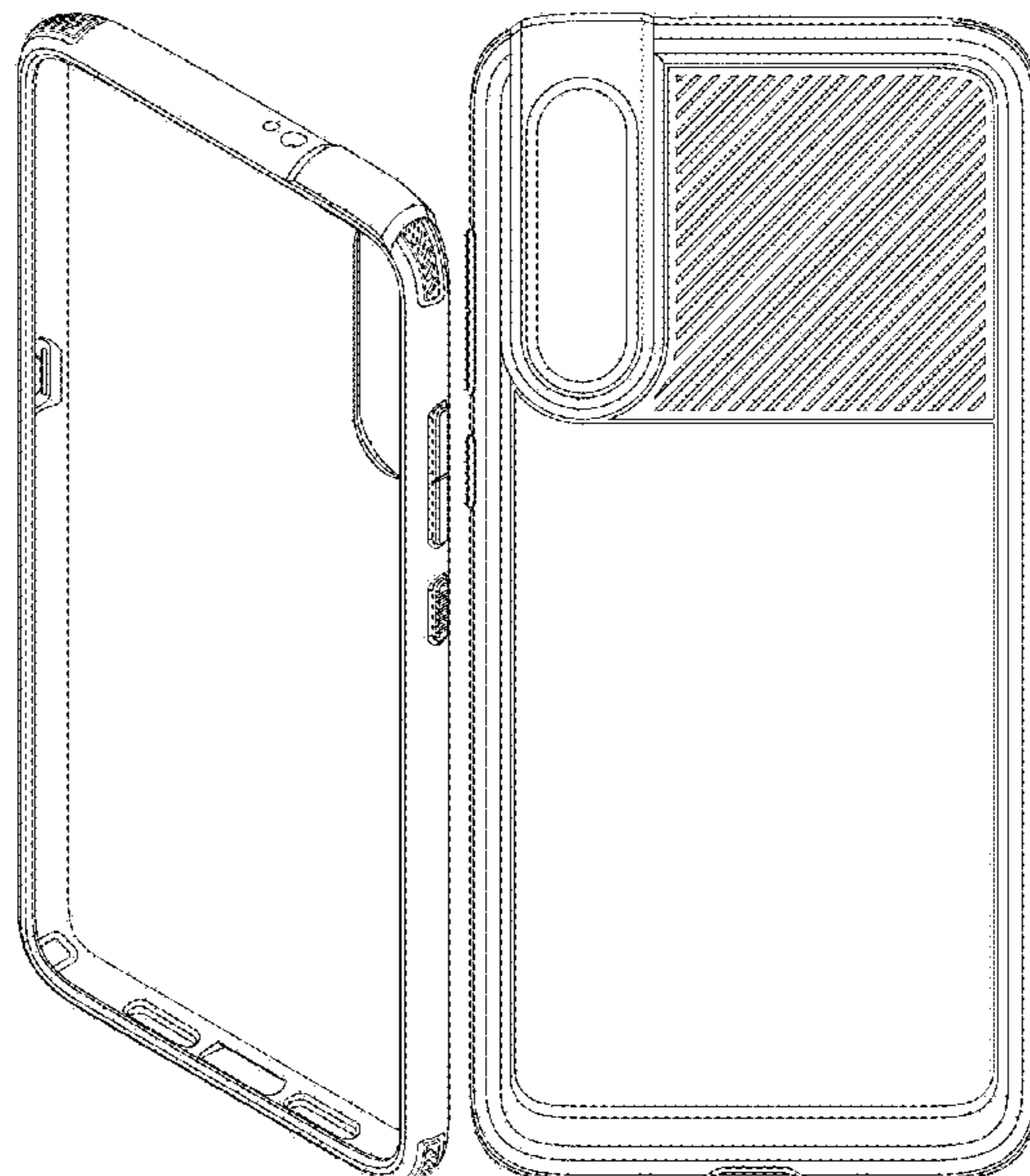



(56)

References Cited

U.S. PATENT DOCUMENTS

D681,617 S	5/2013	Weller et al.	
D683,340 S	5/2013	Chang et al.	
D684,150 S	6/2013	Goradesky et al.	
D693,350 S	* 11/2013	Mish .....	D14/440
D703,652 S	4/2014	Melanson et al.	
D703,654 S	4/2014	Melanson et al.	
D709,867 S	* 7/2014	Chang .....	D14/250
D714,276 S	9/2014	Hu et al.	
D716,783 S	11/2014	Loncar et al.	
D718,291 S	11/2014	Hong	
D751,058 S	* 3/2016	Cocchia .....	D14/250
D756,345 S	5/2016	Roberts et al.	
D757,699 S	* 5/2016	Lee .....	D14/248
D757,702 S	5/2016	Kanazawa	
D757,703 S	5/2016	Kanazawa	
D761,775 S	7/2016	Pan et al.	
D767,554 S	9/2016	Bertrand et al.	
D772,210 S	11/2016	Igarashi	
D772,211 S	11/2016	Poon et al.	
D772,213 S	11/2016	Daniel et al.	
D776,105 S	1/2017	Han	
D781,838 S	3/2017	Kim et al.	
D782,460 S	3/2017	Bertrand et al.	
D787,497 S	5/2017	Friedland et al.	
D800,105 S	10/2017	Roberts et al.	
D801,324 S	10/2017	Kim	
D809,454 S	* 2/2018	Zhou .....	D13/103
D812,600 S	3/2018	Altaras	
D812,618 S	* 3/2018	Altaras .....	D14/440
D812,619 S	3/2018	Altaras	
D813,215 S	3/2018	Banerjee et al.	
D816,074 S	4/2018	Deng	
D816,651 S	5/2018	Chiang et al.	
D816,654 S	5/2018	Chen	
D820,246 S	6/2018	Li et al.	
D830,353 S	10/2018	Kim et al.	
D831,636 S	10/2018	Zhu	
D832,833 S	11/2018	Kim	
D837,194 S	1/2019	Roberts et al.	
D838,262 S	1/2019	Witter et al.	
D839,862 S	2/2019	Hyun	
D840,991 S	2/2019	Kim	
D840,992 S	* 2/2019	Kim .....	D14/250
D841,637 S	* 2/2019	Kim .....	D14/250
D842,292 S	3/2019	Ahn	
D842,848 S	* 3/2019	Kim .....	D14/250
D844,597 S	* 4/2019	Ahn .....	D14/250
D845,292 S	* 4/2019	Fitzgerald .....	D14/250
D849,734 S	* 5/2019	Wu .....	D14/250
D850,453 S	* 6/2019	Wu .....	D14/440
D853,371 S	7/2019	Wei	
D853,372 S	* 7/2019	Kim .....	D14/250
D855,046 S	7/2019	Wei	
D855,610 S	8/2019	Wei	
D857,682 S	8/2019	Wang	
D857,685 S	* 8/2019	Ahn .....	D14/250
D861,662 S	* 10/2019	Ahn .....	D14/250
D864,181 S	10/2019	Luo	
D880,469 S	* 4/2020	Lee .....	D14/250
2017/0123217 A1	* 5/2017	Dukerschein .....	G02B 30/37

OTHER PUBLICATIONS

“Spigen Rugged Armor iPhone X Case with Resilient Shock Absorption and Carbon Fiber Design for Apple iPhone X (2017)—Matte Black”, <https://www.amazon.com/dp/B074CNF6YW>, Earliest review date of Sep. 28, 2017, Downloaded on Jul. 17, 2018.

“Spigen Rugged Armor LG V30 with Resilient Shock Absorption and Carbon Fiber Design for LG V30 (2017)—Black”, <https://www.amazon.com/dp/B071JV1L9Z>, Earliest review date of Oct. 5, 2017, Downloaded on Jul. 17, 2018.

“Spigen Rugged Armor Google Pixel 2 Case with Resilient Shock Absorption and Carbon Fiber Design for Google Pixel 2 (2017)—

Black”, <https://www.amazon.com/Spigen-Rugged-Google-Resilient-Absorption/dp/B07471C38C>, Earliest review date of Oct. 10, 2017, Downloaded on Jan. 5, 2019.

“Spigen Rugged Armor Google Pixel 2 Case with Resilient Shock Absorption and Carbon Fiber Design for Google Pixel 2 (2017)—Black”, <https://www.amazon.com/dp/B07471C38C>, Earliest review date of Oct. 10, 2017, Downloaded on Jan. 17, 2018.

“Spigen Rugged Armor Google Pixel 2 XL Case with Resilient Shock Absorption and Carbon Fiber Design for Google Pixel 2 XL (2017)—Black”, <https://www.amazon.com/Spigen-Rugged-Google-Resilient-Absorption/dp/B07475TXJQ>, Earliest review date of Oct. 11, 2017, Downloaded on Jan. 5, 2019.

“Spigen Rugged Armor Moto X4 Case with Resilient Shock Absorption and Carbon Fiber Design for Moto X4—Black”, <https://www.amazon.com/dp/B072N3WT4J>, Earliest review date of Oct. 22, 2017, Downloaded on Jul. 17, 2018.

“Spigen Rugged Armor Galaxy A8 (2016) Case with Resilient Shock Absorption and Carbon Fiber Design for Galaxy A8 (2016)—Black”, <https://www.amazon.com/dp/B01M26EX8X>, Earliest review date of Oct. 25, 2017, Downloaded on Jan. 17, 2018.

“Spigen Rugged Armor ZTE Axon 7 Case with Resilient Shock Absorption and Carbon Fiber Design for ZTE Axon 7—Black”, <https://www.amazon.com/dp/B01DCS2BQW>, Earliest review date of Nov. 22, 2017, Downloaded on Jul. 18, 2018.

“Spigen Rugged Armor Sony Xperia XZ1 Case with Resilient Shock Absorption and Carbon Fiber Design for Sony Kperia XZ1 (2017)—Black”, <https://www.amazon.com/dp/B075DRB8TX>, Earliest review date of Nov. 22, 2017, Downloaded on Jul. 18, 2018.

“Spigen Rugged Armor Huawei Honor 7X Case/Huawei Mate SE Case with Resilient Shock Absorption and Carbon Fiber Design for Huawei Honor 7X (2017)/Huawei Mate SE (2018)—Black”, <https://www.amazon.com/dp/B076V3D2F5>, Earliest review date of Dec. 19, 2017, Downloaded on Jul. 18, 2018.

“Spigen Rugged Armor OnePlus 5T Case with Resilient Shock Absorption and Carbon Fiber Design for OnePlus 5T (2017)—Black”, <https://www.amazon.com/dp/B077H6RVD6>, Earliest review date of Dec. 25, 2017, Downloaded on Jan. 17, 2018.

“Spigen Rugged Armor Honor 9 Case with Resilient Shock Absorption and Carbon Fiber Design for Honor 9—Black”, <https://www.amazon.com/dp/B071GPHBFF>, Earliest review date of Jan. 2, 2018, Downloaded on Jul. 18, 2018.

“Spigen Rugged Armor Galaxy J3 Prime case/Galaxy J3 Luna Pro case/Galaxy J3 Emerge Case with Resilient Shock Absorption and Carbon Fiber Design for Galaxy J3 Emerge/Galaxy J3/J3 2017—Black”, <https://www.amazon.com/dp/B0746RC5BJ>, Earliest review date of Jan. 5, 2018, Downloaded on Jul. 17, 2018.

“Spigen Rugged Armor Honor 5X Case with Resilient Shock Absorption and Carbon Fiber Design for Huawei Honor 5X—Black”, <https://www.amazon.com/dp/B01DJHHD2>, Earliest review date of Jan. 22, 2018, Downloaded on Jul. 18, 2018.

“Spigen Rugged Armor Razer Phone Case with Flexible and Durable Shock Absorption with Carbon Fiber Design for Razer Phone (2017)—Black”, <https://www.amazon.com/dp/B078KJQH5V>, Earliest review date of Feb. 8, 2018, Downloaded on Jul. 17, 2018.

“Spigen Rugged Armor Galaxy S9 Case with Flexible and Durable Shock Absorption with Carbon Fiber Design for Samsung Galaxy S9 (2018) —Matte Black”, <https://www.amazon.com/dp/B078BJQMPG>, Earliest review date of Mar. 3, 2018, Downloaded on Jul. 17, 2018.

“Spigen Rugged Armor Galaxy S9 Plus Case with Flexible and Durable Shock Absorption with Carbon Fiber Design for Samsung Galaxy S9 Plus (2018)—Matte Black”, <https://www.amazon.com/dp/B0789S2MPW>, Earliest review date of Mar. 9, 2018, Downloaded on Jul. 17, 2018.

“Spigen Rugged Armor Mi A1 /Mi 5X Case with Flexible and Durable Shock Absorption with Carbon Fiber Design for Xiaomi Mi A1 /Mi SX (2017)—Black”, <https://www.amazon.com/dp/B078Z531CZ>, Earliest review date of Mar. 19, 2018, Downloaded on Jul. 18, 2018.

“Spigen Rugged Armor Designed for LG G7 ThinQ Case (2018)—Black”, <https://www.amazon.com/Spigen-Rugged-Armor-Designed-ThinQ/dp/B078MVT3GJ>, Earliest review date of Jun. 2, 2018, Downloaded on Jan. 15, 2019.



(56)

## References Cited

## OTHER PUBLICATIONS

“Spigen Rugged Armor Moto G6 Case with Flexible and Durable Shock Absorption with Carbon Fiber Design for Motorola Moto G6 (2018)—Black”, <https://www.amazon.com/Spigen-Flexible-Durable-Absorption-Motorola/dp/B079LS3T4T>, Earliest review date of Jun. 11, 2018, Downloaded on Jan. 15, 2019.

“Spigen Rugged Armor Moto G5S Plus Case with Resilient Shock Absorption and Carbon Fiber Design for Moto G5S Plus—Black”, <https://www.amazon.com/dp/B0731QBBYY>, Earliest review date of Jul. 3, 2018, Downloaded on Jan. 15, 2019.

“Spigen Rugged Armor Design for Apple iPad 9/ Case iPad Case (2017/2018)—Black”, <https://www.amazon.com/Spigen-Rugged-Armor-Design-Apple/dp/B07CTZS3KJ>, Earliest review date of Jul. 25, 2018, Downloaded on Jan. 15, 2019.

“Spigen Rugged Armor Galaxy J7 Refine Case/Galaxy J7 2018 Case/Galaxy J7 Star Case with Flexible and Durable Shock Absorption with Carbon Fiber Design for Samsung Galaxy J7 (2018)—Black”, <https://www.amazon.com/Spigen-Flexible-Durable-Absorption-Samsung/dp/B07DHPIWZ>, Earliest review date of Aug. 7, 2018, Downloaded on Jan. 15, 2019.

“Spigen Rugged Armor LG Stylo 4 Phone Case/LG Stylo 4 Case/Q Stylus Case/LG Stylo 4 Case with Flexible and Durable Shock Absorption with Carbon Fiber Design for LG Stylo 4 (2018)—Black”, <https://www.amazon.com/Spigen-Rugged-Flexible-Durable-Absorption/dp/B07DHTHL8G>, Earliest review date of Aug. 12, 2018, Downloaded on Jan. 15, 2019.

“Spigen Rugged Armor Galaxy Note 9 Case with Resilient Shock Absorption and Carbon Fiber Design for Galaxy Note 9 (2018)—Matte Black”, <https://www.amazon.com/Spigen-Rugged-Galaxy-Resilient-Absorption/dp/B07FLXM5KJ>, Earliest review date of Aug. 14, 2018, Downloaded on Jan. 15, 2019.

“Spigen Rugged Armor Moto Z3 / Moto Z3 Play Case with Air Cushion Technology for Motorola Moto Z3 / Moto Z3 Play (2018)—Black”, <https://www.amazon.com/Spigen-Rugged-Cushion-Technology-Motorola/dp/B07DRXMCZ3>, Earliest review date of Aug. 25, 2018, Downloaded on Jan. 15, 2019.

“Samsung Galaxy J7 Unicorn Beetle Pro Full Body Rugged Holster Case”, <https://www.i-blason.com/samsung-galaxy-7-unicorn-beetle-pro-case>, Earliest review date of Dec. 14, 2017, Downloaded on Aug. 8, 2019.

“Caseology Vault for Samsung Galaxy S7 Case (2016)—Black: Caseology”, <https://www.amazon.com/dp/B07DRXMCZ3>, Earliest review date of Mar. 9, 2016, Downloaded on Jan. 16, 2020.

“Caseology Vault for Apple iPhone 8 Case (2017) / for iPhone 7 Case (2016)—Rugged & Flexible—Matte Black”, <https://www.amazon.com/dp/B01JSZOJ7M>, Earliest review date of Sep. 10, 2016, Downloaded on Jan. 16, 2020.

“Caseology Vault for Apple iPhone 7 Plus Case (2016)—Rugged Matte Finish—Black”, <https://www.amazon.com/dp/B01N2OCQV4>, Earliest review date of Dec. 16, 2016, Downloaded on Jan. 16, 2020.

“Caseology Vault Designed for Apple Watch Series 2 Case 38mm (2015)—Matte Black”, <https://www.amazon.com/dp/B01N4E4P0D>, Earliest review date of Jan. 5, 2017, Downloaded on Jan. 16, 2020.

“Caseology Vault for Samsung Galaxy S8 Plus Case (2017)—Black”, <https://www.amazon.com/dp/B06XJB79BM>, Earliest review date of Apr. 3, 2017, Downloaded on Jan. 16, 2020.

“Caseology Vault I for Samsung Galaxy S8 Case (2017)—Black”, <https://www.amazon.com/dp/B06XJDMFK3>, Earliest review date of Apr. 20, 2017, Downloaded on Jan. 16, 2020.

“Caseology Vault for Samsung Galaxy Note 8 Case (2017)—Black”, <https://www.amazon.com/dp/B06XJDMFK3>, Earliest review date of Aug. 31, 2017, Downloaded on Jan. 16, 2020.

“Caseology Vault for Apple iPhone 8 Case (2017)—Rugged Matte Finish—Black”, <https://www.amazon.com/dp/B075345DKH/>, Earliest review date of Oct. 14, 2017, Downloaded on Jan. 16, 2020.

“Caseology Vault for Google Pixel 2 XL Case (2017)—Rugged Matte Finish—Black”, <https://www.amazon.com/dp/B075RVL499/>, Earliest review date of Oct. 14, 2017, Downloaded on Jan. 16, 2020.

“Caseology Vault for iPhone XS Case (2018) / iPhone X Case (2017)—Rugged Matte Finish—Black”, <https://www.amazon.com/dp/B07533BBZ4>, Earliest review date of Oct. 26, 2017, Downloaded on Jan. 16, 2020.

“Caseology Vault Designed for Apple Watch Series 3 Case 38mm (2017)—Matte Black”, <https://www.amazon.com/dp/B076YP62PV>, Earliest review date of Nov. 28, 2017, Downloaded on Jan. 16, 2020.

“Caseology Vault for Galaxy S9 Plus Case (2018)—Rugged Matte Finish—Burgundy”, <https://www.amazon.com/dp/B07995SB3C>, Earliest review date of Nov. 28, 2017, Downloaded on Jan. 16, 2020.

“Caseology Vault for Apple iPhone 8 Case (2017) / for iPhone 7 Case (2016)—Rugged & Flexible—Matte Black”, <https://www.amazon.com/dp/B0USZOJ7M>, Earliest review date of Sep. 10, 2016, Downloaded on Jan. 16, 2020.

“The best iPhone 7 & 7 Plus cases available now”, <https://9to5mac.com/2016/09/07/best-iphone-7-7-plus-cases-accessories-available-now/>, Earliest review date of Sep. 17, 2016, Downloaded on Mar. 18, 2020.

“Caseology Vault for Google Pixel Case (2016)—Rugged & Flexible—Black”, <https://www.amazon.com/dp/B01MEDIMGS>, Earliest review date of Nov. 10, 2016, Downloaded on Jan. 16, 2020.

“Caseology Vault for LG G6 Case (2017)—Rugged Matte Finish—Black”, <https://www.amazon.com/dp/B06W52JLH>, Earliest review date of Mar. 28, 2017, Downloaded on Jan. 16, 2020.

“Caseology Nero Tough for iPhone 8 Plus Case (2017) / iPhone 7 Plus Case (2016)—360 Protection—Black”, <https://www.amazon.com/dp/B07534JMM2>, Earliest review date of Aug. 23, 2017, Downloaded on Nov. 19, 2019.

“Spigen Rugged Armor Galaxy S6 Case with Resilient Shock Absorption and Carbon Fiber Design for Galaxy S6 2015—Black”, <https://www.amazon.com/dp/B00T6P05ZK>, Earliest review date of Mar. 10, 2015, Downloaded on Jul. 17, 2018.

“Spigen Rugged Armor Galaxy S6 Edge Case with Flexible and Durable Shock Absorption with Carbon Fiber Design for Samsung Galaxy S6 Edge (2015)—Black”, <https://www.amazon.com/dp/B00SVCITW0>, Earliest review date of Mar. 13, 2015, Downloaded on Jul. 17, 2018.

“Spigen Rugged Armor Galaxy Note 5 Case with Resilient Shock Absorption and Carbon Fiber Design for Galaxy Note 5 2015—Black”, <https://www.amazon.com/dp/B010MWFUBY>, Earliest review date of Aug. 23, 2015, Downloaded on Jul. 17, 2018.

“Spigen Rugged Armor iPhone 6S Case with Resilient Shock Absorption and Carbon Fiber Design for iPhone 6S/iPhone 6—Black”, <https://www.amazon.com/dp/B010MVJM5K>, Earliest review date of Sep. 3, 2015, Downloaded on Jul. 17, 2018.

“Spigen Rugged Armor iPhone 6S Plus Case with Resilient Shock Absorption and Carbon Fiber Design for iPhone 6S Plus 2015—Black”, <https://www.amazon.com/dp/B010MVR76Q>, Earliest review date of Sep. 7, 2015, Downloaded on Jul. 17, 2018.

“Spigen Tough Armor Tech iPhone 6S Case with Extreme Shock and Drop Protection for Apple iPhone 6 / 6S—Gunmetal”, <https://www.amazon.com/Spigen-Tough-iPhone-Extreme-Protection/dp/B013TKNSIS>, Earliest review date of Oct. 3, 2015, Downloaded on Jan. 15, 2019.

“Spigen Rugged Armor Samsung Galaxy S7 Case with Resilient Shock Absorption and Carbon Fiber Design for Samsung Galaxy S7 2016—Black”, <https://www.amazon.com/Spigen-Rugged-Designed-Samsung-Galaxy/dp/B01A7ICVVT>, Earliest review date of Feb. 25, 2016, Downloaded on Jul. 17, 2018.

“Spigen Rugged Armor Galaxy S7 Edge Case with Flexible and Durable Shock Absorption with Carbon Fiber Design for Samsung Galaxy S7 Edge (2016)—Black”, <https://www.amazon.com/Spigen-Rugged-Designed-Samsung-Galaxy/dp/B01A7IDHOU>, Earliest review date of Feb. 28, 2016, Downloaded on Jul. 17, 2018.

“Spigen Rugged Armor Galaxy A5 Case with Resilient Shock Absorption and Carbon Fiber Design for Galaxy A5—Black”, <https://www.amazon.com/Spigen-Rugged-Designed-Samsung-Galaxy/dp/B018J07A46>, Earliest review date of Mar. 18, 2016, Downloaded on Jul. 17, 2018.

“Spigen Rugged Armor iPhone SE Case with Resilient Shock Absorption and Carbon Fiber Design for iPhone SE 2016—Black”,



(56)

## References Cited

## OTHER PUBLICATIONS

<https://www.amazon.com/Spigen-Rugged-iPhone-Resilient-Absorption/dp/B01BEDNUDK>, Earliest review date of Apr. 10, 2016, Downloaded on Jan. 15, 2019.

“Spigen Rugged Armor Honor 5X Case with Resilient Shock Absorption and Carbon Fiber Design for Huawei Honor 5X—Black”, <https://www.amazon.com/Spigen-Rugged-Resilient-Absorption-Carbon/dp/B01DJHDXD2>, Earliest review date of May 1, 2016, Downloaded on Jan. 15, 2019.

“Spigen Rugged Armor HTC 10 Case with Resilient Shock Absorption and Carbon Fiber Design for HTC 10 2016—Black”, <https://www.amazon.com/dp/B01DAN1T4E>, Earliest review date of May 4, 2016, Downloaded on Jul. 18, 2018.

“Spigen Rugged Armor Huawei P8 Lite Case with Resilient Shock Absorption and Carbon Fiber Design for Huawei P8 Lite (2015)—Black”, <https://www.amazon.com/dp/B01DL0DME6>, Earliest review date of Jun. 1, 2016, Downloaded on Jul. 18, 2018.

“Spigen Rugged Armor OnePlus 3 Case/OnePlus 3T Case with Resilient Shock Absorption and Carbon Fiber Design for OnePlus 3 2016—Black”, <https://www.amazon.com/dp/B01H3PEWDK>, Earliest review date of Jul. 28, 2016, Downloaded on Jul. 17, 2018.

“Spigen Rugged Armor iPhone 8 Case / iPhone 7 Case with Resilient Shock Absorption and Carbon Fiber Design for Apple iPhone 8 (2017) / iPhone 7 (2016)—Black”, <https://www.amazon.co.uk/Spigen-Rugged-iPhone-Resilient-Absorption/dp/B01GIVX7TA>, Earliest review date of Aug. 2, 2016, downloaded on Oct. 24, 2018.

“Spigen Rugged Armor iPhone 8 Plus/iPhone 7 Plus Case with Resilient Shock Absorption and Carbon Fiber Design for Apple iPhone 8 Plus (2017)/iPhone 7 Plus (2016)—Black”, <https://www.amazon.com/dp/B01GIWGAAC>, Earliest review date of Sep. 2, 2016, Downloaded on Jul. 17, 2018.

“Spigen Rugged Armor Huawei P9 Lite Case with Resilient Shock Absorption and Carbon Fiber Design for Huawei P9 Lite—Black”, <https://www.amazon.com/B01DL0DJGM>, Earliest review date of Sep. 6, 2016, Downloaded on Jul. 18, 2018.

“Spigen Rugged Armor iPhone 8 Case/iPhone 7 Case with Resilient Shock Absorption and Carbon Fiber Design for Apple iPhone 8 (2017)/iPhone 7 (2016) —Black”, <https://www.amazon.com/dp/B01GIVX7TA>, Earliest review date of Sep. 11, 2016, Downloaded on Jul. 17, 2018.

“Spigen Rugged Armor Google Pixel XL Case with Resilient Shock Absorption and Carbon Fiber Design for Google Pixel XL 2016—Black”, <https://www.amazon.com/dp/B01M1EEXWJ>, Earliest review date of Oct. 2, 2016, Downloaded on Jul. 17, 2018.

“Spigen Rugged Armor LG V20 Case with Resilient Shock Absorption and Carbon Fiber Design for LG V20 2016 Black—”, <https://www.amazon.com/dp/B01M0HW9P4>, Earliest review date of Oct. 19, 2016, Downloaded on Jul. 18, 2018.

“Spigen Rugged Armor Honor 8 Case with Resilient Shock Absorption for Huawei Honor 8 2016—Black”, <https://www.amazon.com/dp/B01LXTROW1>, Earliest review date of Oct. 20, 2016, Downloaded on Jul. 18, 2018.

“Spigen Rugged Armor Moto Z Droid Case with Resilient Shock Absorption and Carbon Fiber Design for Moto Z Droid 2016—Black”, <https://www.amazon.com/dp/B01HCAQMBQ>, Earliest review date of Dec. 9, 2016, Downloaded on Jul. 17, 2018.

“Spigen Rugged Armor Galaxy A3 2016 Case with Resilient Shock Absorption and Carbon Fiber Design for Galaxy A3 2016—Black”, <https://www.amazon.com/Spigen-Rugged-Armor-Samsung-Galaxy/dp/B01HFMYLIC>, Earliest review date of Dec. 18, 2016, Downloaded on Jul. 17, 2018.

“Spigen Rugged Armor ZenFone 3 Max Case (ZC520TL) with Resilient Shock Absorption and Carbon Fiber Design for ASUS ZenFone 3 Max (ZC520TL)—Black”, <https://www.amazon.com/dp/B01MSDJQ7C>, Earliest review date of Mar. 9, 2017, Downloaded on Jul. 18, 2018.

“Spigen Rugged Armor Extra Designed for LG G6 Case (2017) / Designed for LG G6 Plus (2017)—Black”, <https://www.amazon.com/Spigen-Rugged-Resilient-Absorption-Carbon/dp/B01N6T9PHS>, Earliest review date of Mar. 28, 2017, Downloaded on Jan. 9, 2020.

“Spigen Rugged Armor LG G6 Case/G6 Plus Case with Resilient Shock Absorption and Carbon Fiber Design for LG G6/G6 Plus (2017)—Black”, <https://www.amazon.com/dp/B01MUCZILA>, Earliest review date of Mar. 30, 2017, Downloaded on Jul. 18, 2018.

“Spigen Rugged Armor Galaxy S8 Plus Case with Resilient Shock Absorption and Carbon Fiber Design for Galaxy S8 Plus (2017)—Black”, <https://www.amazon.com/Spigen-Rugged-Designed-Samsung-Galaxy/dp/B06XNW4ZVJ>, Earliest review date of Apr. 3, 2017, Downloaded on Jul. 17, 2018.

“Spigen Rugged Armor Galaxy S8 Case with Resilient Shock Absorption and Carbon Fiber Design for Samsung Galaxy S8 (2017)—Black”, <https://www.amazon.com/Spigen-Rugged-Designed-Samsung-Galaxy/dp/B06XNNJ4KM>, Earliest review date of Apr. 7, 2017, Downloaded on Jul. 17, 2018.

Spigen, “Spigen Rugged Armor Extra”, <https://www.youtube.com/watch?v=ILUEjn1P2hk>, Published May 26, 2017, downloaded on Jan. 9, 2020.

“Spigen Rugged Armor Huawei P10 Plus Case with Resilient Shock Absorption and Carbon Fiber Design for Huawei P10 Plus(2017)—Rugged Armor”, <https://www.amazon.com/dp/B06XFZW779>, Earliest review date of May 26, 2017, Downloaded on Jul. 18, 2018.

“Spigen Rugged Armor Galaxy J7 2017 Case, J7 Prime, J7 2017(AT &T), J7 Sky Pro, J7 Perx case with Resilient Shock Absorption and Carbon Fiber Design for Samsung Galaxy J7 V 2017—Black”, <https://www.amazon.com/Spigen-Rugged-Resilient-Absorption-Samsung/dp/B06WRRF36B>, Earliest review date of May 31, 2017, Downloaded on Jan. 15, 2019.

“Spigen Rugged Armor Huawei P10 Lite Case with Resilient Shock Absorption and Carbon Fiber Design for Huawei P10 Lite (2017)—Black”, <https://www.amazon.com/dp/B06XCNQ3S4>, Earliest review date of Jun. 7, 2017, Downloaded on Jul. 18, 2018.

“Spigen Rugged Armor Huawei P10 Case with Resilient Shock Absorption and Carbon Fiber Design for Huawei P10 (2017)—Black”, <https://www.amazon.com/dp/B06XCTQR1W>, Earliest review date of Jun. 8, 2017, Downloaded on Jul. 18, 2018.

“Spigen Rugged Armor HTC U11 Case with Resilient Shock Absorption and Carbon Fiber Design for HTC U 11 (2017)—Black”, <https://www.amazon.com/dp/B07234FLGX>, Earliest review date of Jun. 17, 2017, Downloaded on Jul. 18, 2018.

“Spigen Rugged Armor Huawei P8 Lite 2017 Case with Resilient Shock Absorption and Carbon Fiber Design for Huawei P8 Lite (2017)/nova lite/P9 lite 2017/Honor 8 lite—Black”, <https://www.amazon.com/dp/B06XFVXMLN>, Earliest review date of Jun. 24, 2017, Downloaded on Jul. 18, 2018.

“Spigen Rugged Armor Extra Galaxy Temp Case with Resilient Shock Absorption and Carbon Fiber Design for Galaxy Temp (2017)—Black”, <https://www.amazon.com/Spigen-Rugged-Galaxy-Resilient-Absorption/dp/B01MTEQVNB>, Earliest review date of Jul. 6, 2017, downloaded on Jan. 9, 2020.

“Spigen Rugged Armor Sony Xperia XZ Premium Case with Resilient Shock Absorption and Carbon Fiber Design for Sony Xperia XZ Premium (2017)—Black”, <https://www.amazon.com/dp/B072PRXPQC>, Earliest review date of Jul. 14, 2017, Downloaded on Jul. 18, 2018.

“Spigen Rugged Armor OnePlus 5 Case with Resilient Shock Absorption and Carbon Fiber Design for OnePlus 5 (2017)—Black”, <https://www.amazon.com/dp/B06XG19W3G>, Earliest review date of Jul. 25, 2017, Downloaded on Jul. 17, 2018.

“Spigen Rugged Armor Moto Z2 Play Case with Resilient Shock Absorption and Carbon Fiber Design for Moto Z2 Play Black”, <https://www.amazon.com/dp/B071WR4H9V>, Earliest review date of Jul. 27, 2017, Downloaded on Jul. 17, 2018.

“Spigen Rugged Armor Galaxy Note 8 Case with Resilient Shock Absorption and Carbon Fiber Design for Galaxy Note 8 (2017)—Matte Black”, <https://www.amazon.com/Spigen-Rugged-Galaxy-Resilient-Absorption/dp/B073RWJ6Z7>, Earliest review date of Aug. 26, 2017, Downloaded on Jan. 15, 2019.

“Spigen Rugged Armor Galaxy Note 8 Case with Resilient Shock Absorption and Carbon Fiber Design for Galaxy Note 8 (2017)—Matte Black”, <https://www.amazon.com/Spigen-Rugged-Designed->



(56)

**References Cited**

OTHER PUBLICATIONS

Samsung-Galaxy/dp/B073RWJ6Z7, Earliest review date of Aug. 26, 2017, Downloaded on Jul. 17, 2018.

“Spigen Rugged Armor Moto E4 Case with Resilient Shock Absorption and Carbon Fiber Design for Moto E4 (2017)—Black”, <https://www.amazon.com/Spigen-Rugged-Armor-Designed-Motorola/dp/B073RVC6YY>, Earliest review date of Sep. 5, 2017, Downloaded on Jul. 17, 2018.

“Spigen Rugged Armor Extra Designed for Apple iPhone 7 Case (2016)—Black”, <https://www.amazon.com/Spigen-Rugged-iPhone-Resilient-Absorption/dp/B06XC8WL7P>, Earliest review date of Sep. 7, 2017, downloaded on Jan. 9, 2020.

“Spigen Rugged Armor Moto Z2 Force Case with Resilient Shock Absorption and Carbon Fiber Design for Moto Z2 Force (2017)—Black”, <https://www.amazon.com/Spigen-Rugged-Resilient-Absorption-Carbon/dp/B074BCC6K7>, Earliest review date of Sep. 23, 2017, downloaded on Jul. 17, 2018.

“Spigen Rugged Armor OnePlus 6 Case with Flexible and Durable Shock Absorption with Carbon Fiber Design for OnePlus 6 (2018)—Black”, <https://www.amazon.com/dp/K06CS23358>, Earliest review date of Jun. 22, 2018, Downloaded on Jul. 17, 2018.

\* cited by examiner

FIG. 1

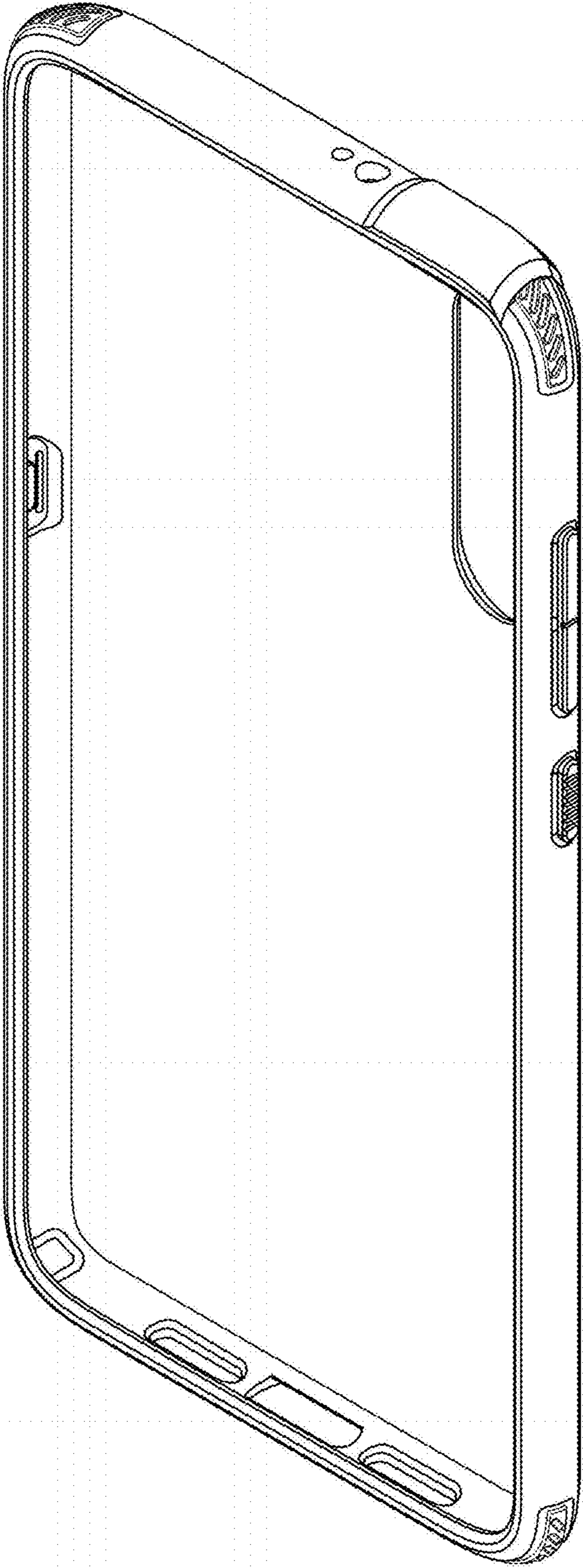

FIG. 2

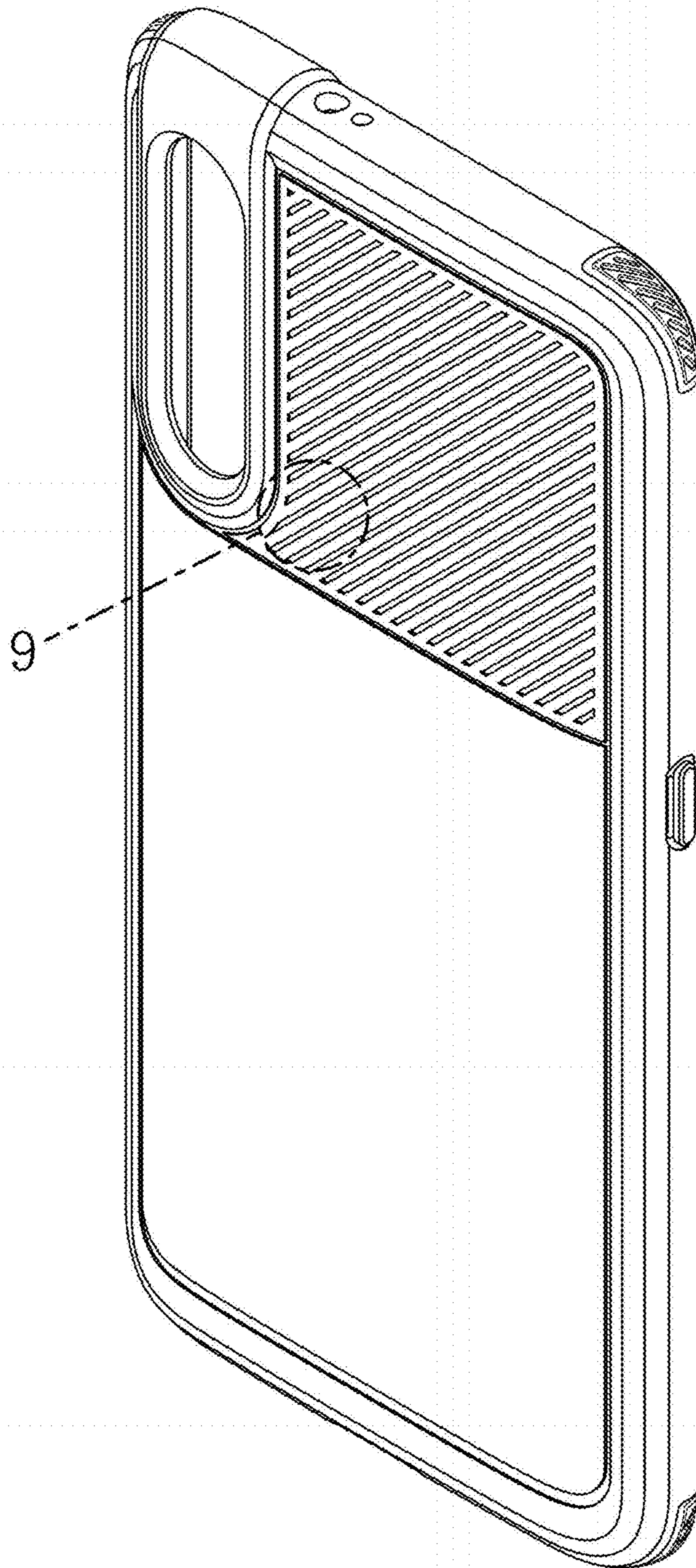

FIG. 3

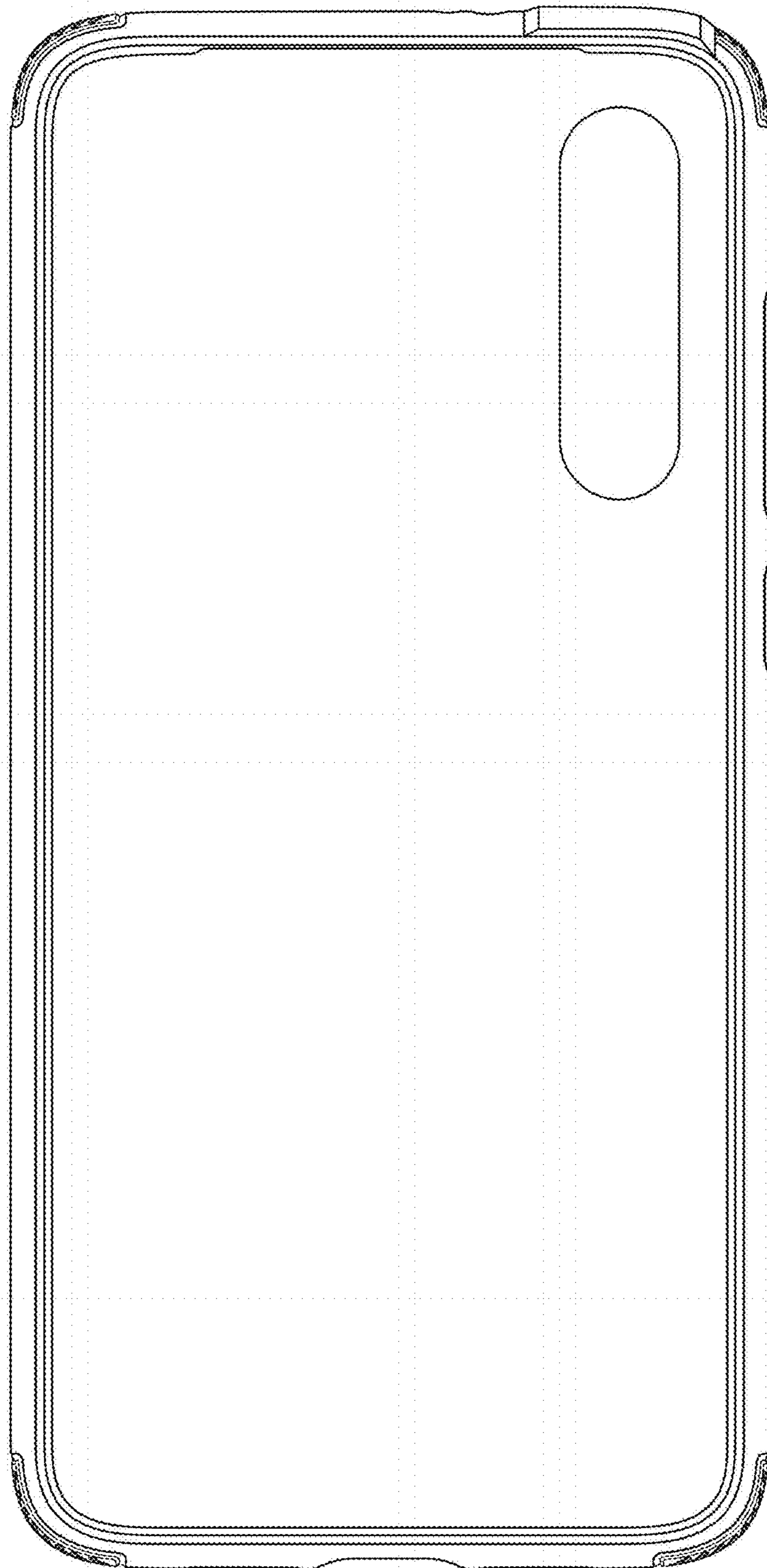



FIG. 4

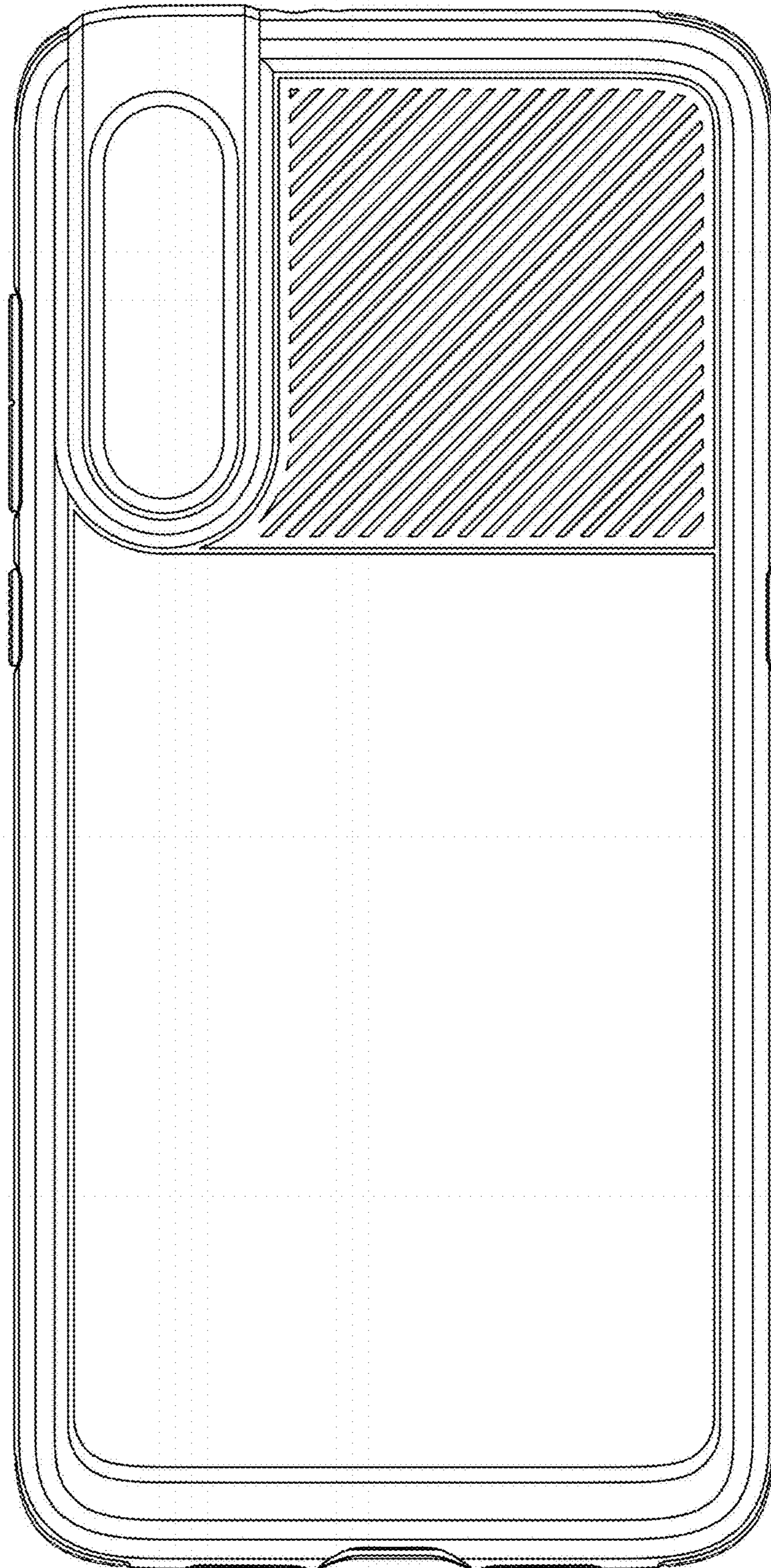

FIG. 5

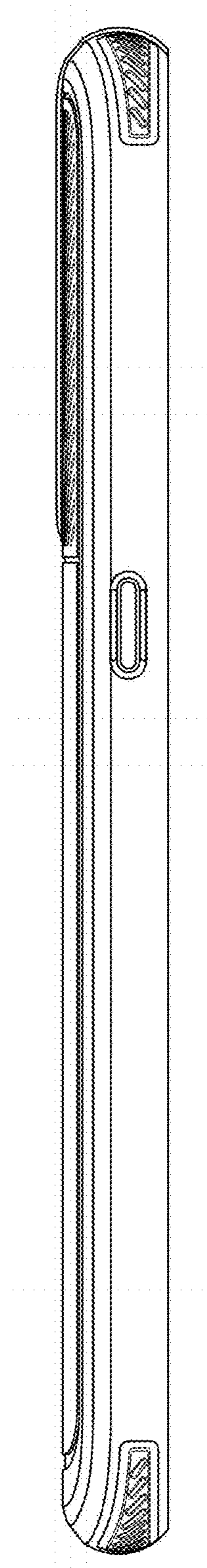



FIG. 6

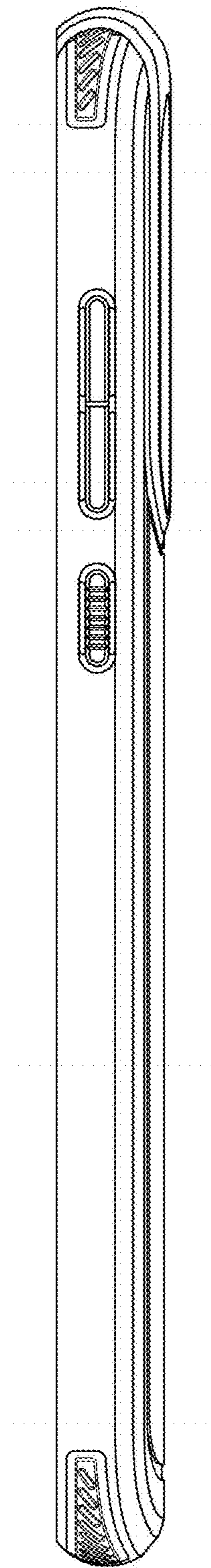

FIG. 7

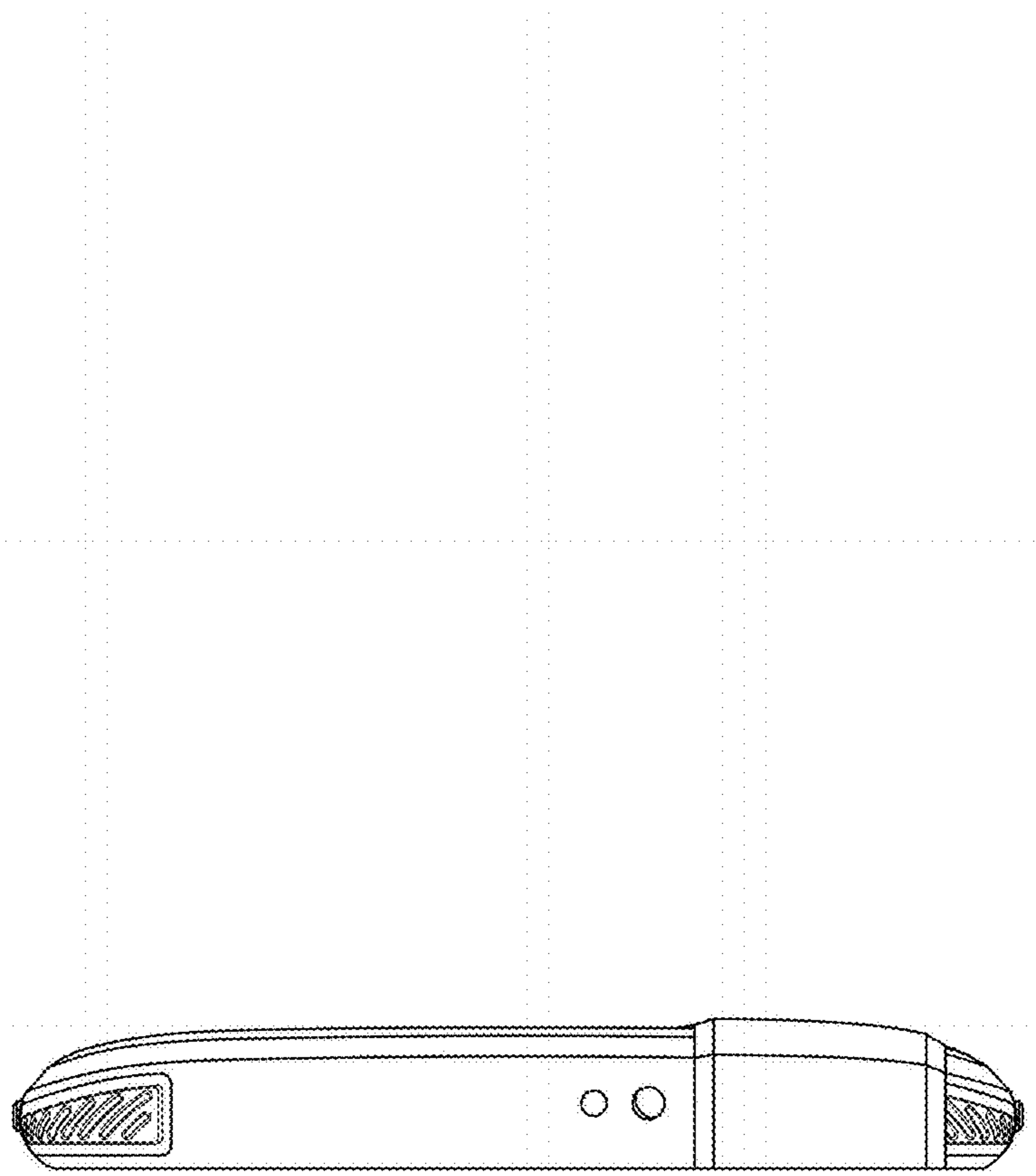



FIG. 8

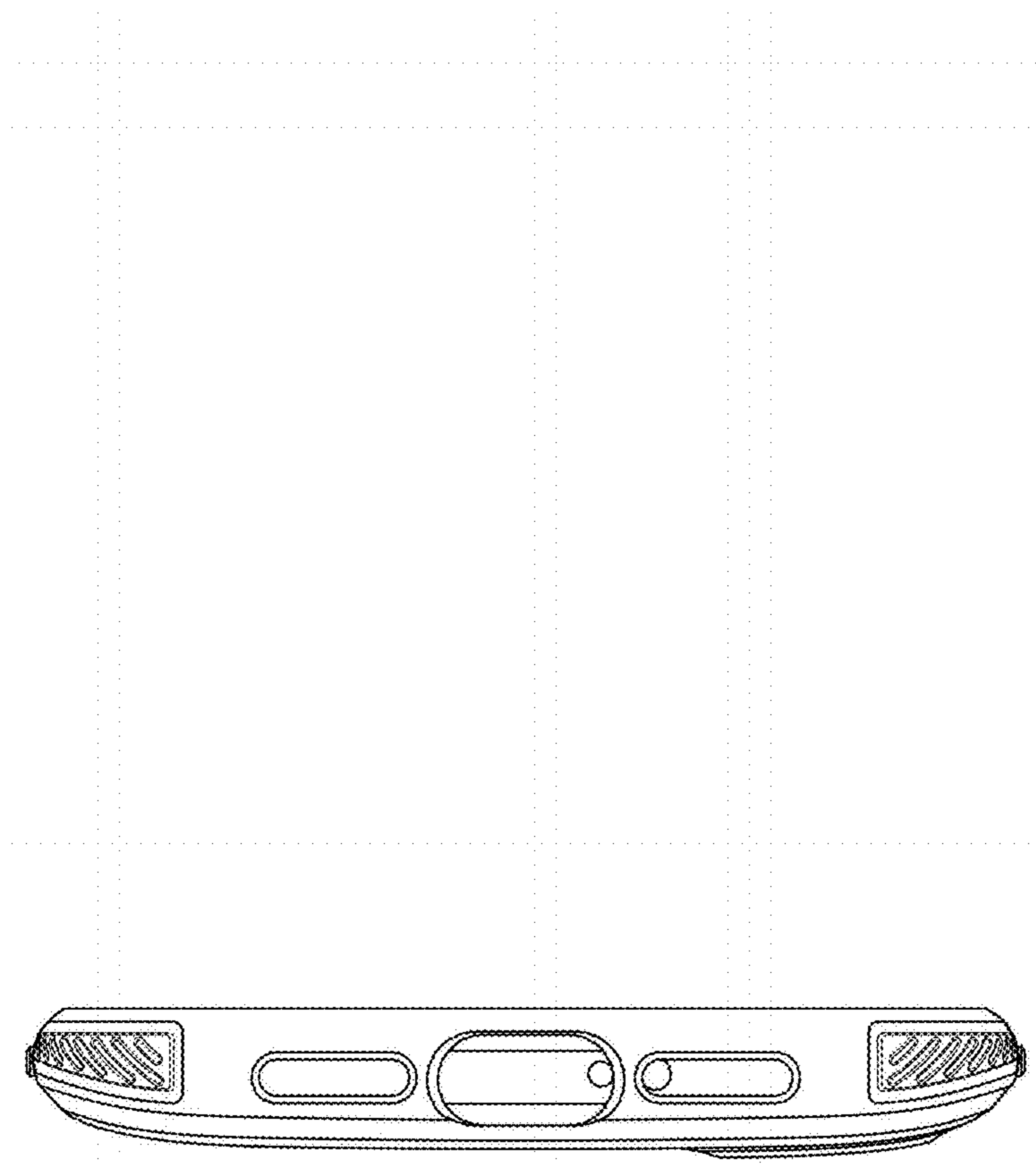

FIG. 9

