



US00D909359S

(12) **United States Design Patent** (10) **Patent No.:** **US D909,359 S**
Kim (45) **Date of Patent:** **** Feb. 2, 2021**

- (54) **CASE FOR ELECTRONIC COMMUNICATIONS DEVICE**
- (71) Applicant: **SPIGEN KOREA CO., LTD.**, Seoul (KR)
- (72) Inventor: **Ki Bum Kim**, Seoul (KR)
- (73) Assignee: **SPIGEN KOREA CO., LTD.**, Seoul (KR)

- D623,180 S 9/2010 Diebel
- D635,757 S 4/2011 Ward, Jr.
- D648,332 S 11/2011 Kim et al.
- D669,062 S 10/2012 Rothbaum
- D669,458 S 10/2012 Wilson et al.
- D670,281 S 11/2012 Corpuz et al.
- D671,930 S 12/2012 Akana et al.
- D676,837 S 2/2013 Rothbaum et al.

(Continued)

- (**) Term: **15 Years**
- (21) Appl. No.: **29/698,019**

(22) Filed: **Jul. 12, 2019**

(51) **LOC (13) Cl.** **14-03**

(52) **U.S. Cl.**
USPC **D14/250**

(58) **Field of Classification Search**
 USPC D14/440, 203.3–203.7, 439, 238.1,
 D14/251–253, 447, 217, 240, 248, 250;
 D3/201, 218, 247, 269, 273, 301, 303;
 D13/103, 119, 107–108
 CPC H04B 1/3888; H04M 1/0283; H04M
 1/0202; A45C 1/06; A45C 11/00; A45C
 13/02; A45C 2011/002; A45F 2005/026;
 A45F 2200/0525; A45F 2200/0516
 See application file for complete search history.

(56) **References Cited**

U.S. PATENT DOCUMENTS

- D484,874 S 1/2004 Chang
- D485,357 S 1/2004 Kapinos, Sr.
- D545,653 S 7/2007 Kirkpatrick
- D574,819 S 8/2008 Andre
- D575,056 S 8/2008 Tan
- D581,151 S 11/2008 Aipa
- D593,750 S * 6/2009 Song D3/269
- D618,230 S 6/2010 Brown
- D622,716 S * 8/2010 Andre D14/250

OTHER PUBLICATIONS

“Spigen Thin Fit Designed for Apple iPhone SE Case (2016)—Black”, <http://www.amazon.com/dp/B01BEDO61U>, Earliest review date of Jun. 20, 2013, Downloaded on Jan. 9, 2019.

(Continued)

Primary Examiner — Clara J Wright

(74) *Attorney, Agent, or Firm* — Heedong Chae; Lucem, PC

(57) **CLAIM**

The ornamental design for a case for electronic communications device, as shown and described.

DESCRIPTION

FIG. 1 is a front perspective view of the case for electronic communications device showing my new design; FIG. 2 is a rear perspective view thereof; FIG. 3 is a front elevational view thereof; FIG. 4 is a rear elevational view thereof; FIG. 5 is a left side elevational view thereof; FIG. 6 is a right side elevational view thereof; FIG. 7 is a top plan view thereof; and, FIG. 8 is a bottom plan view thereof. Except for the solid-line interior portions of the openings and button regions, the interior surface of the case shown in FIGS. 1 and 3 and the broken line shown in FIG. 1 form no part of the claimed design.

1 Claim, 8 Drawing Sheets

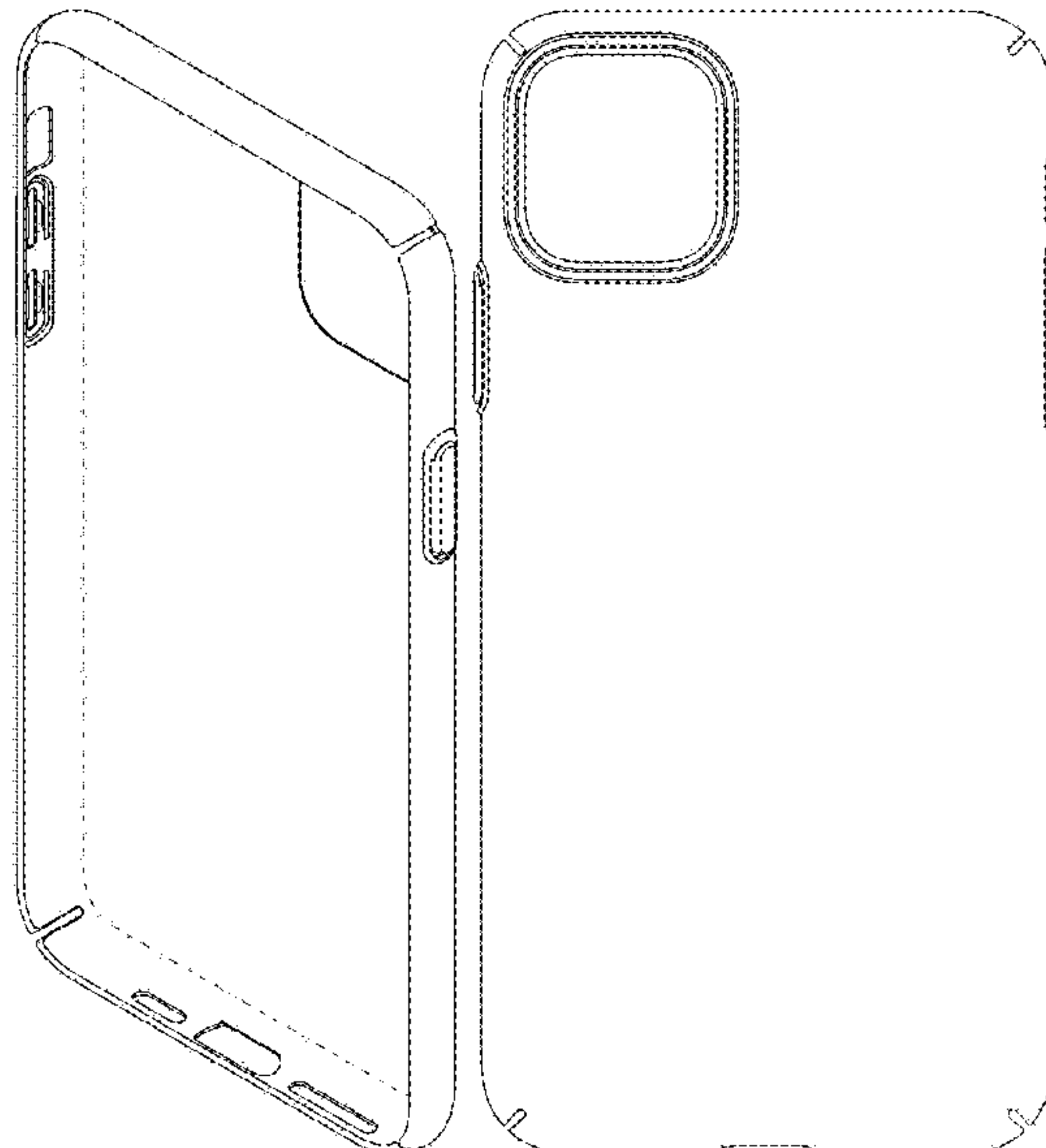

(56)

References Cited

U.S. PATENT DOCUMENTS

D686,606	S	7/2013	Hong	
D686,607	S	7/2013	Hong	
D692,419	S *	10/2013	Rayner	D14/250
D712,892	S	9/2014	Hong et al.	
D714,053	S	9/2014	Yoo	
D714,276	S	9/2014	Hu et al.	
D715,786	S	10/2014	Lee et al.	
D718,291	S	11/2014	Hong	
D719,559	S	12/2014	Dukerschein et al.	
D721,064	S	1/2015	Sun	
D721,072	S	1/2015	Laffon De Mazieres et al.	
D721,360	S	1/2015	Laffon de Mazieres et al.	
D723,531	S	3/2015	Katzke	
D723,535	S	3/2015	Minn et al.	
D726,172	S	4/2015	Watkins et al.	
D735,182	S	7/2015	Watkins et al.	
D739,394	S *	9/2015	Rayner	D14/250
D740,798	S	10/2015	Poon et al.	
D743,389	S	11/2015	Akana et al.	
D746,275	S	12/2015	Mohammad	
D747,708	S	1/2016	Roberts	
D748,614	S	2/2016	Ju	
D754,651	S	4/2016	Roberts et al.	
D757,702	S	5/2016	Kanazawa	
D757,703	S	5/2016	Kanazawa	
D761,774	S	7/2016	Liang	
D761,775	S	7/2016	Pan et al.	
D763,841	S	8/2016	Kim	
D765,634	S	9/2016	McCray et al.	
9,451,066	B1	9/2016	Jia	
D772,210	S	11/2016	Igarashi	
D772,854	S	11/2016	Igarashi	
D774,498	S	12/2016	Tao	
D775,619	S	1/2017	Tien	
D776,100	S	1/2017	Igarashi	
D776,645	S *	1/2017	Del Moral	D14/250
D777,715	S	1/2017	Sawaya	
D779,470	S	2/2017	Kim	
D779,471	S	2/2017	Tien	
D781,839	S	3/2017	Kim et al.	
D800,105	S	10/2017	Roberts	
D800,711	S	10/2017	Kim	
D801,323	S	10/2017	Kim	
D803,823	S	11/2017	Feng	
D807,868	S	1/2018	Wang	
D808,376	S	1/2018	Kim	
D814,453	S *	4/2018	Chiang	D14/250
D822,652	S	7/2018	Kim et al.	
D823,289	S	7/2018	Akana et al.	
D829,201	S	9/2018	Kim et al.	
D834,571	S	11/2018	Ravid	
D836,622	S	12/2018	Kim et al.	
D840,991	S	2/2019	Kim	
D852,183	S *	6/2019	Kim	D14/250
10,362,847	B1 *	7/2019	Okada	A45C 11/00
10,383,416	B2 *	8/2019	Hynecek	A45C 13/005
10,441,044	B2 *	10/2019	Chiang	A45C 11/00
2010/0203931	A1 *	8/2010	Hynecek	A45C 11/00 455/575.8
2014/0221056	A1 *	8/2014	Gandhi	H04B 1/3888 455/575.8
2016/0142522	A1	5/2016	Kim	

OTHER PUBLICATIONS

“Spigen Thin Fit iPhone 6 Case with SF Coated Non Slip Matte Surface for Excellent Grip for iPhone 6S / iPhone 6 Smooth Black”, <http://www.amazon.com/dp/BO0JH87ZSQ>, Earliest review date of Jul. 15, 2014, Downloaded on Nov. 26, 2018.

“Spigen Thin Fit Galaxy SFI Case with Premium Matte Finish Coating for Galaxy S6 2015—Mint”, <http://www.amazon.com/dp/B00QU4N090>, Earliest review date of Feb. 27, 2015, Downloaded on Jan. 9, 2019.

“Spigen Thin Fit Galaxy Note 5 Case with Premium Matte Finish Coating for Galaxy Note 5 2015—Mint”, <http://www.amazon.com/dp/B010MWDTFI>, Earliest review date of Aug. 21, 2015, Downloaded on Jan. 9, 2019.

“iPhone 6s Case, Spigen [Thin Fit] Exact-Fit [Black] Premium Matte Finish Hard Case for iPhone 6s(2015) / iPhone 6 (2014)—Black (SGP11592)”, <http://www.amazon.com/dp/B010MVJDF4>, Earliest review date of Sep. 5, 2015, Downloaded on Jan. 9, 2019.

iPhone 6s Plus Case, Spigen [Thin Fit] Exact-Fit [Black] Premium Matte Finish Hard Case for iPhone 6s Plus (2015) Black (SGP11638), <http://www.amazon.com/dp/B010MVQ06K>, Earliest review date of Sep. 11, 2015, Downloaded on Jan. 9, 2019.

“Spigen Thin Fit iPhone 6S Case with Premium Matte Finish Coating for iPhone 6S 2015—Crystal Clear”, <http://www.amazon.com/dp/B010MVJBMJ>, Earliest review date of Sep. 26, 2015, Downloaded on Jan. 9, 2019.

“Spigen Thin Fit Hybrid iPhone 6S Case with Premium SF Coated Non Slip Matte Surface for Excellent Grip and Dnmp Compatible for iPhone 6S 2015—Black”, <http://www.amazon.com/dp/B013J3C73W>, Earliest review date of Sep. 28, 2015, Downloaded on Jan. 9, 2019.

Spigen, “iPhone 6s Case Thin Fit”, <https://www.spigen.com/collections/other-iphone-series/products/iphone-6s-plus-aase-thin-fit>, Earliest review date of Oct. 20, 2015, Downloaded on Nov. 26, 2018.

“Spigen Thin Fit Hybrid iPhone 6S Plus Case with Premium SF Coated Non Slip Matte Surface for Excellent Grip and Dnmp Compatible for iPhone 6S Plus 2015—Black”, <http://www.amazon.com/dp/B013J3CRGY>, Earliest review date of Oct. 24, 2015, Downloaded on Jan. 9, 2019.

“Spigen Thin Fit Xperia Z5 Case with Premium Matte Finish Coating for Xperia Z5—Gunmetal”, <http://www.amazon.com/dp/B016NF2EWC>, Earliest review date of Nov. 4, 2015, Downloaded on Jan. 9, 2019.

“Nexus 6P Case, Spigen [Thin Fit] Exact-Fit [Black] Premium Matte Finish Hard Case for Nexus 6P (2015)—Black (SGP11814)”, <http://www.amazon.com/dp/B01761J261>, Earliest review date of Nov. 9, 2015, Downloaded on Jan. 9, 2019.

“Spigen Thin Fit Galaxy S7 Edge Case with Premium Matte Finish Coating for Samsung Galaxy S7 Edge 2016 Gunmetal”, <http://www.amazon.com/dp/B01AURONZE>, Earliest review date of Feb. 27, 2016, Downloaded on Mar. 6, 2019.

“Spigen Thin Fit Galaxy S7 Case with SF Coated Non Slip Matte Surface for Excellent Grip for Samsung Galaxy S7 2016—Black”, <http://www.amazon.com/dp/B01A7ICRLO>, Earliest review date of Mar. 3, 2016, Downloaded on Jan. 9, 2019.

“Spigen Thin Fit LG G5 Case with SF Coated Non Slip Matte Surface for Excellent Grip for LG G5 2016—Black”, <http://www.amazon.com/dp/B01B1GQETC>, Earliest review date of Apr. 11, 2016, Downloaded on Jan. 9, 2019.

“Spigen Thin Fit iPhone SE Case with Premium Hard Transparent PC for iPhone SE 2016—Crystal Clear”, <http://www.amazon.com/dp/B01CK2K31Q>, Earliest review date of May 11, 2016, Downloaded on Jan. 9, 2019.

“Spigen Thin Fit iPhone 8 Plus/iPhone 7 Plus Case with SF Coated Non Slip Matte Surface for Excellent Grip and Dnmp Compatible for Apple iPhone 8 Plus (2017) / iPhone 7 Plus (2016)—Black”, <http://www.amazon.com/dp/B0IGIWF4EK>, Earliest review date of Sep. 2, 2016, Downloaded on Jan. 9, 2019.

“Spigen Thin Fit iPhone 8 / iPhone 7 Case with SF Coated Non Slip Matte Surface for Excellent Grip and QNMP compatible for Apple iPhone 8 (2017) / iPhone 7 (2016)—Black”, <http://www.amazon.com/dp/B01GIVW0MG>, Earliest review date of Sep. 15, 2016, Downloaded on Jan. 9, 2019.

Spigen, “iPhone 7 Case Thin Fit”, <https://www.spigen.com/products/iphone-7-case-thin-fit?variant=19841249345>, Earliest review date of Oct. 6, 2016, Downloaded on Nov. 26, 2018.

“Spigen Thin Fit iPhone 8 / iPhone 7 Case with Premium Clear Hard PC and Slim Fit for Apple iPhone 8 (2017) / iPhone 7 (2016)—Crystal Clear”, <http://www.amazon.com/dp/B01LXAZCYG>, Earliest review date of Nov. 22, 2016, Downloaded on Jan. 9, 2019.

(56)

References Cited

OTHER PUBLICATIONS

“Spigen Thin Fit 360 iPhone 7 Plus Case with Exact Slim Full Body Protection Case with 2 Packs of Tempered Glass Screen Protector for iPhone 7 Plus—Black”, <http://www.amazon.com/dp/B01MU4PPJL>, Earliest review date of Jan. 23, 2017, Downloaded on Jan. 9, 2019.

“Spigen Thin Fit 360 iPhone 7 Case with Exact Slim Full Body Protection Case with 2 Packs of Tempered Glass Screen Protector for iPhone 7—Black”, <http://www.amazon.com/dp/B01MT35FRE>, Earliest review date of Jan. 24, 2017, Downloaded on Jan. 9, 2019.

“Spigen Thin Fit LG G6 Case / G6 Plus Case with SF Coated Non Slip Matte Surface for Excellent Grip and QNMP Compatible for LG G6 / G6 Plus (2017)—Black”, <http://www.amazon.com/dp/B01N6T3N9T>, Earliest review date of Mar. 4, 2017, Downloaded on Jan. 9, 2019.

“Spigen Thin Fit Designed for Samsung Galaxy S8 Plus Case (2017)—Black”, <http://www.amazon.com/dp/B06XP4LGHJ>, Earliest review date of Apr. 1, 2017, Downloaded on Jan. 9, 2019.

“Spigen Thin Fit Designed for Samsung Galaxy S8 Case (2017)—Black”, <http://www.amazon.com/dp/B06XP54BCW>, Earliest review date of Apr. 15, 2017, Downloaded on Jan. 9, 2019.

“Spigen Thin Fit Galaxy Note 8 Case with SF Coated Non Slip Matte Surface for Excellent Grip and QNMP Compatible for Galaxy Note 8 (2017)—Matte Black”, <http://www.amazon.com/dp/B073R7DFG1>, Earliest review date of Sep. 5, 2017, Downloaded on Jan. 9, 2019.

“Spigen Thin Fit Designed for Apple iPhone Xs Case (2018) / Designed for Apple iPhone X Case (2017)—Matte Black”, <http://www.amazon.com/dp/B074CM9928>, Earliest review date of Sep. 14, 2017, Downloaded on Jan. 9, 2019.

“Spigen Thin Fit [2nd Generation] iPhone 8 Plus Case/iPhone 7 Plus Case with SF Coated Premium Matte Finish Coating for Apple iPhone 8 Plus (2017) / iPhone 7 Plus (2016)—Black”, <http://www.amazon.com/dp/B07482W96J>, Earliest review date of Oct. 10, 2017, Downloaded on Jan. 9, 2019.

“Spigen Thin Fit [2nd Generation] iPhone 8 Case with SF Coated Non Slip Matte Surface for Excellent Grip and Nireless Charging Compatible for Apple iPhone 8 (2017)—Black”, <https://www.amazon.com/Spigen-Generation-Excellent-Wireless-Compatible/dp/B074835C74>, Earliest review date of Oct. 18, 2017, Downloaded on Jan. 9, 2019.

“Spigen Thin Fit Google Pixel 2 XL Case with SF Coated Non Slip Matte Surface for Excellent Grip for Google Pixel 2 XL (2017)—Black”, <http://www.amazon.com/dp/B07475C1VT>, Earliest review date of Oct. 19, 2017, Downloaded on Jan. 9, 2019.

“Spigen Thin Fit Google Pixel 2 Case with SF Coated Non Slip Matte Surface for Excellent Grip for Google Pixel 2 (2017)—Black”, <http://www.amazon.com/dp/B07477L9JD>, Earliest review date of Oct. 22, 2017, Downloaded on Jan. 9, 2019.

“Spigen Thin Fit iPhone 8 / iPhone 7 Case with Premium Matte Finish Coating and QNMP Compatible for Apple iPhone 8 (2017) / iPhone 7 (2016)—Red”, <https://www.amazon.com/Spigen-iPhone-Premium-Coating-Compatible/dp/B0753G3DGN>, Earliest review date of Dec. 20, 2017, Downloaded on Jan. 9, 2019.

“Spigen Thin Fit Designed for iPad Pro 12.9 Case (2017)—Black”, <http://www.amazon.com/dp/B075FH7TV2>, Earliest review date of Dec. 25, 2017, Downloaded on Jan. 9, 2019.

“Spigen Thin Fit 360 Galaxy Note 8 Case with Exact Slim Full Protection and Tempered Glass Galaxy Note 8 Screen Protector (2017)—Orchid Gray”, <http://www.amazon.com/dp/B073RWK9R6>, Earliest review date of Dec. 28, 2017, Downloaded on Jan. 9, 2019.

“Spigen Thin Fit 360 Designed for Apple iPhone Xs Case (2018) / Designed for Apple iPhone X Case (2017)—Black”, <http://www.amazon.com/dp/B074Z7J4PC>, Earliest review date of Jan. 4, 2018, Downloaded on Jan. 9, 2019.

“Spigen Thin Fit Galaxy S9 Plus Case with SF Coated Non Slip Matte Surface for Excellent Grip and QNMP Compatible for Galaxy S9 Plus (2018)—Black”, <http://www.amazon.com/dp/B0789QYCMS>, Earliest review date of Mar. 6, 2018, Downloaded on Jan. 9, 2019.

“Spigen Thin Fit Galaxy S9 Case with SF Coated Non Slip Matte Surface for Excellent Grip and QNMP Compatible for Galaxy S9 (2018)—Black”, <https://www.amazon.com/Spigen-Galaxy-Surface-Excellent-Compatible/dp/B078BBJKK9>, Earliest review date of Mar. 9, 2018, Downloaded on Jan. 9, 2019.

“Spigen Thin Fit 360 Galaxy S9 Case with Exact Slim Full Protection with Tempered Glass Screen Protector for Samsung Galaxy S9 (2018)—Black”, <http://www.amazon.com/dp/B07896GDZ7>, Earliest review date of Mar. 15, 2018, Downloaded on Jan. 9, 2019.

“Spigen Thin Fit 360 Galaxy S9 Plus Case with Exact Slim Full Protection with Tempered Glass Screen Protector for Samsung Galaxy S9 Plus (2018)—Black”, <http://www.amazon.com/dp/B07898KVKH>, Earliest review date of Apr. 6, 2018, Downloaded on Jan. 9, 2019.

* cited by examiner

FIG. 1

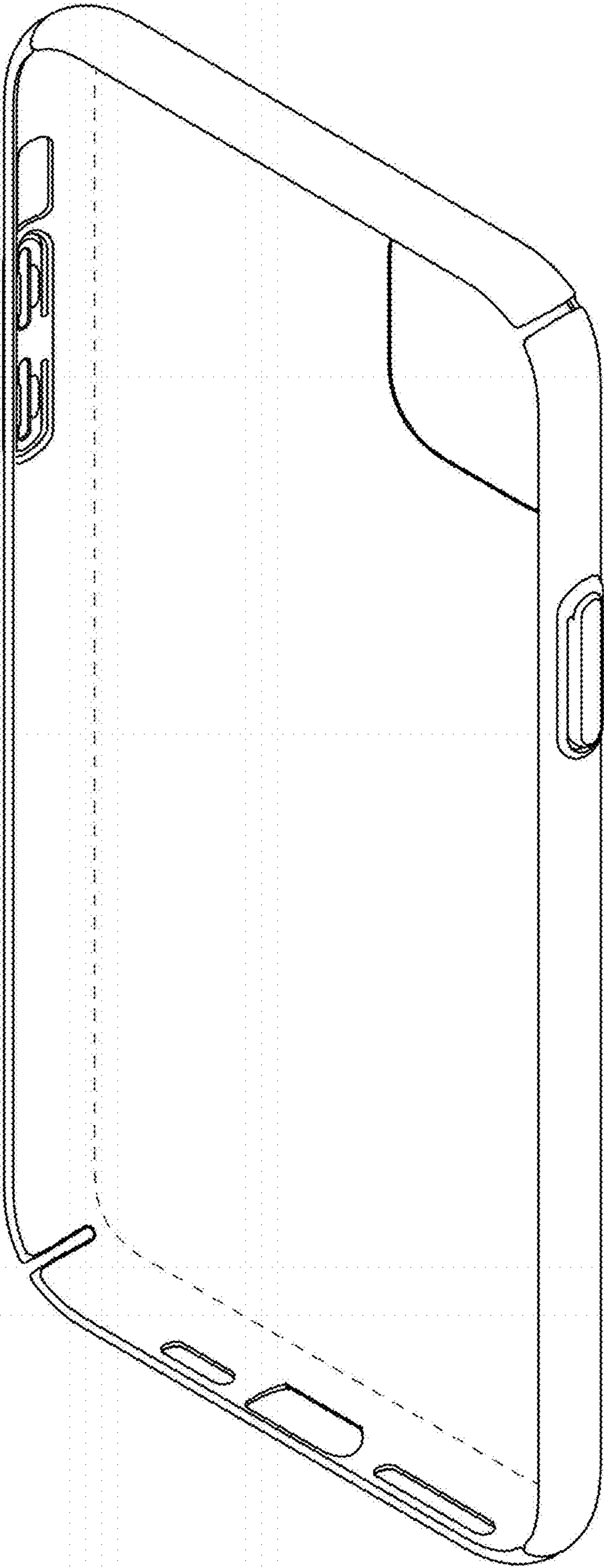

FIG. 2

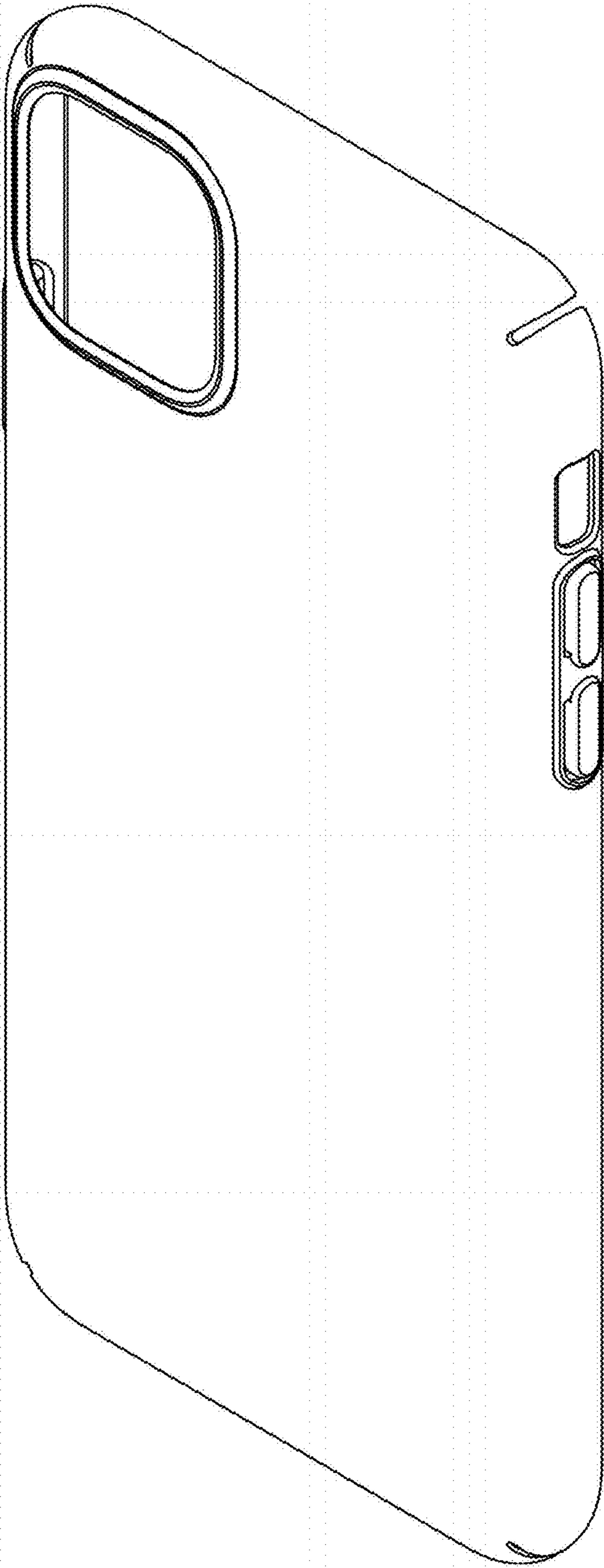

FIG. 3

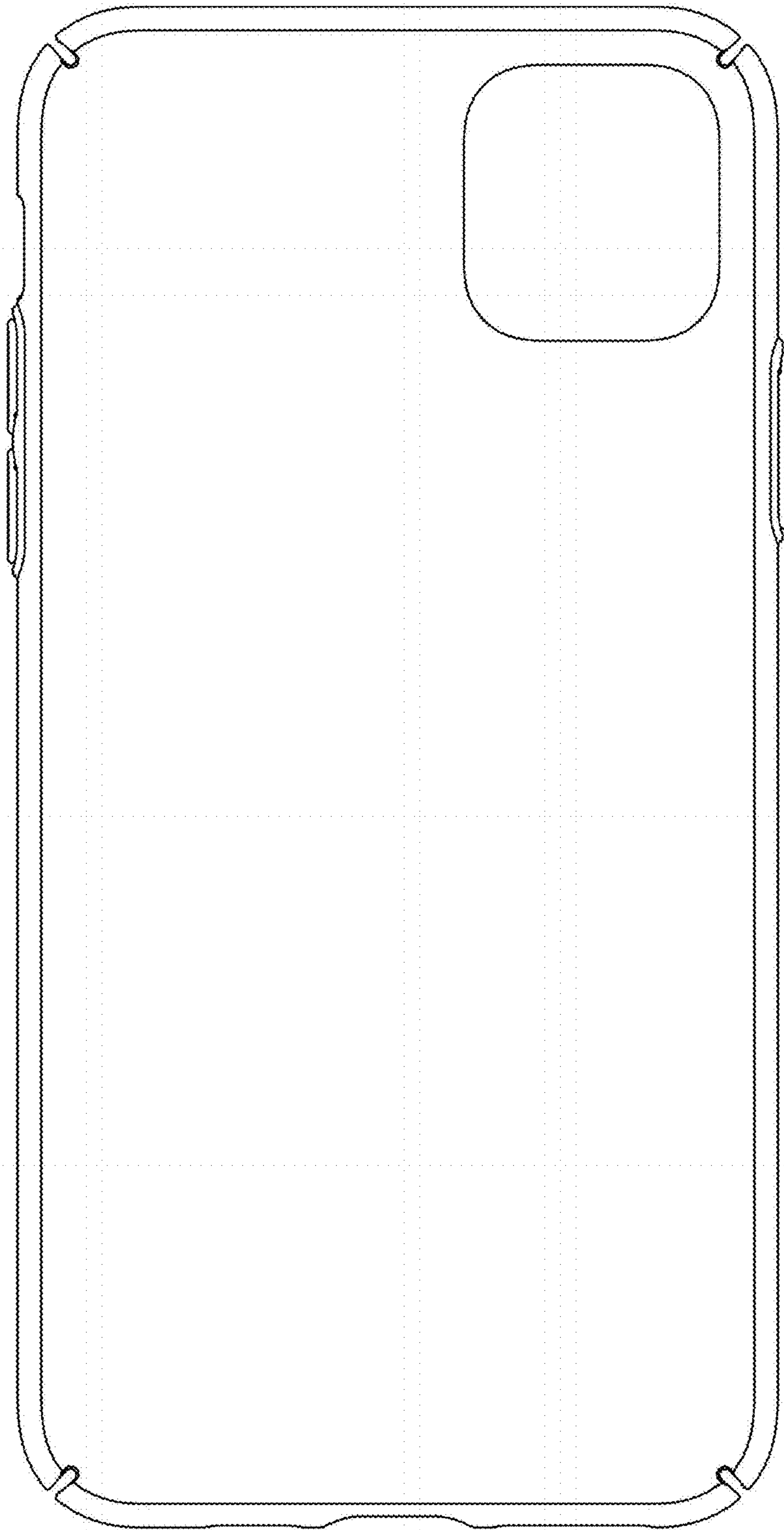

FIG. 4

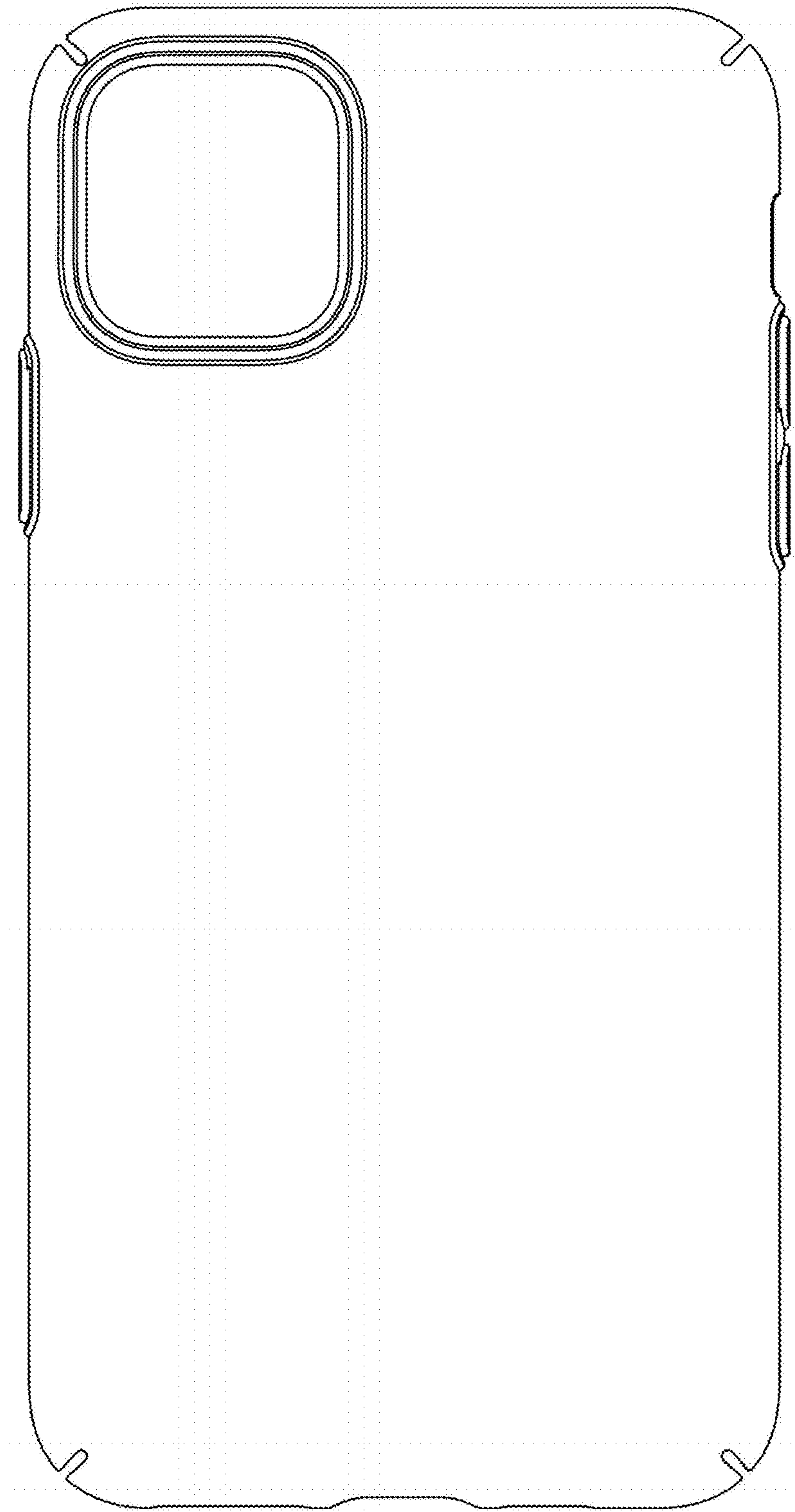

FIG. 5

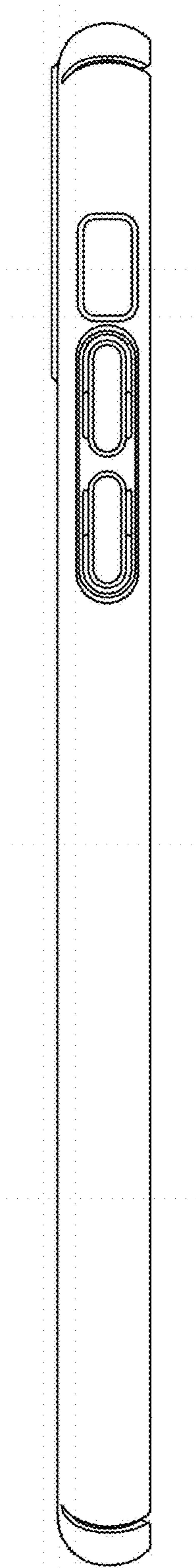

FIG. 6

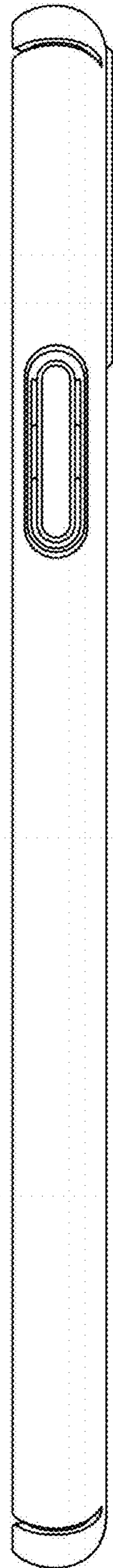

FIG. 7

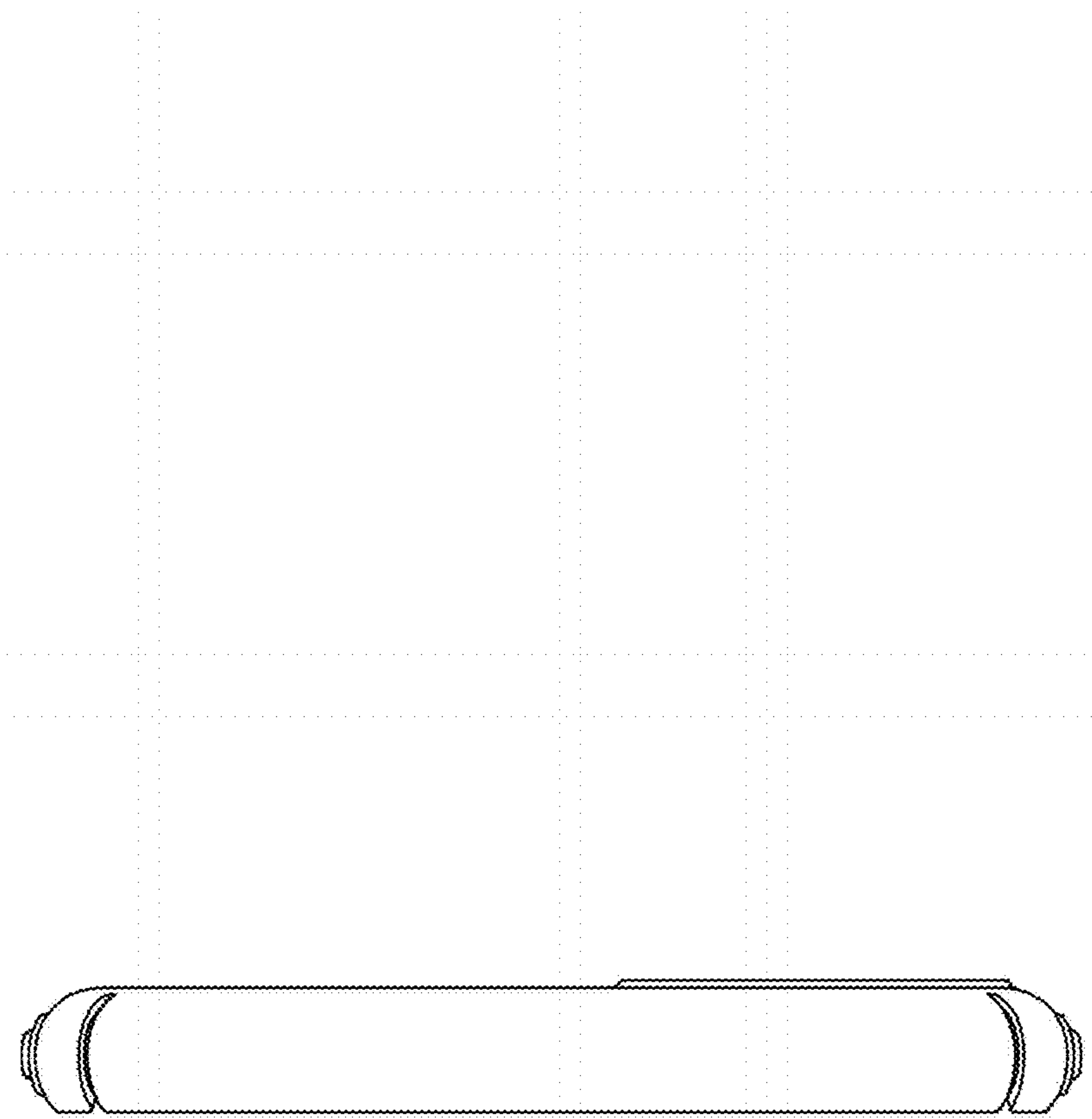

FIG. 8

