



US00D909074S

(12) **United States Design Patent**
Katz et al.

(10) **Patent No.:** **US D909,074 S**

(45) **Date of Patent:** **** *Feb. 2, 2021**

(54) **PICTURE FRAME**

(71) Applicant: **Mixtiles Ltd.**, Tel Aviv (IL)

(72) Inventors: **David Katz**, Tel Aviv (IL); **Nir Beit Av**, Mevo Hama (IL)

(73) Assignee: **MIXTILES LTD.**, Tel Aviv (IL)

(*) Notice: This patent is subject to a terminal disclaimer.

(**) Term: **15 Years**

(21) Appl. No.: **29/637,793**

(22) Filed: **Feb. 22, 2018**

(51) **LOC (13) Cl.** **06-07**

(52) **U.S. Cl.**
USPC **D6/300**

(58) **Field of Classification Search**
USPC D6/300-314
CPC A47G 1/06; A47G 1/065; A47G 1/0605;
A47G 1/00; A47G 1/12; A47G 1/17;
A47G 2001/0666; A47G 2001/0672;
A47G 2001/0677; A47G 2001/0661;
A47G 1/1606; G03B 21/64; G09F 15/00;
G09F 15/0006; G09F 15/0012; F16B
47/00; F16B 47/003

See application file for complete search history.

(56) **References Cited**

U.S. PATENT DOCUMENTS

- 2,268,529 A * 12/1941 Stiles G03B 21/64
40/702
- 3,400,477 A * 9/1968 Brown G03B 21/64
40/661.09
- D230,238 S * 2/1974 Coda D6/300
- 4,605,292 A * 8/1986 McIntosh A47G 1/00
248/205.3
- D290,787 S * 7/1987 Chisholm D10/2
- D332,702 S * 1/1993 Kaga D6/310

- D368,128 S * 3/1996 McCarthy D23/213
- D400,842 S * 11/1998 Davis D12/216
- D422,575 S * 4/2000 Tikhonski D14/126
- 6,212,683 B1 * 4/2001 Liebmann A41B 13/10
2/48
- D463,308 S * 9/2002 Skiles D11/3
- D481,544 S * 11/2003 Di Leggerini D6/300
- D487,272 S * 3/2004 Korpai D14/448

(Continued)

FOREIGN PATENT DOCUMENTS

- CA 182263 S 5/2019
- CA 183024 S 5/2019

(Continued)

OTHER PUBLICATIONS

“How to Hang Picture Frames Without Nails” via Mommy Blogger Sigrid, available Oct. 10, 2014, [online], [site visited Jul. 31, 2020]. Available from internet, URL: <https://www.lovinglymama.com/mounting-picture-frames-on-a-photo-wall-using-3m-double-sided-bonding-tape/> (Year: 2014).*

(Continued)

Primary Examiner — W. A. Teddy Falloway
(74) *Attorney, Agent, or Firm* — The Roy Gross Law Firm, LLC; Roy Gross

(57) **CLAIM**

The ornamental design for a picture frame, as shown and described.

DESCRIPTION

FIG. 1 is a front, top, right perspective view of a picture frame showing our design;
FIG. 2 is a back, top, left perspective view thereof;
FIG. 3 is a left side view thereof;
FIG. 4 is a right side view thereof;
FIG. 5 is a top view thereof; and,
FIG. 6 is a bottom view thereof.

1 Claim, 3 Drawing Sheets

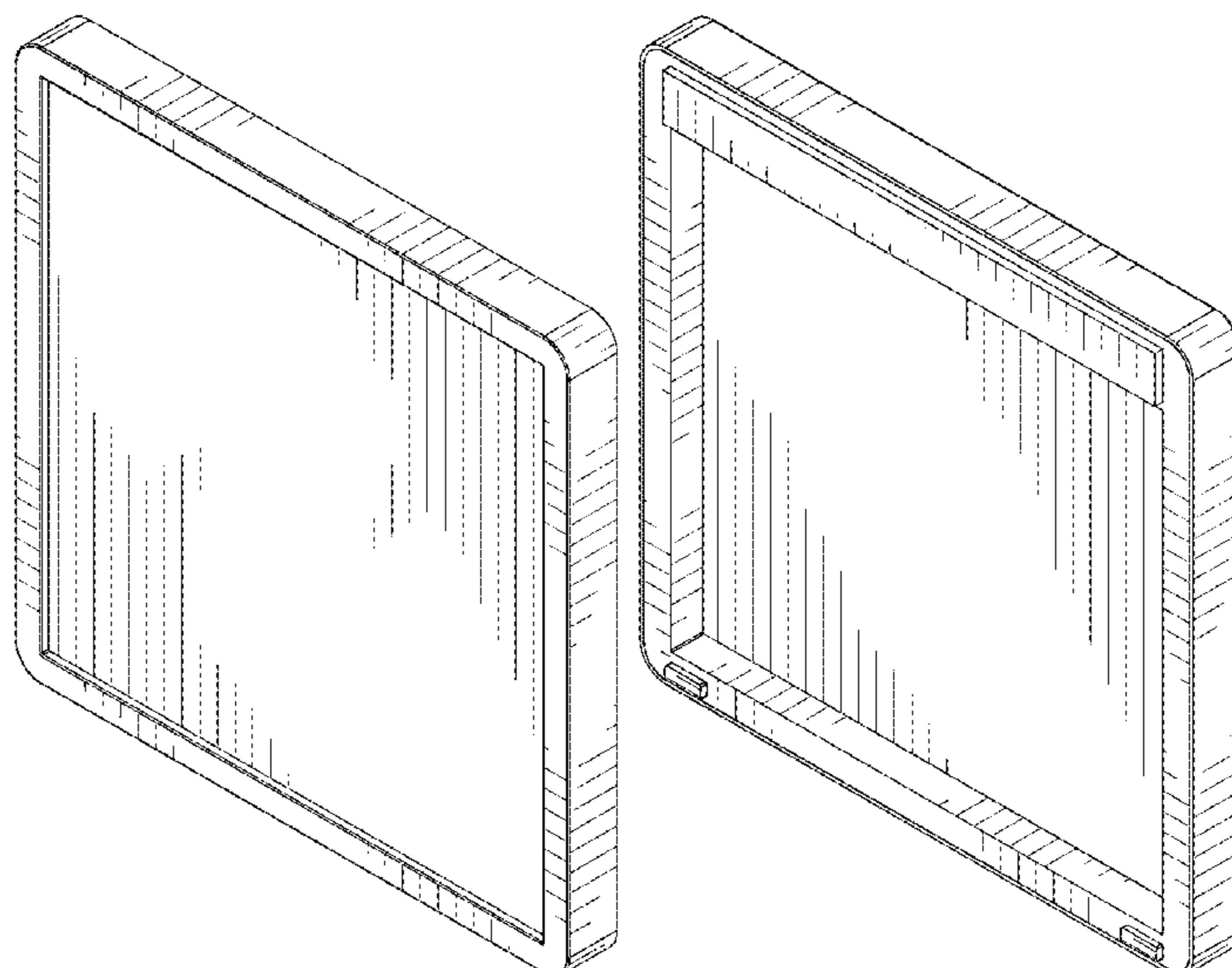

(56)

References Cited

U.S. PATENT DOCUMENTS

| | | | | | | |
|--------------|----|---|---------|--------------|-------|-------------------------|
| D487,465 | S | * | 3/2004 | Korpai | | D14/448 |
| D488,161 | S | * | 4/2004 | Korpai | | D14/448 |
| D488,162 | S | * | 4/2004 | Korpai | | D14/448 |
| D492,079 | S | * | 6/2004 | Feltman | | D99/5 |
| 7,028,507 | B2 | * | 4/2006 | Rapport | | A44C 5/003 63/18 |
| D523,249 | S | * | 6/2006 | Hoernig | | D6/300 |
| D532,247 | S | * | 11/2006 | Copeland | | D7/354 |
| D559,556 | S | * | 1/2008 | Puig | | D6/300 |
| D591,957 | S | * | 5/2009 | Lee | | D6/300 |
| D662,750 | S | * | 7/2012 | Leask | | D6/603 |
| D739,149 | S | * | 9/2015 | Shay-Puetzer | | D6/300 |
| D747,109 | S | * | 1/2016 | Shay-Puetzer | | D6/300 |
| D751,831 | S | * | 3/2016 | Shay-Puetzer | | D6/314 |
| D781,743 | S | * | 3/2017 | McDonald | | D11/164 |
| D808,178 | S | * | 1/2018 | Jones | | D6/300 |
| D835,333 | S | * | 12/2018 | Silver | | D26/113 |
| D851,172 | S | * | 6/2019 | Vaiden, II | | D19/113 |
| 10,368,663 | B2 | * | 8/2019 | Pinoli | | D05B 97/12 |
| D876,251 | S | * | 2/2020 | Branham | | D10/64 |
| D881,510 | S | * | 4/2020 | Pandolfino | | D2/605 |
| 2001/0045039 | A1 | * | 11/2001 | Lee | | A47G 1/0622 40/714 |
| 2002/0020485 | A1 | * | 2/2002 | Weder | | B29C 66/4322 156/214 |

| | | | | | | |
|--------------|----|---|---------|--------------|-------|----------------------|
| 2005/0193614 | A1 | * | 9/2005 | Conrad | | A47G 1/065 40/757 |
| 2009/0049727 | A1 | * | 2/2009 | Vincent | | A47G 1/065 40/730 |
| 2009/0071052 | A1 | * | 3/2009 | Craig | | A47G 1/065 40/791 |
| 2015/0272350 | A1 | * | 10/2015 | Frankenstein | | A47G 1/06 40/711 |
| 2017/0135504 | A1 | * | 5/2017 | Jones | | A47G 1/1666 |
| 2017/0146322 | A1 | * | 5/2017 | Seuk | | F41J 1/10 |
| 2019/0183244 | A1 | * | 6/2019 | Cohen | | A47B 83/04 |

FOREIGN PATENT DOCUMENTS

| | | | |
|----|----------------|---|--------|
| CA | 183415 | S | 5/2019 |
| CA | 183416 | S | 5/2019 |
| EP | 005617545-0002 | S | 8/2018 |
| EP | 005633153-0001 | S | 8/2018 |
| EP | 005633153-0002 | S | 8/2018 |

OTHER PUBLICATIONS

Flikframe: World's 1st re-stickable, collapsible photo frame (via Kickstarter), available Nov. 14, 2017, [online], [site visited Jul. 31, 2020]. Available from internet, URL: <https://www.kickstarter.com/projects/flikframe/flikframe-picture-frames-that-dont-mess-up-your-wa> (Year: 2017).*

* cited by examiner

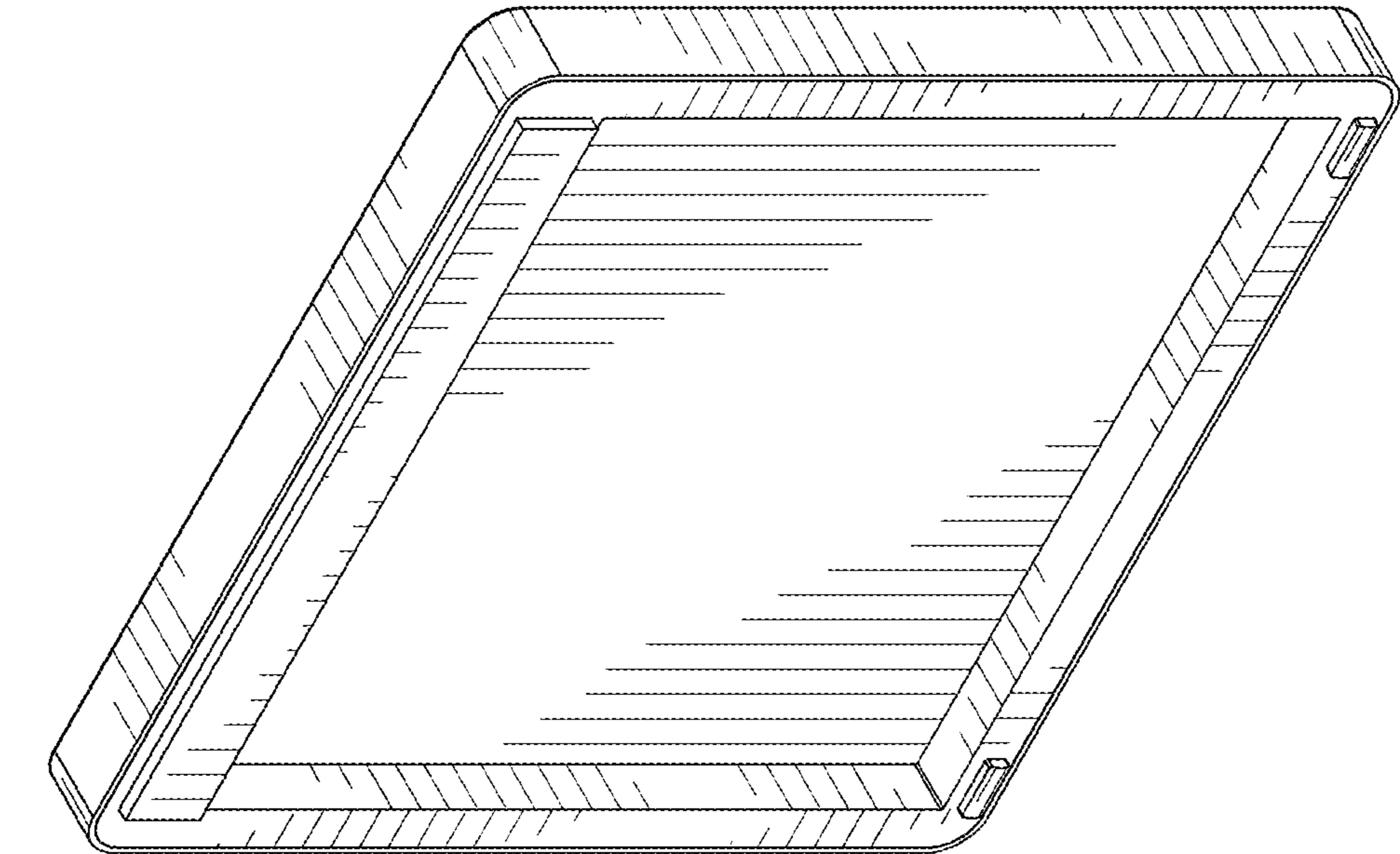

FIG. 1

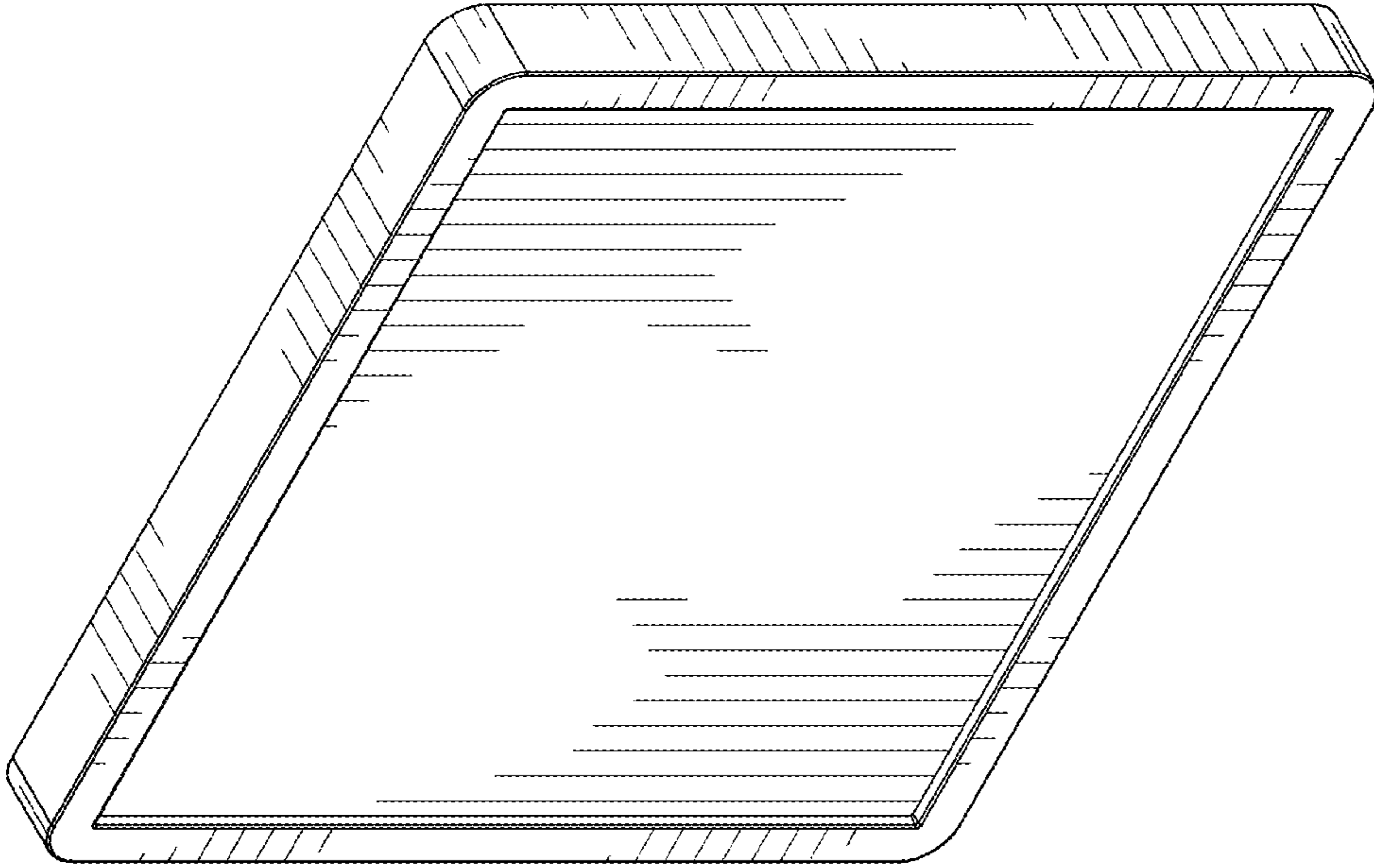

FIG. 2

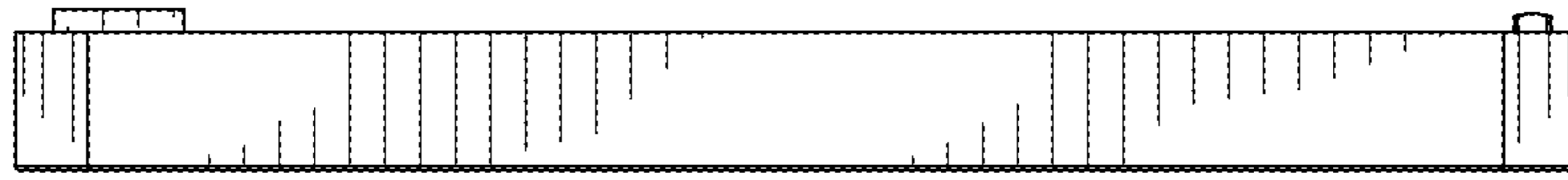

FIG. 4

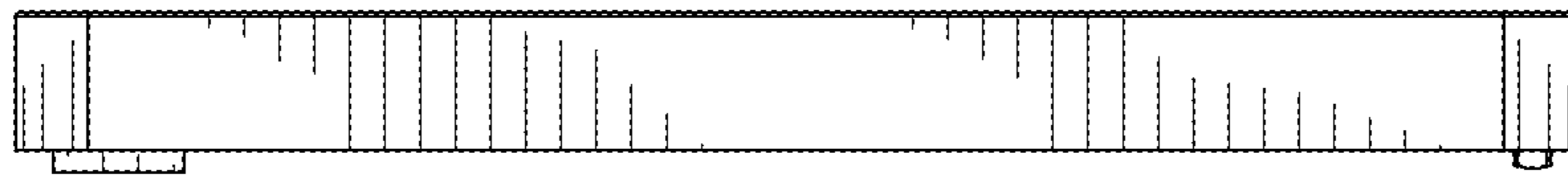

FIG. 3

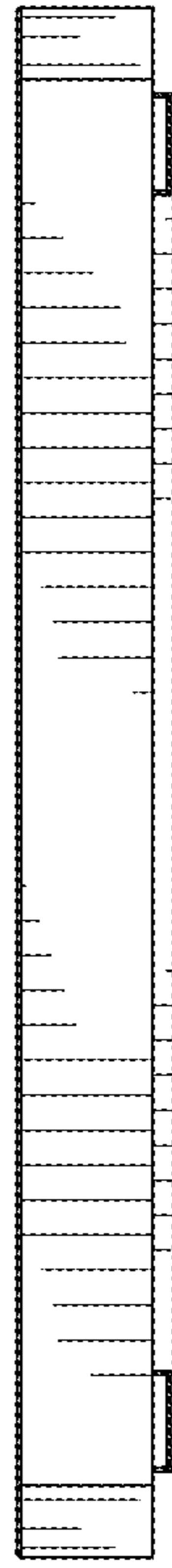

FIG. 5



FIG. 6