



US00D909073S

(12) **United States Design Patent**  
**Katz et al.**

(10) **Patent No.:** **US D909,073 S**  
(45) **Date of Patent:** **\*\* Feb. 2, 2021**

(54) **PICTURE FRAME**  
(71) Applicant: **Mixtiles Ltd.**, Tel Aviv (IL)  
(72) Inventors: **David Katz**, Tel Aviv (IL); **Nir Beit Av**, Mevo Hama (IL)

D481,544 S \* 11/2003 Di Leggerini ..... D6/300  
D492,079 S \* 6/2004 Feltman ..... D99/5  
D523,249 S \* 6/2006 Hoernig ..... D6/300  
D532,247 S \* 11/2006 Copeland ..... D7/354

(Continued)

(73) Assignee: **MIXTILES LTD.**, Tel Aviv (IL)  
(\*\*) Term: **15 Years**

FOREIGN PATENT DOCUMENTS

CA 182263 \* 5/2019  
CA 183024 \* 5/2019

(Continued)

(21) Appl. No.: **29/631,827**

OTHER PUBLICATIONS

(22) Filed: **Jan. 3, 2018**  
(51) **LOC (13) Cl.** ..... **06-07**  
(52) **U.S. Cl.**  
USPC ..... **D6/300**

“How to Hang Picture Frames Without Nails” via Mommy Blogger Sigrid, available Oct. 10, 2014, [online], [site visited Jul. 31, 2020]. Available from internet, URL: <https://www.lovinglymama.com/mounting-picture-frames-on-a-photo-wall-using-3m-double-sided-bonding-tape/> (Year: 2014).\*

(Continued)

(58) **Field of Classification Search**  
USPC ..... D6/300–314  
CPC ..... A47G 1/06; A47G 1/065; A47G 1/0605;  
A47G 1/00; A47G 1/12; A47G 1/17;  
A47G 2001/0666; A47G 2001/0672;  
A47G 2001/0677; A47G 2001/0661;  
A47G 1/1606; G03B 21/64; G09F 15/00;  
G09F 15/0006; G09F 15/0012; F16B  
14/00; F16B 47/003

*Primary Examiner* — W. A. Teddy Falloway  
(74) *Attorney, Agent, or Firm* — The Roy Gross Law Firm, LLC; Roy Gross

See application file for complete search history.

(57) **CLAIM**

The ornamental design for a picture frame, as shown and described.

(56) **References Cited**

U.S. PATENT DOCUMENTS

2,268,529 A \* 12/1941 Stiles ..... G03B 21/64  
40/702  
3,400,477 A \* 9/1968 Brown ..... G03B 21/64  
40/661.09  
D230,238 S \* 2/1974 Coda ..... D6/300  
4,605,292 A \* 8/1986 McIntosh ..... A47G 1/00  
248/205.3  
D290,787 S \* 7/1987 Chisholm ..... D10/2  
D332,702 S \* 1/1993 Kaga ..... D6/310  
D400,842 S \* 11/1998 Davis ..... D12/216  
D422,575 S \* 4/2000 Tikhonski ..... D14/126  
6,212,683 B1 \* 4/2001 Liebmann ..... A41B 13/10  
2/48

**DESCRIPTION**

FIG. 1 is a front, top, right perspective view of a picture frame showing our design;  
FIG. 2 is a back, top, left perspective view thereof;  
FIG. 3 is a front view thereof;  
FIG. 4 is a rear view thereof;  
FIG. 5 is a left side view thereof;  
FIG. 6 is a right side view thereof;  
FIG. 7 is a top view thereof; and,  
FIG. 8 is a bottom view thereof.

**1 Claim, 4 Drawing Sheets**

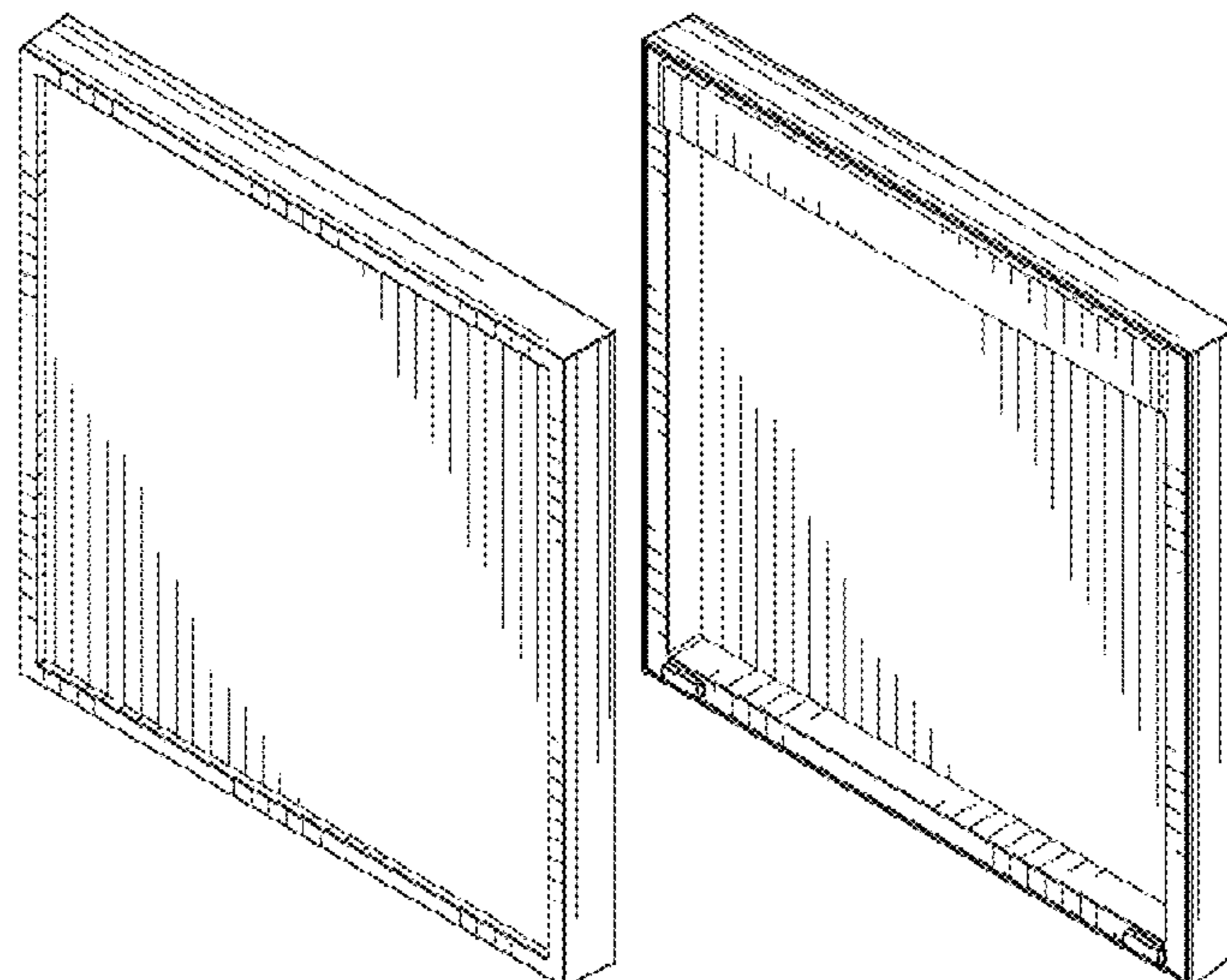

(56)

References Cited

U.S. PATENT DOCUMENTS

D559,556 S \* 1/2008 Puig ..... D6/300  
 D591,957 S \* 5/2009 Lee ..... D6/300  
 D662,750 S \* 7/2012 Leask ..... D6/603  
 D739,149 S \* 9/2015 Shay-Puetzer ..... D6/300  
 D747,109 S \* 1/2016 Shay-Puetzer ..... D6/300  
 D751,831 S \* 3/2016 Shay-Puetzer ..... D6/314  
 D781,743 S \* 3/2017 McDonald ..... D11/164  
 D808,178 S \* 1/2018 Jones ..... D6/300  
 D835,333 S \* 12/2018 Silver ..... D26/113  
 D851,172 S \* 6/2019 Vaiden, II ..... D19/113  
 10,368,663 B2 \* 8/2019 Pinoli ..... D05B 97/12  
 D876,251 S \* 2/2020 Branham ..... D10/64  
 2001/0045039 A1 \* 11/2001 Lee ..... A47G 1/0622  
 40/714  
 2002/0020485 A1 \* 2/2002 Weder ..... B29C 66/4322  
 156/214  
 2005/0193614 A1 \* 9/2005 Conrad ..... A47G 1/065  
 40/757  
 2009/0049727 A1 \* 2/2009 Vincent ..... A47G 1/065  
 40/730  
 2009/0071052 A1 \* 3/2009 Craig ..... A47G 1/065  
 40/791

2015/0272350 A1 \* 10/2015 Frankenstein ..... A47G 1/06  
 40/711  
 2017/0135504 A1 \* 5/2017 Jones ..... A47G 1/1666  
 2017/0146322 A1 \* 5/2017 Seuk ..... F41J 1/10  
 2019/0183244 A1 \* 6/2019 Cohen ..... A47B 83/04

FOREIGN PATENT DOCUMENTS

CA 183415 S 5/2019  
 CA 183416 S 5/2019  
 EP 005617545-0002 \* 8/2018  
 EP 005633153-0001 S 12/2018  
 EP 005633153-0002 S 12/2018

OTHER PUBLICATIONS

Flikframe: World's 1st re-stickable, collapsible photo frame (via Kickstarter), available Nov. 14, 2017, [online], [site visited Jul. 31, 2020]. Available from internet, URL: <https://www.kickstarter.com/projects/flikframe/flikframe-picture-frames-that-dont-mess-up-your-wa> (Year: 2017).\*

\* cited by examiner

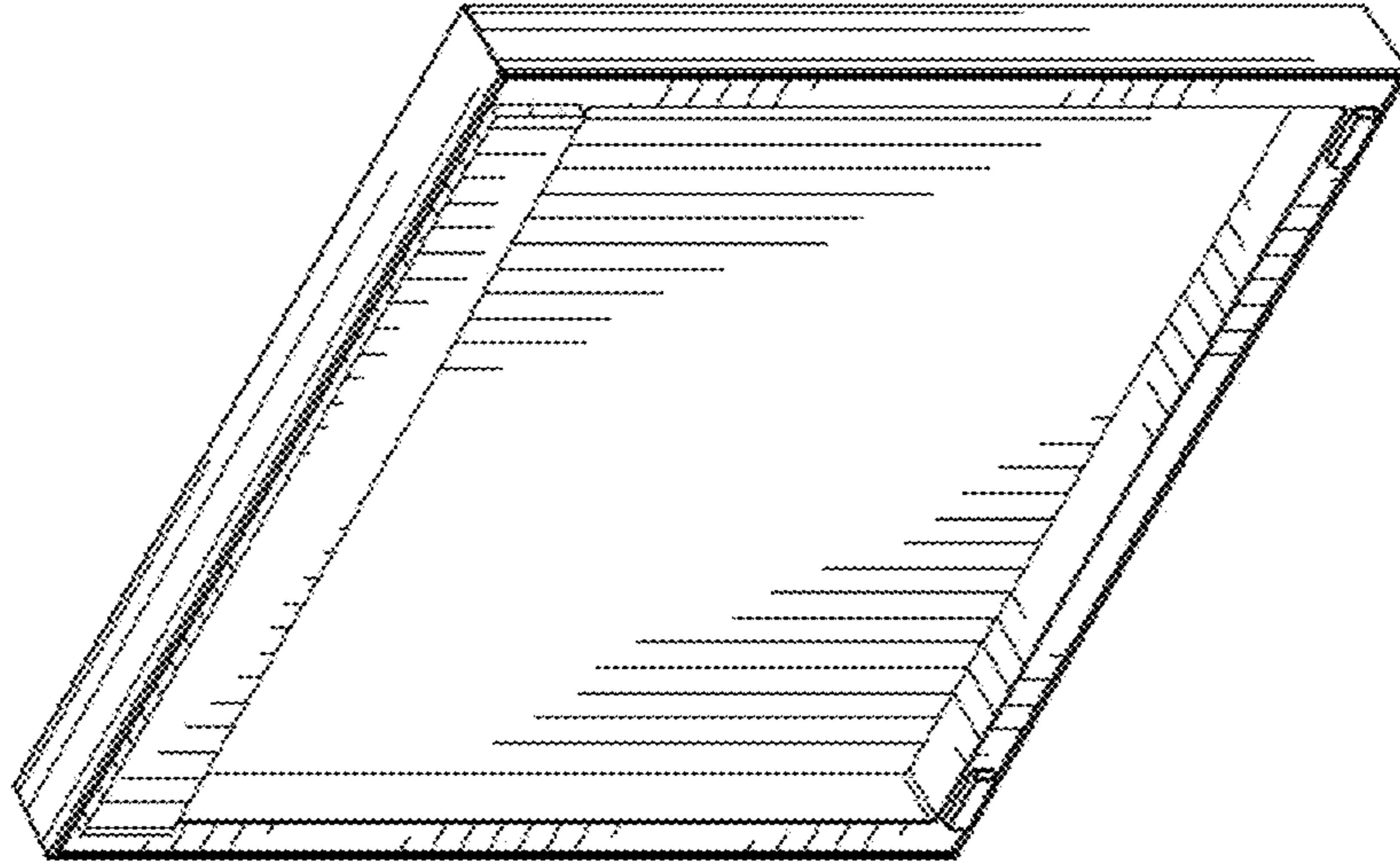

FIG. 1

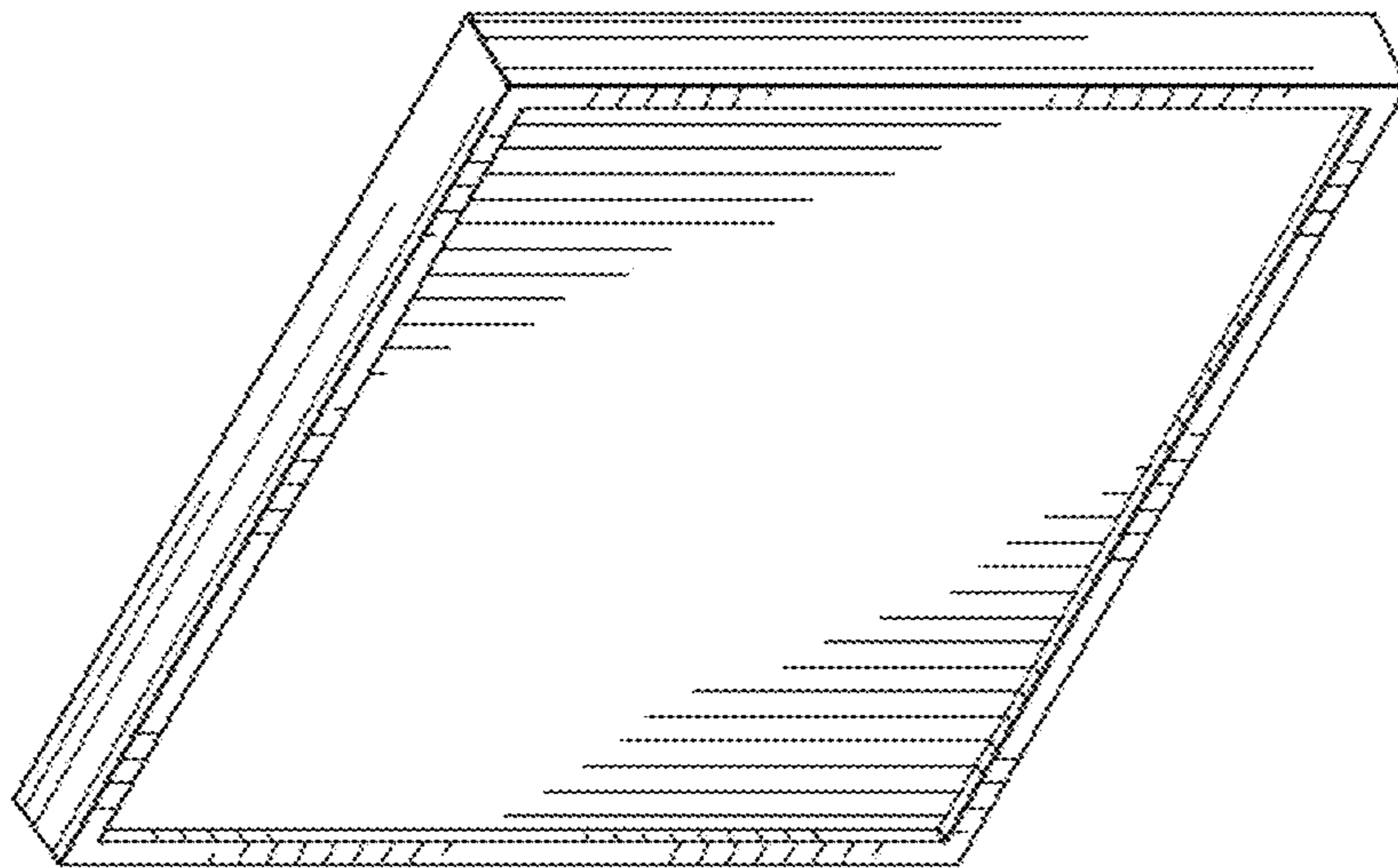

FIG. 2

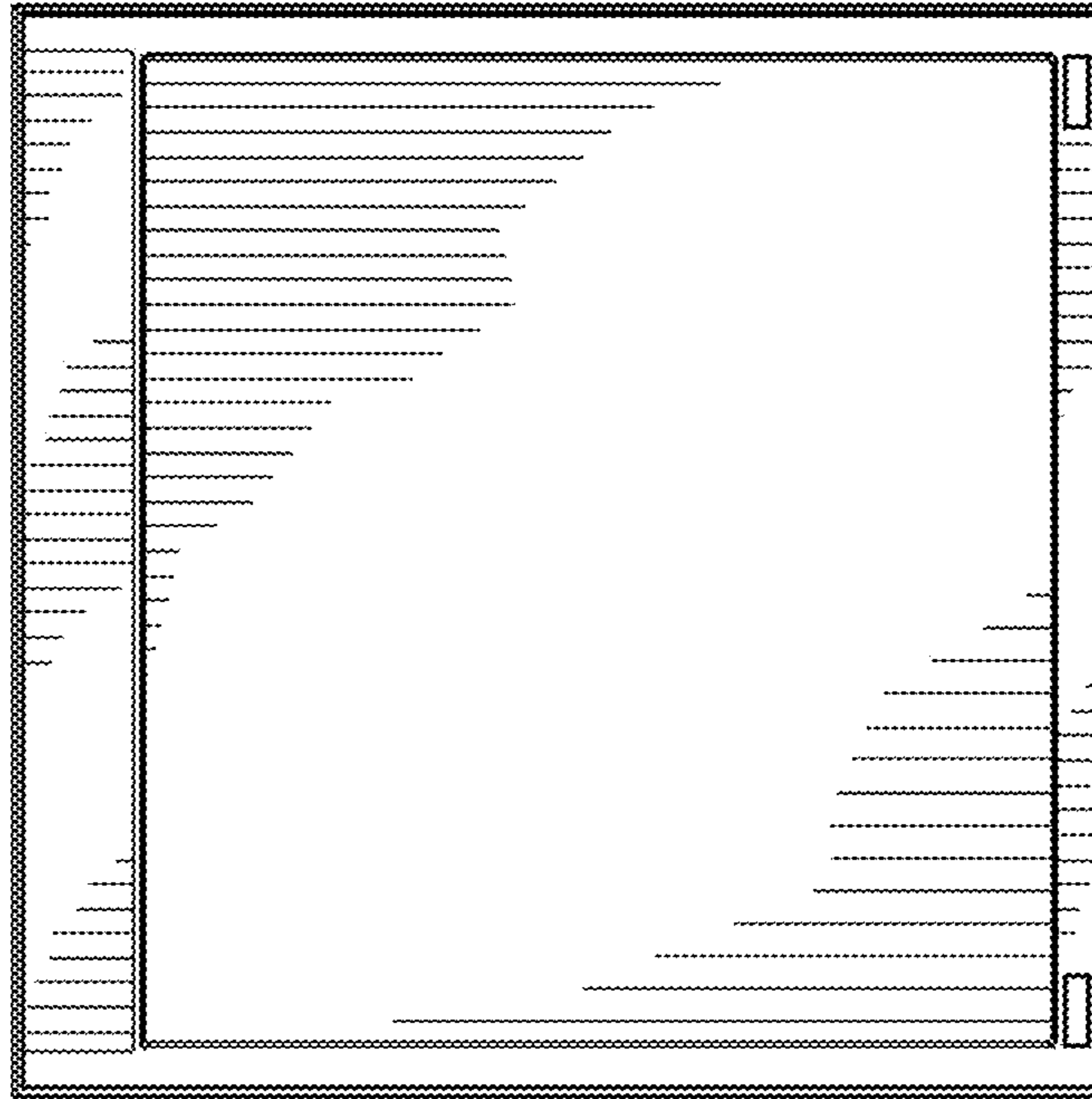

FIG. 4

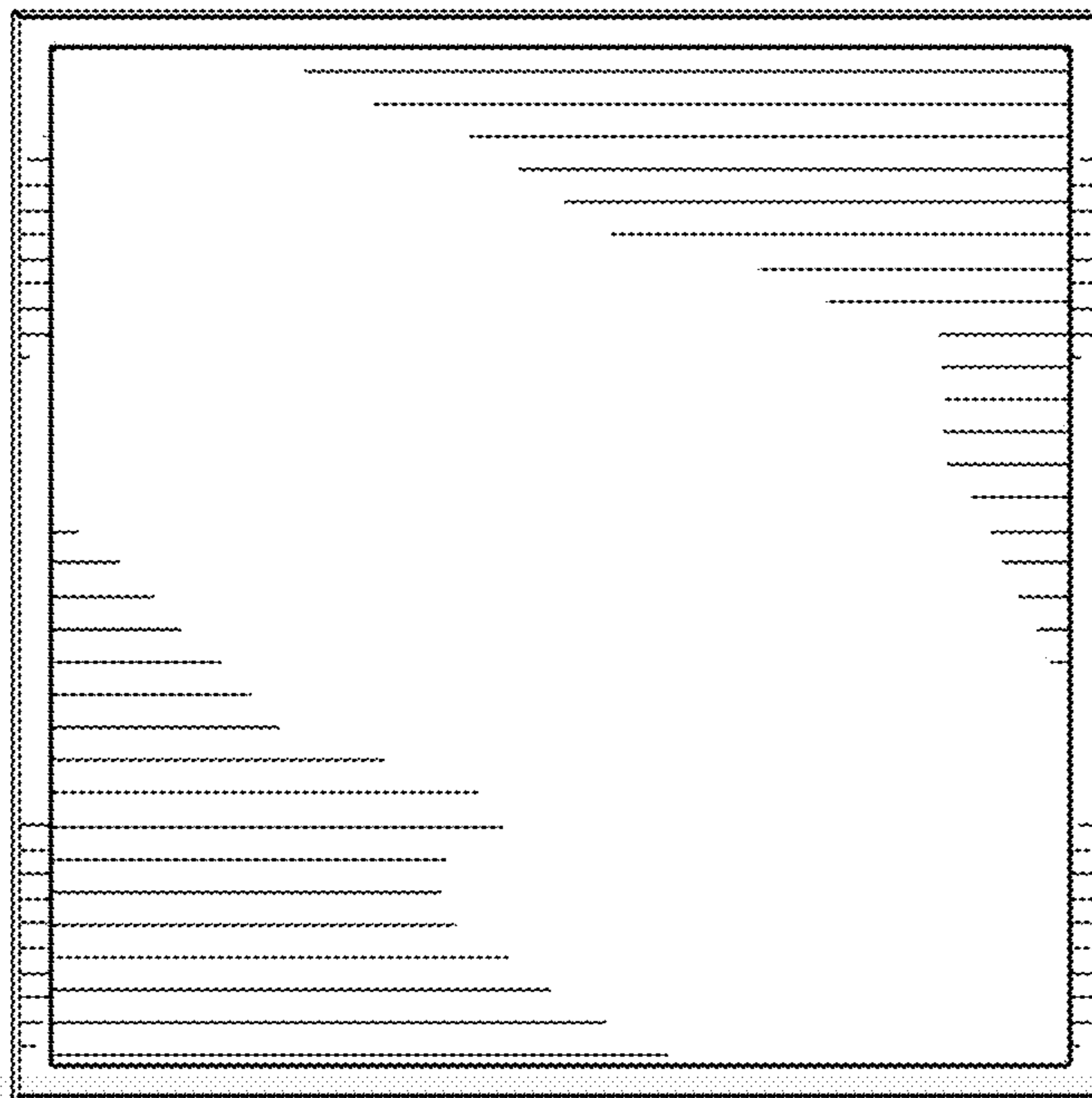

FIG. 3



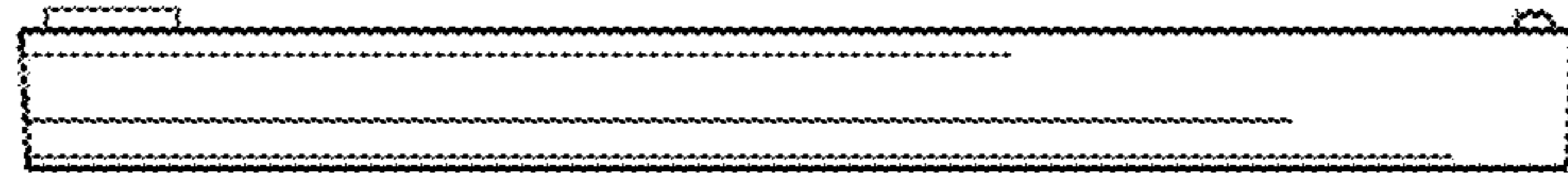

FIG. 6

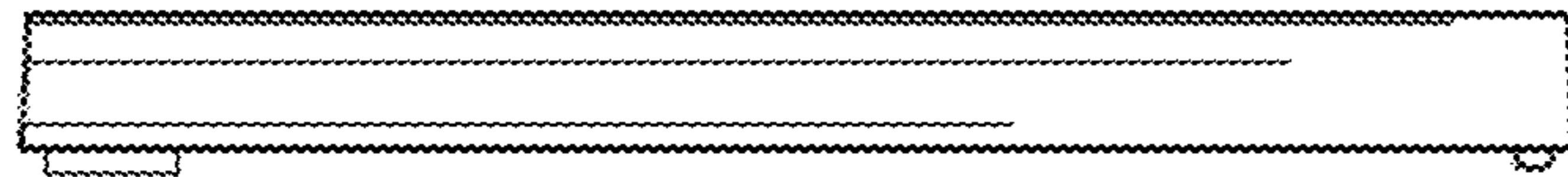

FIG. 5

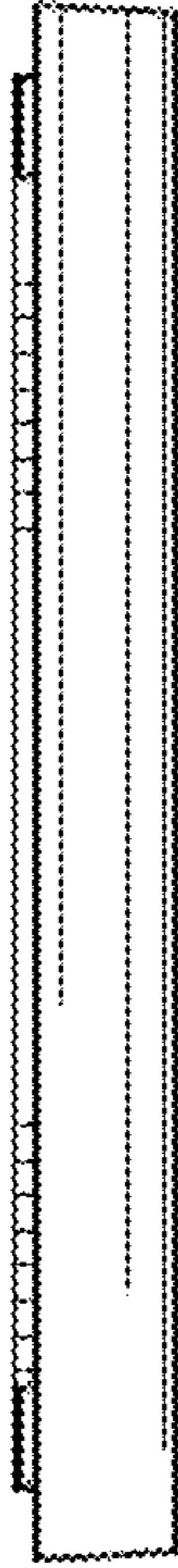

FIG. 7

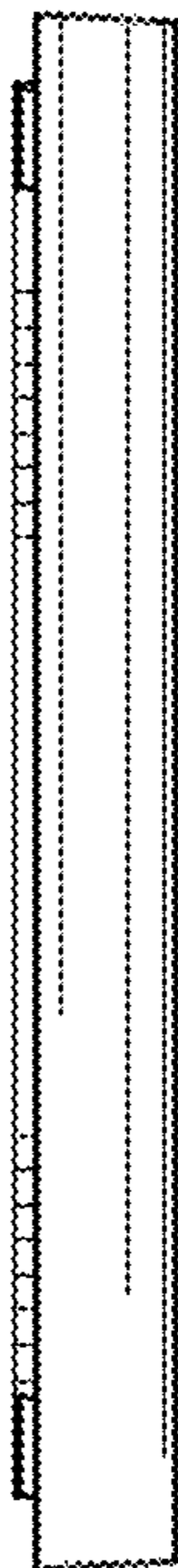

FIG. 8