



US00D909026S

(12) **United States Design Patent**  
**Marvin et al.**

(10) **Patent No.:** **US D909,026 S**

(45) **Date of Patent:** **\*\* Feb. 2, 2021**

(54) **SLIPPER**

(71) Applicant: **Prime Creative, LLC**, Canton, MA (US)

(72) Inventors: **Heather Marvin**, Canton, MA (US);  
**William Marvin**, Canton, MA (US)

(73) Assignee: **Prime Creative, LLC**, Canton, MA (US)

(\*\*) Term: **15 Years**

(21) Appl. No.: **29/682,990**

(22) Filed: **Mar. 8, 2019**

(51) **LOC (13) Cl.** ..... **02-04**

(52) **U.S. Cl.**  
USPC ..... **D2/919**

(58) **Field of Classification Search**  
USPC ..... D2/896-900, 907, 909-912, 919,  
D2/923-925, 946, 969  
CPC .... A43B 5/00; A43B 3/14; A43B 3/16; A43B  
3/101  
See application file for complete search history.

(56) **References Cited**

**U.S. PATENT DOCUMENTS**

4,458,373	A *	7/1984	Maslow	.....	F16G 11/101 12/142 LC
5,335,400	A *	8/1994	Sales	.....	A43C 7/00 24/712.5
D397,545	S *	9/1998	Davidowitz	.....	D2/896
D476,144	S *	6/2003	Adams	.....	D2/969
D738,073	S *	9/2015	Chenciner	.....	D2/903

**OTHER PUBLICATIONS**

U.S. Appl. No. 16/811,799, filed Mar 6, 2020, Marvin.  
[No Author Listed] Photos of Athletic Shoes. Publicly available prior to Mar. 8, 2019, 2 pages.

[No Author Listed] Photos of Hotel Slippers. Publicly available prior to Mar. 8, 2019, 1 page.

[No Author Listed] Photos of Shoes. Publicly available prior to Mar. 8, 2019, 1 page.

[No Author Listed] Photos of Slippers. Publicly available prior to Mar. 8, 2019, 1 page.

\* cited by examiner

*Primary Examiner* — Rashida C. Walshon

(74) *Attorney, Agent, or Firm* — Wolf, Greenfield & Sacks, P.C.

(57) **CLAIM**

The ornamental design for a slipper, as shown and described.

**DESCRIPTION**

FIG. 1 is a top, front, left-side perspective view of a slipper according to our new design;  
FIG. 2 is a front elevation view thereof;  
FIG. 3 is a rear elevation view thereof;  
FIG. 4 is a left-side elevation view thereof;  
FIG. 5 is a right-side elevation view thereof;  
FIG. 6 is a top plan view thereof;  
FIG. 7 is a bottom plan view thereof;  
FIG. 8 is a top, front, left-side perspective view of a second embodiment thereof;  
FIG. 9 is a front elevation view of FIG. 8;  
FIG. 10 is a rear elevation view of FIG. 8;  
FIG. 11 is a left-side elevation view of FIG. 8;  
FIG. 12 is a right-side elevation view of FIG. 8;  
FIG. 13 is a top plan view of FIG. 8; and  
FIG. 14 is a bottom plan view of FIG. 8.  
The dashed lines shown around the eyelets of the slipper in FIGS. 1, 2, 4-6, and in the bottom view of the slipper in FIG. 7 represent stitching and forms part of the claimed design. All other dashed lines represent unclaimed portions of the slipper and form no part of the claimed design.

**1 Claim, 14 Drawing Sheets**

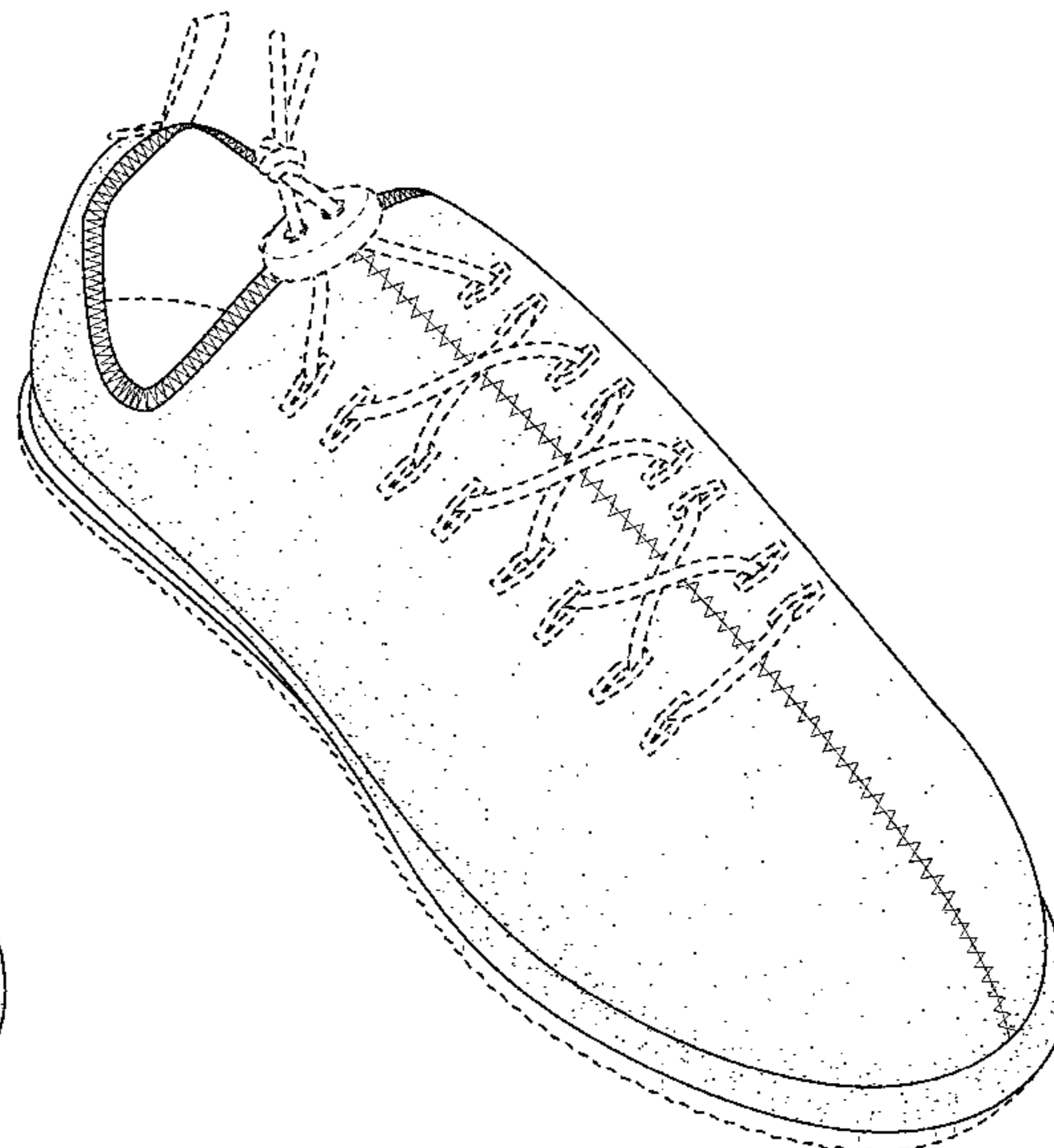

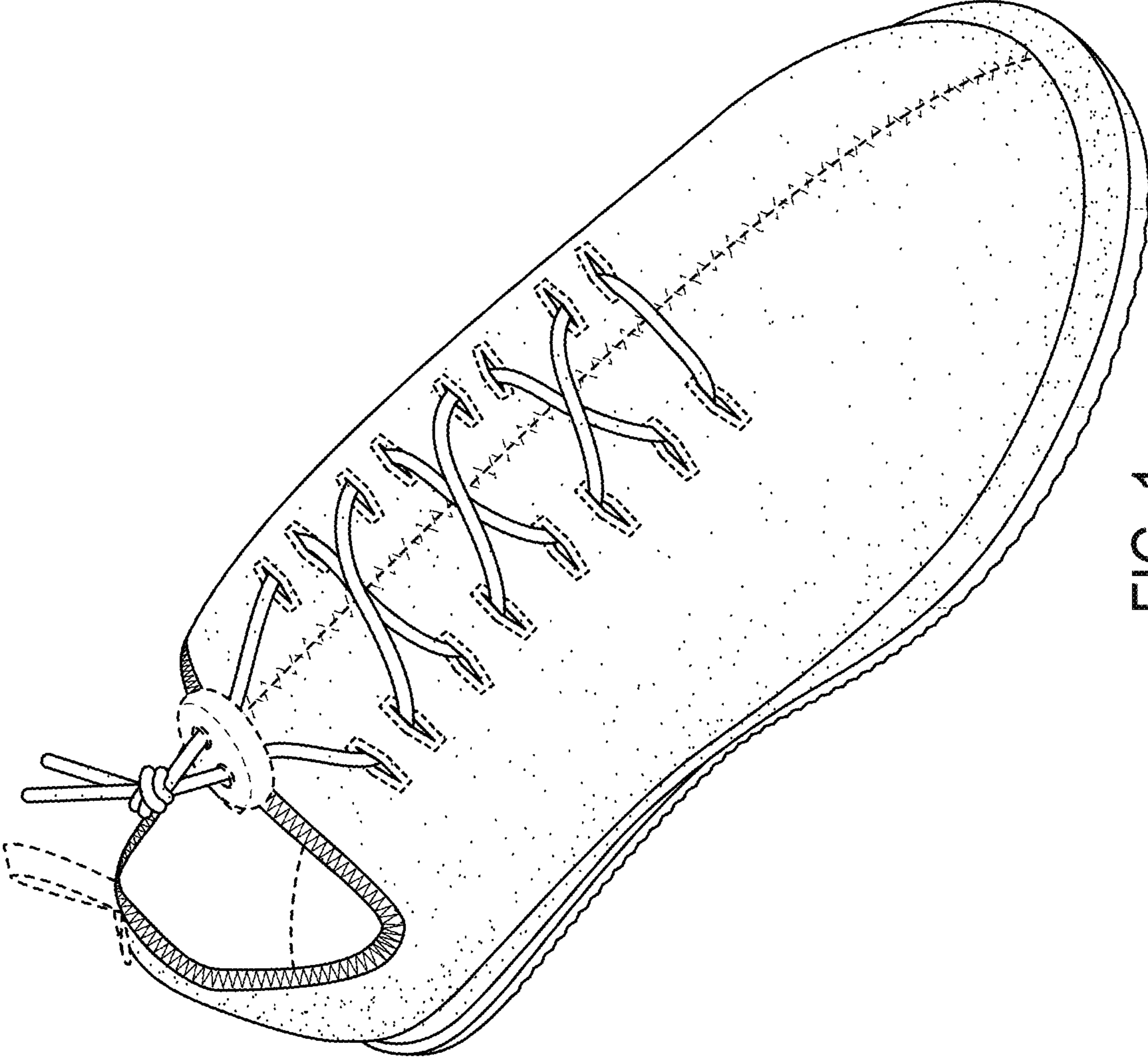

FIG. 1

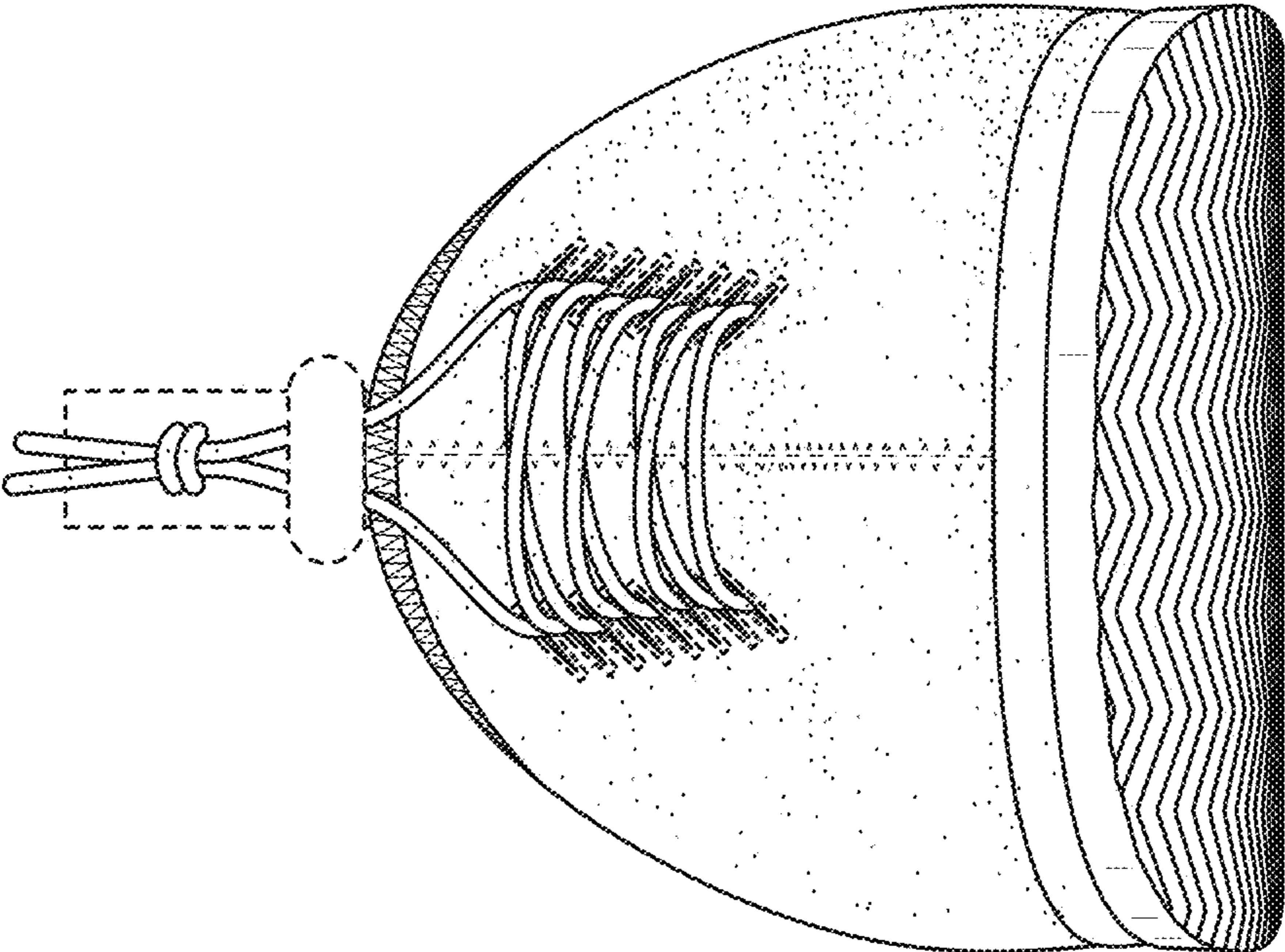

FIG. 2

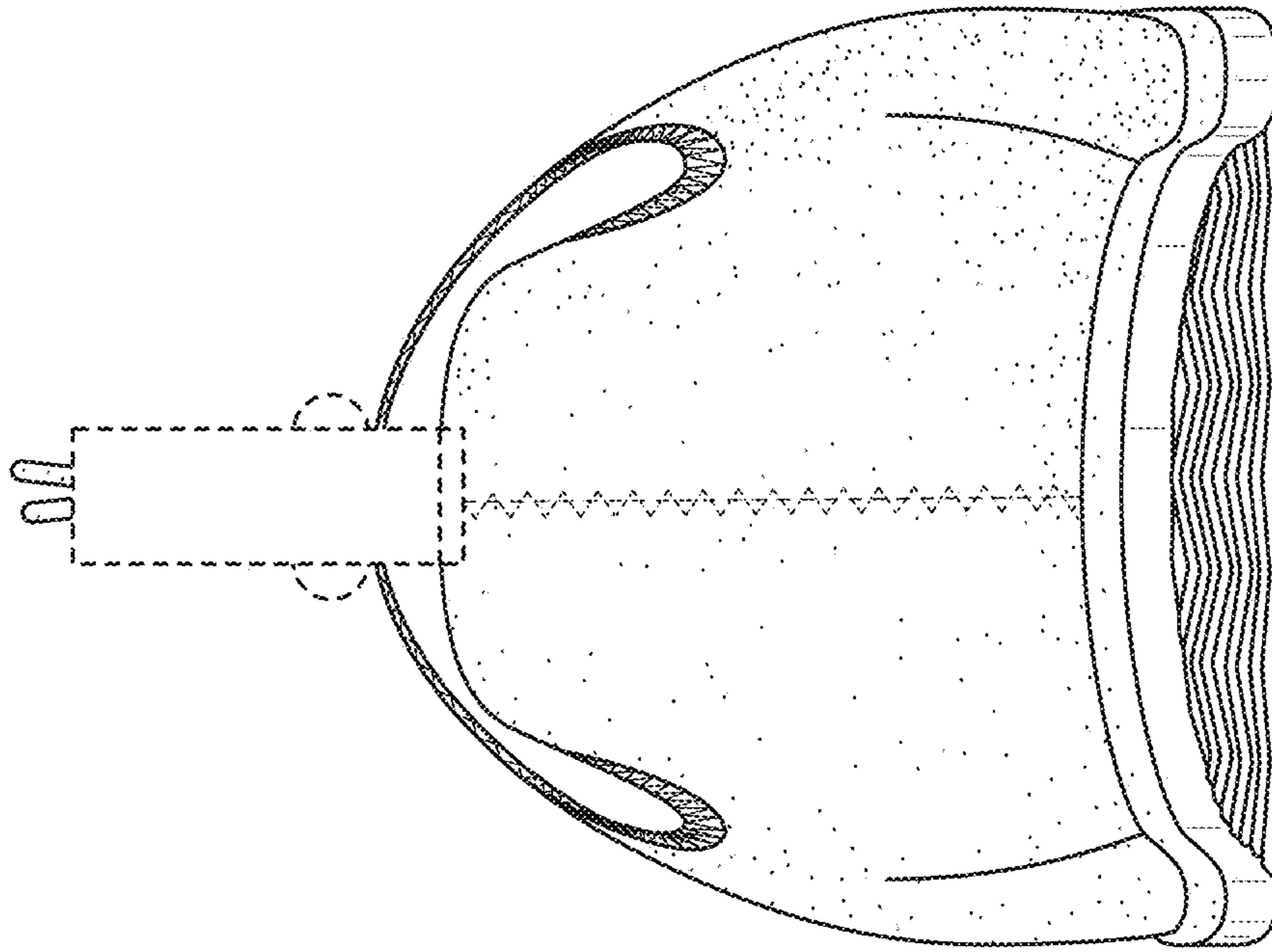

FIG. 3

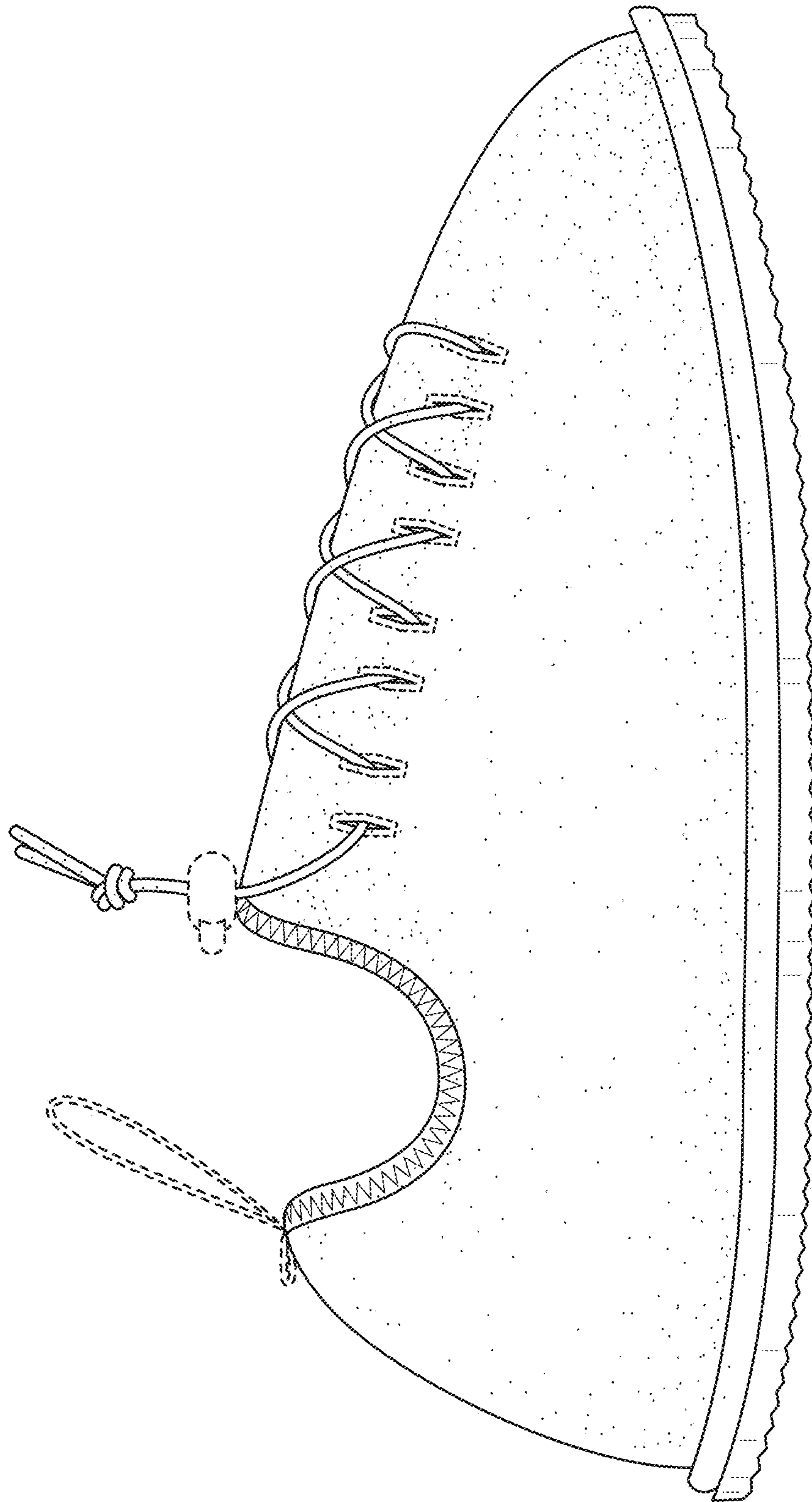

FIG. 4

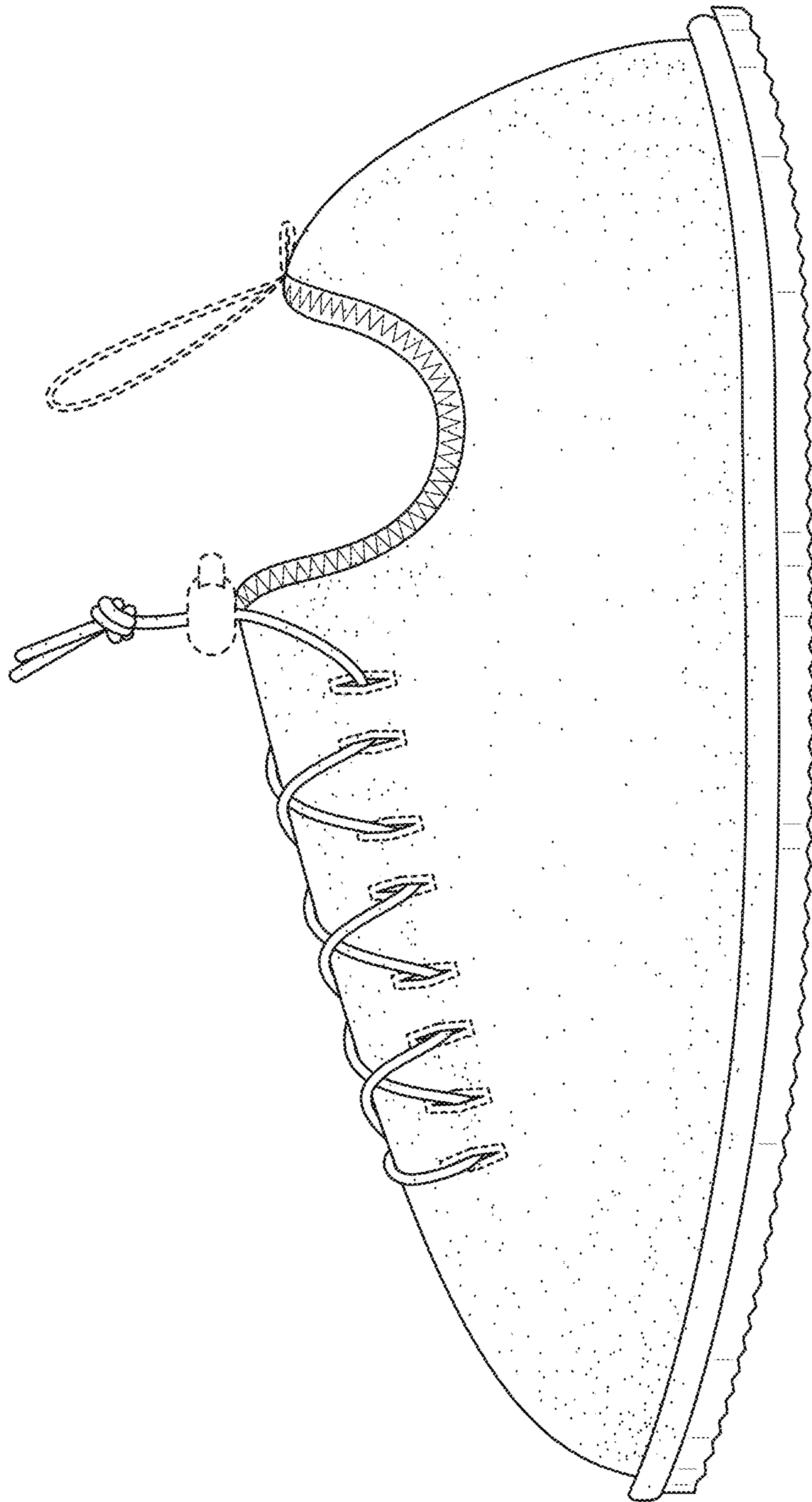

FIG. 5

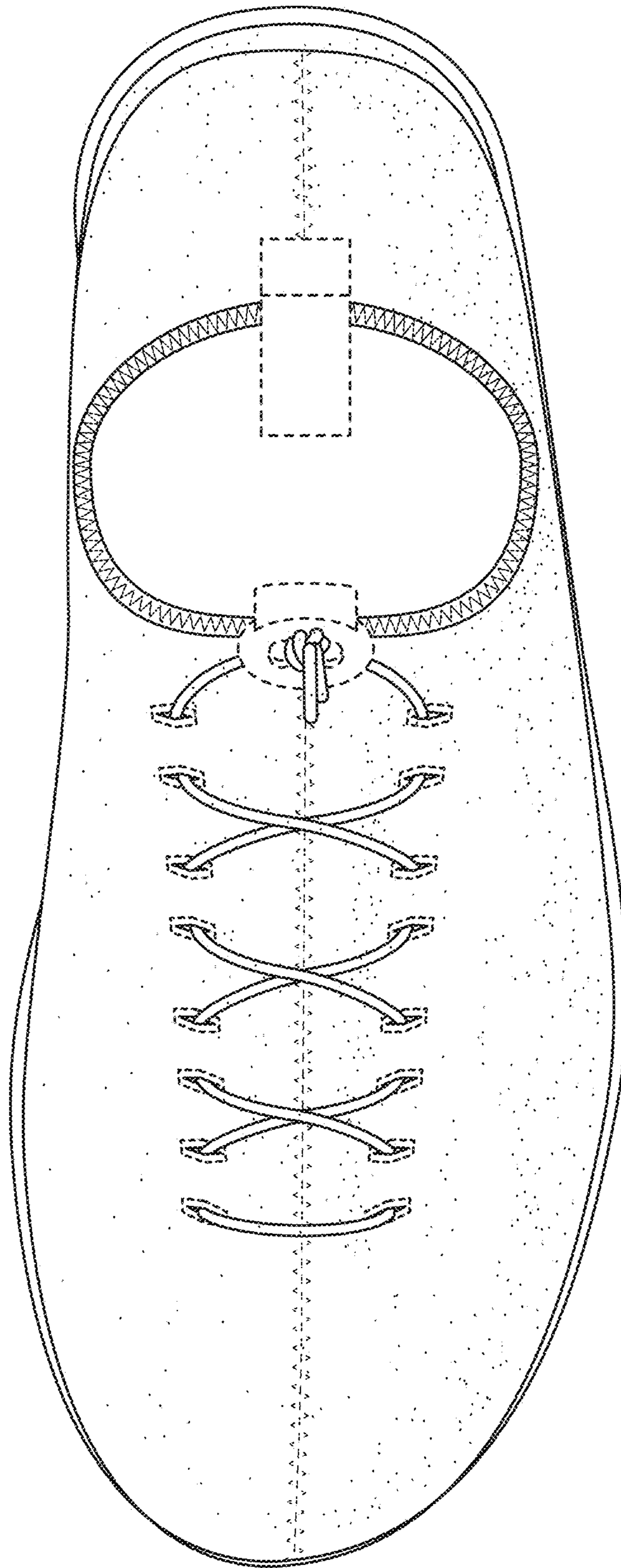

FIG. 6

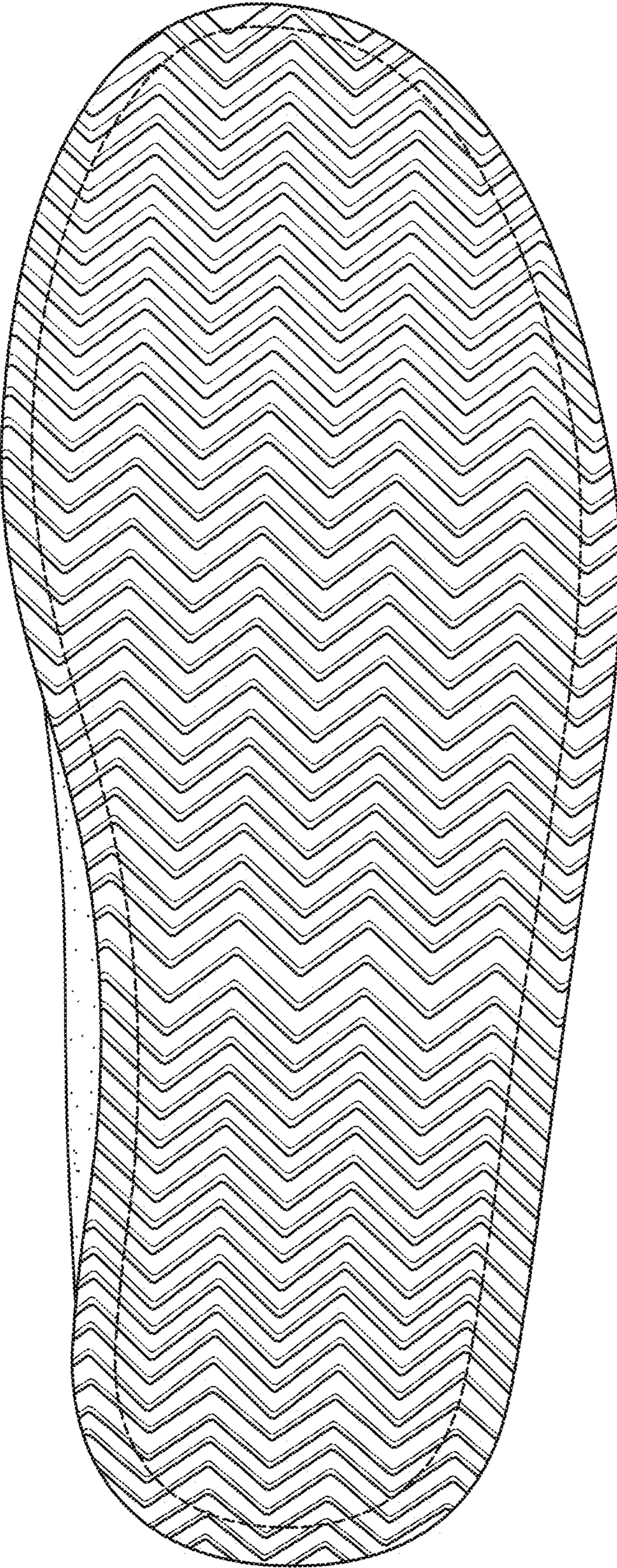

FIG. 7



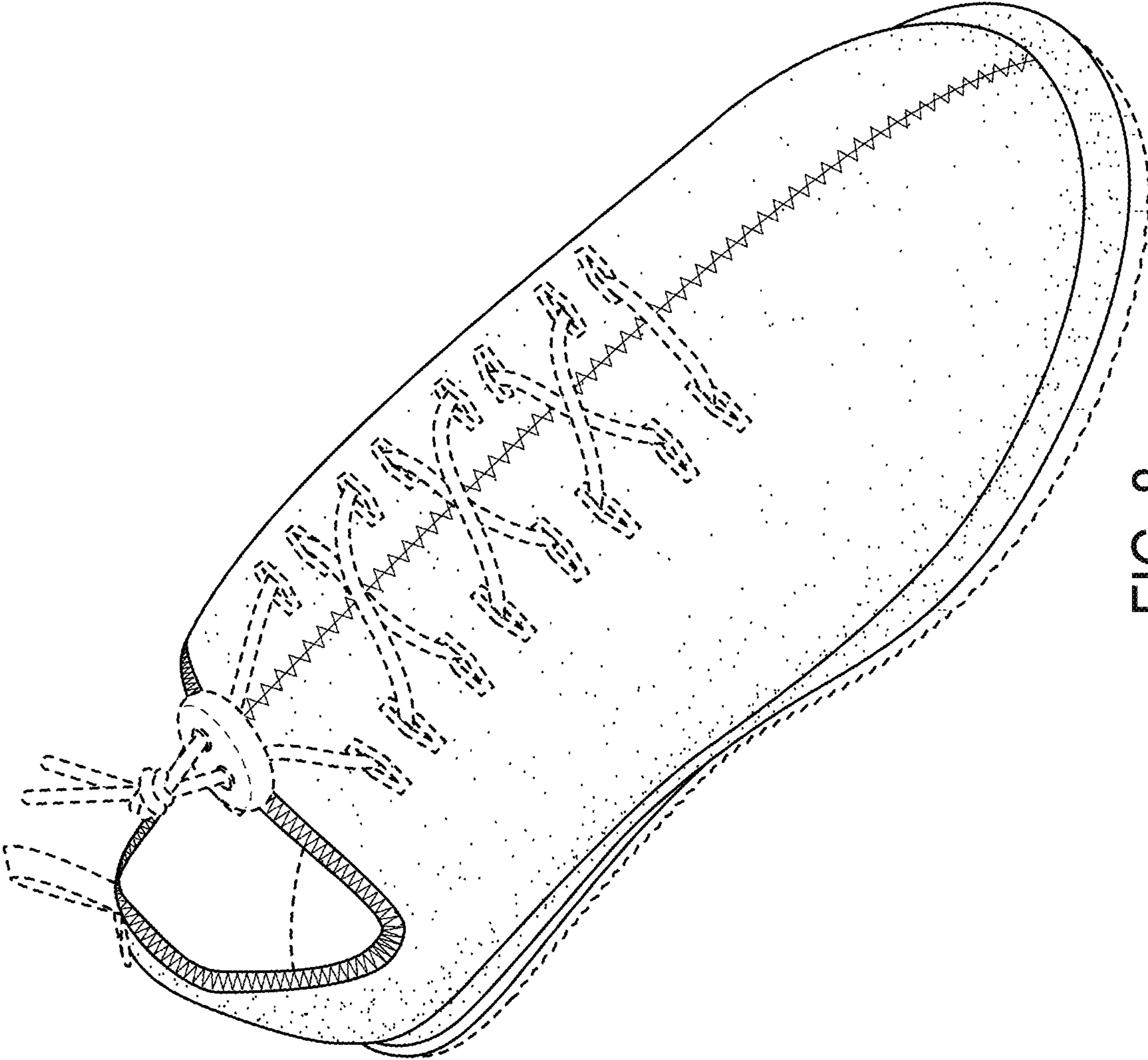

FIG. 8

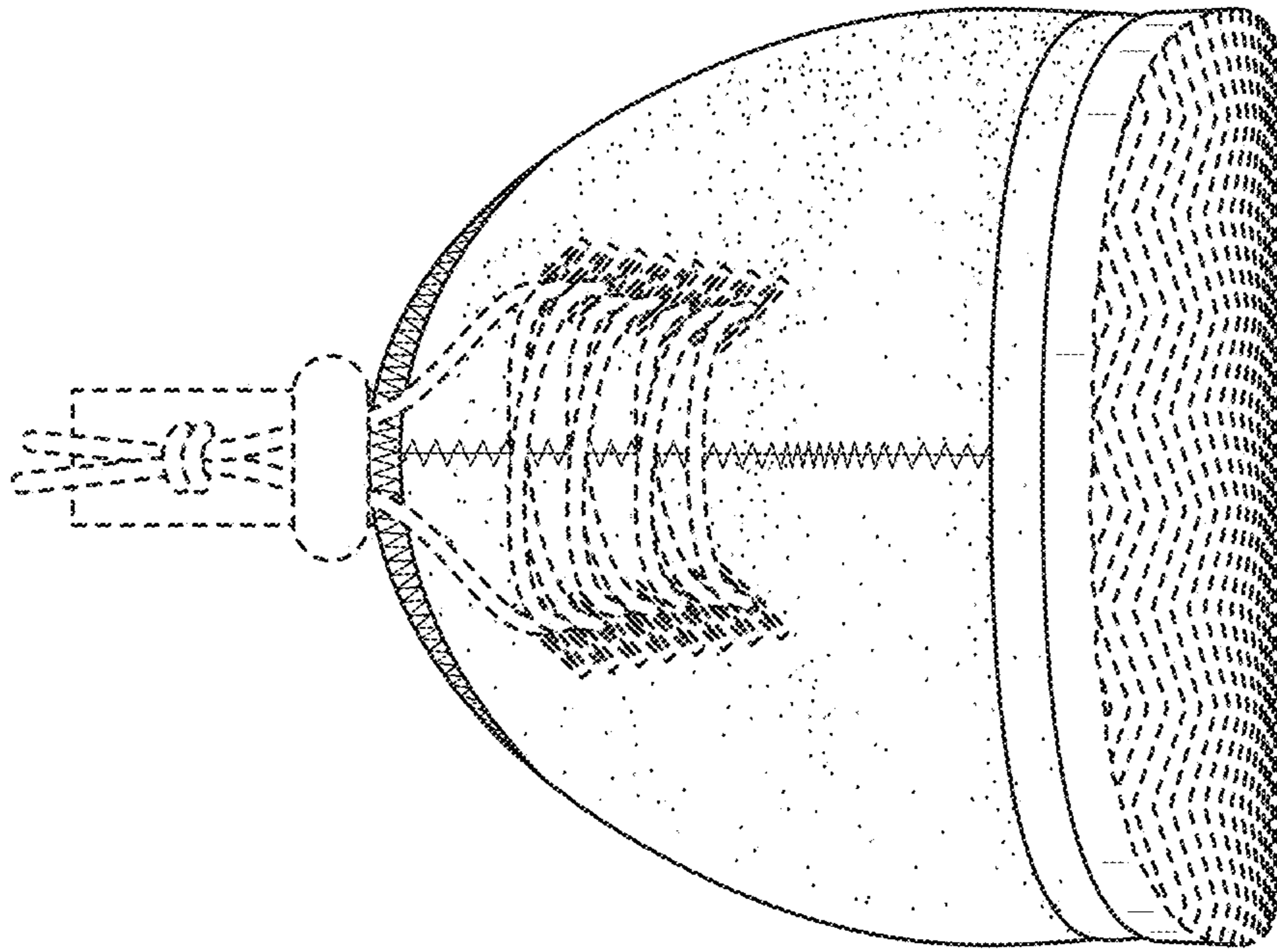

FIG. 9

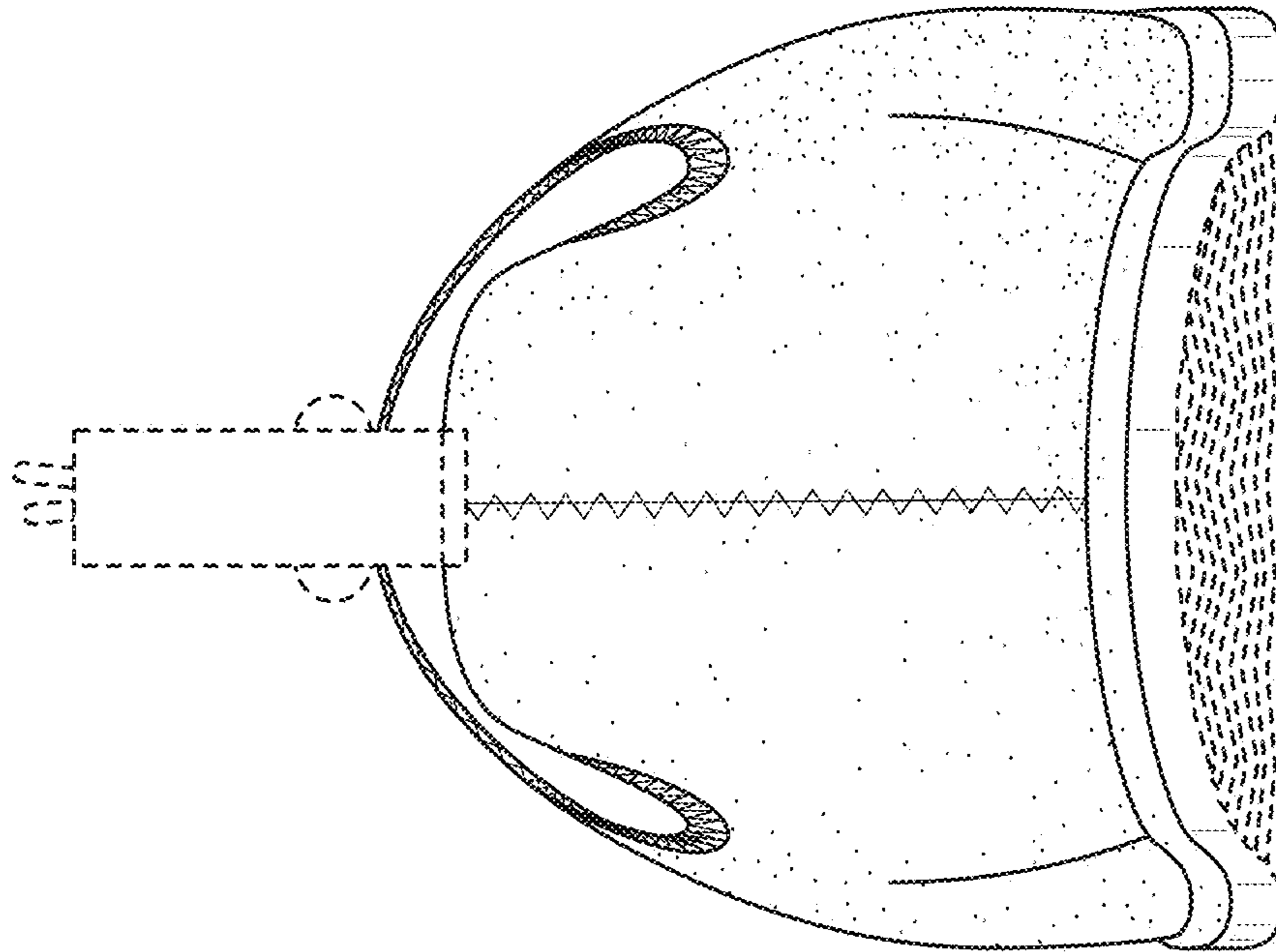

FIG. 10

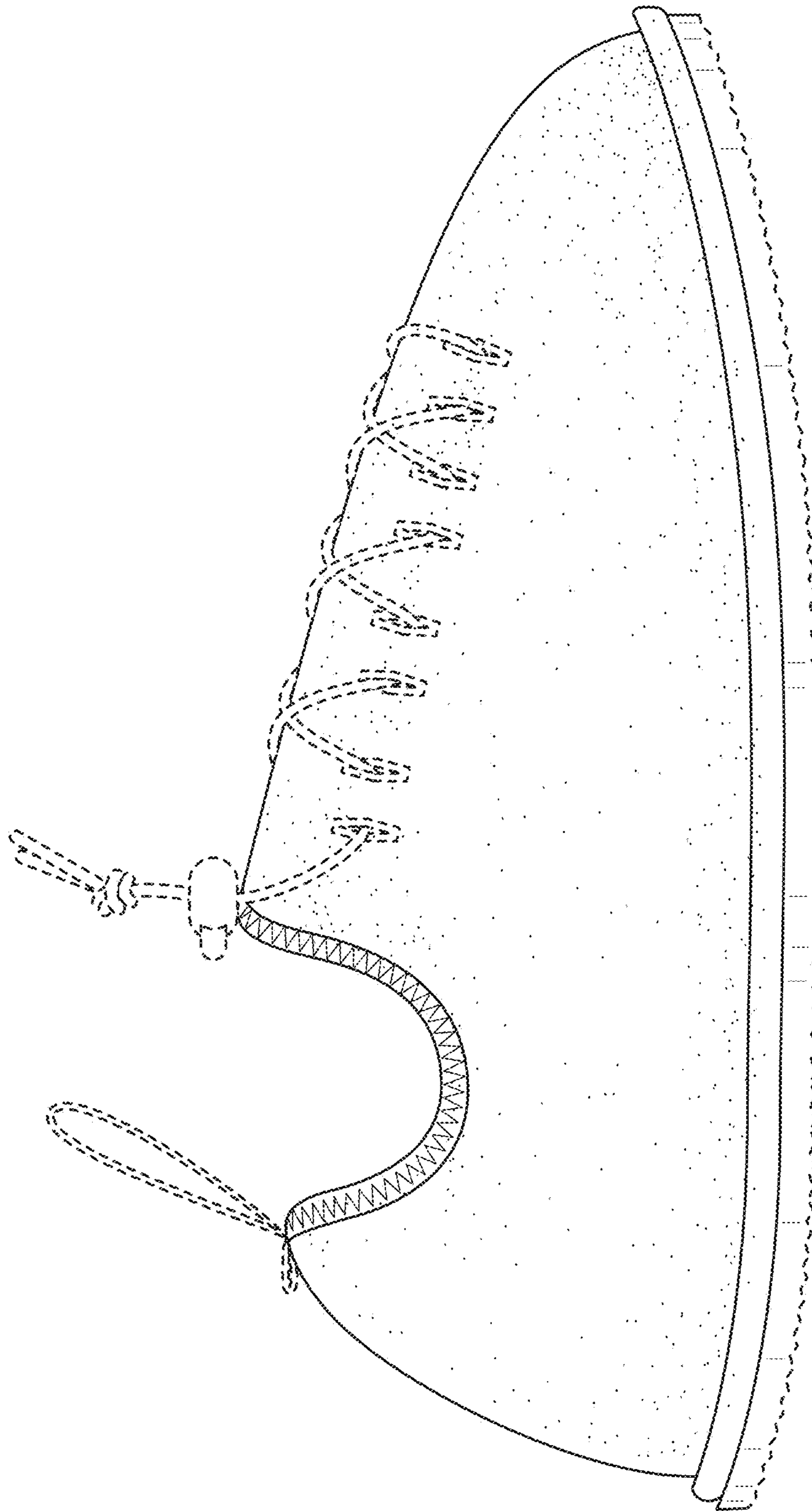

FIG. 11

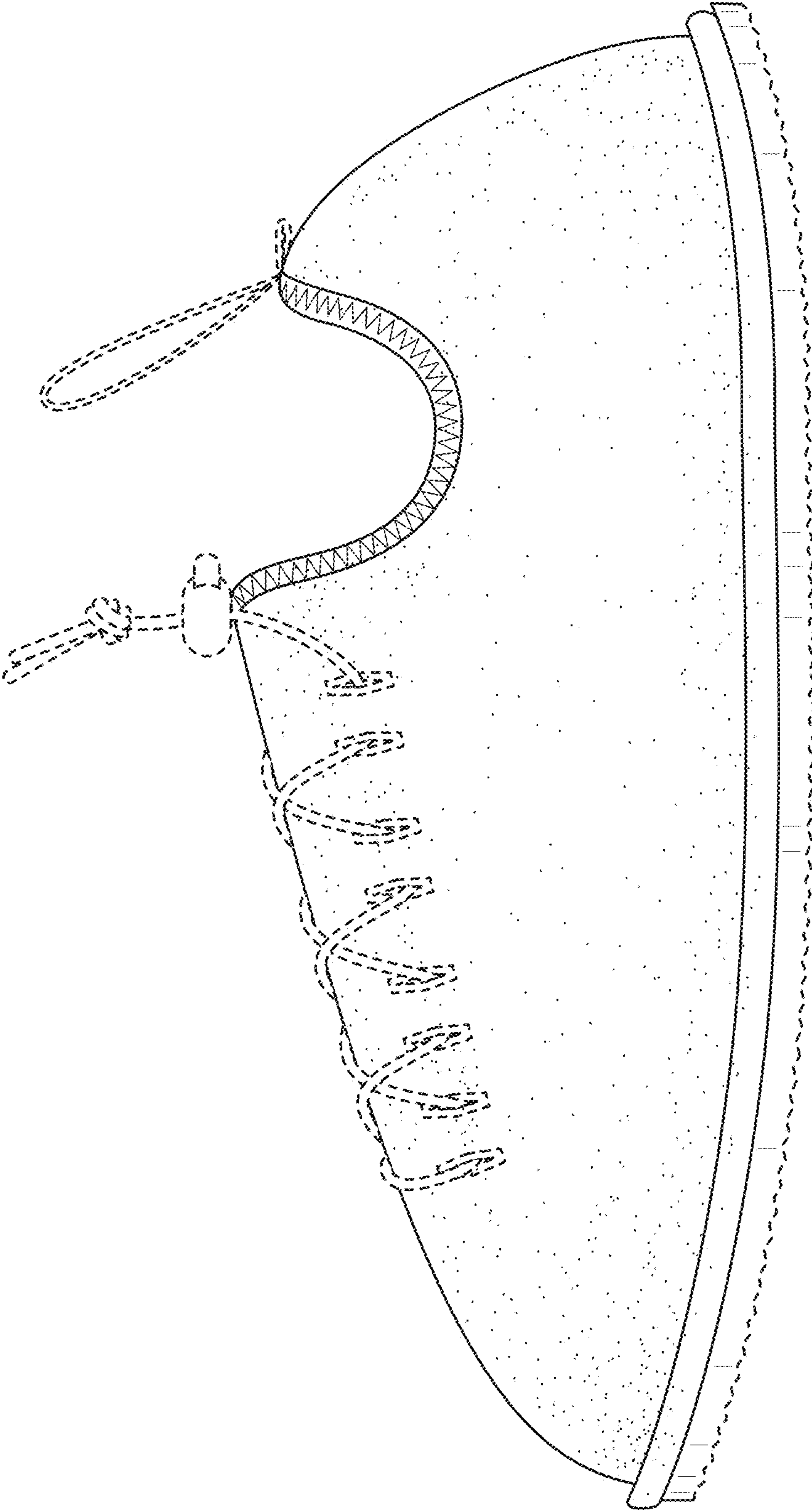

FIG. 12

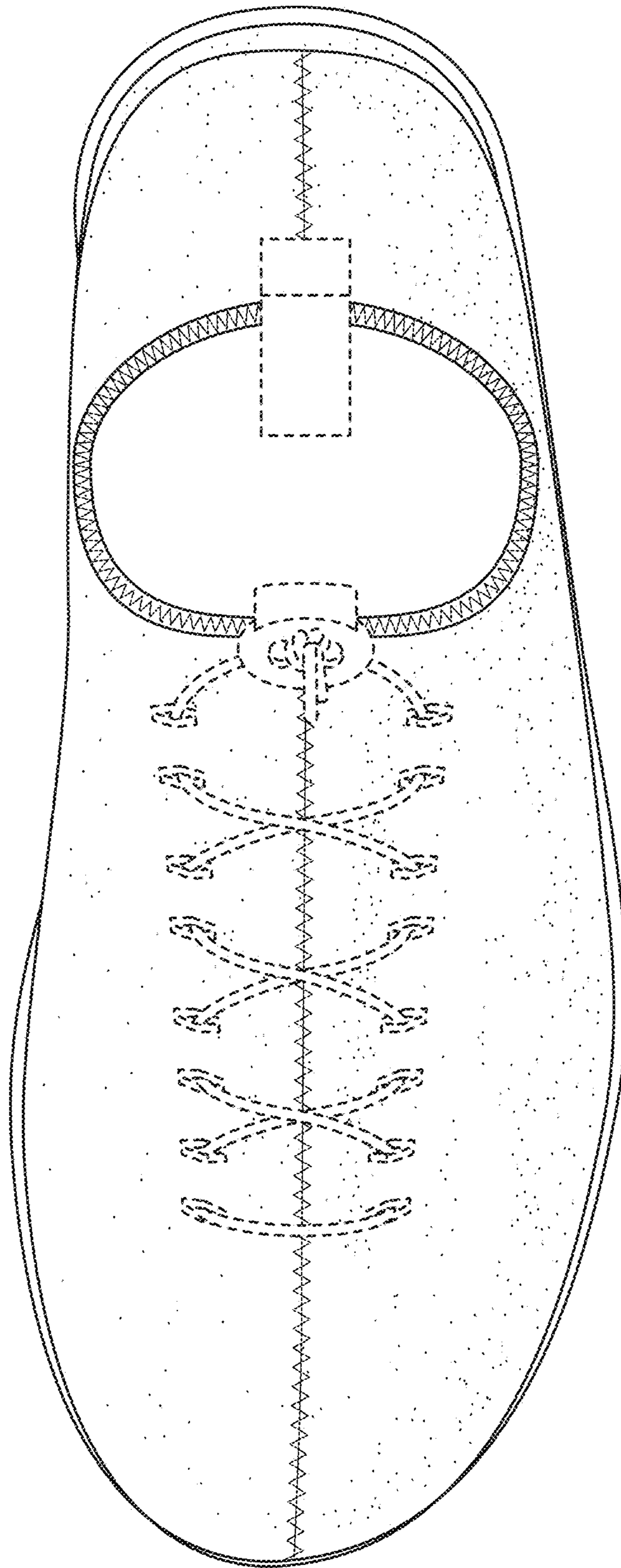

FIG. 13

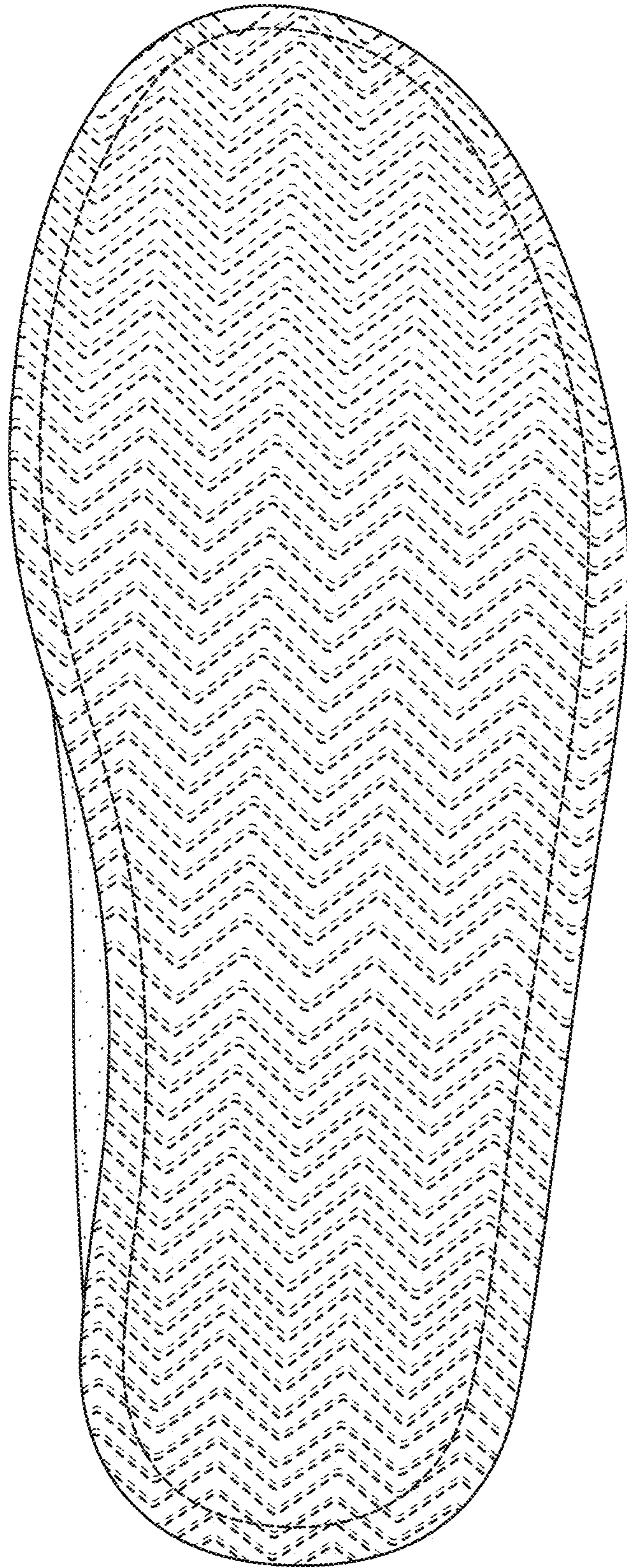

FIG. 14