



US00D908957S

(12) **United States Design Patent**
Huang

(10) **Patent No.:** **US D908,957 S**

(45) **Date of Patent:** **** Jan. 26, 2021**

(54) **EPILATOR**

(71) Applicant: **Shenzhen Bosidi Technology Co., Ltd.**, Shenzhen (CN)

(72) Inventor: **Guoli Huang**, Fujian (CN)

(**) Term: **15 Years**

(21) Appl. No.: **29/714,065**

(22) Filed: **Nov. 21, 2019**

(51) **LOC (13) Cl.** **28-03**

(52) **U.S. Cl.**
USPC **D28/44.1**; D24/209; D24/214

(58) **Field of Classification Search**
USPC D28/44.1, 53, 54, 51; D24/209, 214
CPC A61B 2018/0047; A61B 2018/0452; A61B 2018/202; A61B 2018/0476; A45D 26/0023-0038; A45D 26/0004-0009; A45D 26/0057

See application file for complete search history.

(56) **References Cited**

U.S. PATENT DOCUMENTS

D660,448 S *	5/2012	Lum	D24/209
D808,076 S *	1/2018	Gabriele	D28/44.1
D828,571 S *	9/2018	Lee	D24/214
D843,656 S *	3/2019	Zhang	D28/44.1
D844,896 S *	4/2019	Levi	D28/44.1
D863,578 S *	10/2019	Yan	D24/209

D864,405 S *	10/2019	Yan	D24/209
D895,206 S *	9/2020	Huang	D28/44.1
D895,207 S *	9/2020	Huang	D28/44.1
D895,897 S *	9/2020	Huang	D28/44.1
2004/0167481 A1 *	8/2004	Carlucci	A45D 26/0004 604/291

* cited by examiner

Primary Examiner — Jennifer Rivard

(74) *Attorney, Agent, or Firm* — Prakash Nama; Global IP Services, PLLC

(57) **CLAIM**

The ornamental design for an epilator, as shown.

DESCRIPTION

FIG. 1 is a front elevational view of an epilator showing my new design;
FIG. 2 is a rear elevational view thereof;
FIG. 3 is a left side view thereof;
FIG. 4 is a right side view thereof;
FIG. 5 is a top plan view thereof;
FIG. 6 is a bottom plan view thereof;
FIG. 7 is a perspective view thereof;
FIG. 8 is a second perspective view thereof;
FIG. 9 is a third perspective view thereof; and,
FIG. 10 is a fourth perspective view thereof.

1 Claim, 8 Drawing Sheets

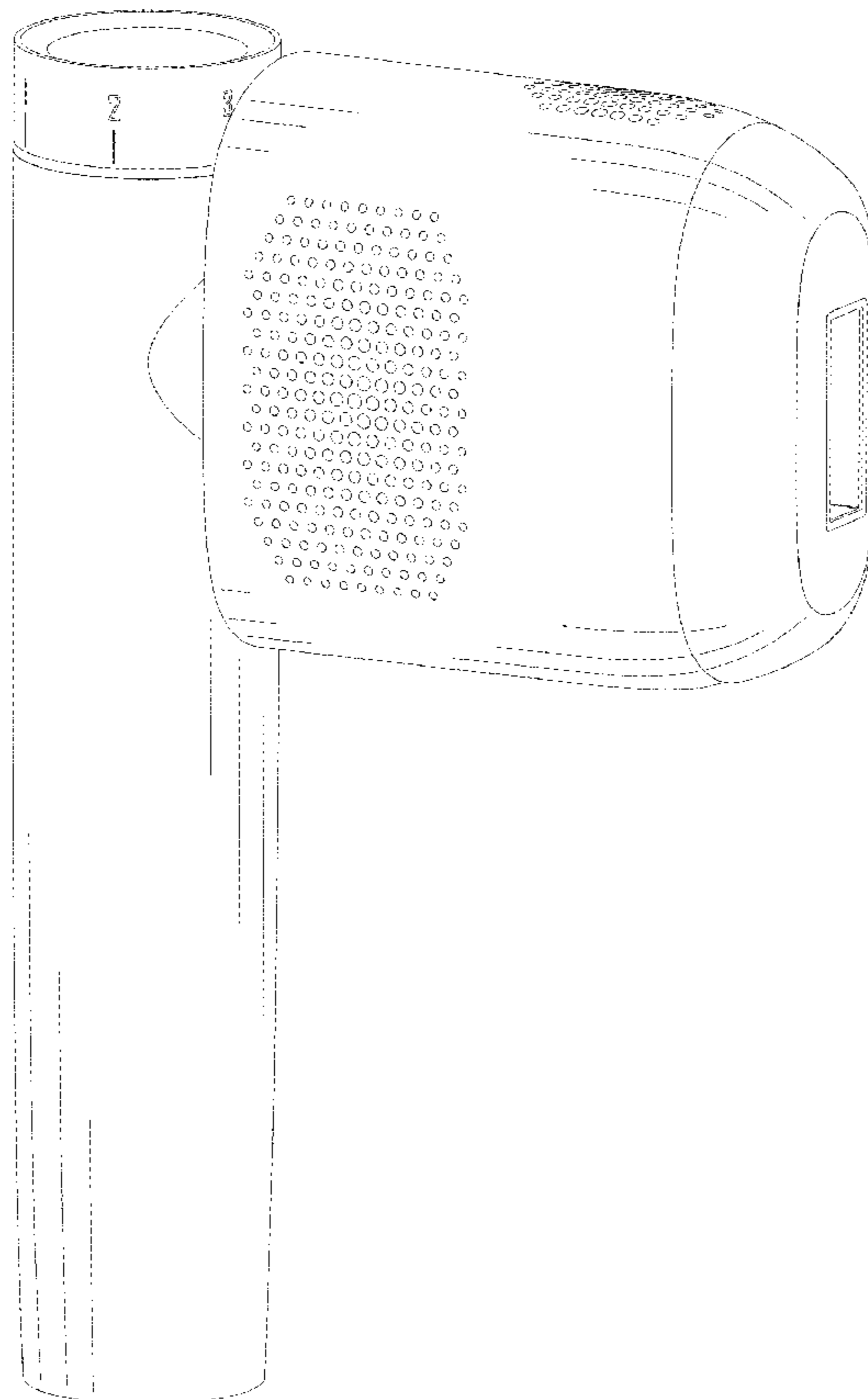

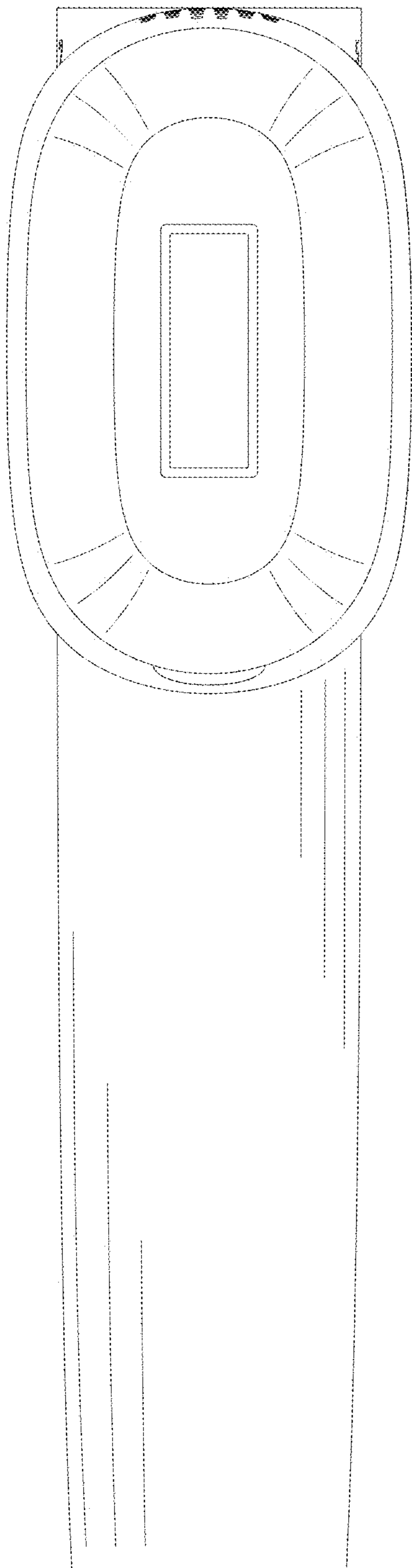

Fig. 1

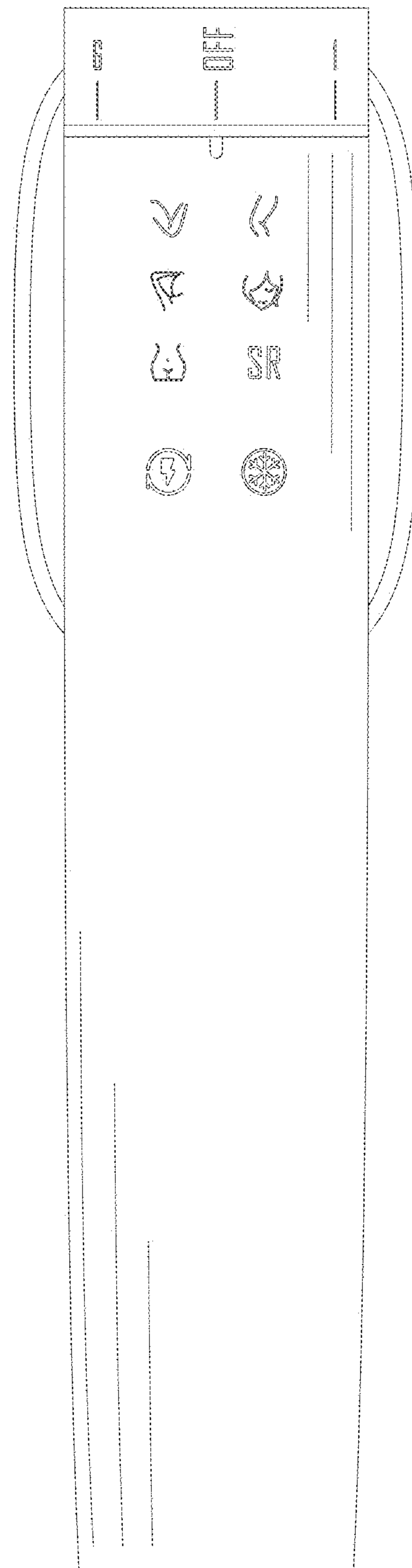

Fig. 2

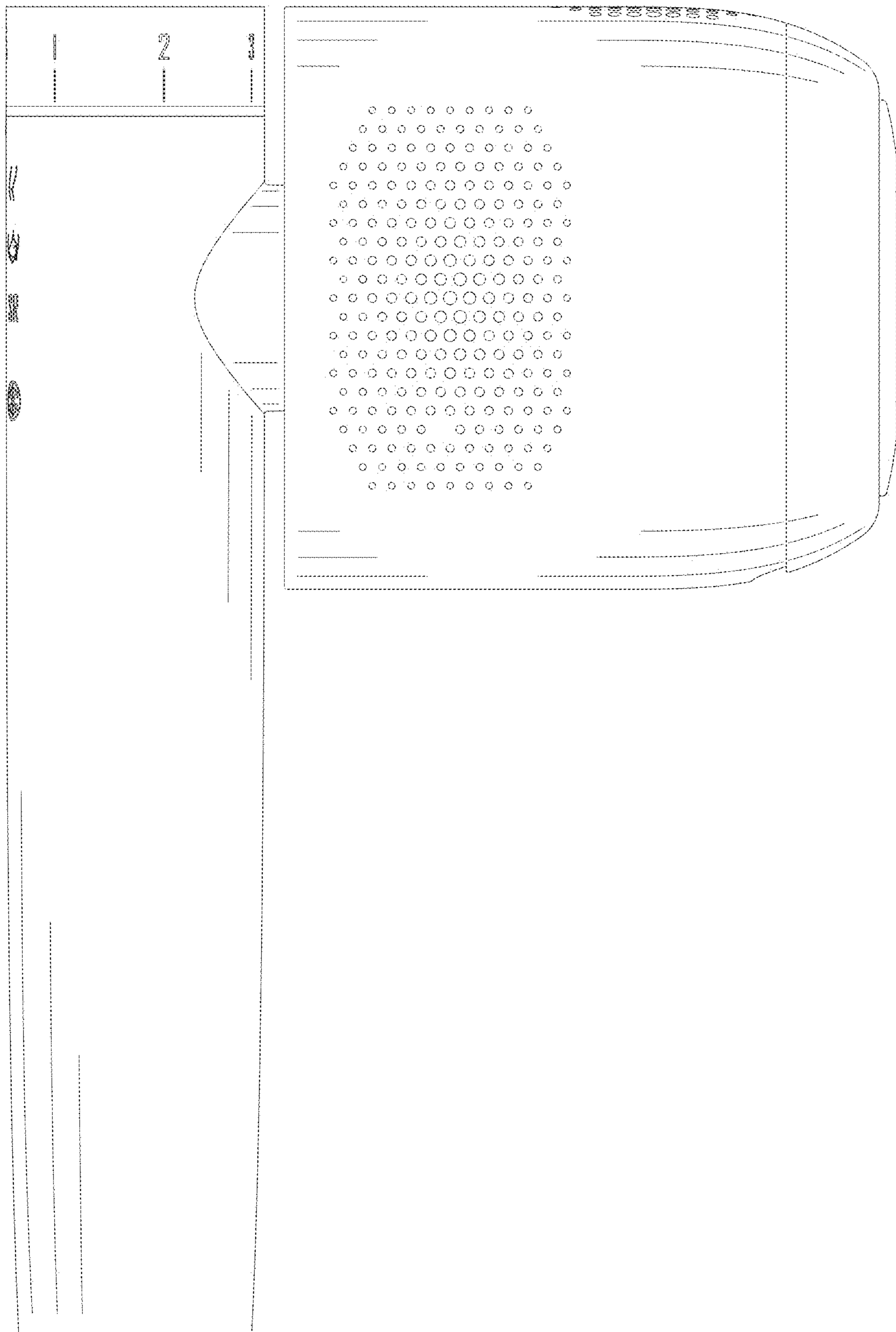

Fig.3

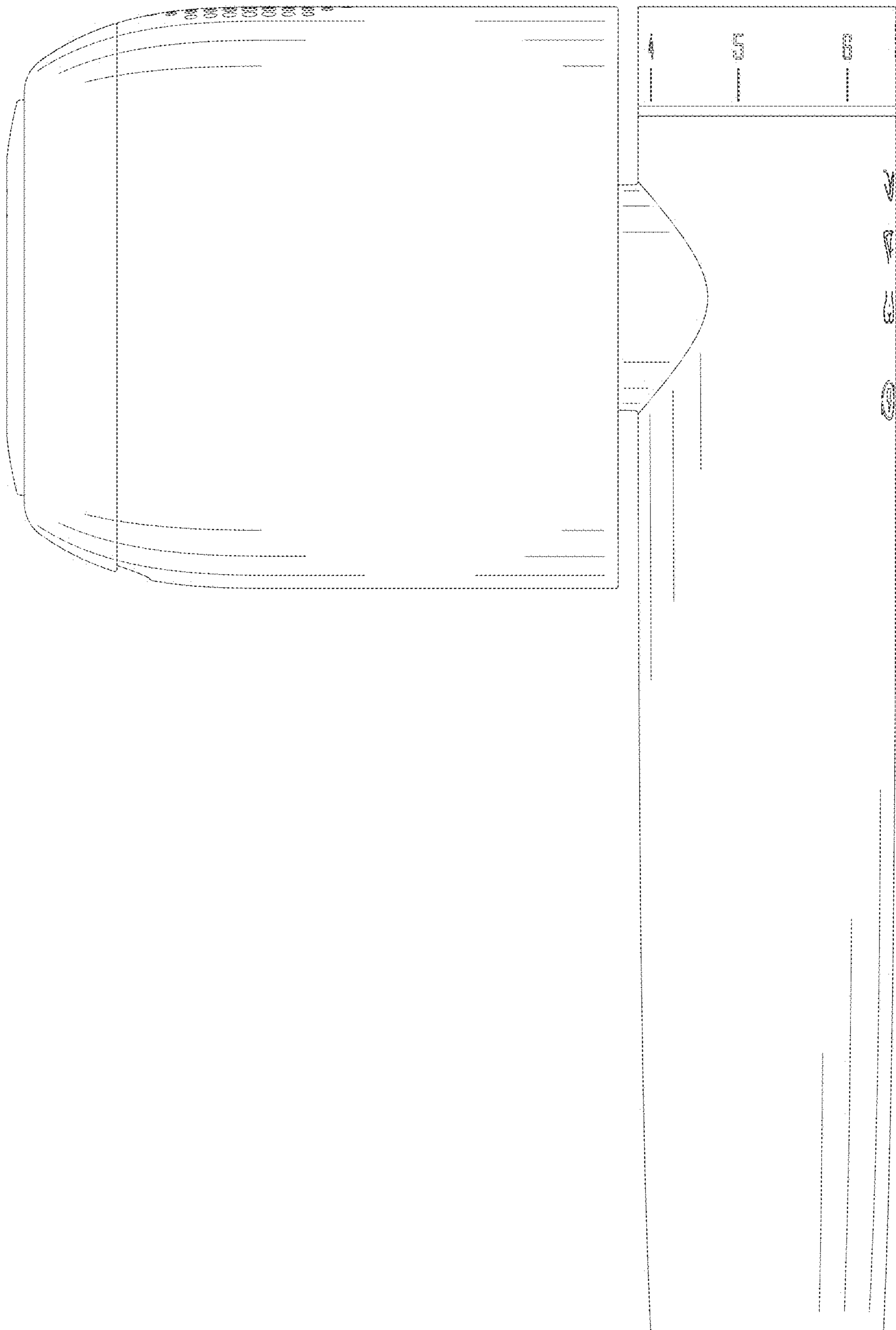

Fig.4

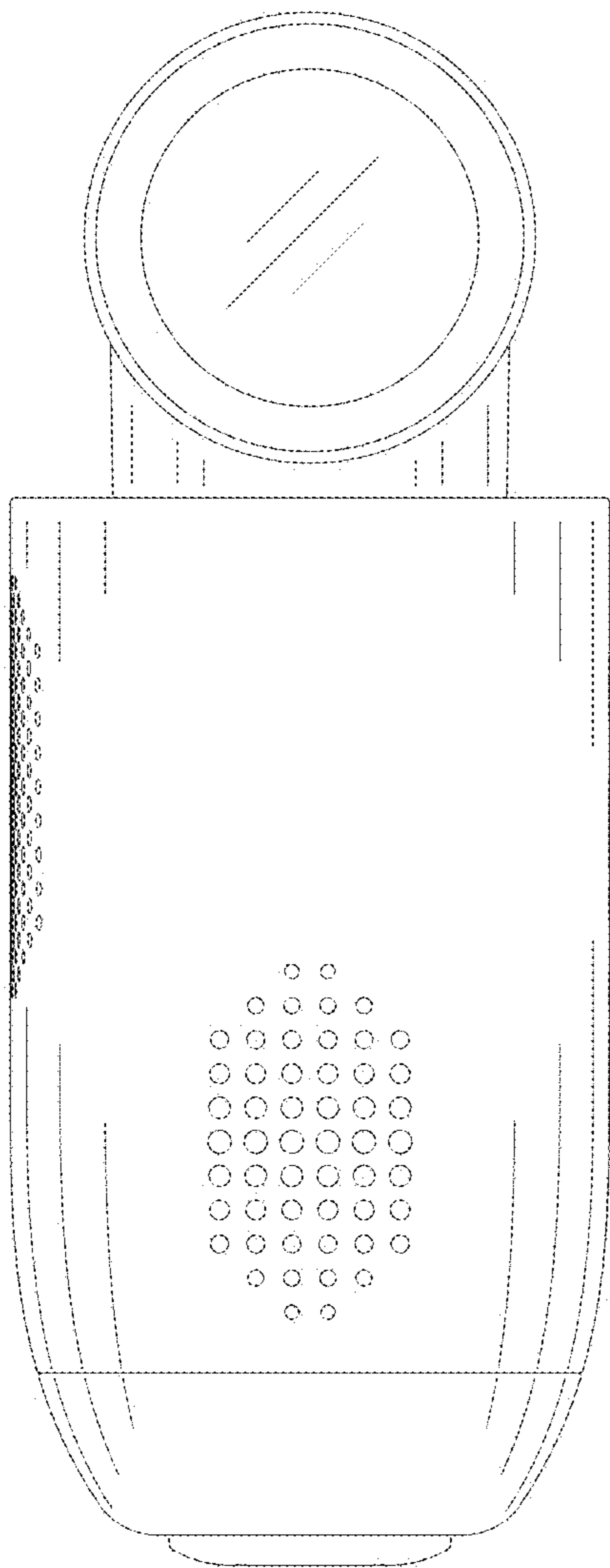

Fig.5

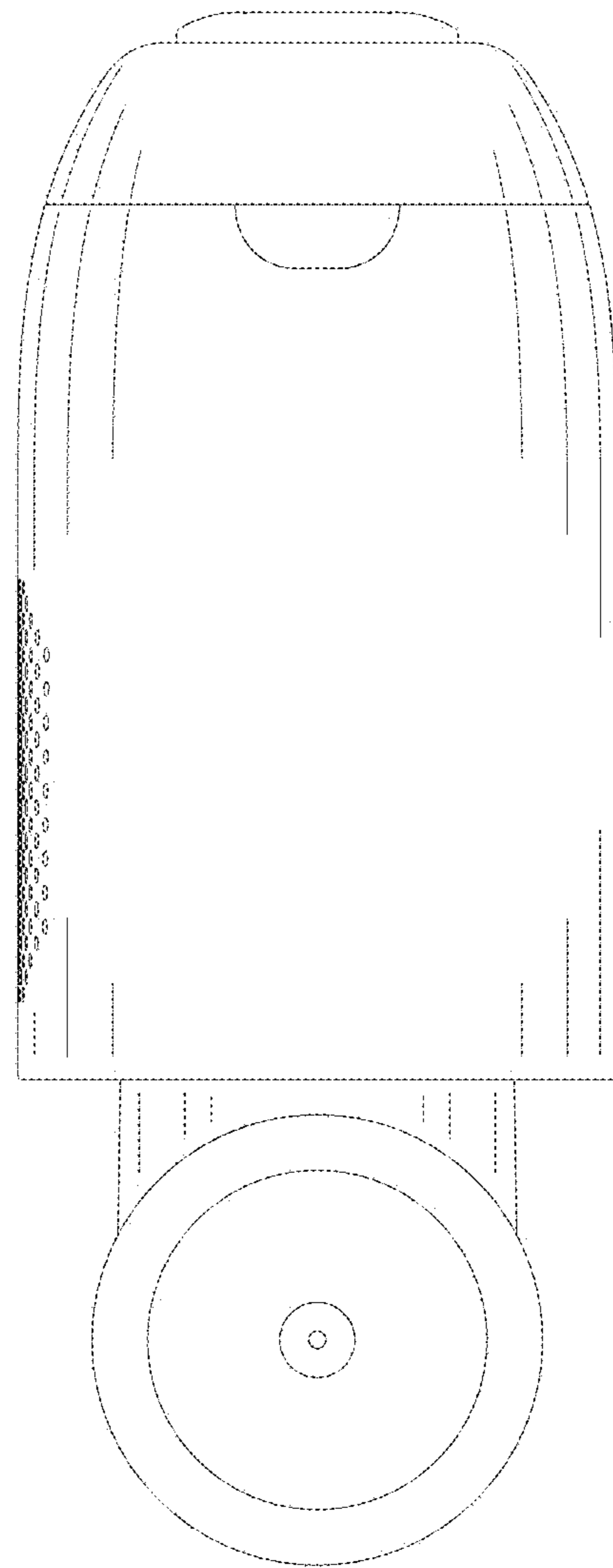

Fig.6

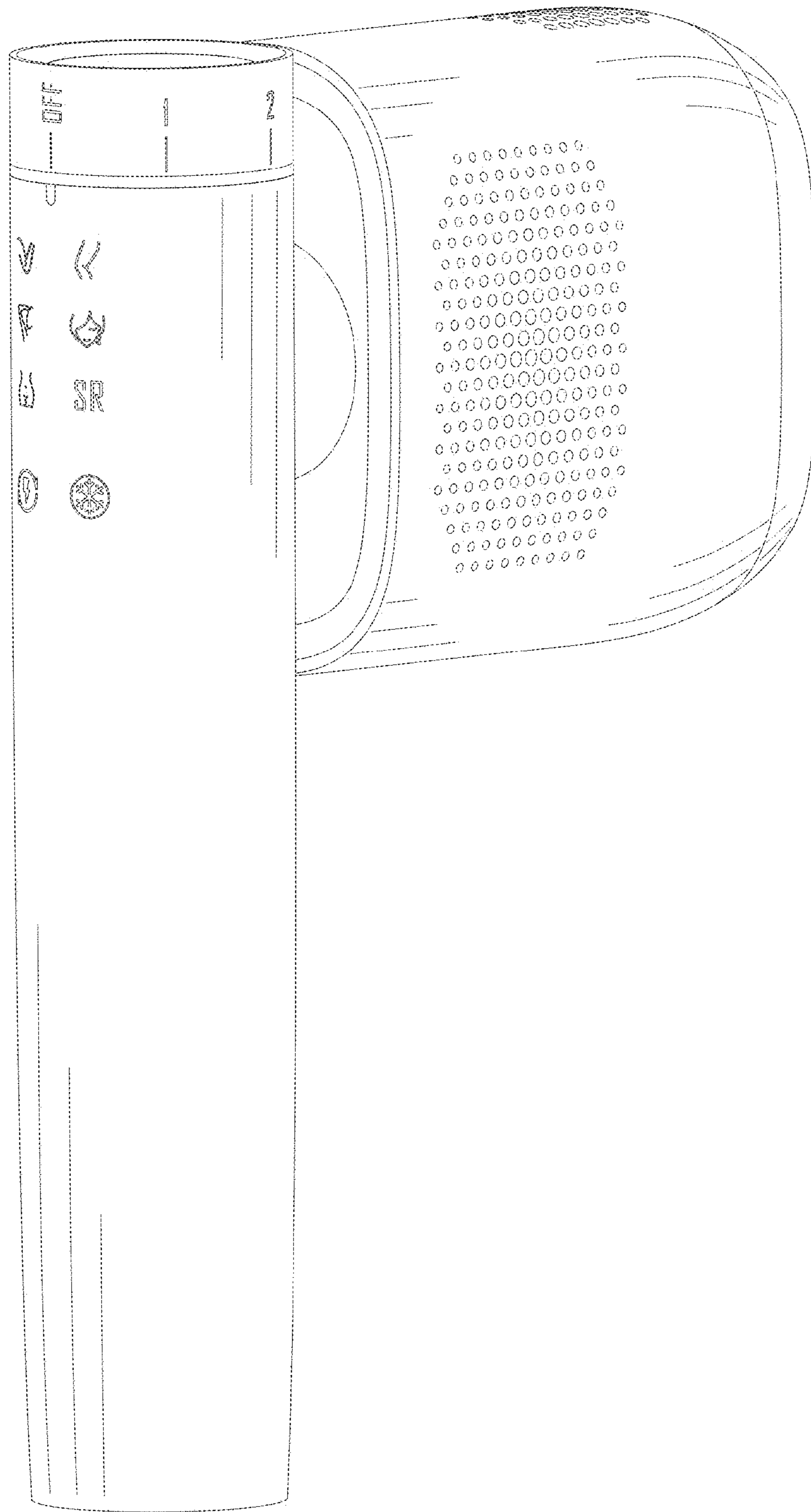

Fig.7

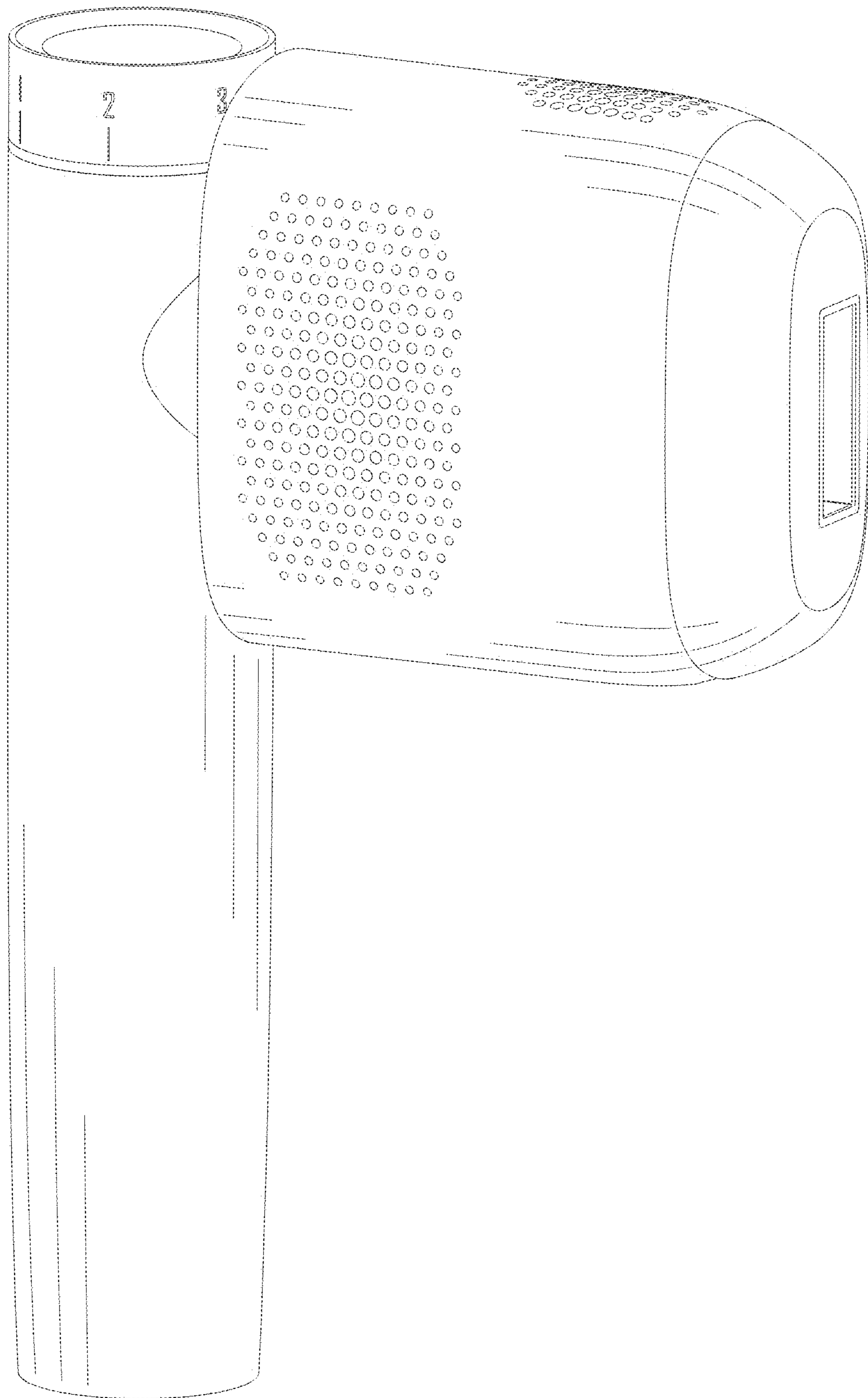

Fig.8

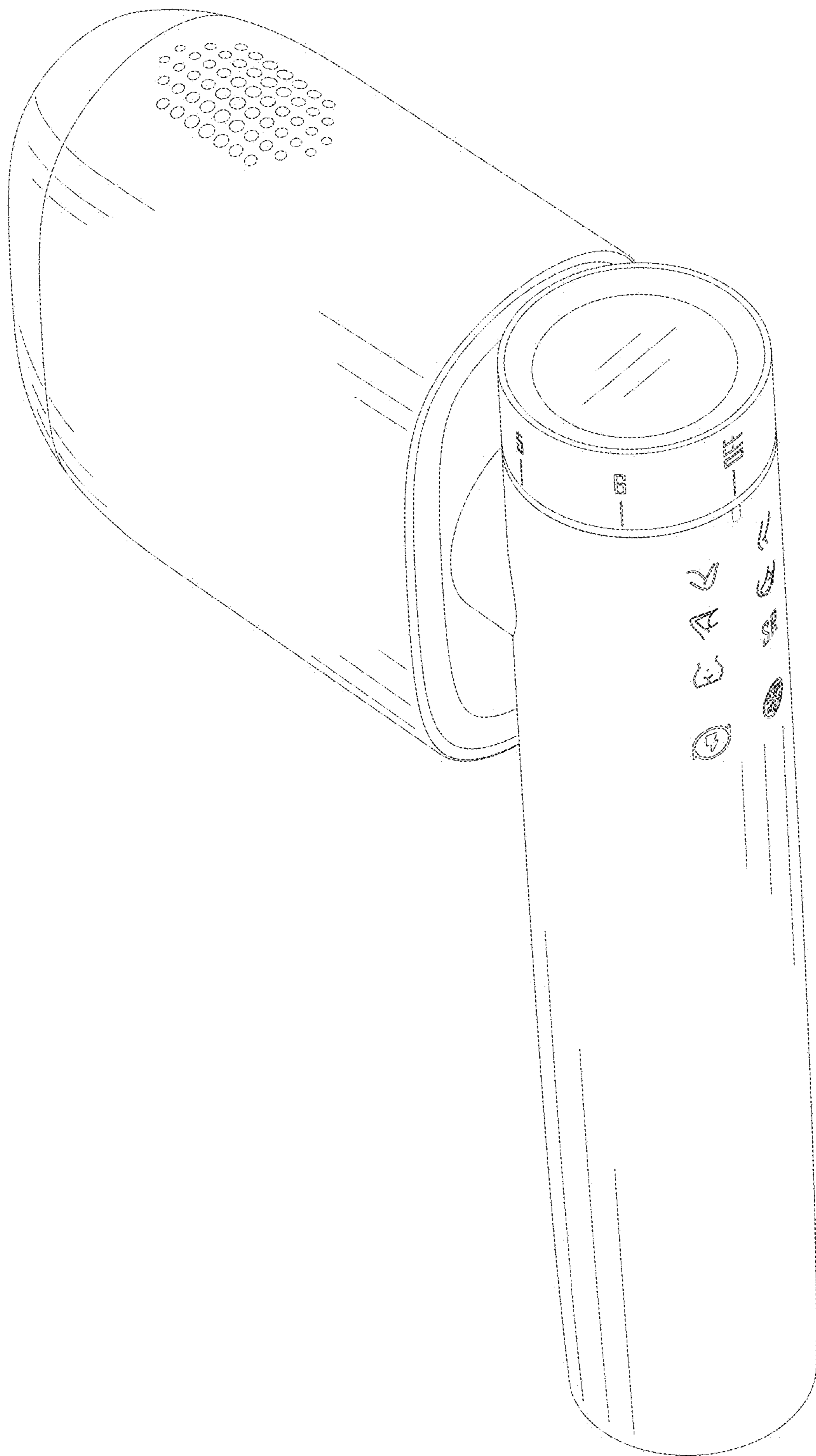

Fig.9

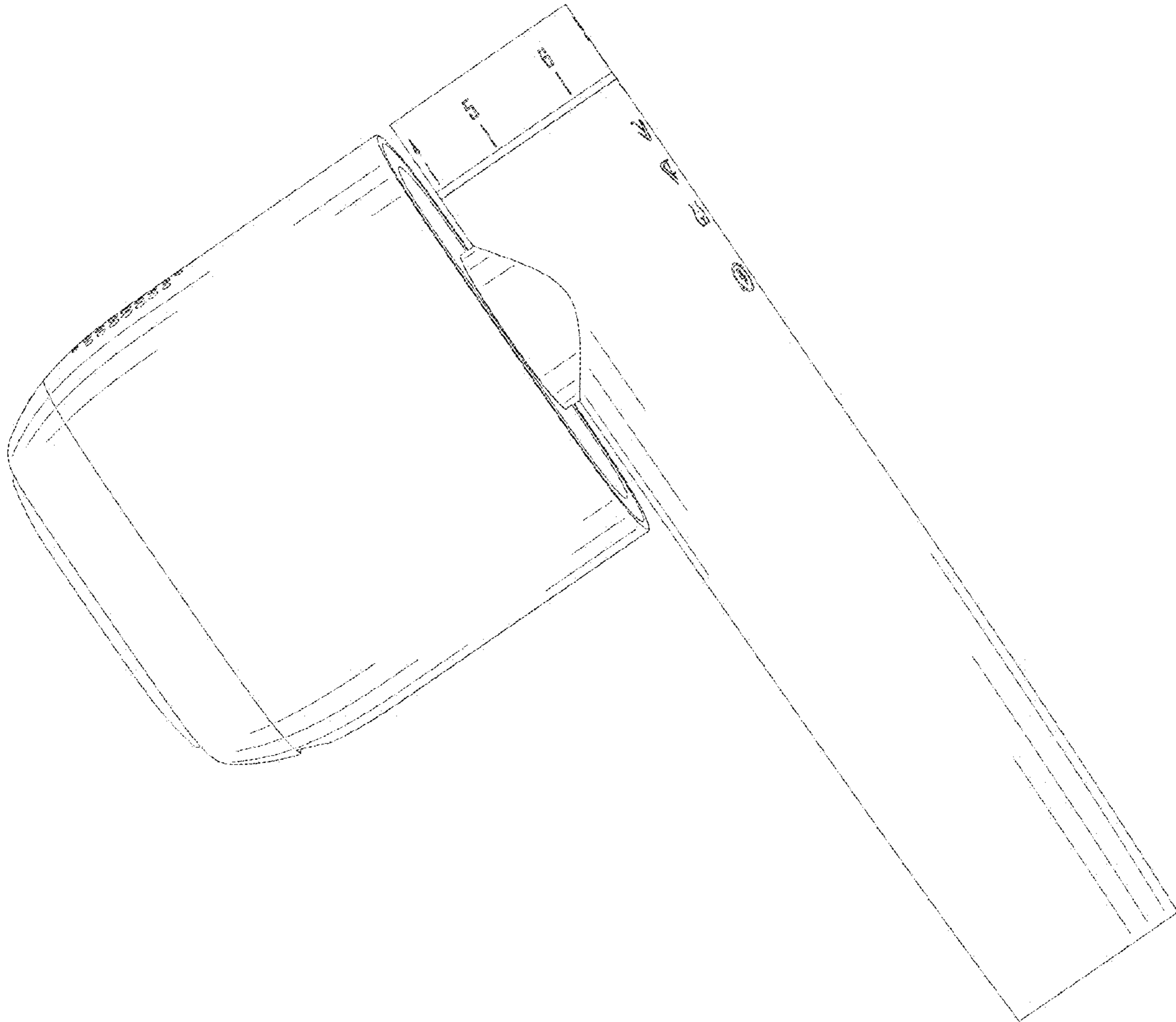

Fig.10