



US00D908915S

(12) **United States Design Patent**
Bagnato et al.

(10) **Patent No.:** **US D908,915 S**
(45) **Date of Patent:** **** Jan. 26, 2021**

(54) **SAMPLE PROCESSING BASKET**

(71) Applicant: **LEICA BIOSYSTEMS**
MELBOURNE PTY LTD, Mount
Waverley (AU)

(72) Inventors: **Stephen John Bagnato**, Mt Waverley
(AU); **Orlando Skeete**, South Yarra
(AU); **Frank Austin**, Mt Waverley
(AU); **Eric Nicolas Baessler**, Eltham
(AU); **Simon Peter Harris**, Wangaratta
(AU)

(73) Assignee: **LEICA BIOSYSTEMS**
MELBOURNE PTY LTD, Mount
Waverly (AU)

(**) Term: **15 Years**

(21) Appl. No.: **29/614,709**

(22) Filed: **Aug. 22, 2017**

(51) **LOC (13) Cl.** **24-02**

(52) **U.S. Cl.**
USPC **D24/227**

(58) **Field of Classification Search**
USPC D24/216, 217, 222–230; D3/203.1, 304,
D3/306, 307, 560, 653; D19/75, 90;
D6/560, 653

(Continued)

(56) **References Cited**

U.S. PATENT DOCUMENTS

3,604,566 A * 9/1971 Rem B01L 9/06
211/74

D360,697 S * 7/1995 Riihimaki D24/217
(Continued)

Primary Examiner — Susan Bennett Hattan

Assistant Examiner — Omeed Agilee

(74) *Attorney, Agent, or Firm* — Sughrue Mion, PLLC

(57) **CLAIM**

The ornamental design for a sample processing basket, as shown and described.

DESCRIPTION

FIG. 1 is an isometric view from a top of a sample processing basket with a retractable handle showing our new design;

FIG. 2 is an isometric view from a bottom thereof;

FIG. 3 is a front elevational view thereof;

FIG. 4 is a side elevational view thereof;

FIG. 5 is a rear elevational view thereof;

FIG. 6 is a top plan view thereof;

FIG. 7 is a bottom plan view thereof;

FIG. 8 is an isometric view from the top thereof with the handle extended;

FIG. 9 is an isometric view from the bottom thereof with the handle extended;

FIG. 10 is a front elevational view thereof with the handle extended;

FIG. 11 is a side elevational view thereof with the handle extended;

FIG. 12 is a rear elevational view thereof with the handle extended;

FIG. 13 is an isometric view from the top thereof with the lid removed;

FIG. 14 is an isometric view from the bottom thereof with the lid removed;

FIG. 15 is a front elevational view thereof with the lid removed;

FIG. 16 is a side elevational view thereof with the lid removed;

FIG. 17 is a rear elevational view thereof with the lid removed;

FIG. 18 is a top plan view thereof with the lid removed;

FIG. 19 is a bottom plan view thereof with the lid removed;

FIG. 20 is an isometric view from the top thereof with the handle extended and lid removed;

FIG. 21 is an isometric view from the bottom thereof with the handle extended and lid removed;

FIG. 22 is a front elevational view thereof with the handle extended and lid removed;

(Continued)

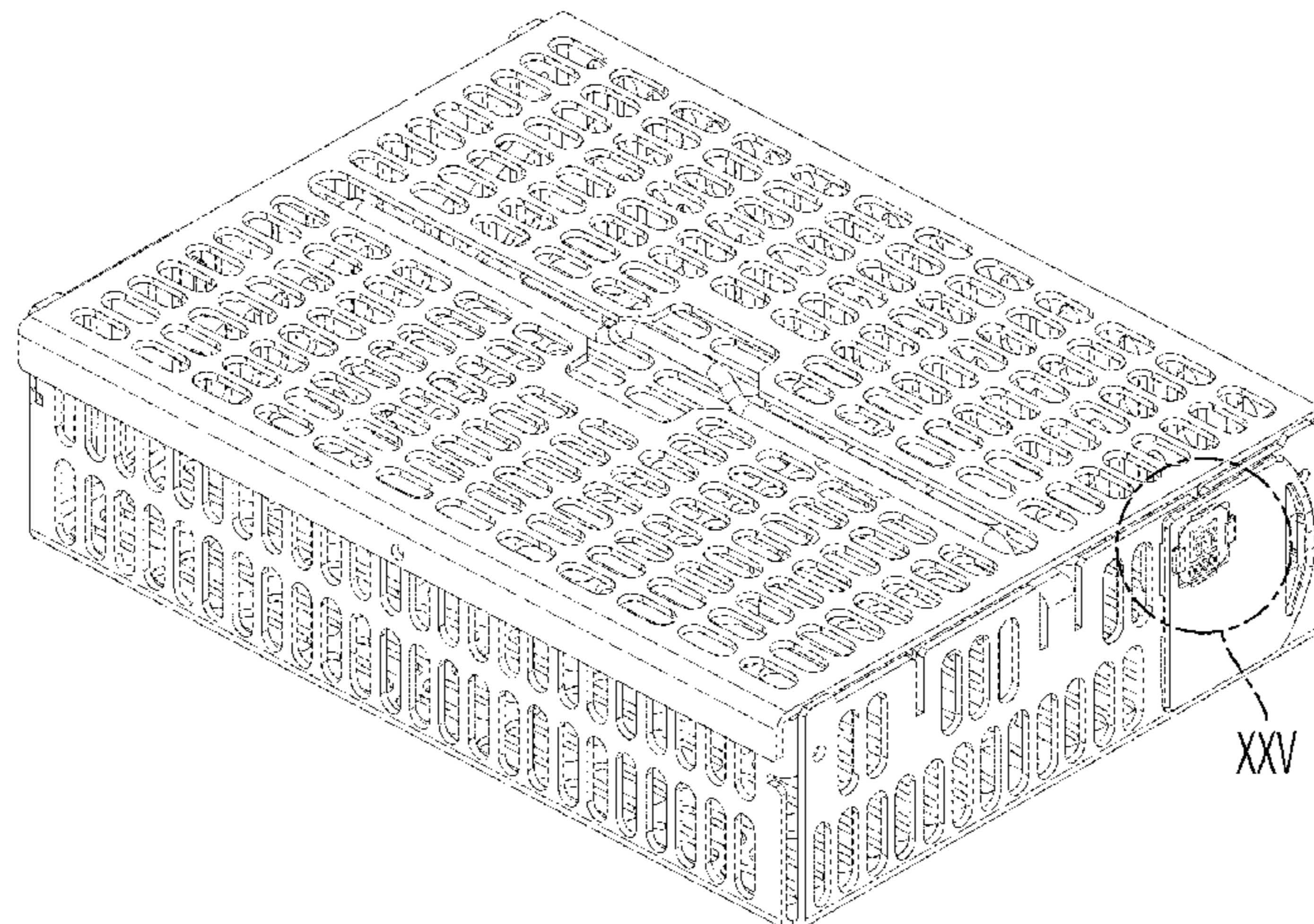

FIG. 23 is a side elevational view thereof with the handle extended and lid removed; and

FIG. 24 is a rear elevational view thereof with the handle extended and lid removed.

FIG. 25 is an enlarged isometric view of the portion XXV shown in FIG. 1

FIG. 26 is an enlarged bottom isometric view of the portion XXVI shown in FIG. 2; and,

FIG. 27 is an enlarged front elevational view of the portion XXVII shown in FIG. 3.

1 Claim, 27 Drawing Sheets

(58) Field of Classification Search

CPC B01L 9/00; B01L 9/06; B01L 7/52; G01N
25/486

See application file for complete search history.

(56) References Cited

U.S. PATENT DOCUMENTS

D400,711 S *	11/1998	Hwang	D3/307
6,116,452 A *	9/2000	Hamel	A61L 2/26 206/370
D463,863 S *	10/2002	Carlson	D24/216
D624,660 S *	9/2010	Himmelsbach	D24/230
D699,859 S *	2/2014	Motadel	D24/227
D712,566 S *	9/2014	Hicks	D24/227
D724,236 S *	3/2015	Motadel	D24/227
D735,881 S *	8/2015	Thomas	D24/227
D808,540 S *	1/2018	Johns	D24/227
D812,243 S *	3/2018	Johns	D24/227
D832,454 S *	10/2018	Livingston	D24/224

* cited by examiner

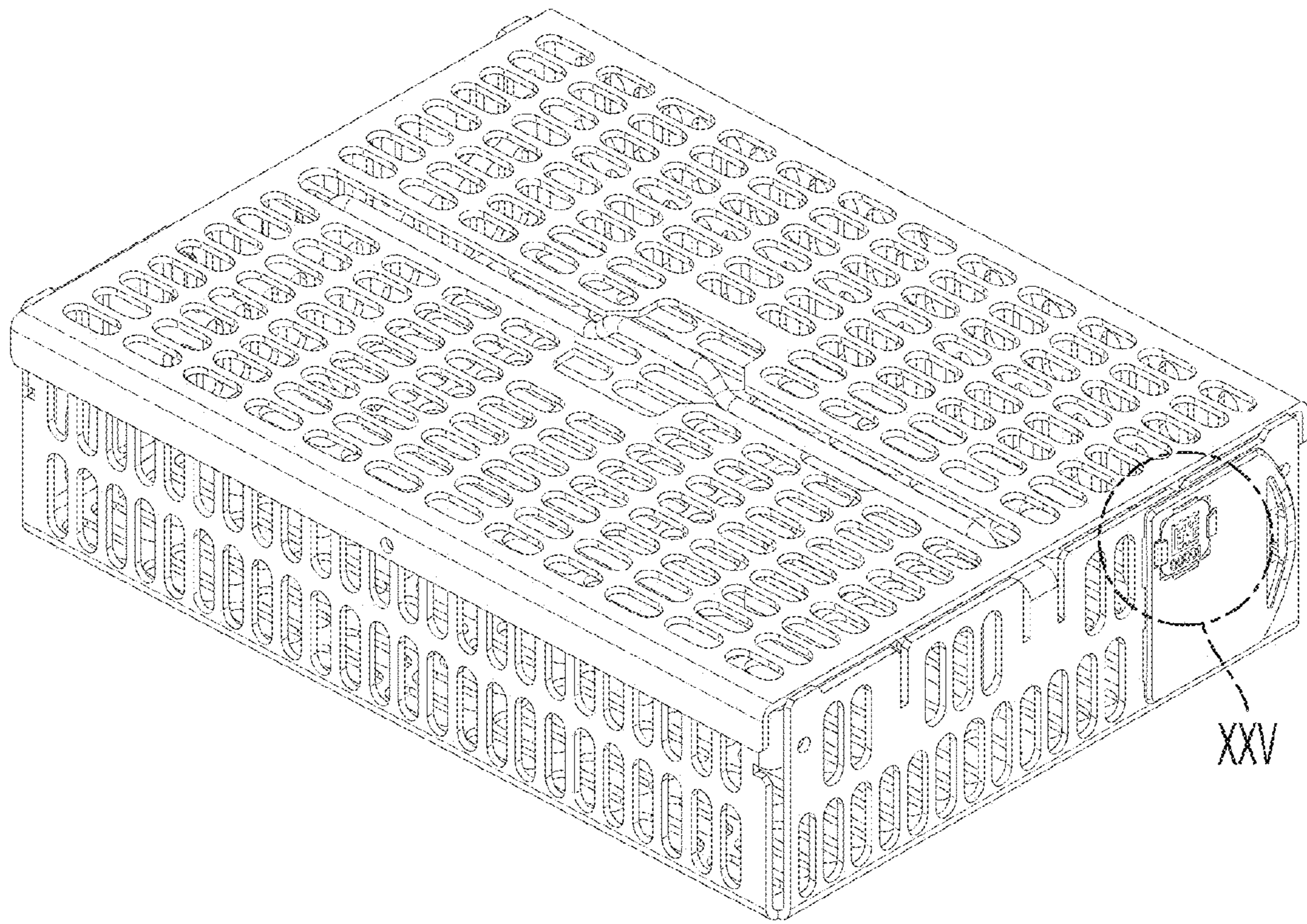

FIG. 1

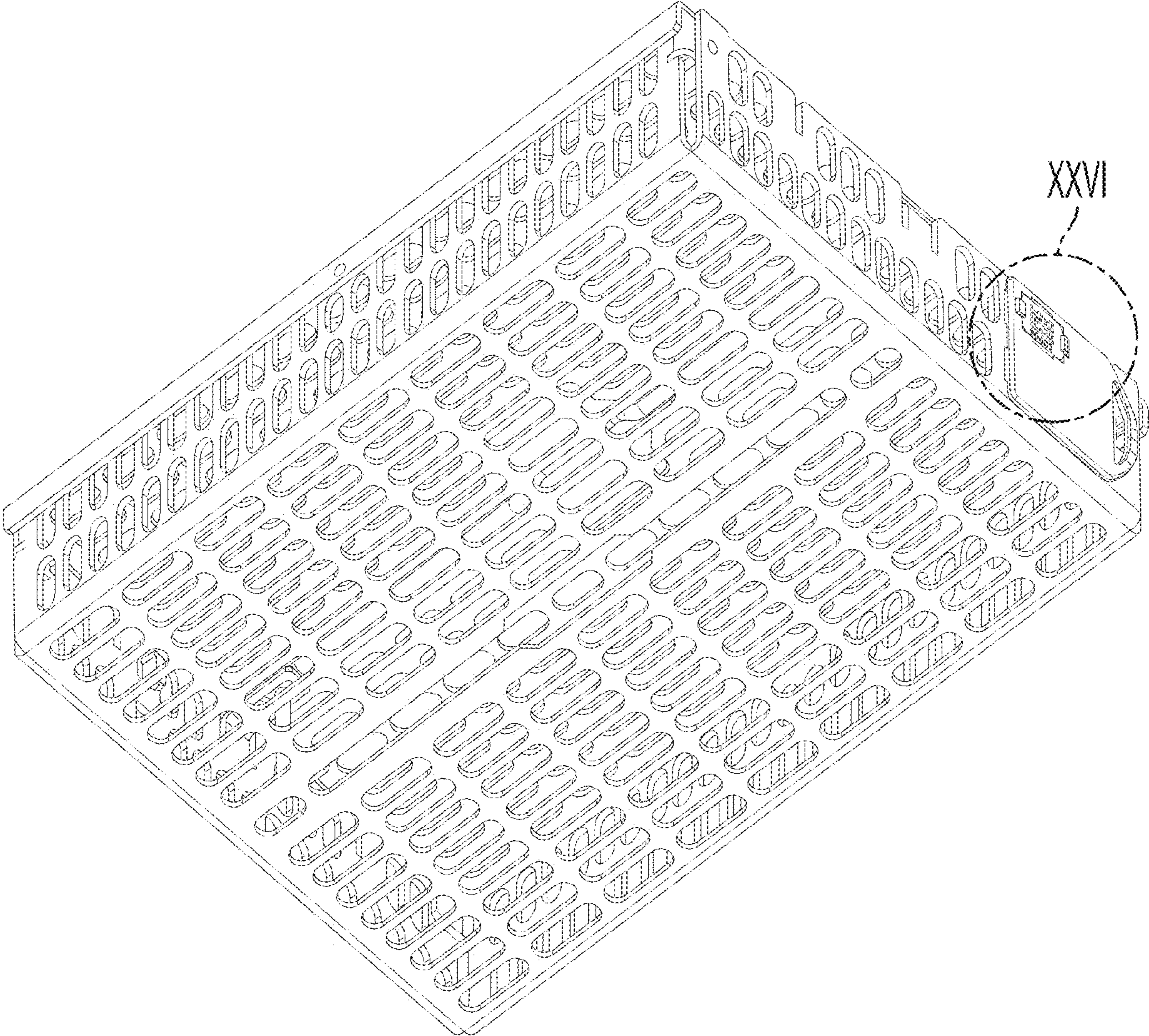

FIG. 2

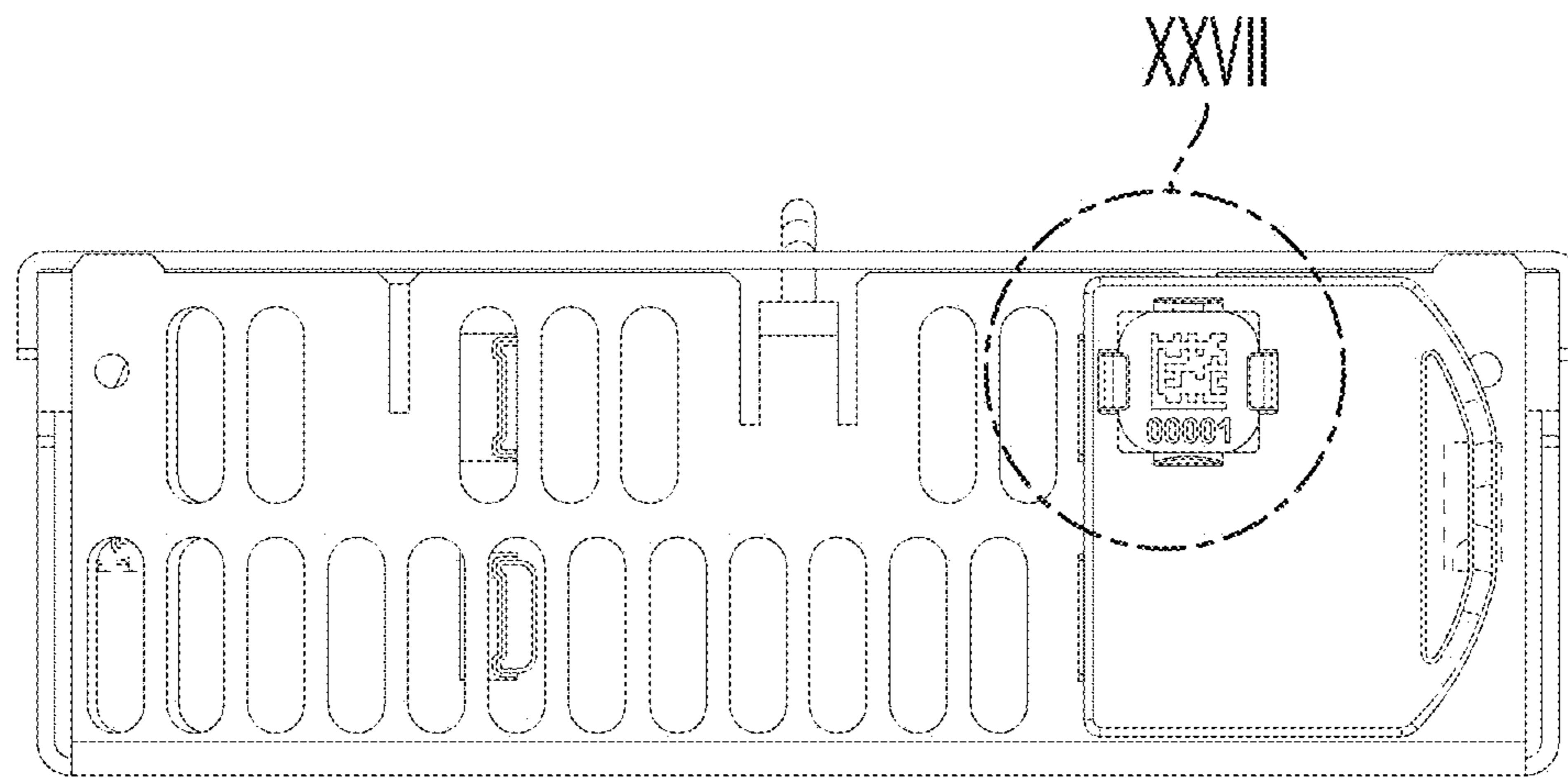

FIG. 3

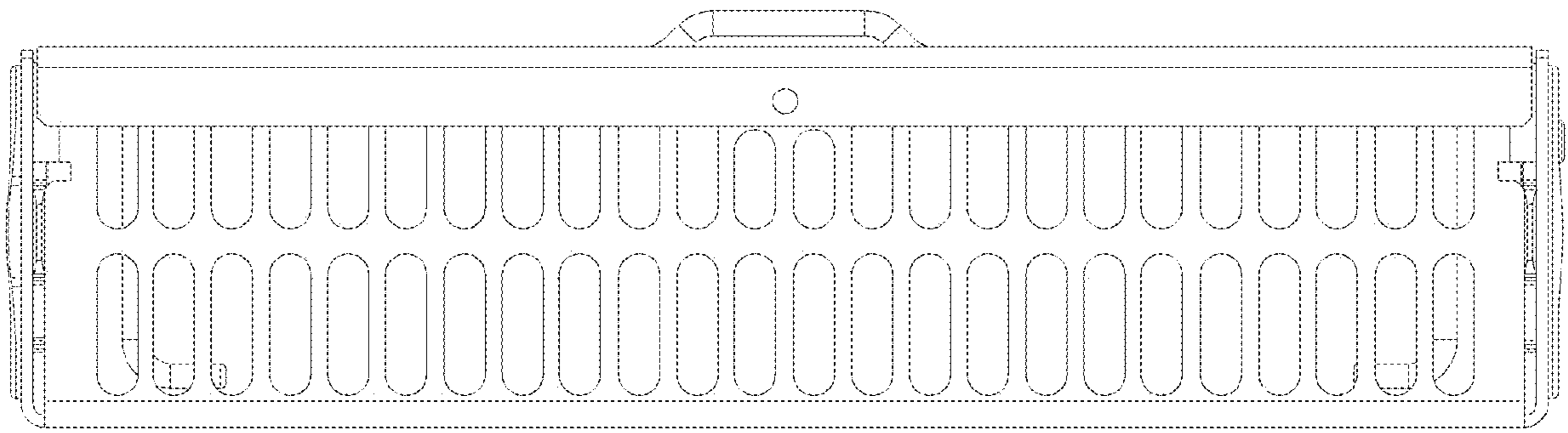

FIG. 4

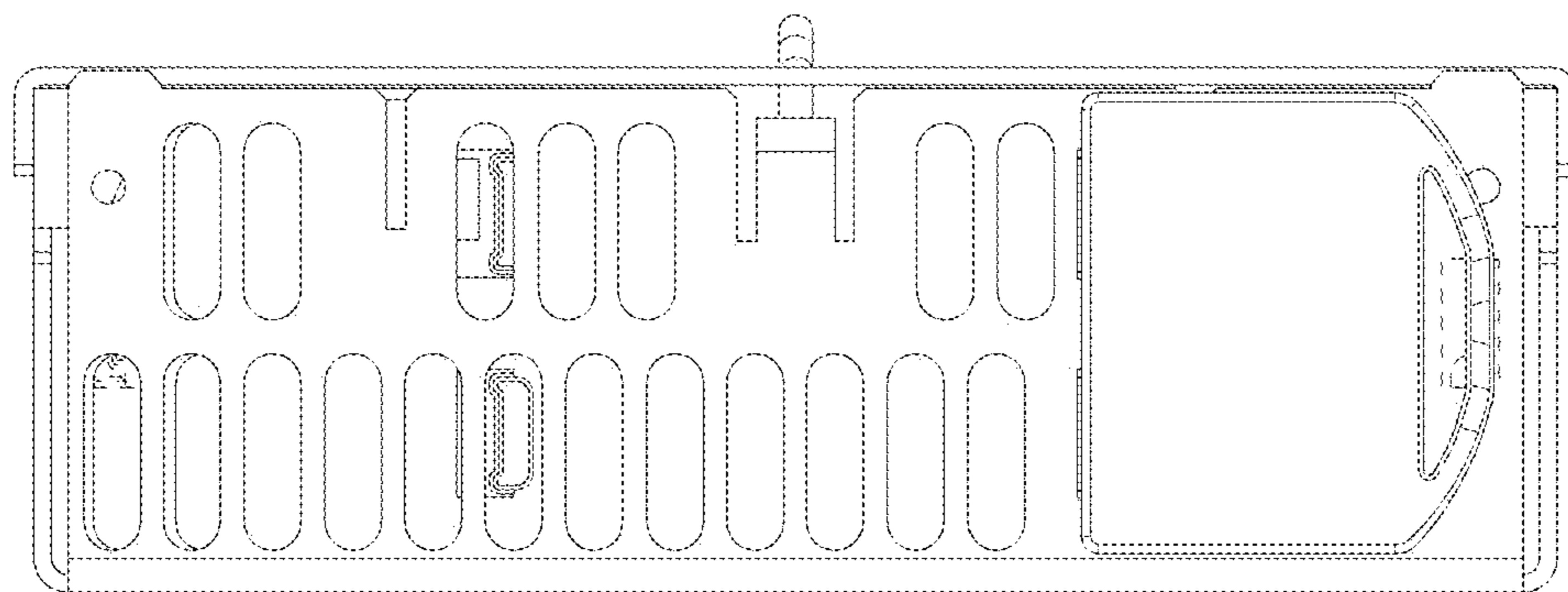

FIG. 5

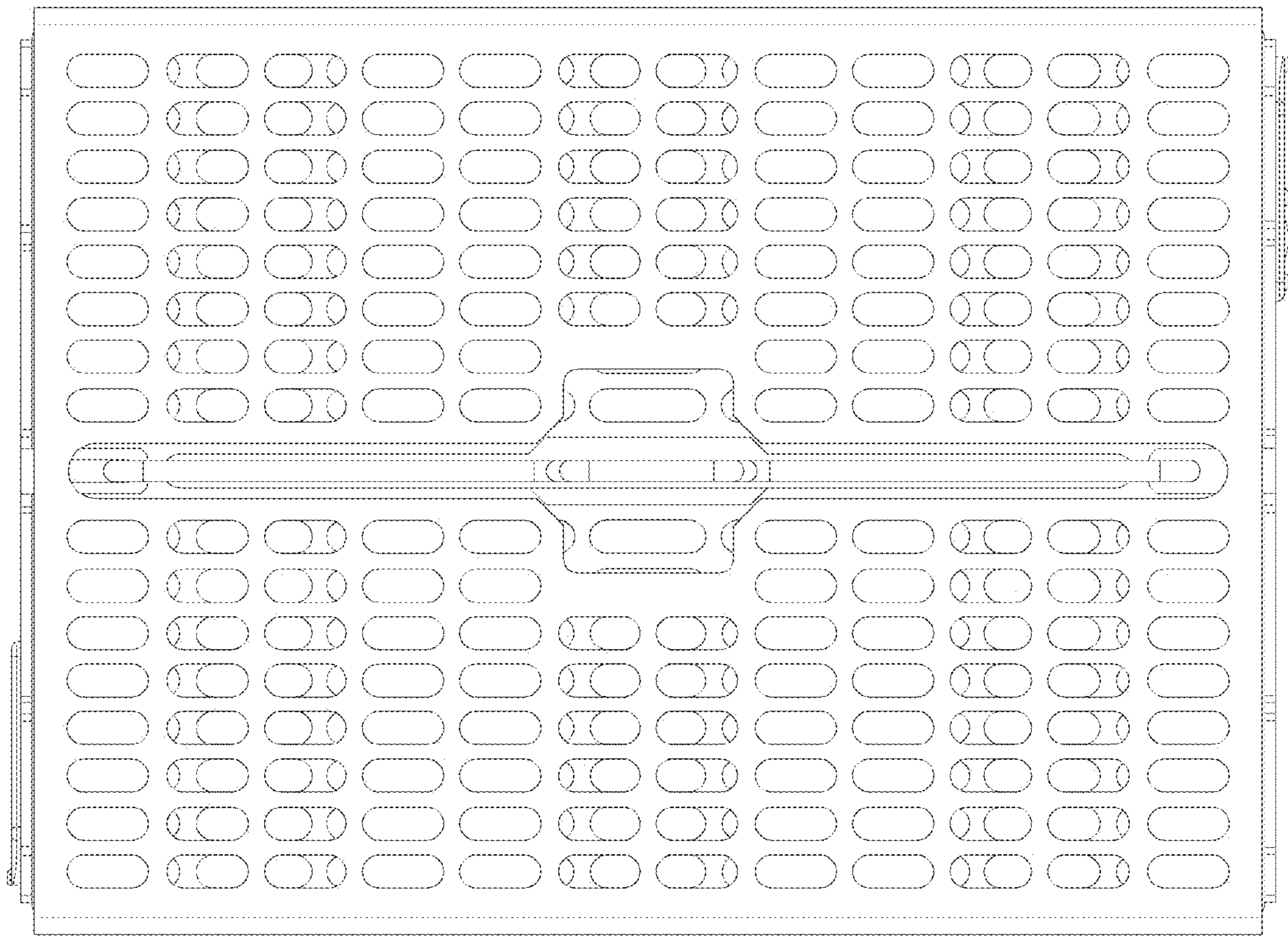

FIG. 6

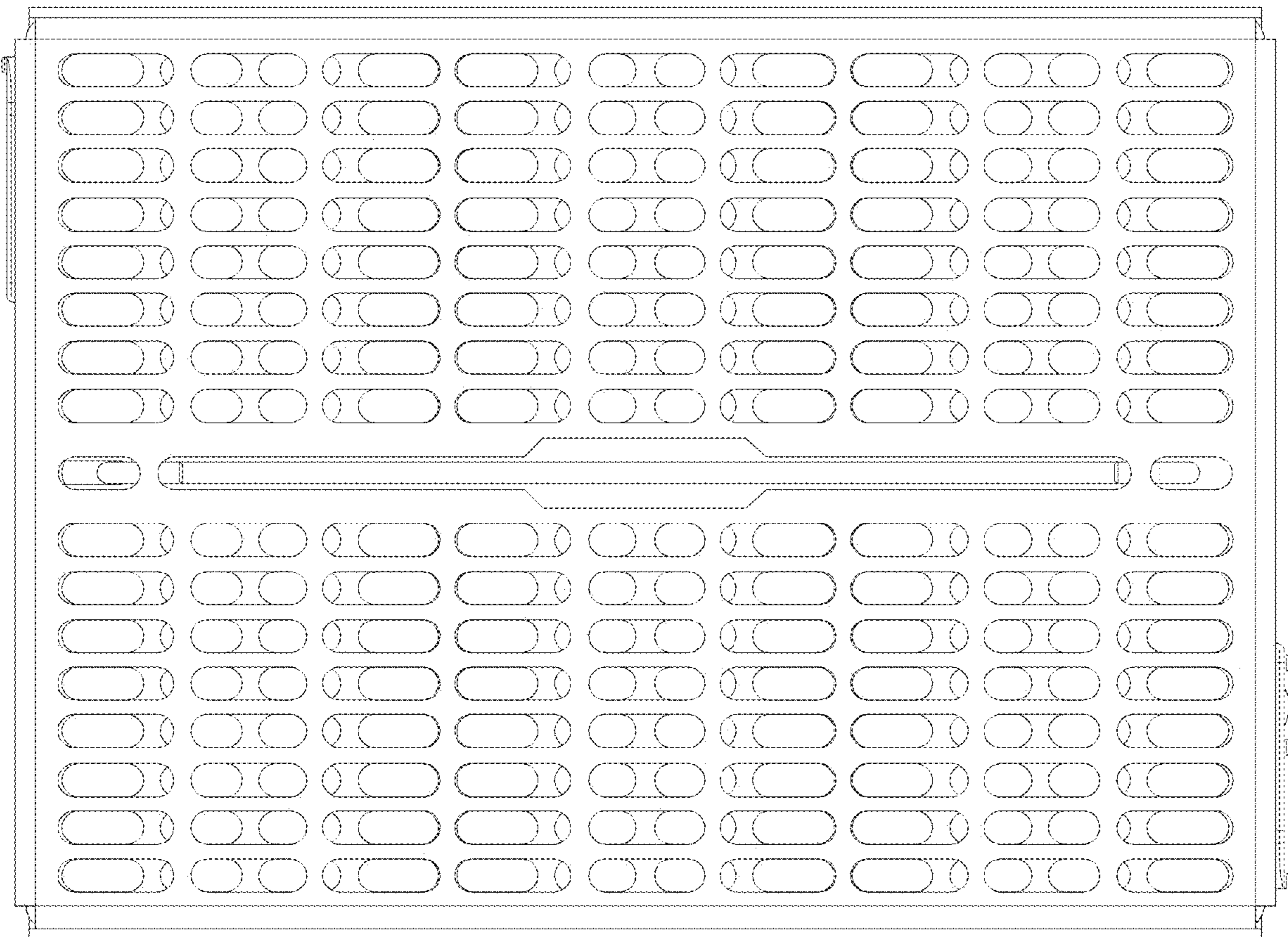

FIG. 7

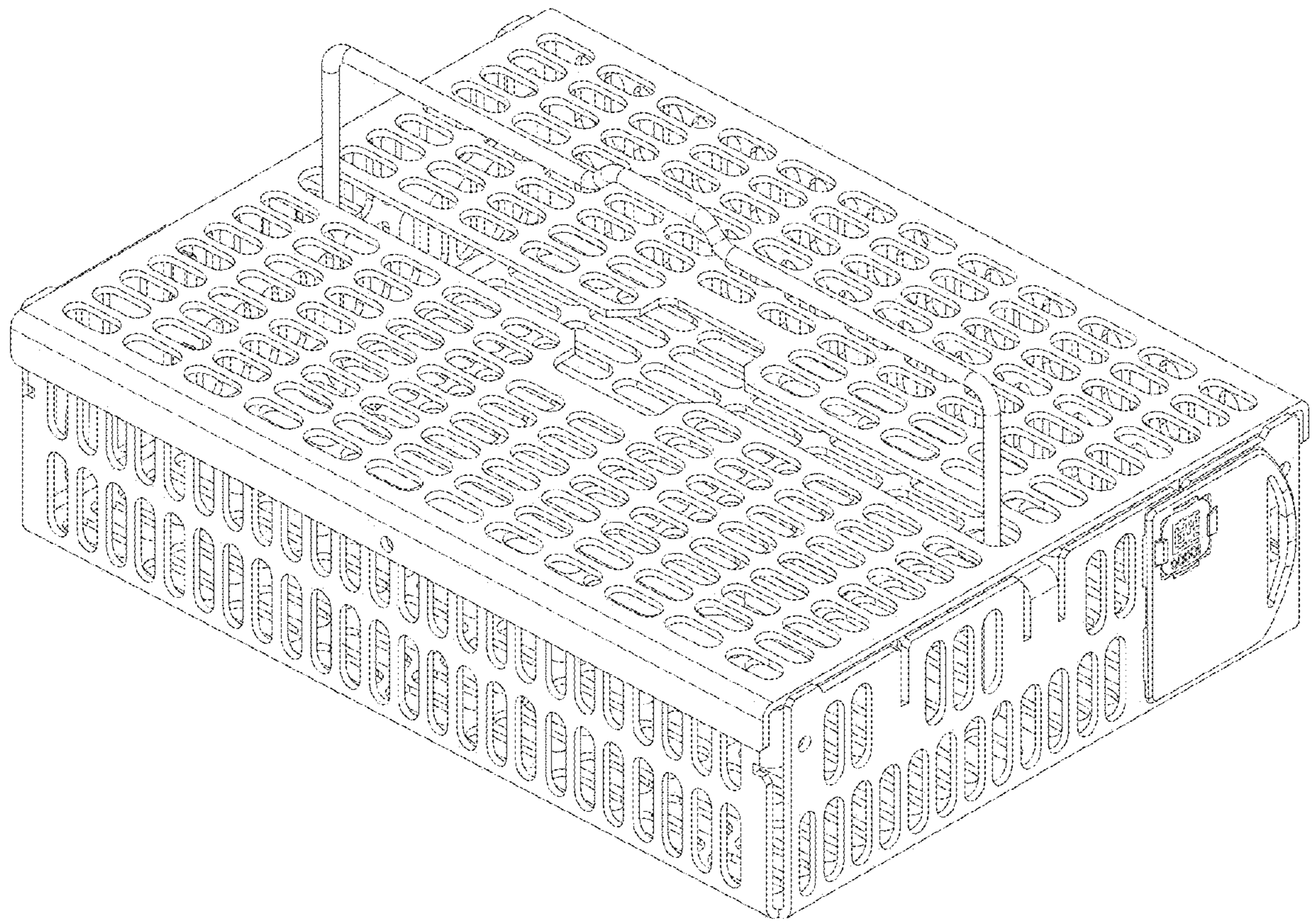

FIG. 8

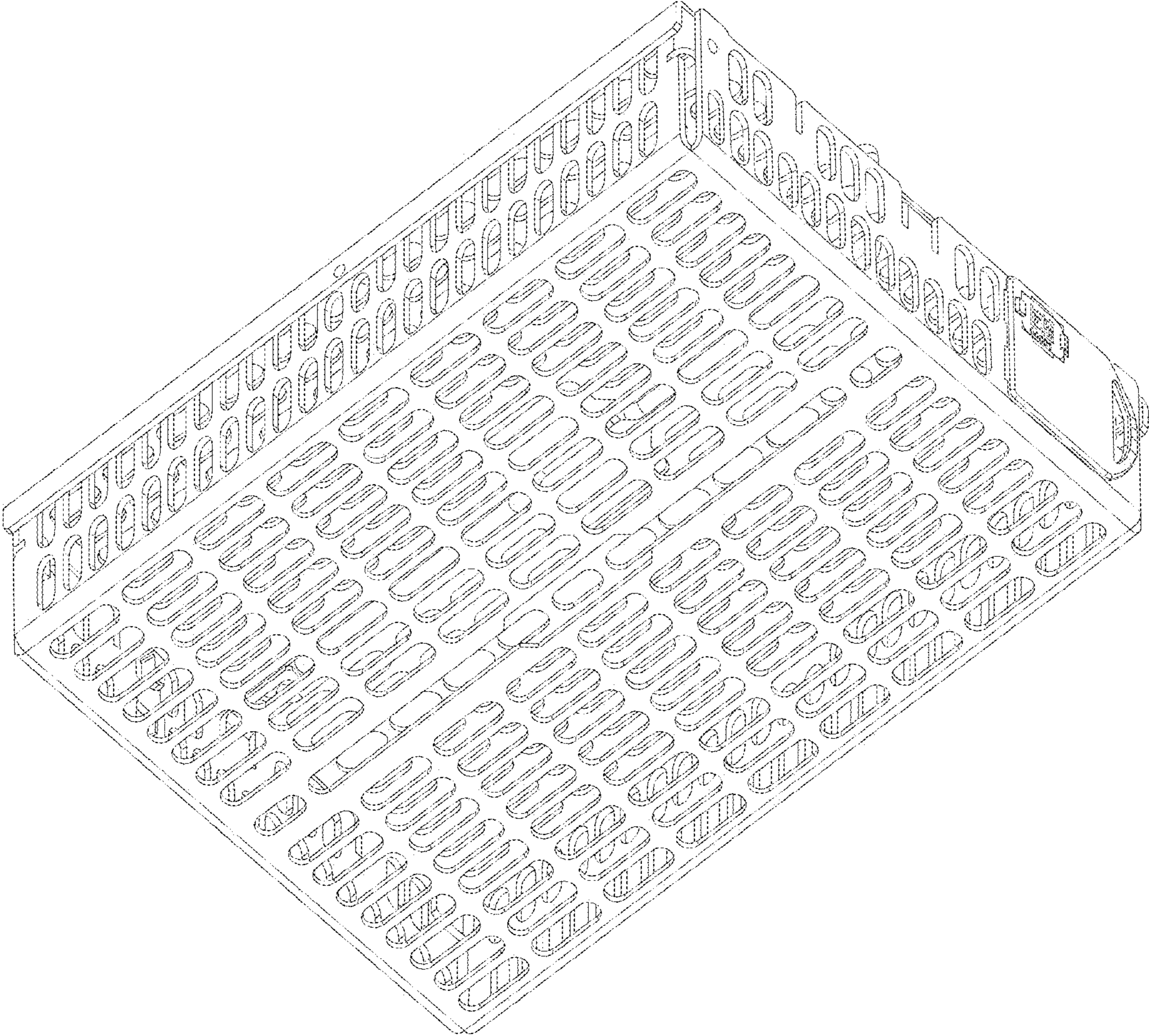

FIG. 9

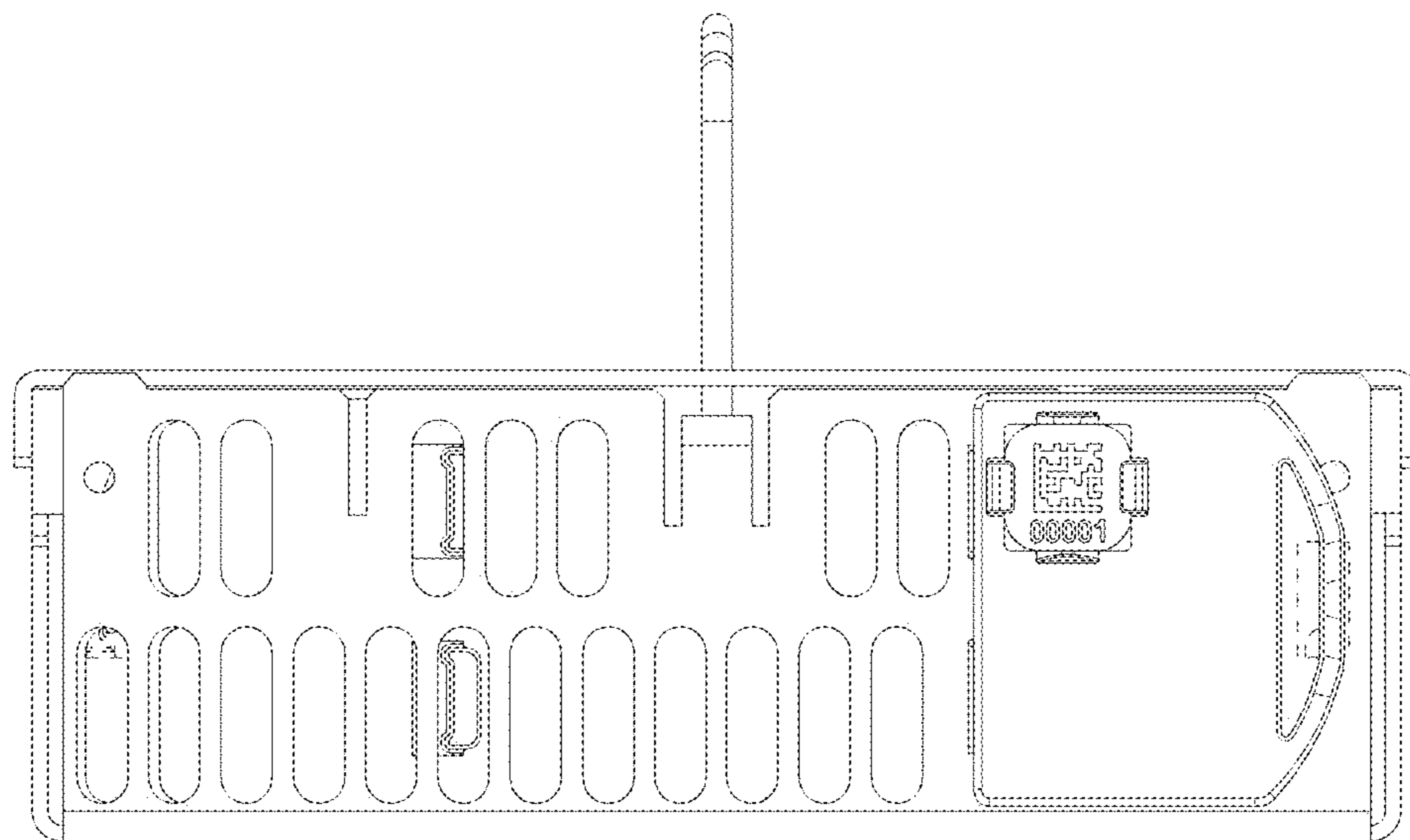

FIG. 10

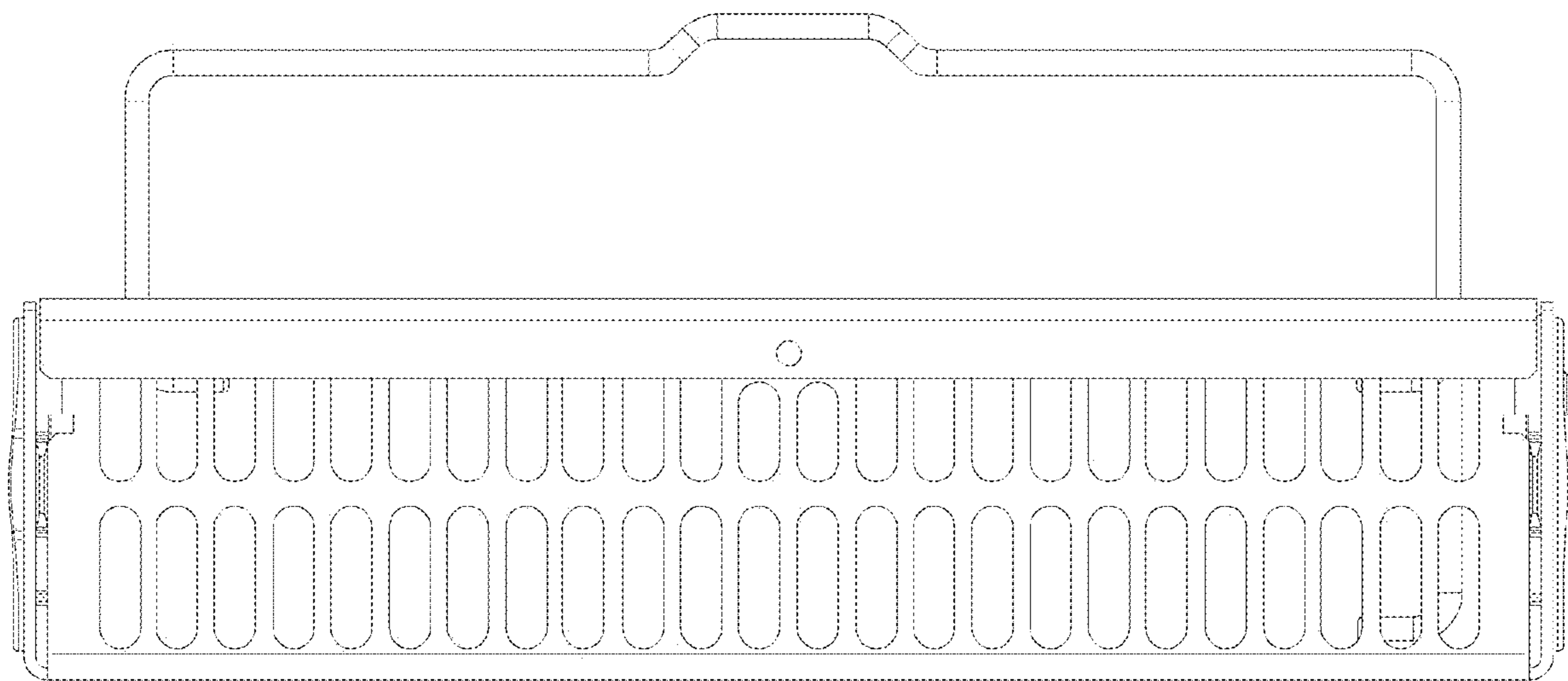

FIG. 11

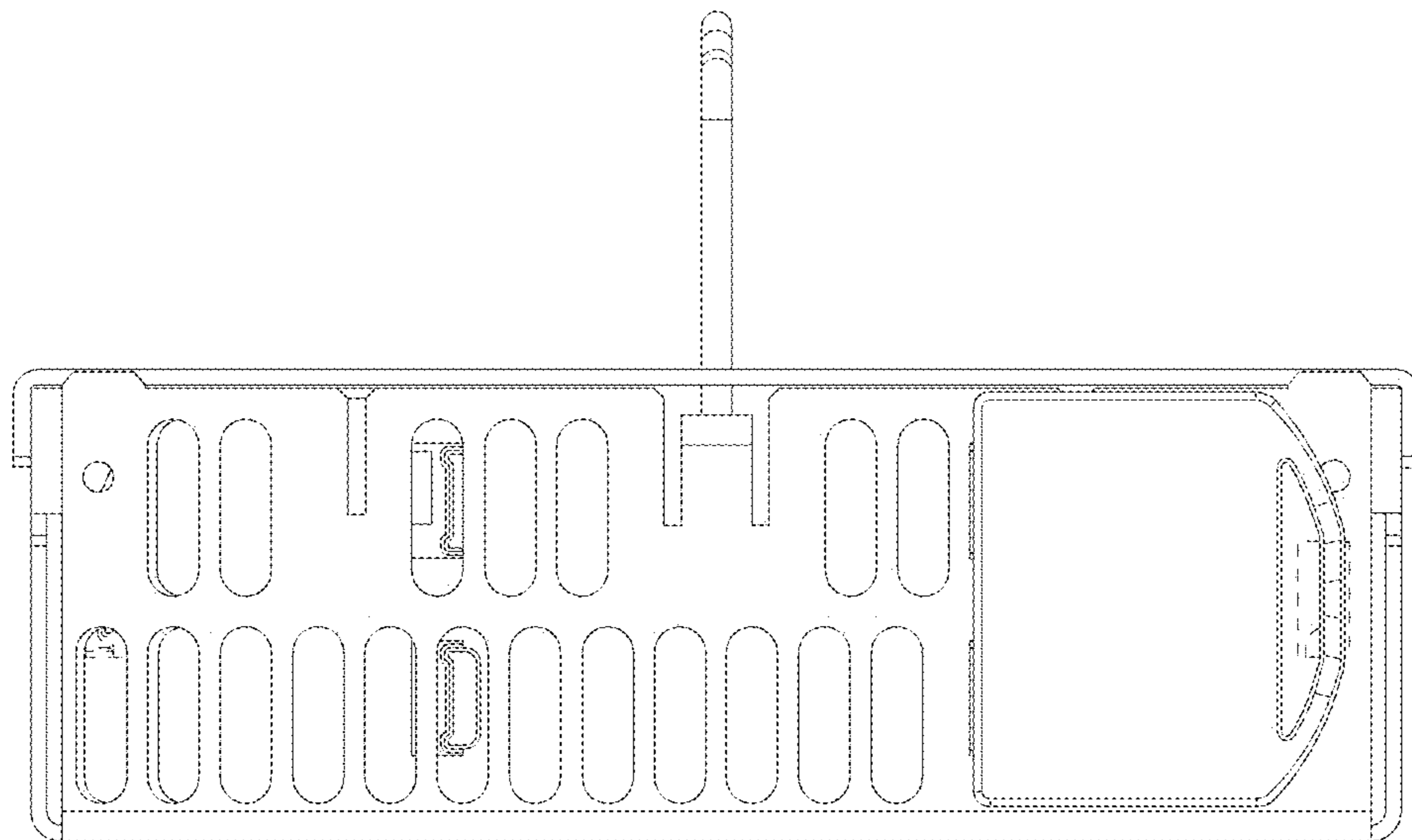

FIG. 12

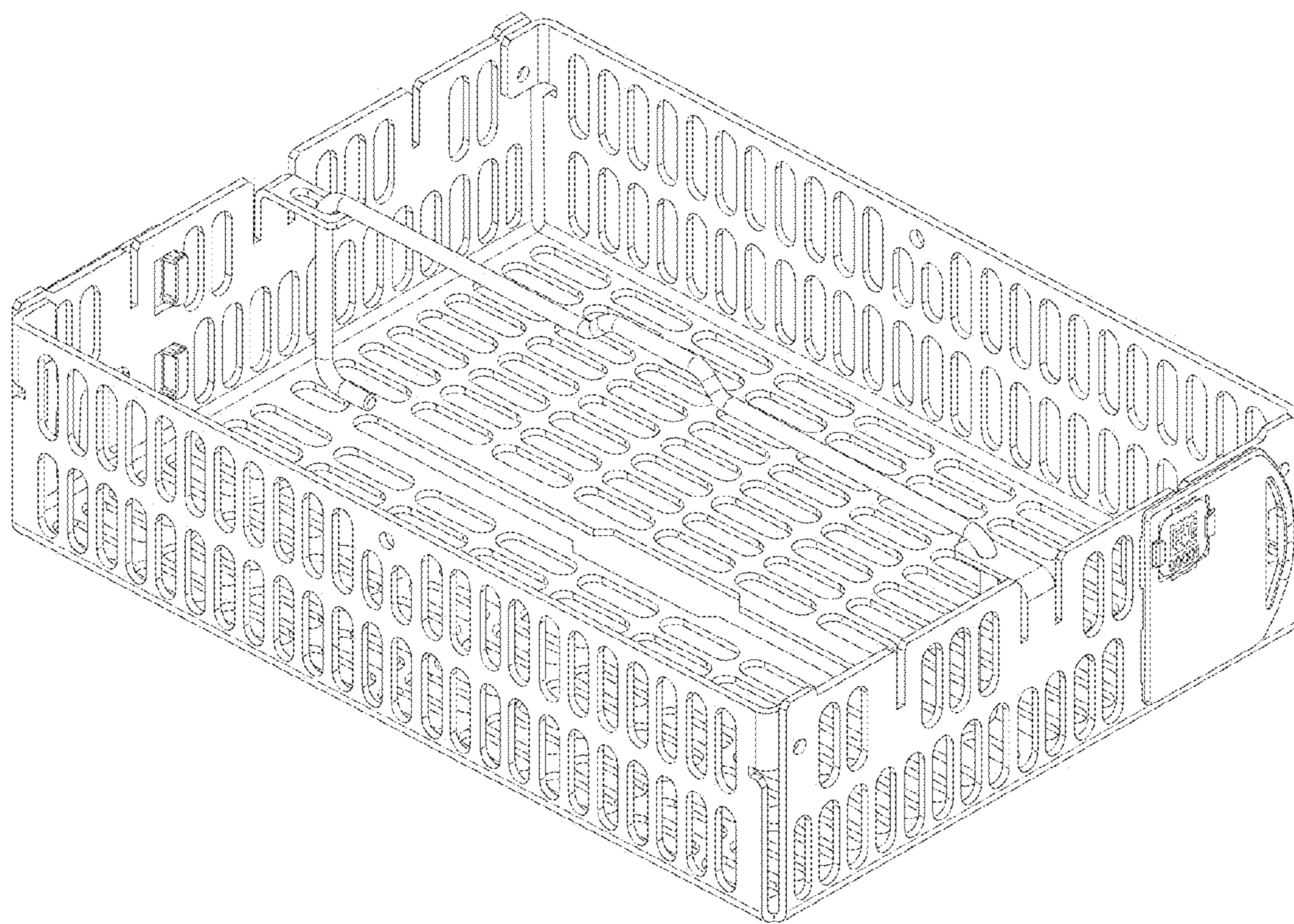

FIG. 13

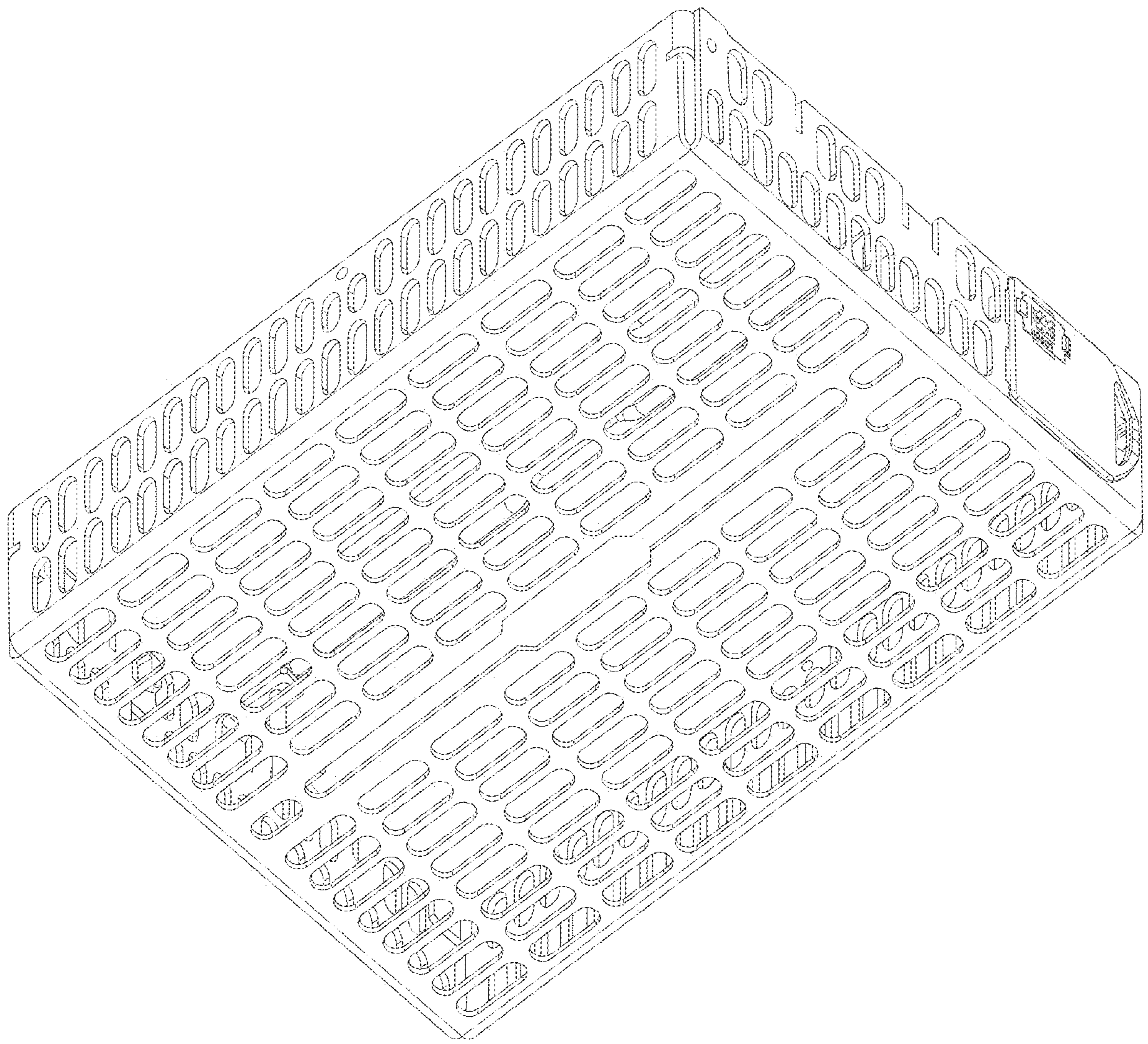

FIG. 14

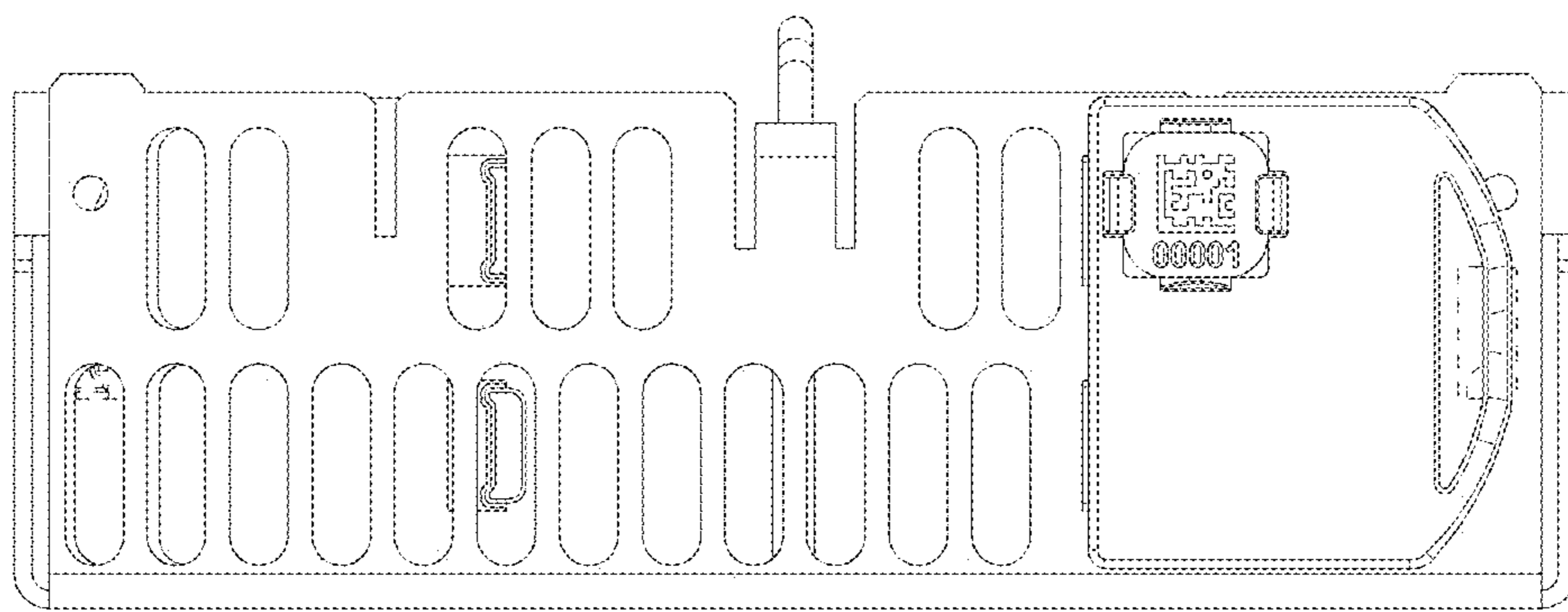

FIG. 15

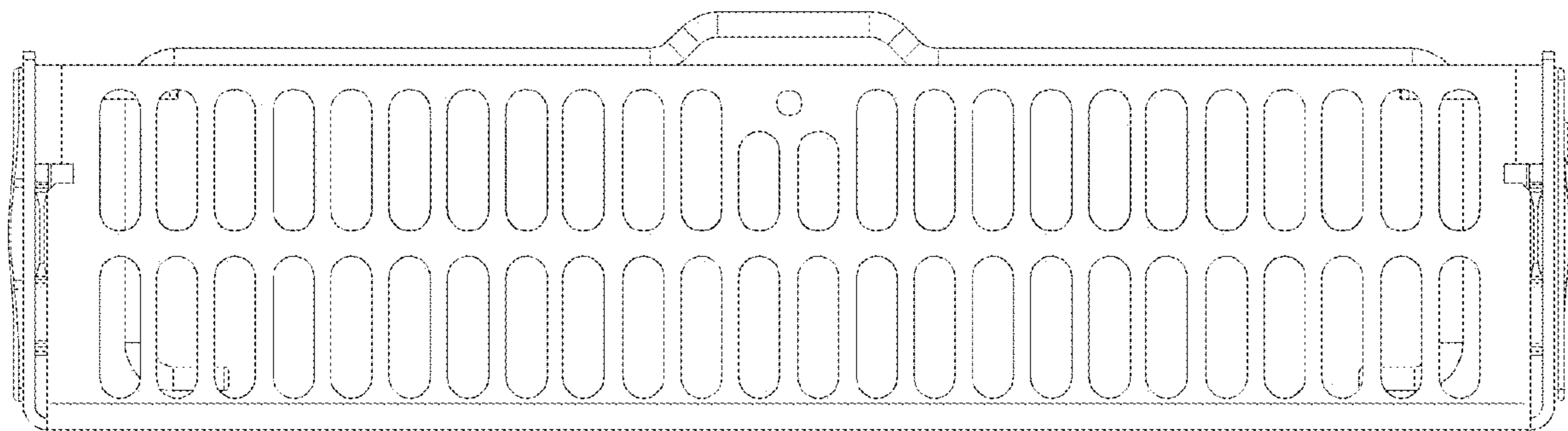

FIG. 16

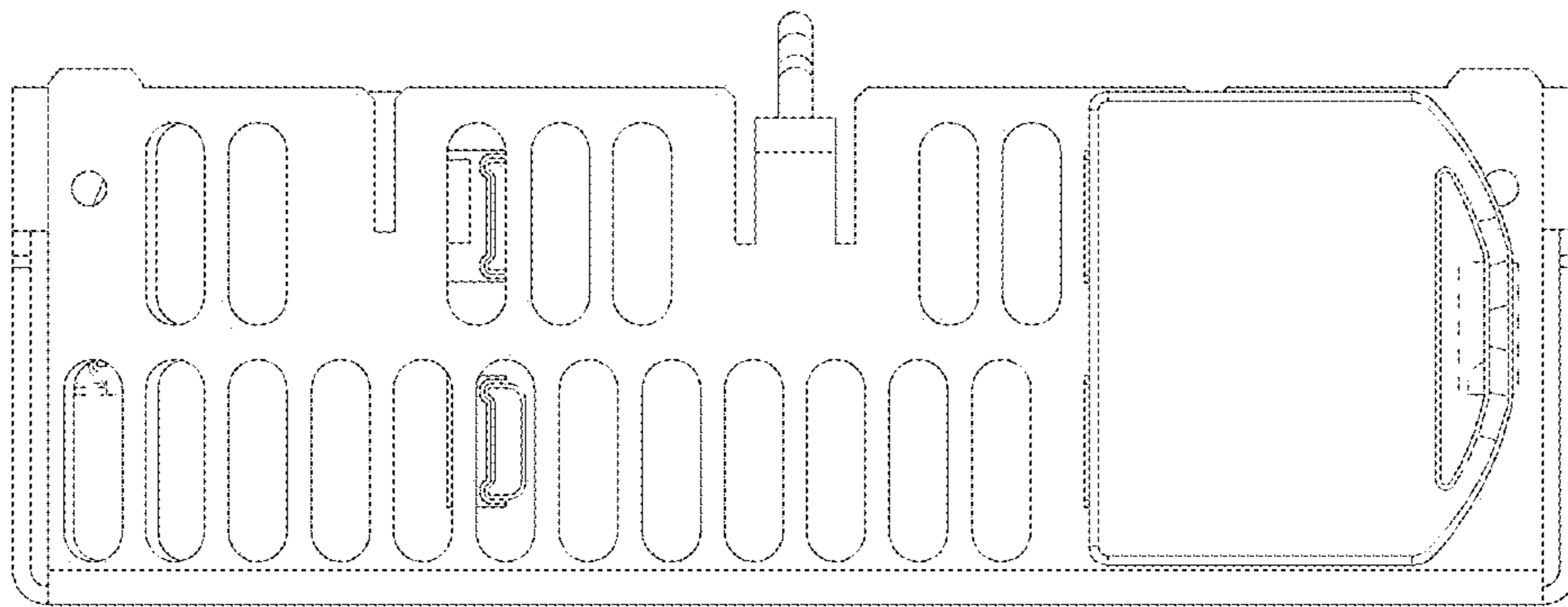

FIG. 17

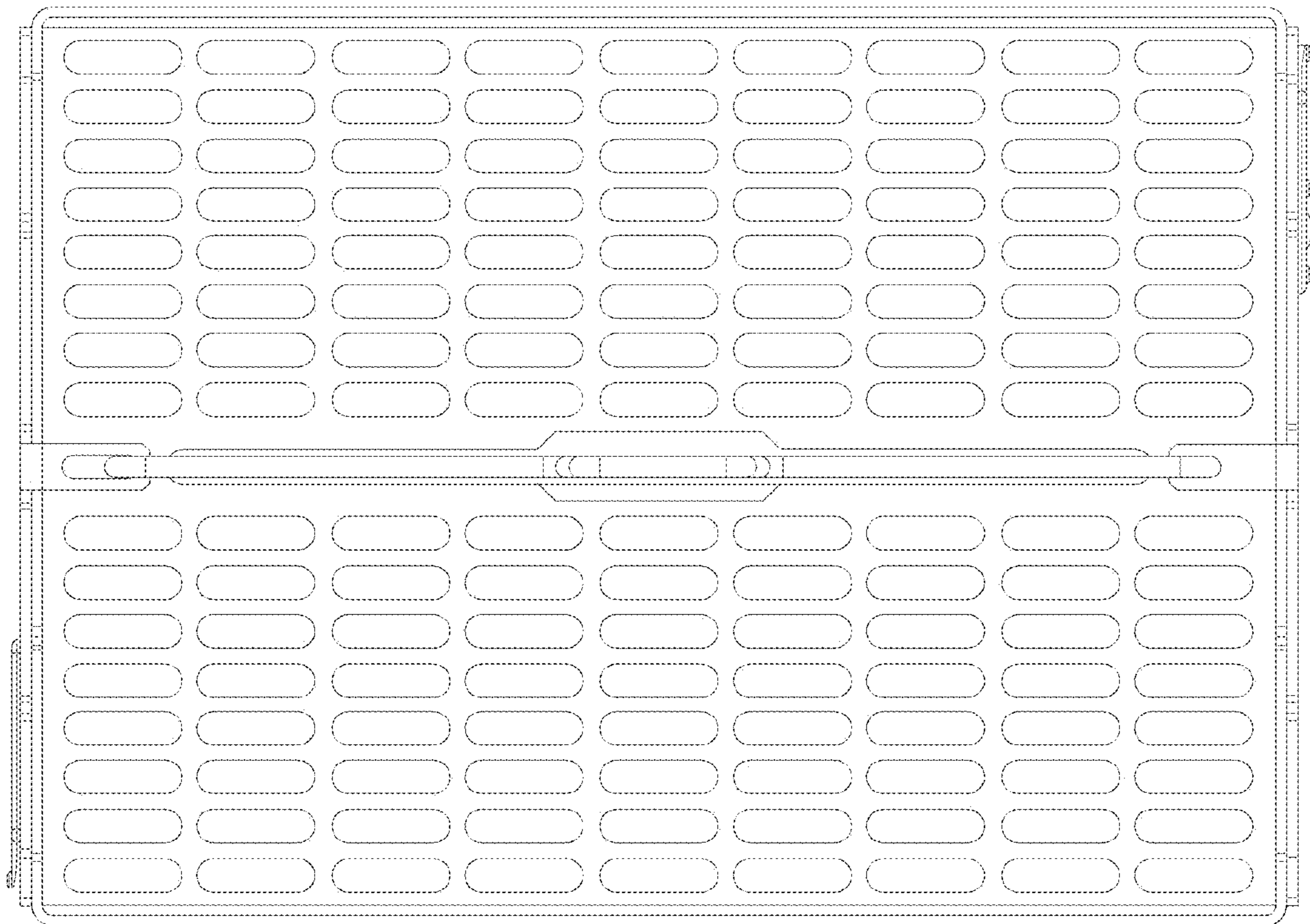

FIG. 18

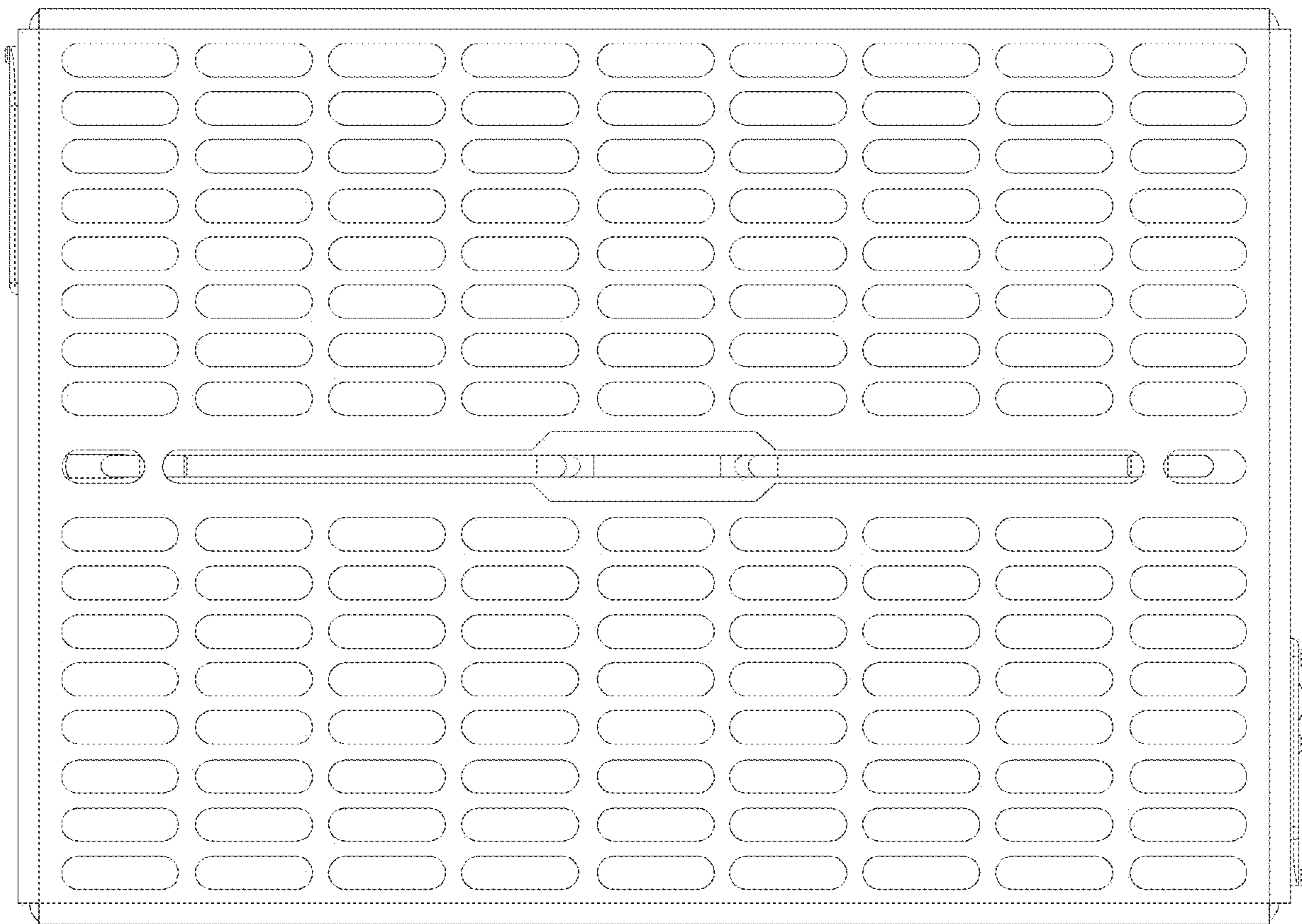

FIG. 19

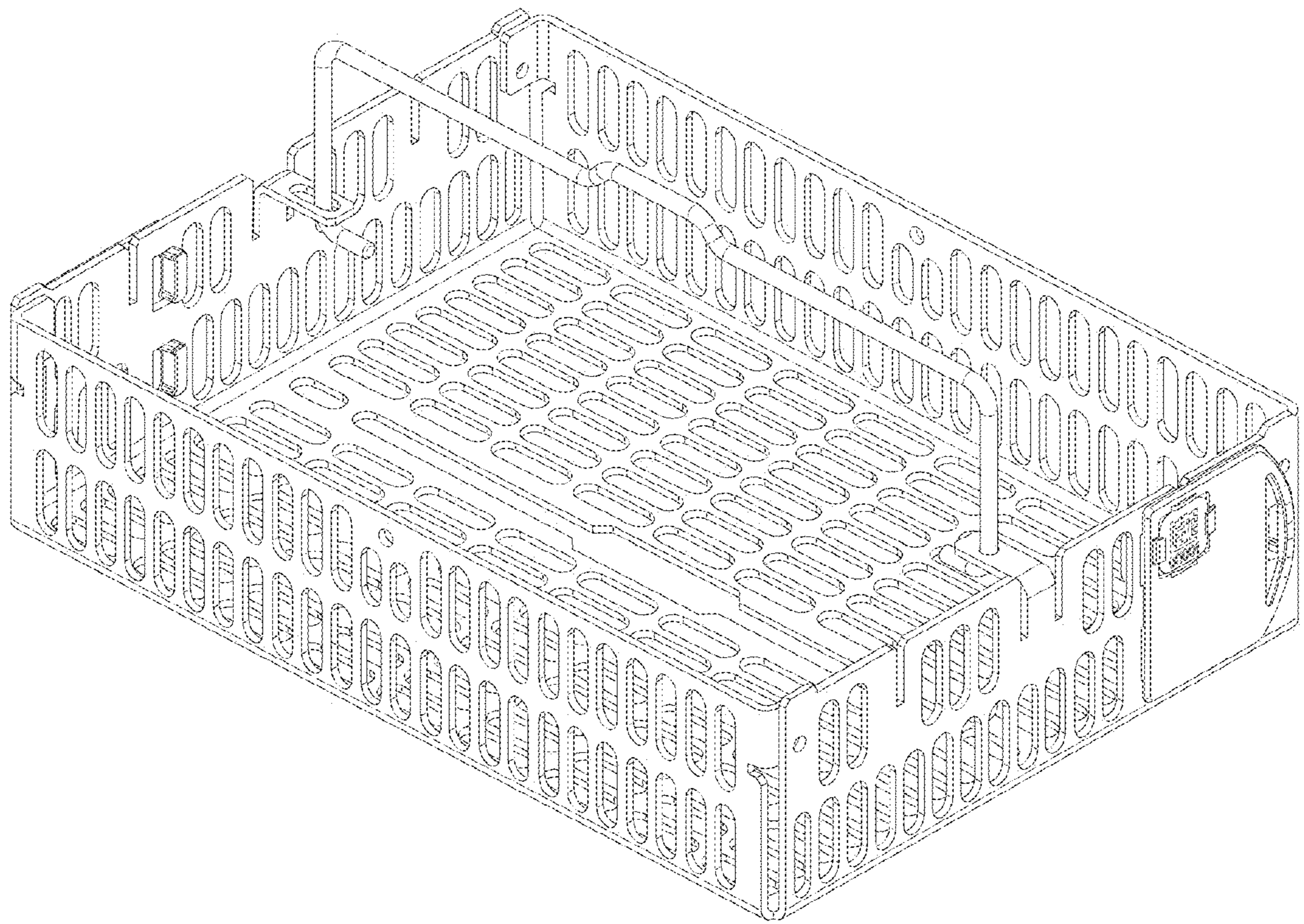

FIG. 20

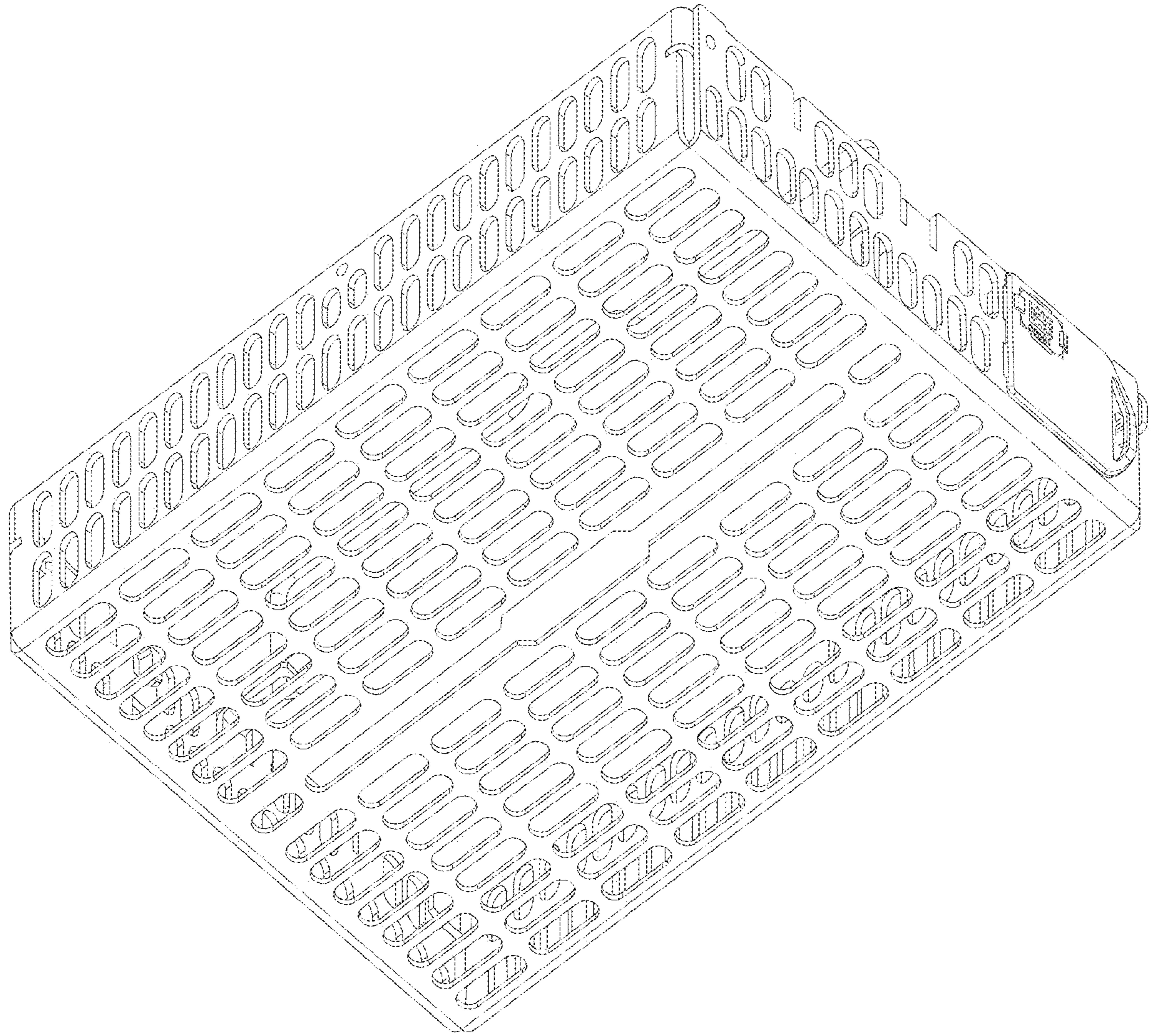

FIG. 21

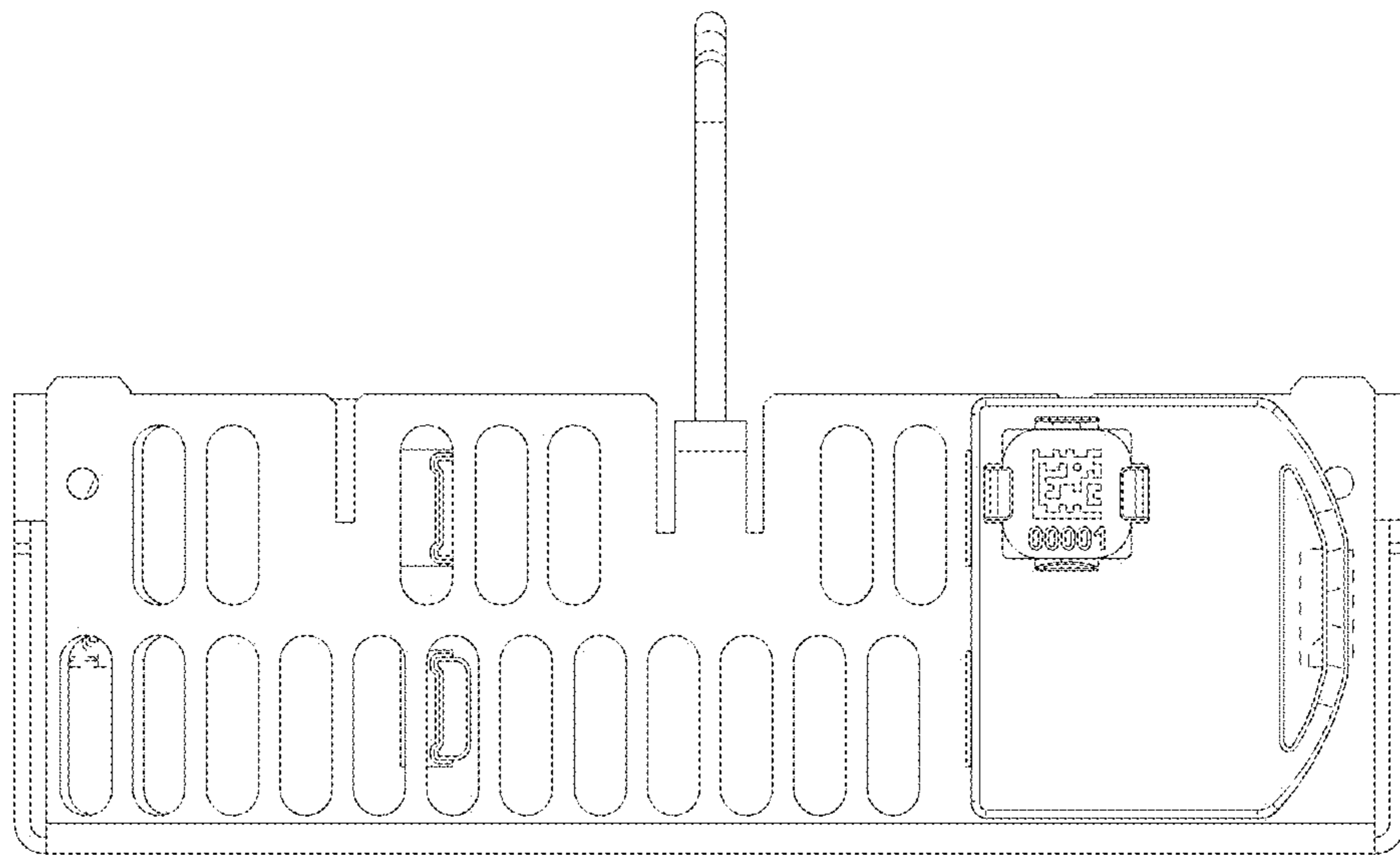

FIG. 22

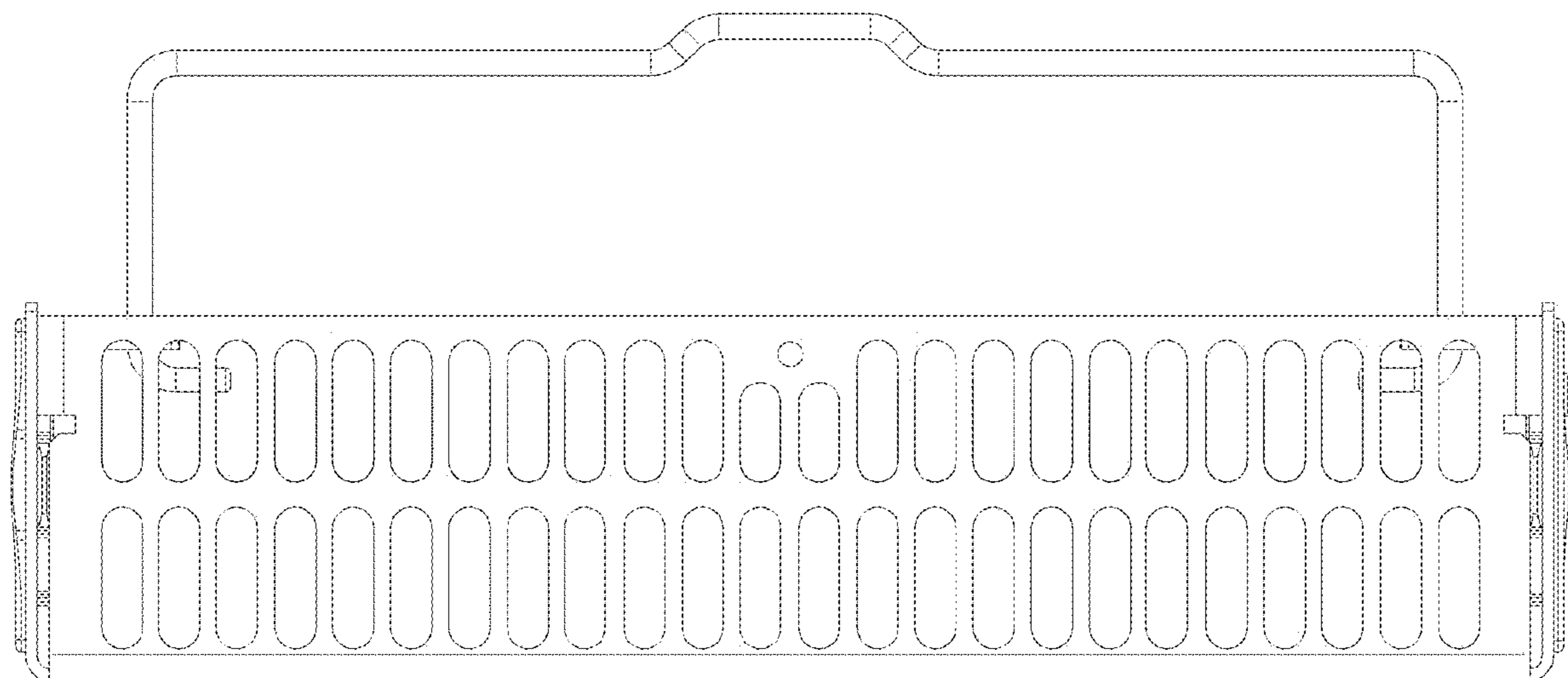

FIG. 23

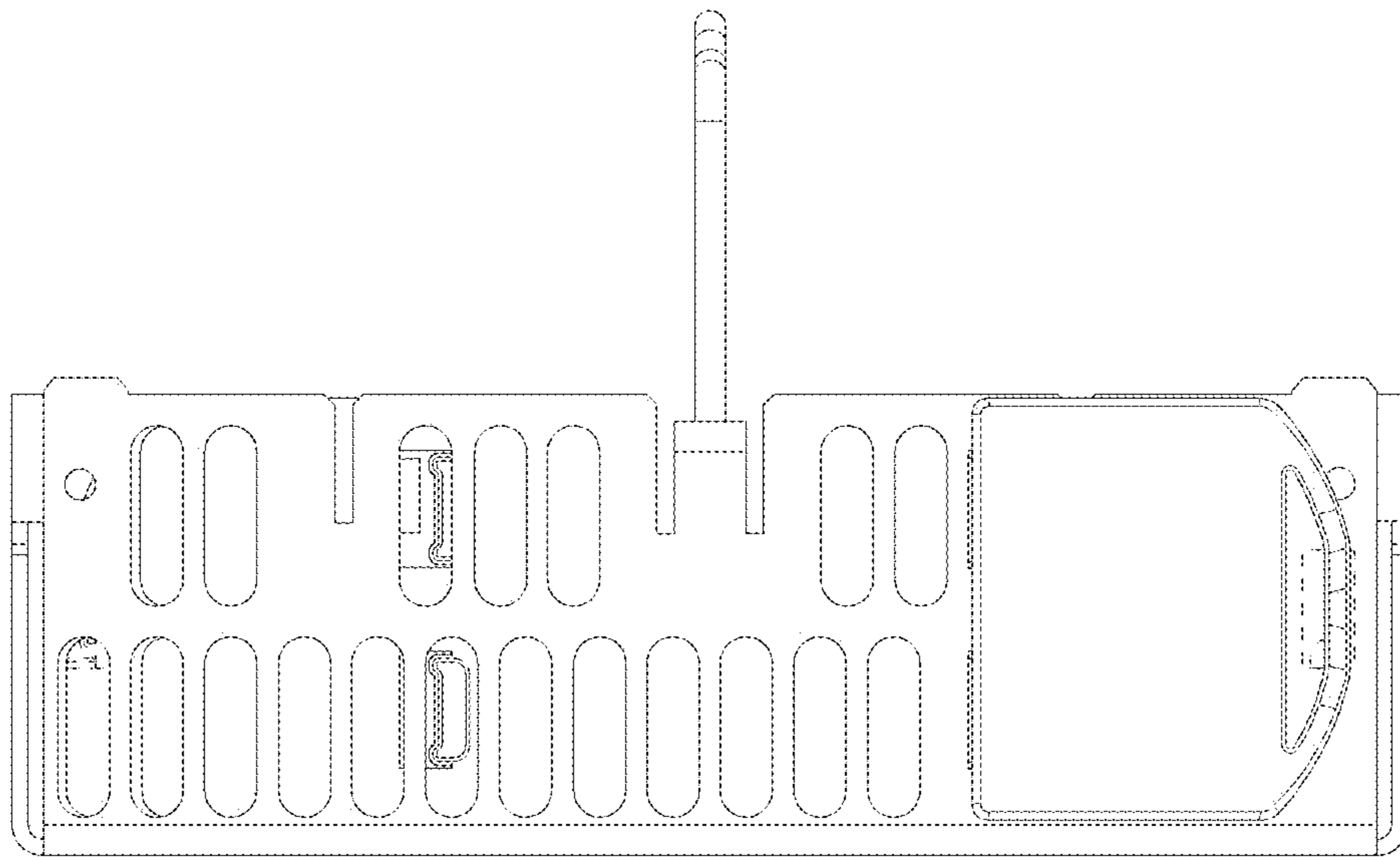

FIG. 24

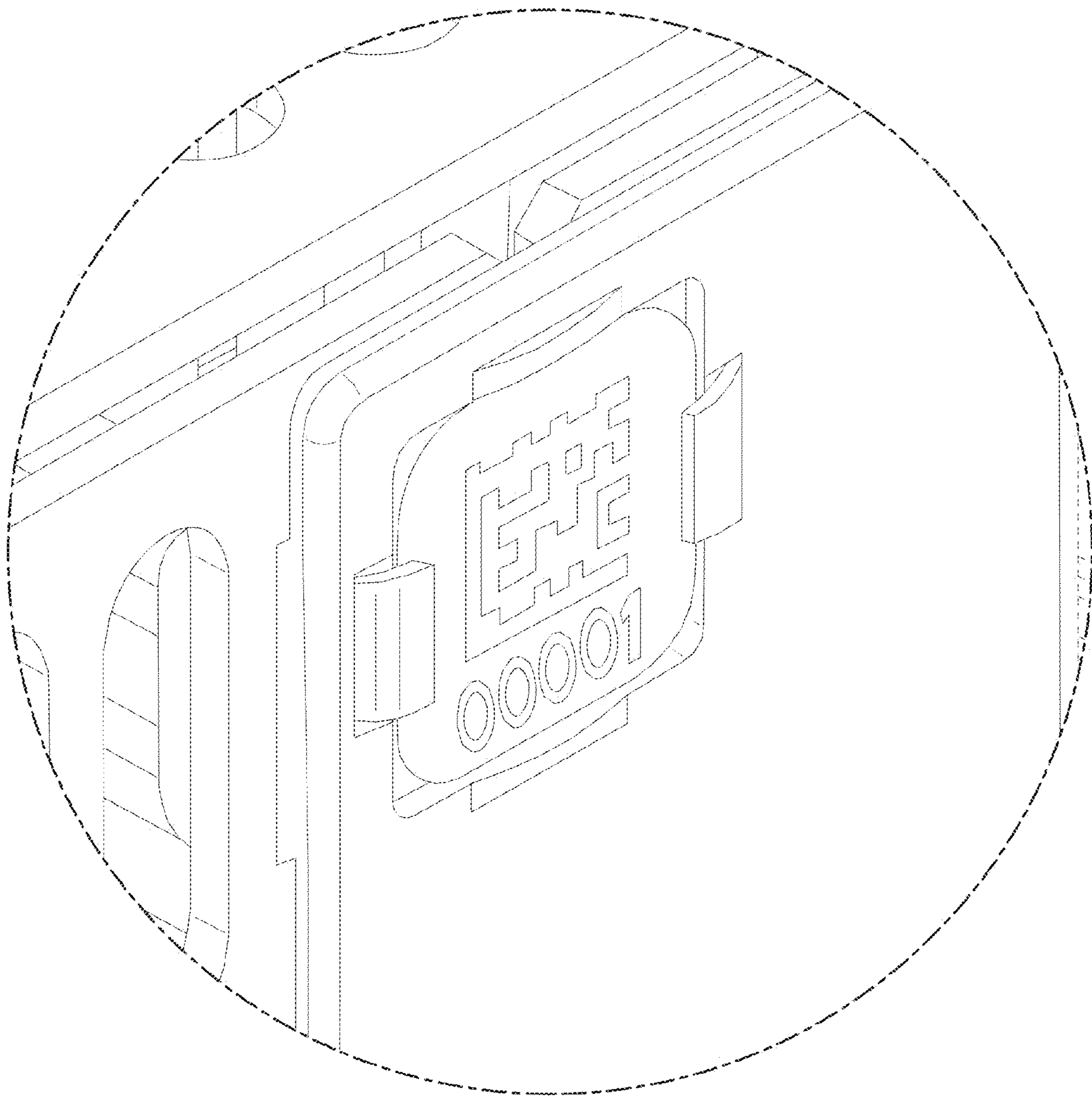

FIG. 25

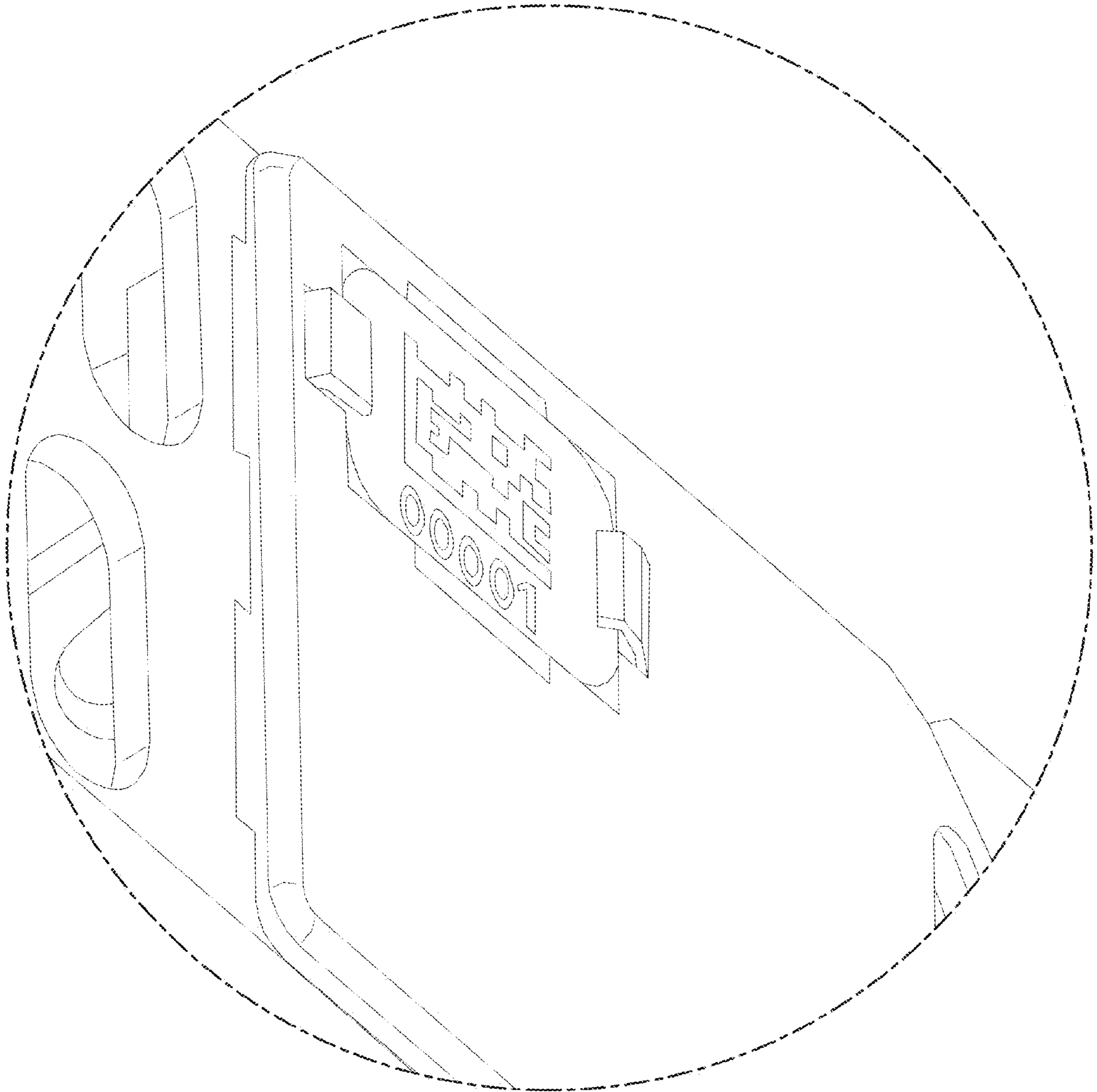

FIG. 26

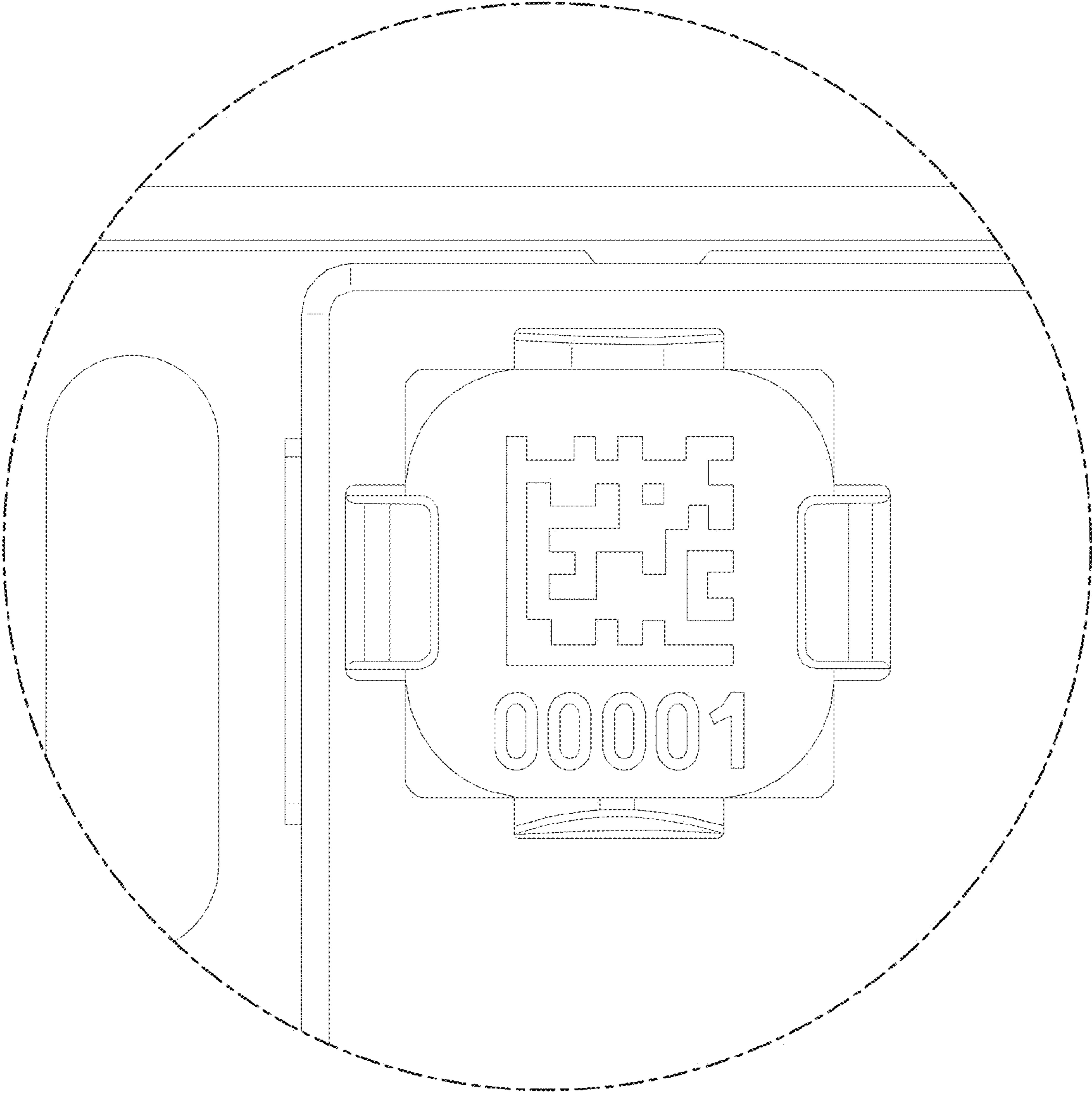

FIG. 27