

US00D908885S

(12) **United States Design Patent**  
**Lockenwitz**

(10) **Patent No.:** **US D908,885 S**

(45) **Date of Patent:** **\*\* Jan. 26, 2021**

(54) **BTE HEARING AID**

(71) Applicant: **Oticon A/S**, Smørum (DK)

(72) Inventor: **Christian Lockenwitz**, Allerød (DK)

(73) Assignee: **OTICON A/S**, Smørum (DK)

(\*\*) Term: **15 Years**

(21) Appl. No.: **29/692,182**

(22) Filed: **May 23, 2019**

(30) **Foreign Application Priority Data**

Nov. 26, 2018 (EM) ..... 005833480-0001

Nov. 26, 2018 (EM) ..... 005833480-0002

(51) **LOC (13) Cl.** ..... **24-99**

(52) **U.S. Cl.**  
USPC ..... **D24/174**

(58) **Field of Classification Search**  
USPC ..... D24/173-175; D14/205, 223-226, 249,  
D14/230, 231, 236

CPC .. H04R 2225/025; H04R 25/60; H04R 25/63;  
H04R 25/67; H04R 25/602; H04R  
25/604; H04R 25/608; H04R 25/65;  
H04R 25/652

See application file for complete search history.

(56) **References Cited**

**U.S. PATENT DOCUMENTS**

D698,025 S \* 1/2014 Jensen ..... D24/174

D705,936 S \* 5/2014 Lockenwitz ..... D24/174

D797,940 S \* 9/2017 Tipsmark ..... D24/174

D806,251 S \* 12/2017 Lockenwitz ..... D24/174

D806,252 S \* 12/2017 Lockenwitz ..... D24/174

D855,187 S \* 7/2019 Lockenwitz ..... D24/174

D855,188 S \* 7/2019 Lockenwitz ..... D24/174

D872,280 S \* 1/2020 Shi ..... D24/174

\* cited by examiner

*Primary Examiner* — Anhdao Doan

(74) *Attorney, Agent, or Firm* — Birch, Stewart, Kolasch  
& Birch, LLP

(57) **CLAIM**

The ornamental design for a BTE hearing aid, as shown and described.

**DESCRIPTION**

FIG. 1 is a perspective view of a BTE hearing aid;

FIG. 2 is a rear view thereof;

FIG. 3 is a front view thereof;

FIG. 4 is a right side view thereof;

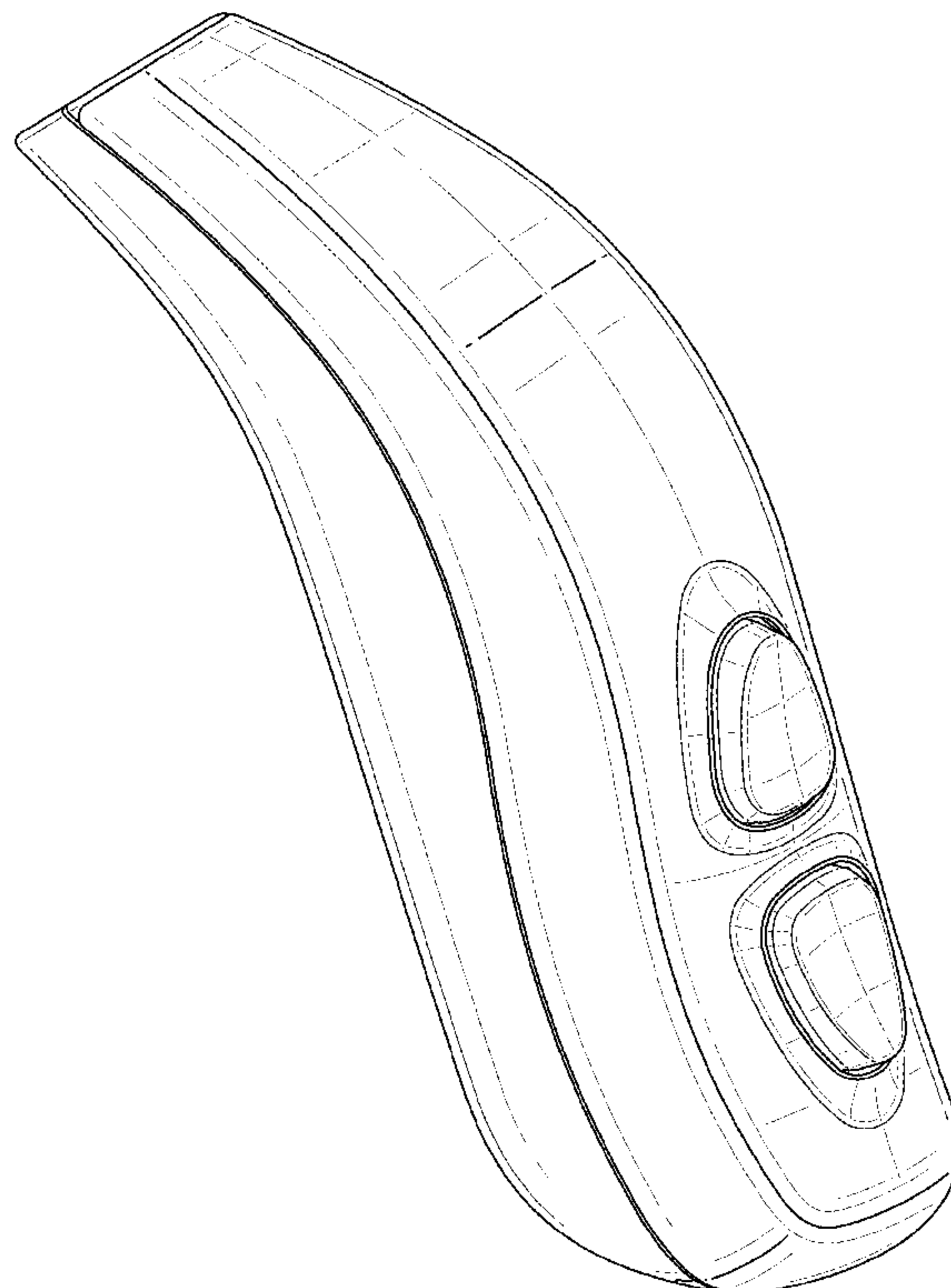
FIG. 5 is a left side view thereof;

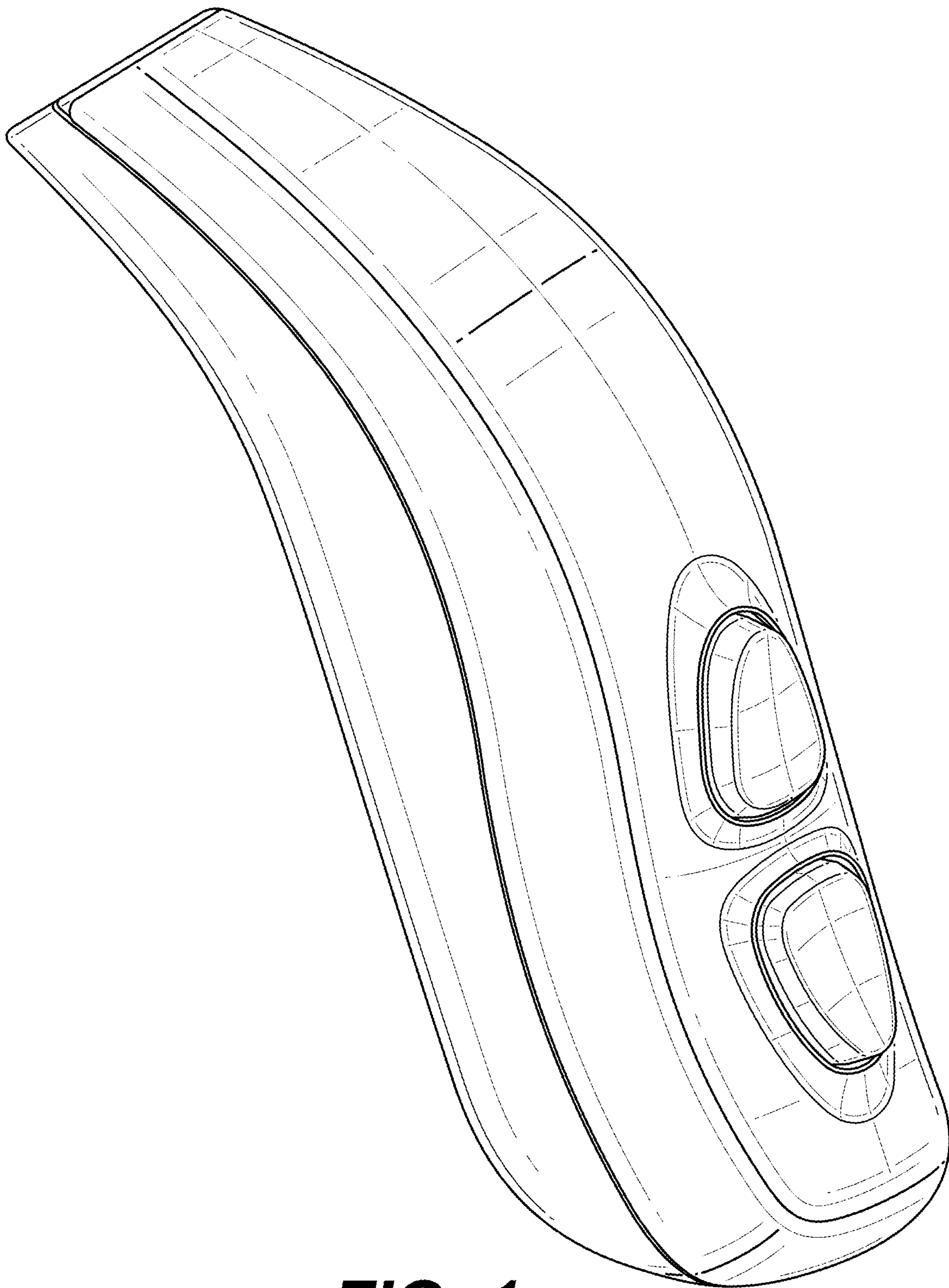
FIG. 6 is a top view thereof; and,

FIG. 7 is a bottom view thereof.

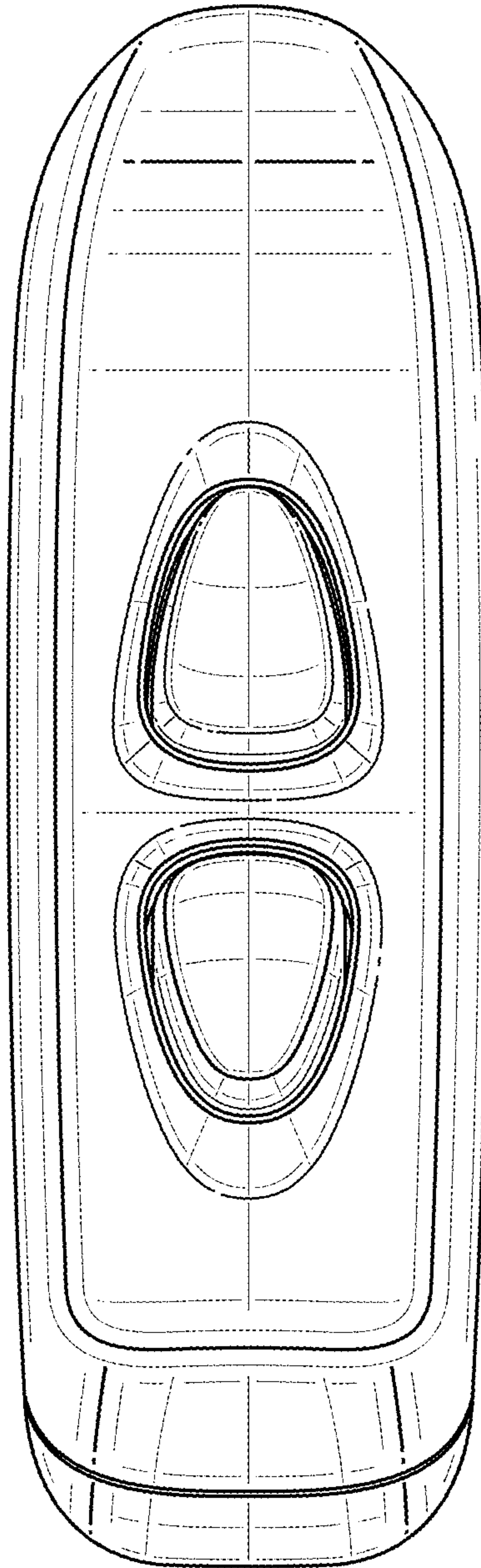
The broken lines in FIGS. 3 and 6 represent the bounds of the claim and form no part of the claimed design.

**1 Claim, 7 Drawing Sheets**

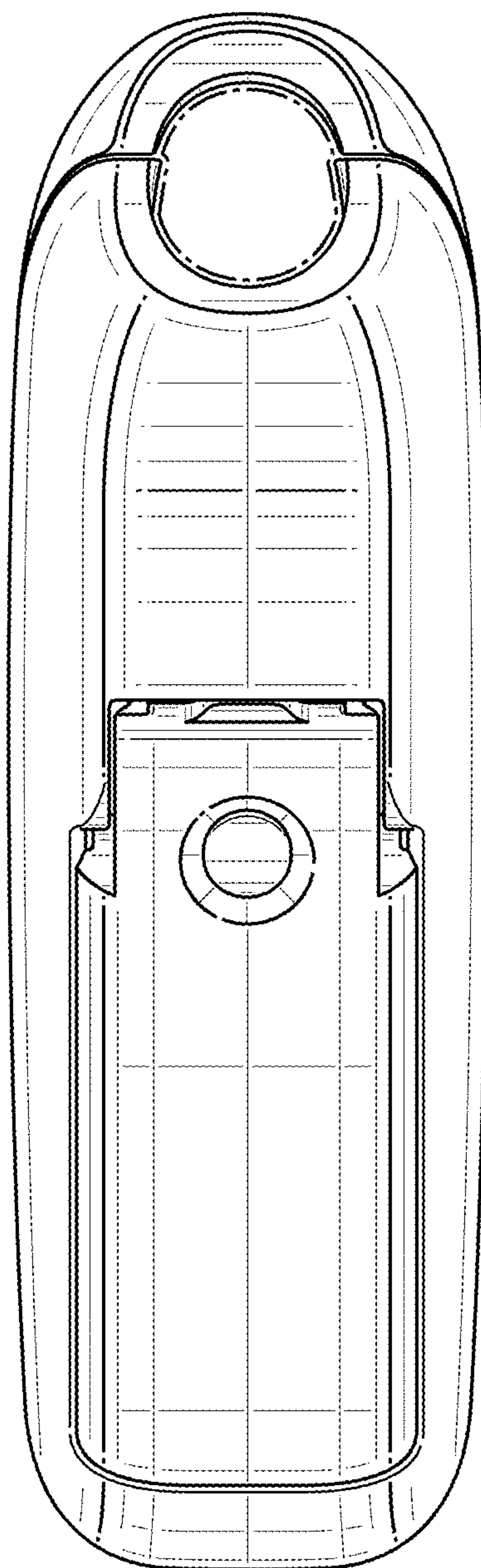




**FIG. 1**

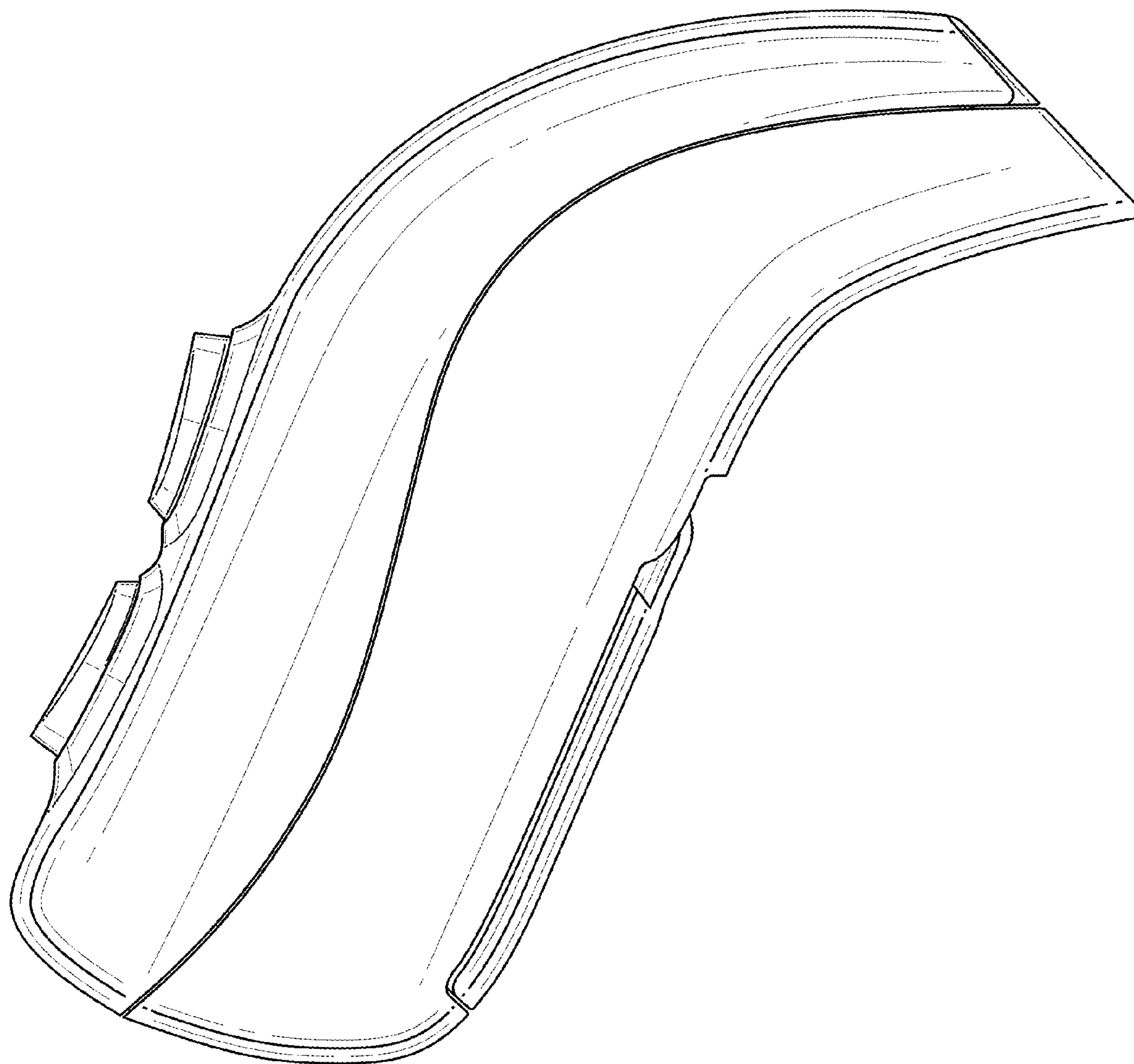


**FIG. 2**

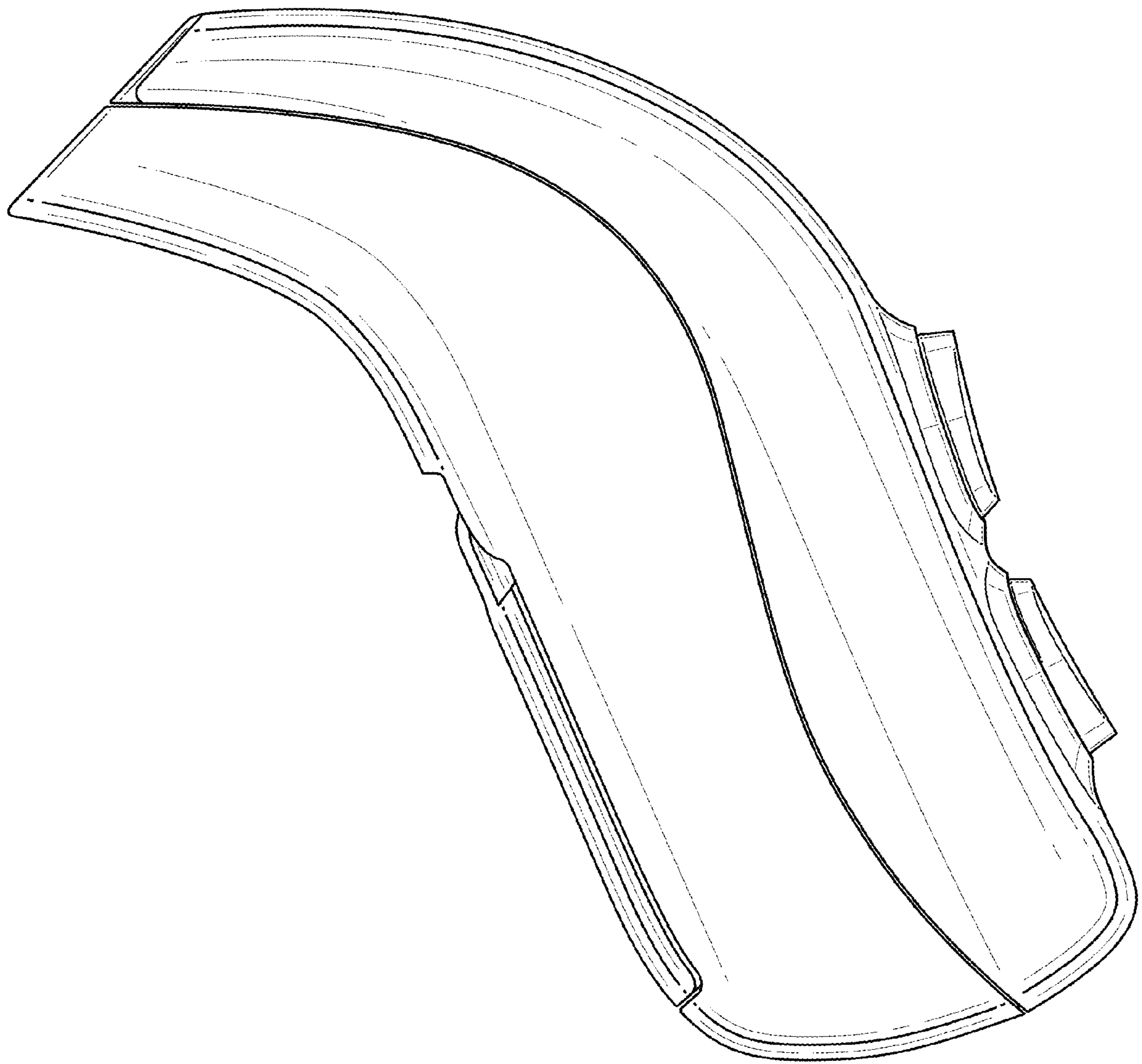


**FIG. 3**

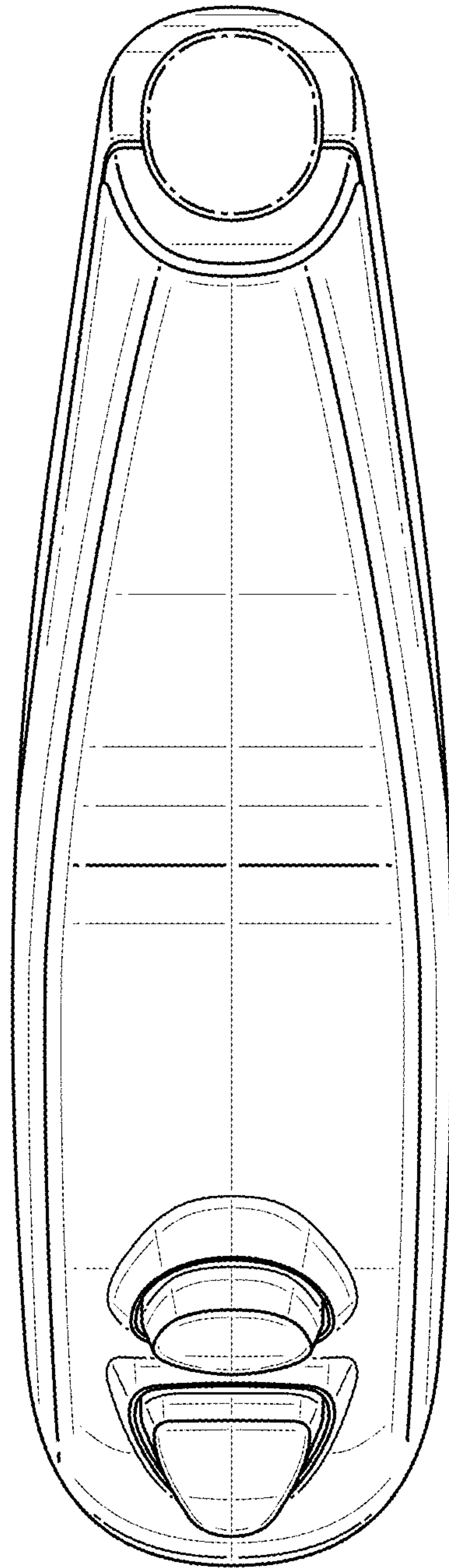




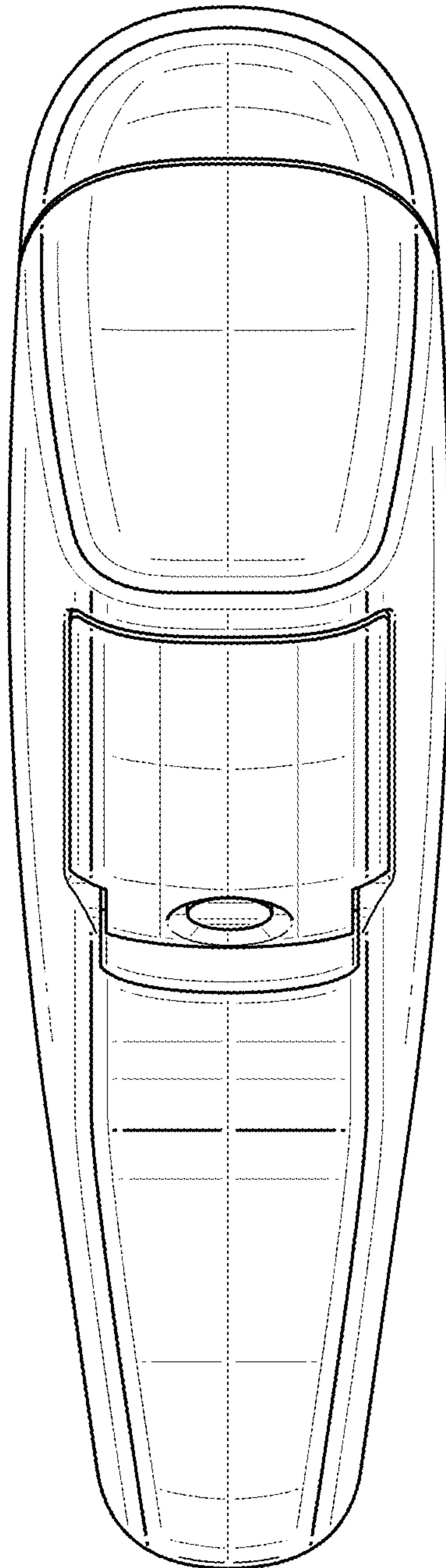
**FIG. 4**



**FIG. 5**



**FIG. 6**



**FIG. 7**