



US00D908864S

(12) **United States Design Patent**  
**Sidhu**

(10) **Patent No.:** **US D908,864 S**  
(45) **Date of Patent:** **\*\* Jan. 26, 2021**

- (54) **SUCTION TOOL**
- (71) Applicant: **SafeVac, LLC**, Las Vegas, NV (US)
- (72) Inventor: **Jessy Sidhu**, Las Vegas, NV (US)
- (73) Assignee: **SafeVac, LLC**, Las Vegas, NV (US)
- (\*\*) Term: **15 Years**
- (21) Appl. No.: **29/639,645**
- (22) Filed: **Mar. 7, 2018**
- (51) **LOC (13) Cl.** ..... **24-02**
- (52) **U.S. Cl.**  
USPC ..... **D24/112**
- (58) **Field of Classification Search**  
USPC ..... D24/112–114, 108, 130, 127, 133, 186;  
606/181, 185; 604/264, 523–528, 272,  
604/164.01–164.11, 187, 93.01; 600/101,  
600/139, 143; 128/200.24, 207.14,  
128/207.15  
CPC ..... A61M 25/00; A61M 39/00; A61M 27/00;  
A61M 25/0043; A61M 25/0067; A61M  
25/0097; A61F 2/958  
See application file for complete search history.

(56) **References Cited**

**U.S. PATENT DOCUMENTS**

- 4,265,621 A \* 5/1981 McVey ..... A61C 17/08  
433/91
- D632,387 S \* 2/2011 Sidhu ..... A61C 17/08  
D24/112
- D642,330 S \* 7/2011 Turner ..... D24/133
- D656,545 S \* 3/2012 Hung ..... D19/117

- D663,831 S \* 7/2012 Sidhu ..... D24/112
- D683,448 S \* 5/2013 Sidhu ..... D24/112
- D683,449 S \* 5/2013 Sidhu ..... D24/112
- D685,087 S \* 6/2013 Voic ..... D24/133
- D797,281 S \* 9/2017 Ohashi ..... D24/130
- D811,587 S \* 2/2018 Mitchell ..... D24/112
- D819,804 S \* 6/2018 Knight ..... D24/113
- D831,208 S \* 10/2018 Benisty ..... D24/144
- 2013/0211330 A1 \* 8/2013 Pedersen ..... A61M 5/2033  
604/111

\* cited by examiner

*Primary Examiner* — David G Muller

(74) *Attorney, Agent, or Firm* — Mintz Levin Cohn Ferris  
Glovsky and Popeo, P.C.; Marc T. Morley; Joshua D.  
Berk

(57) **CLAIM**

The ornamental design for a suction tool, as shown and described.

**DESCRIPTION**

FIG. 1 is a front, side, and top perspective view of a suction tool of our design;  
 FIG. 2 is a front view thereof;  
 FIG. 3 is a rear view thereof;  
 FIG. 4 is a left side view thereof;  
 FIG. 5 is right side view thereof;  
 FIG. 6 is a top view thereof; and,  
 FIG. 7 is a bottom view thereof.  
 The broken lines show portions of the drawings that form no part of the claimed design.

**1 Claim, 4 Drawing Sheets**

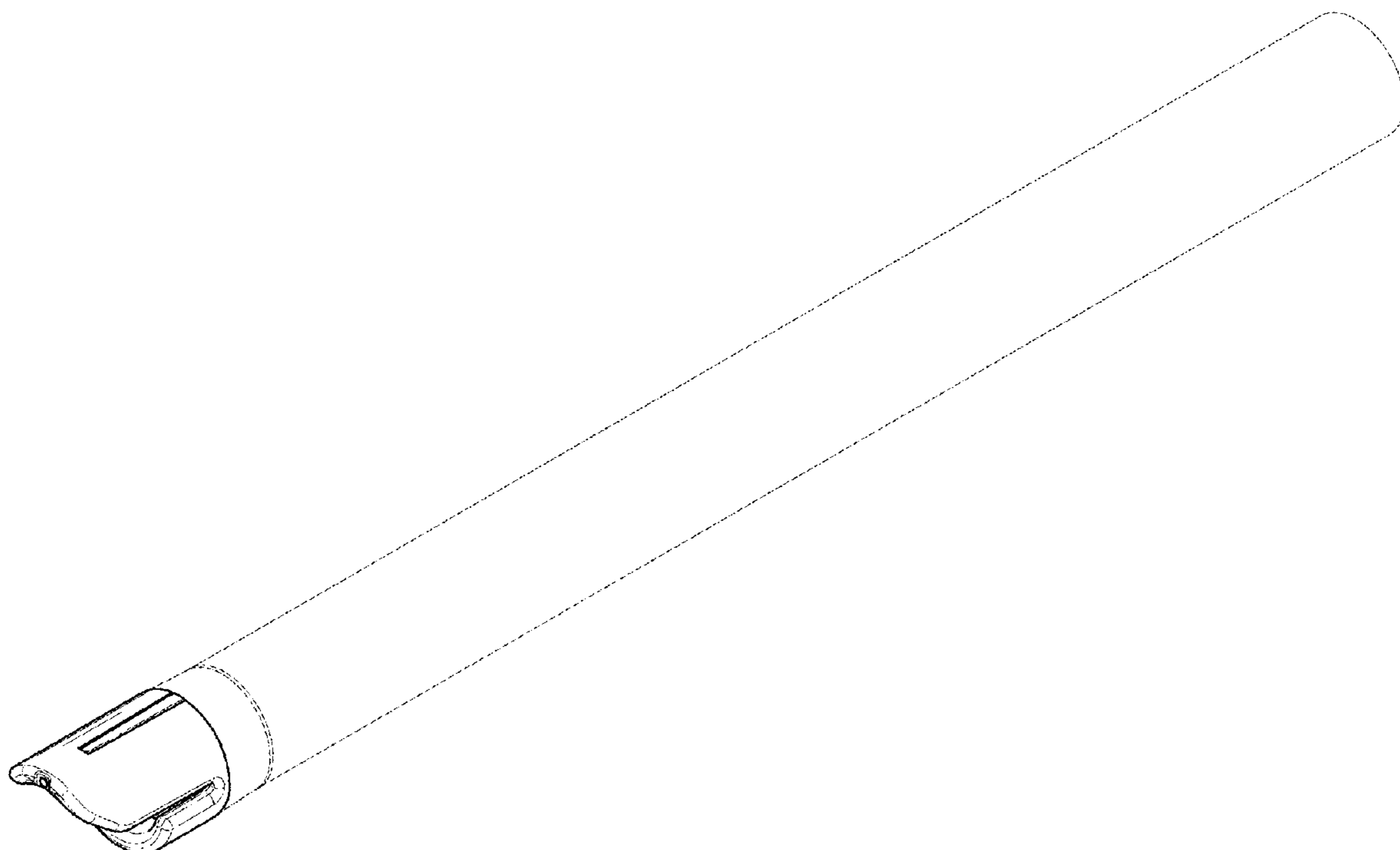
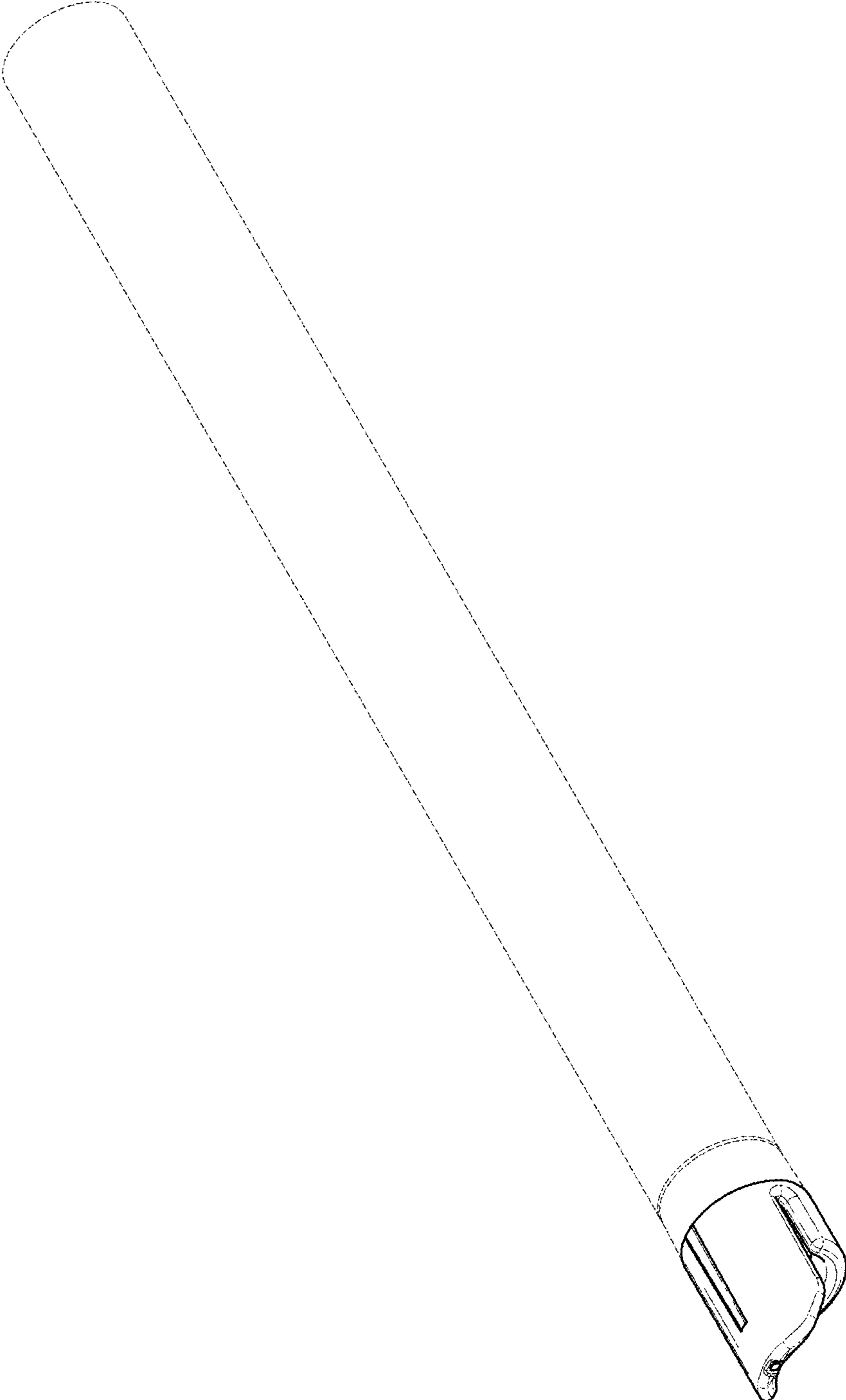

FIG. 1



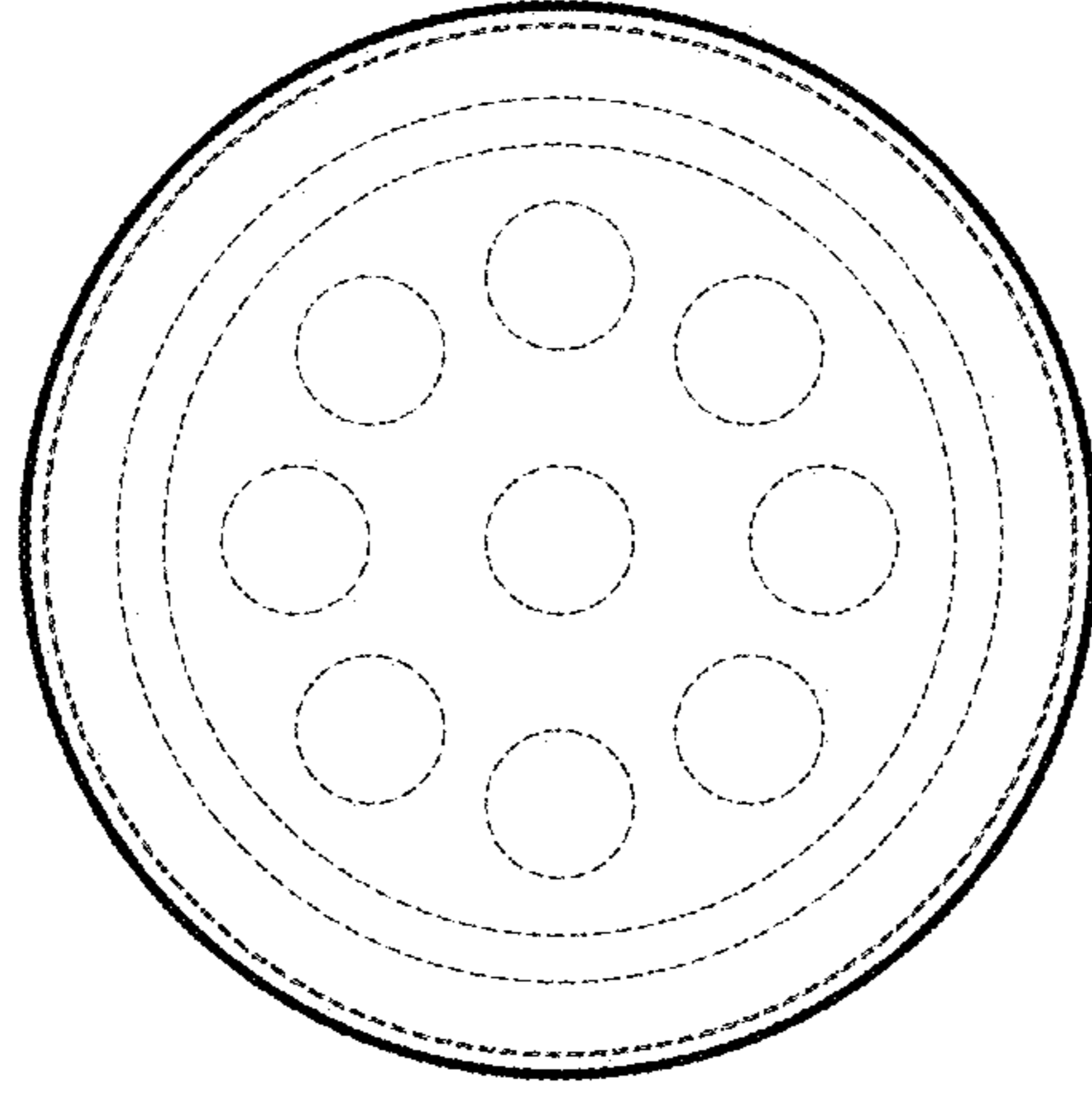

FIG. 3

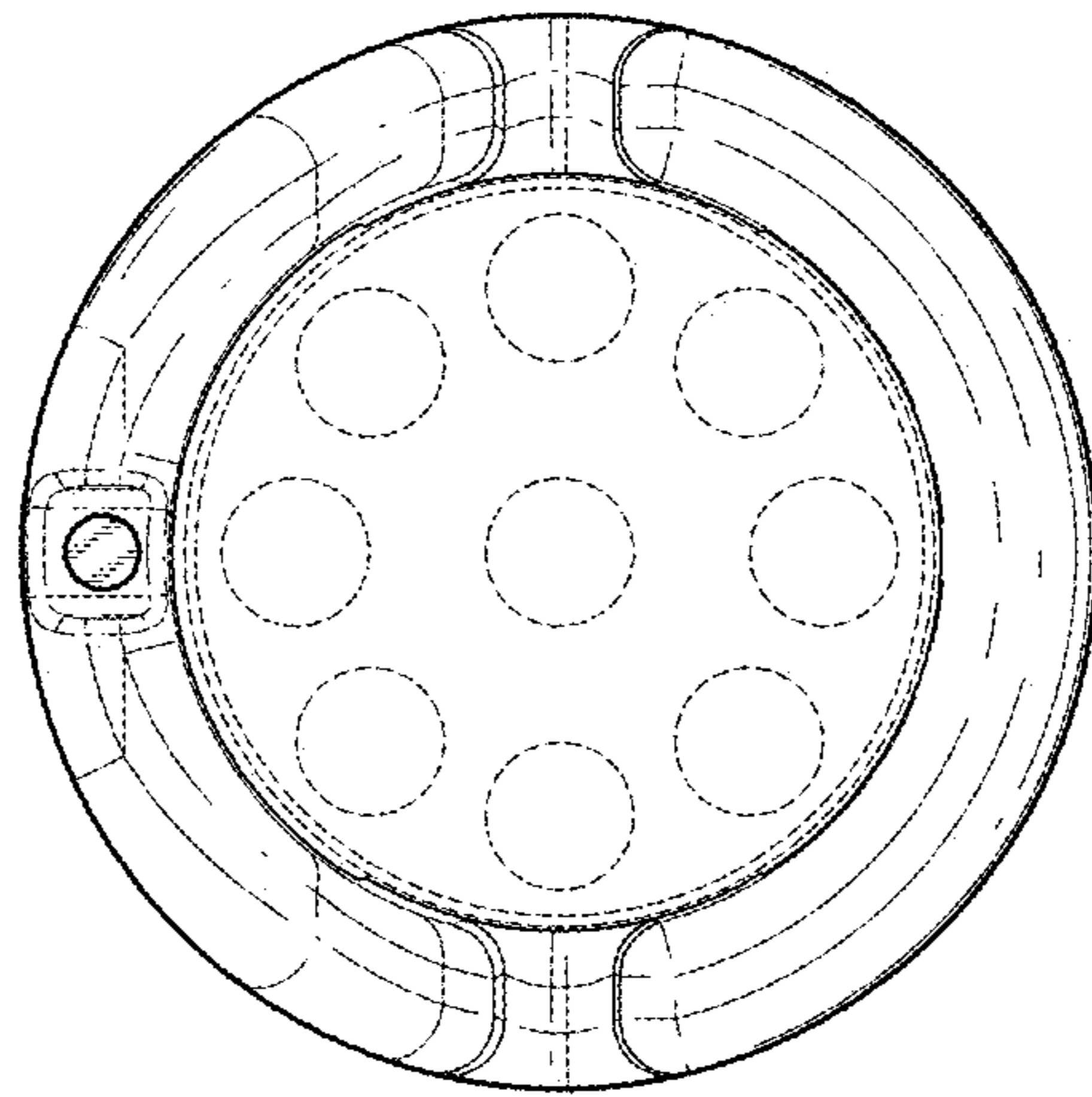

FIG. 2

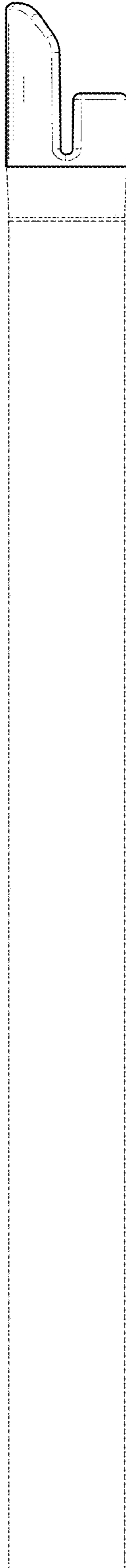

FIG. 4

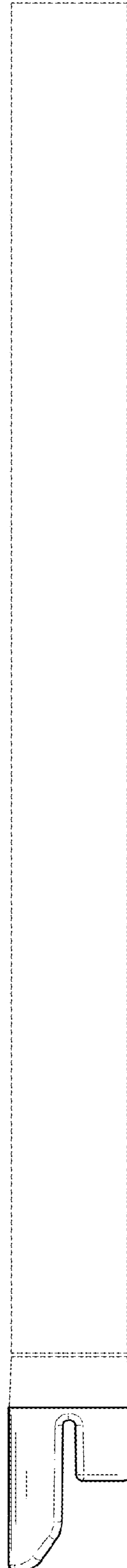

FIG. 5

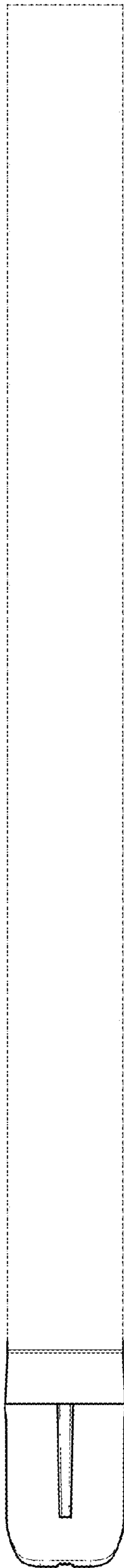

FIG. 6

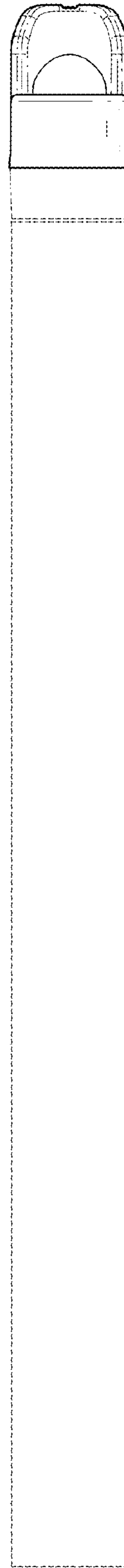

FIG. 7