



US00D908852S

(12) **United States Design Patent**
Zhao

(10) **Patent No.:** **US D908,852 S**
(45) **Date of Patent:** **** Jan. 26, 2021**

- (54) **PORTABLE AIR CONDITIONER**
- (71) Applicant: **SHENZHEN Keku Technology Co., Ltd.**, Shenzhen (CN)
- (72) Inventor: **Xinghan Zhao**, Shenzhen (CN)
- (73) Assignee: **SHENZHEN Keku Technology Co., Ltd.**, Shenzhen (CN)
- (**) Term: **15 Years**

D553,718 S *	10/2007	Shapiro	D23/314
D595,395 S *	6/2009	Lewis	D23/314
D639,921 S *	6/2011	Levano	D23/332
D691,255 S *	10/2013	Abbondanzio	D23/366
D722,147 S *	2/2015	Lewis	D23/332
D735,843 S *	8/2015	Sunwoo	D23/333
D755,942 S *	5/2016	Kim	D23/364
D791,290 S *	7/2017	Shapiro	D23/332
D799,016 S *	10/2017	Su	D23/364
D841,140 S *	2/2019	Chen	D23/336
D850,592 S *	6/2019	Jacobs	D23/317
D850,594 S *	6/2019	Shapiro	D23/337

(21) Appl. No.: **29/706,414**

(22) Filed: **Sep. 20, 2019**

(30) **Foreign Application Priority Data**

Mar. 22, 2019 (CN) 2019 3 0122056

(51) **LOC (13) Cl.** **23-04**

(52) **U.S. Cl.**
USPC **D23/333**

(58) **Field of Classification Search**
 USPC D23/333, 351-354, 388
 CPC F24F 1/00; F24F 1/0007; F24F 1/02; F24F 1/08; F24F 1/42; F24F 1/56; F24F 1/60; F24F 3/044; F24F 3/048; F24F 3/16; G05D 23/1905; G05D 23/1932; G05D 23/1902; G05D 23/1931; G05B 19/0426; G05B 19/409; G05B 15/02
 See application file for complete search history.

(56) **References Cited**

U.S. PATENT DOCUMENTS

D308,414 S *	6/1990	Makihara	D23/359
D549,310 S *	8/2007	Hou	D23/333

* cited by examiner

Primary Examiner — Natasha Vujcic

(74) *Attorney, Agent, or Firm* — JCIP Global Inc.

(57) **CLAIM**

The ornamental design for a portable air conditioner, as shown and described.

DESCRIPTION

FIG. 1 is a perspective view of a portable air conditioner showing my new design;
 FIG. 2 is another perspective view thereof;
 FIG. 3 is a front view thereof;
 FIG. 4 is a rear view thereof;
 FIG. 5 is a left side view thereof;
 FIG. 6 is a right side view thereof;
 FIG. 7 is a top view thereof; and,
 FIG. 8 is a bottom view thereof.
 The broken line portions of the portable air conditioner in FIGS. 1-8 represent unclaimed portions of the claimed design and form no part thereof.

1 Claim, 7 Drawing Sheets

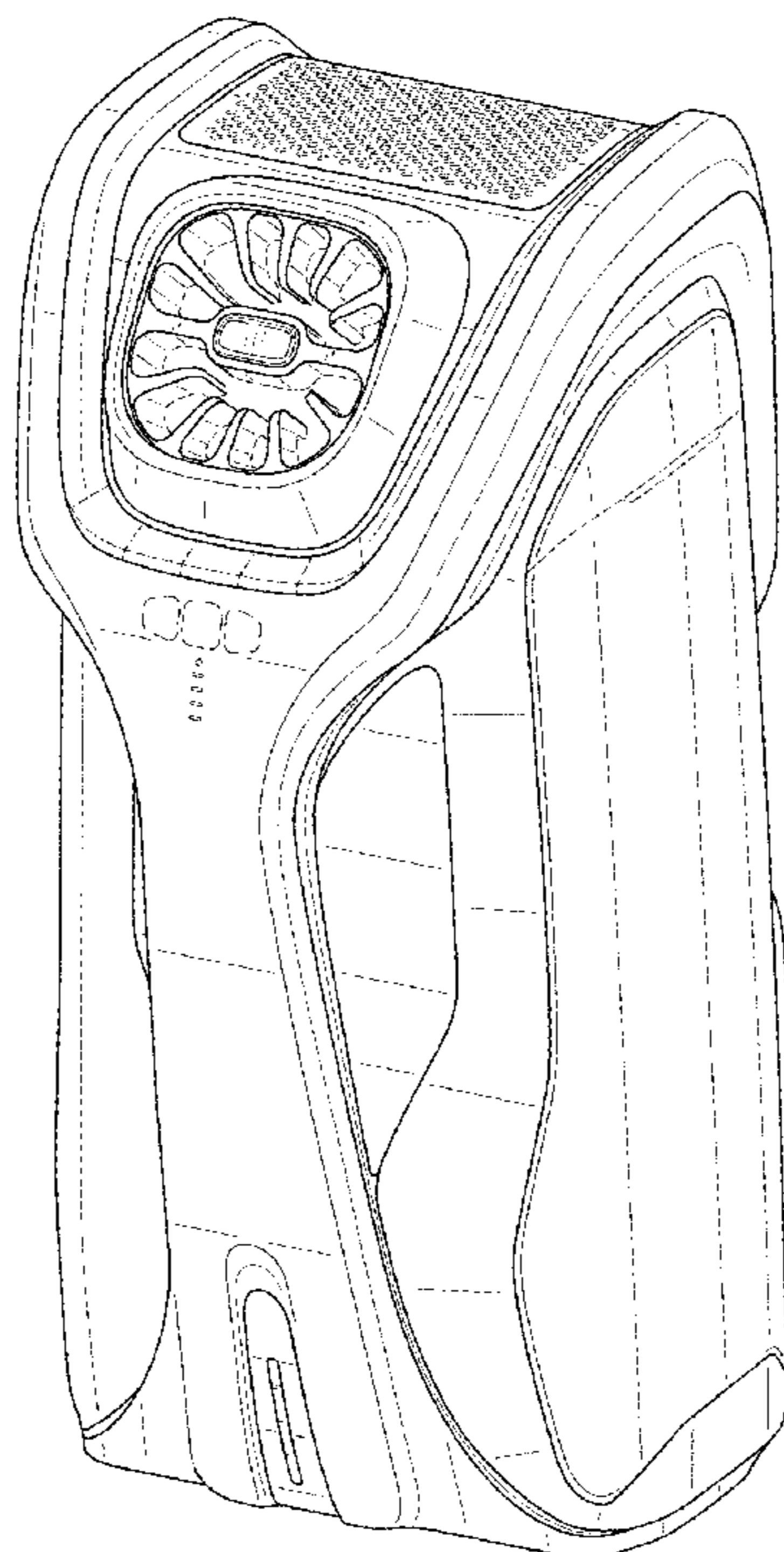

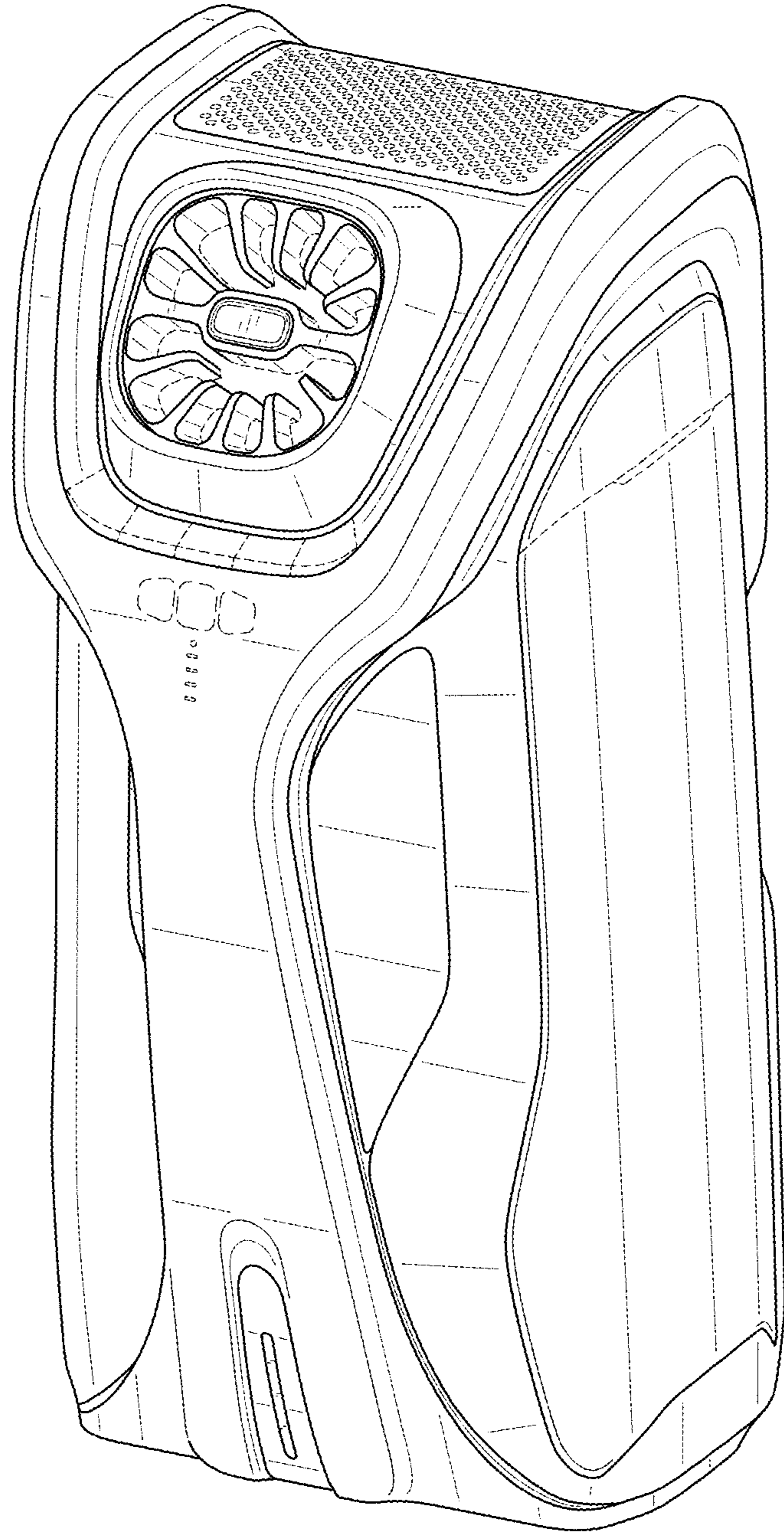

FIG. 1

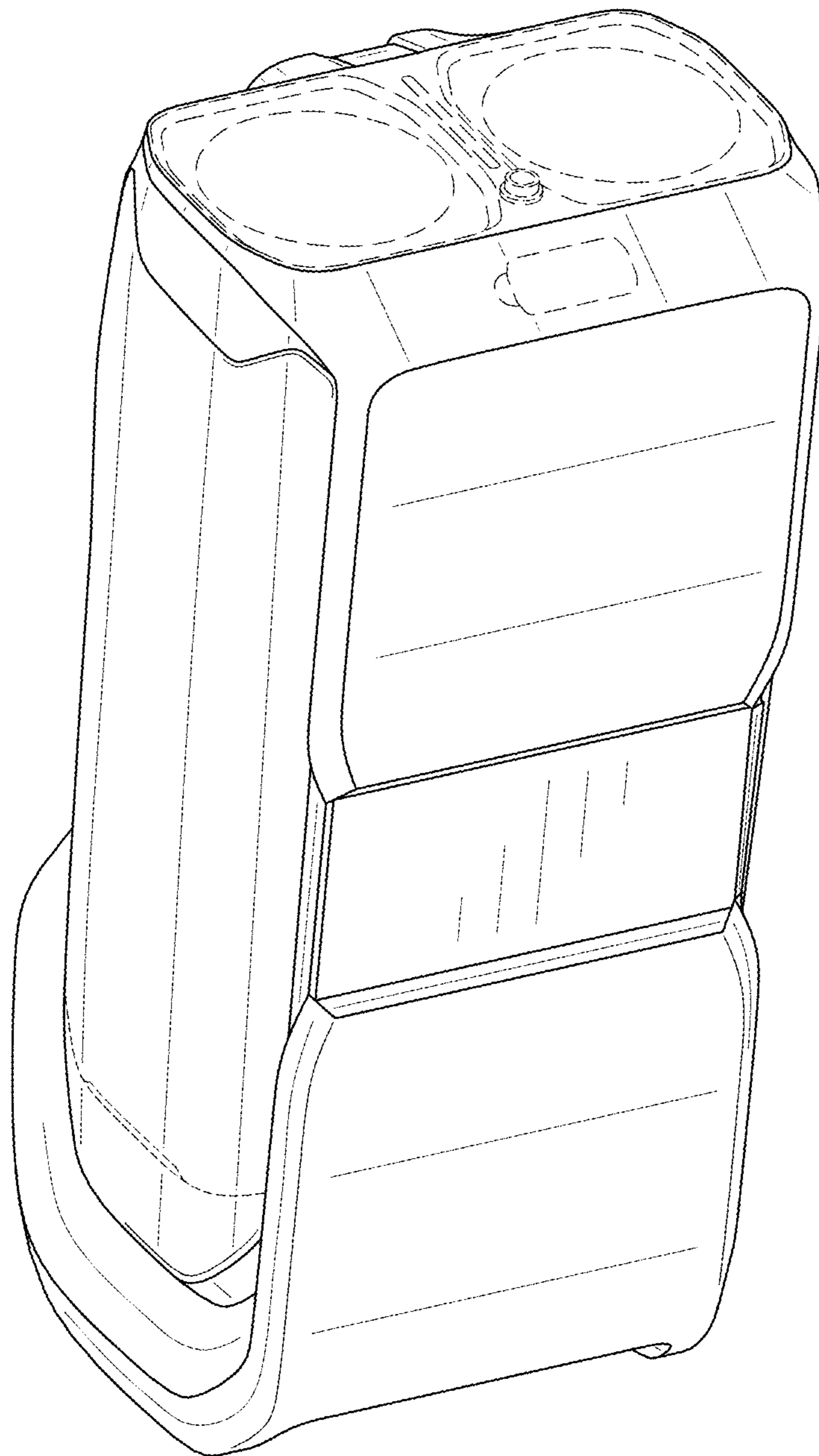

FIG. 2

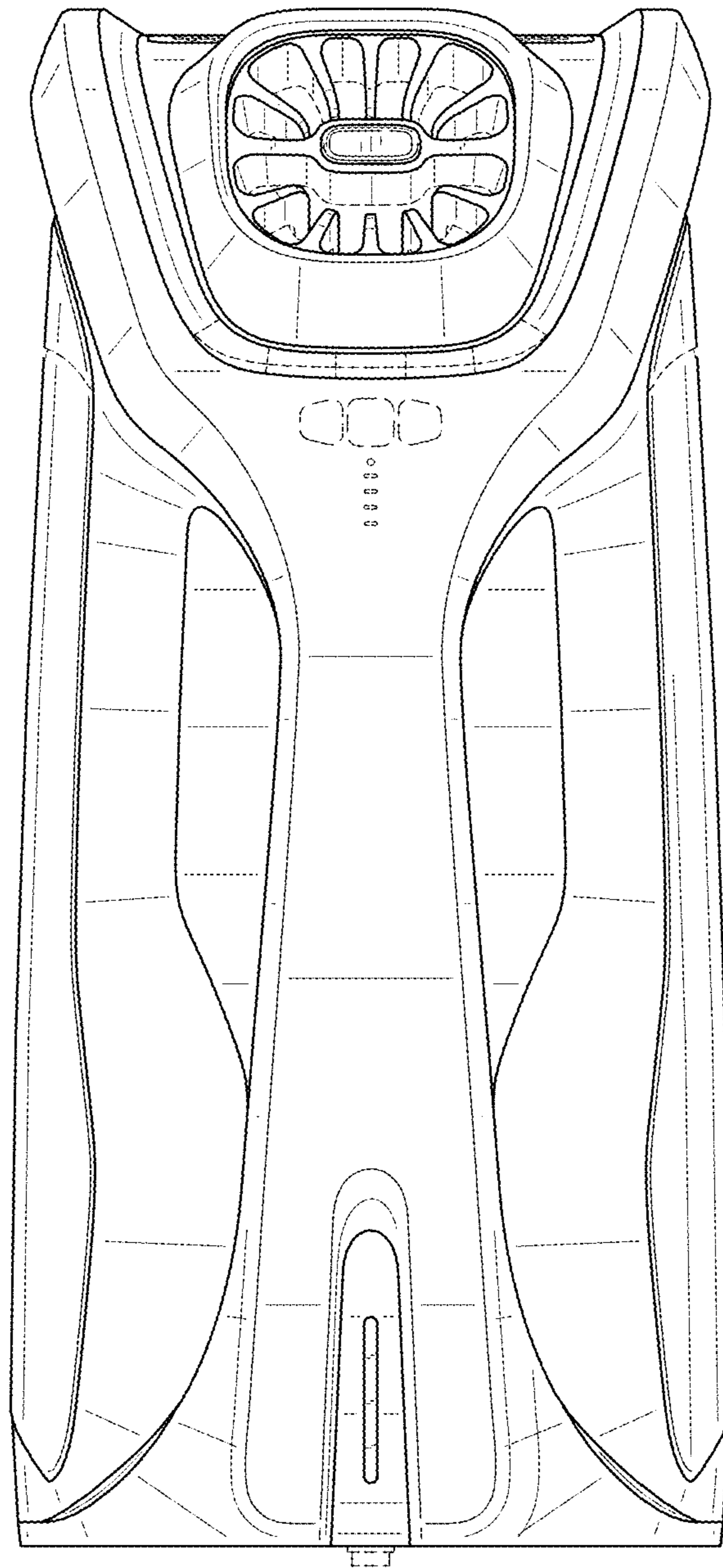

FIG. 3

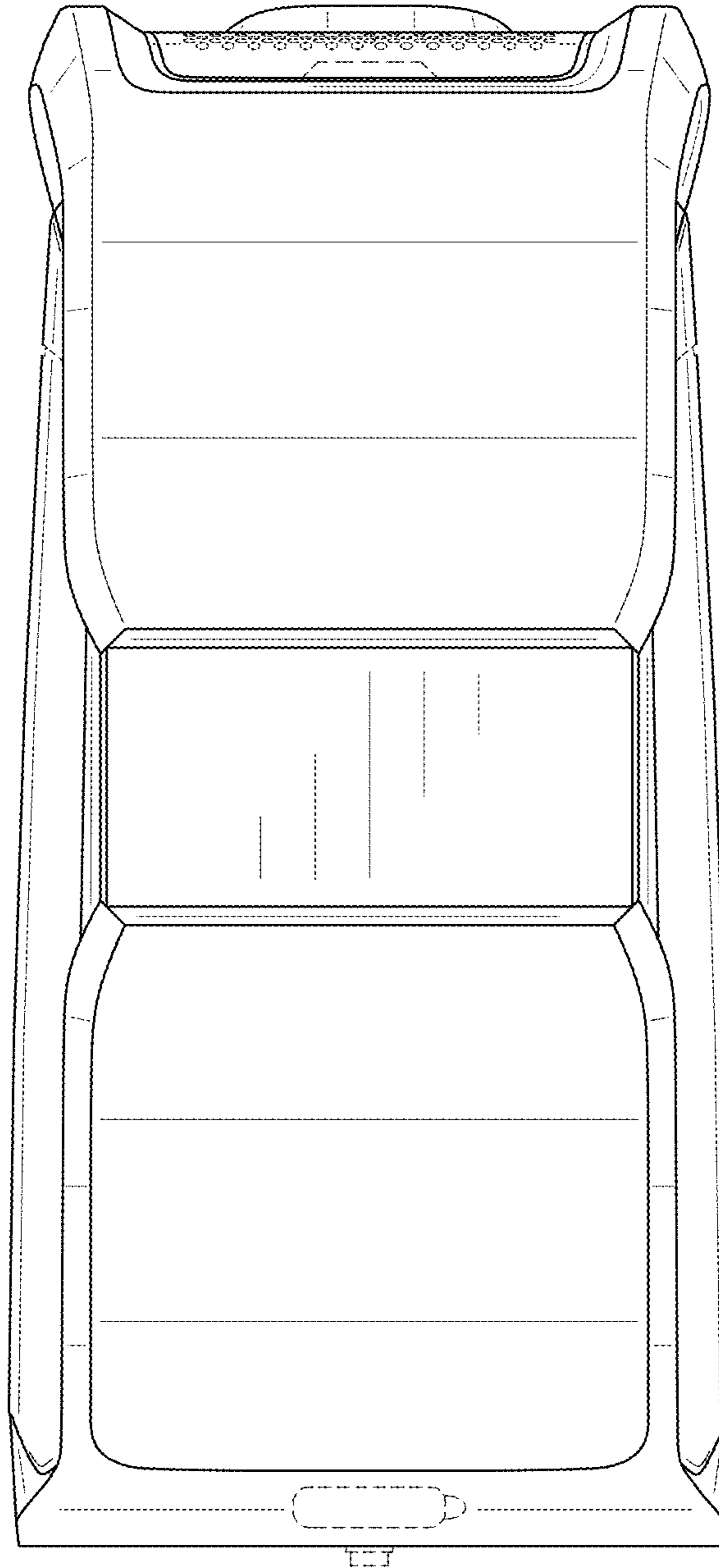

FIG. 4

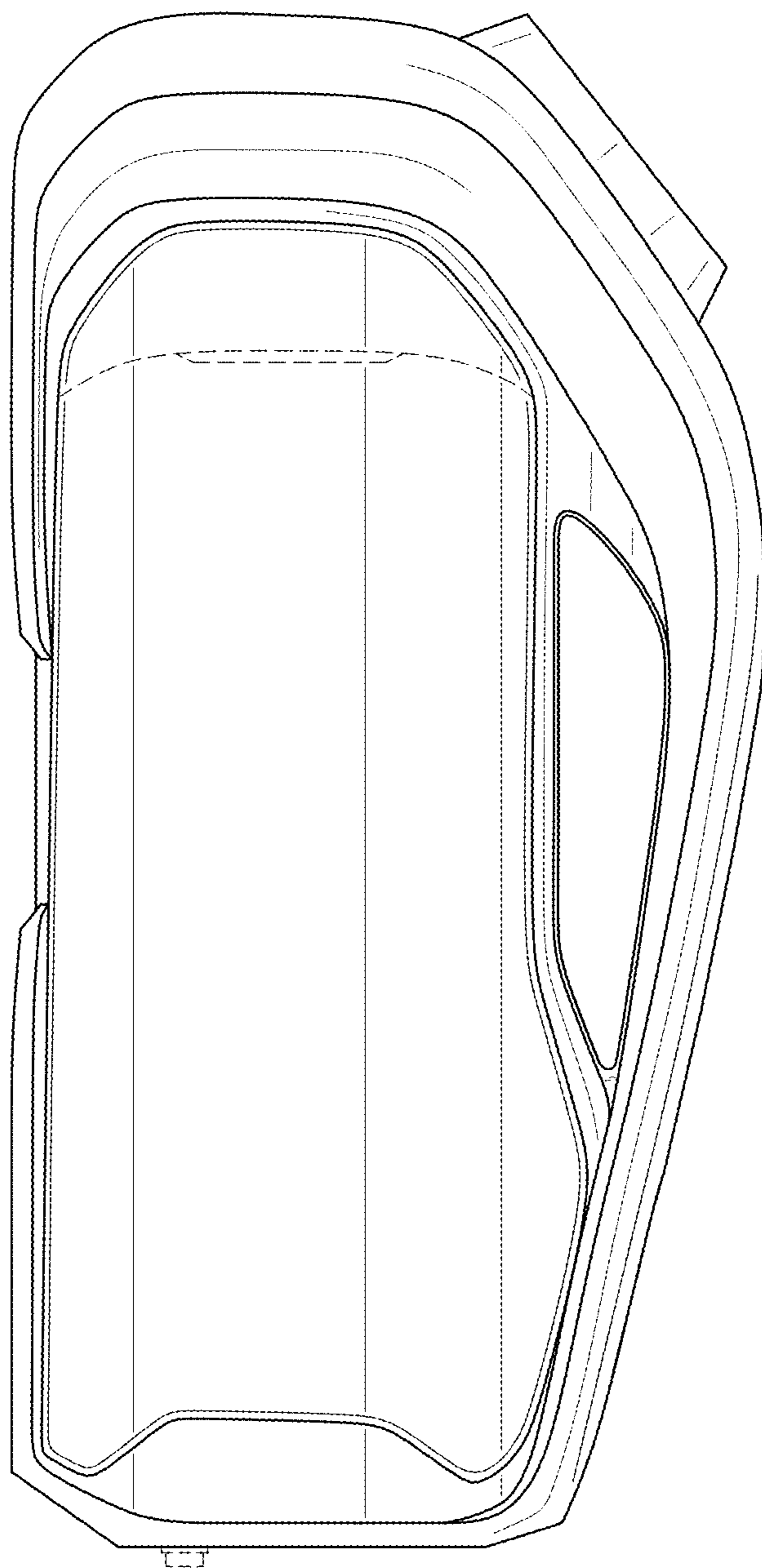

FIG. 5

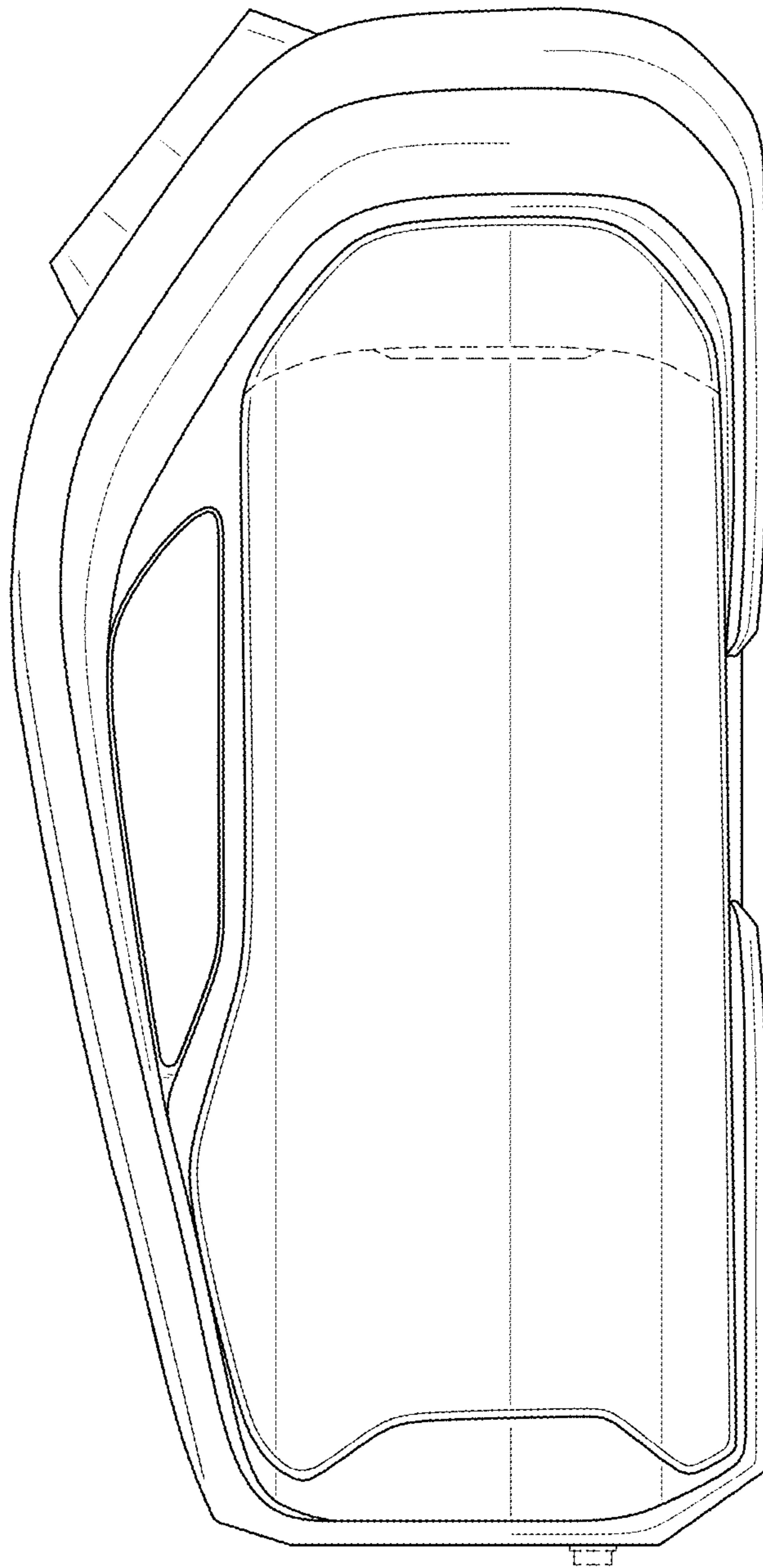

FIG. 6

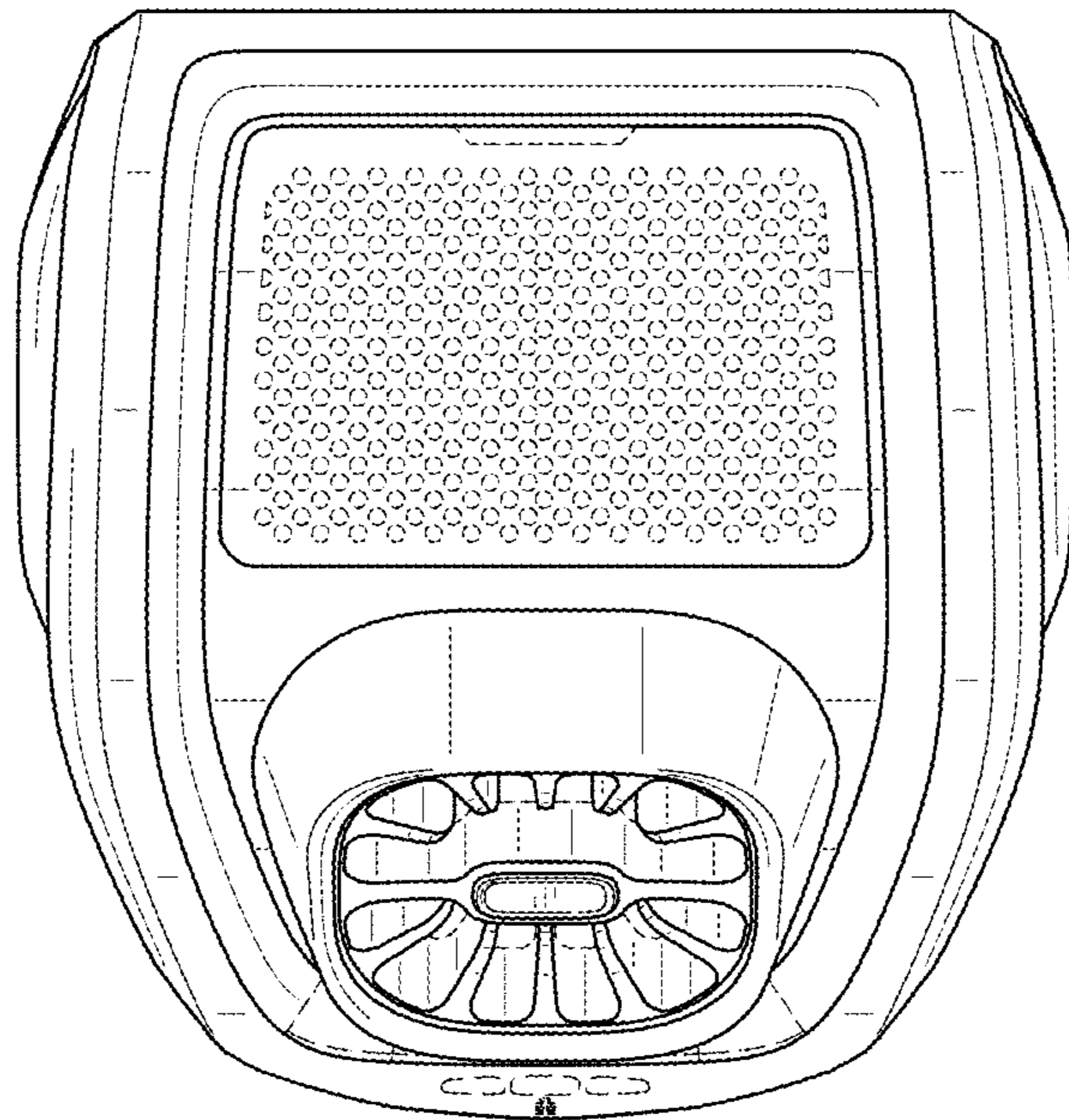

FIG. 7

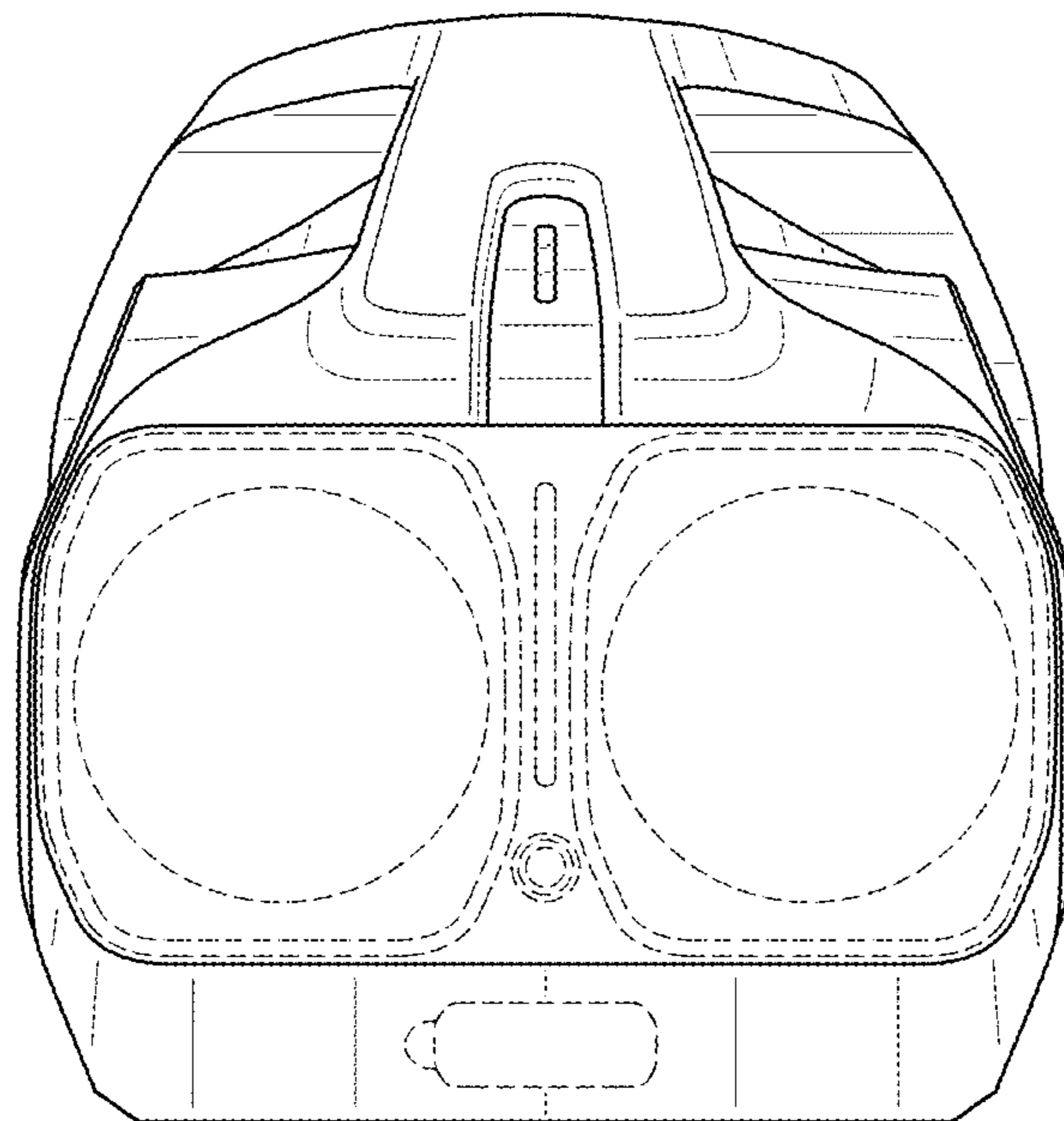

FIG. 8