



US00D908834S

(12) **United States Design Patent**
Cho et al.

(10) **Patent No.:** **US D908,834 S**

(45) **Date of Patent:** **** Jan. 26, 2021**

(54) **WATER PURIFIER**

(71) Applicant: **LG ELECTRONICS INC.**, Seoul (KR)

(72) Inventors: **Najung Cho**, Seoul (KR); **Sookyung Kang**, Seoul (KR); **Kyukwan Choi**, Seoul (KR); **Hyoungwon Roh**, Seoul (KR)

(73) Assignee: **LG Electronics Inc.**, Seoul (KR)

(**) Term: **15 Years**

(21) Appl. No.: **35/508,173**

(22) Filed: **Jun. 20, 2019**

(80) **Hague Agreement Data**

Int. Filing Date: **Jun. 20, 2019**

Int. Reg. No.: **DM/203787**

Int. Reg. Date: **Jun. 20, 2019**

Int. Reg. Pub. Date: **Dec. 20, 2019**

(30) **Foreign Application Priority Data**

Jan. 10, 2019 (KR) 30-2019-0001495

(51) **LOC (13) Cl.** **23-01**

(52) **U.S. Cl.**
USPC **D23/207**

(58) **Field of Classification Search**
USPC D23/200, 206, 207, 209; D15/79, 81;
D7/306, 309
CPC .. F25C 5/002; F25C 5/005; F25C 5/12; F25C
1/04; F25C 2700/02; F25C 5/046; F25C
5/187

See application file for complete search history.

(56) **References Cited**

U.S. PATENT DOCUMENTS

D355,241 S *	2/1995	Zylstra	C02F 1/001 D23/209
D678,979 S *	3/2013	Liu	D23/207
D741,982 S *	10/2015	Maeng	D23/207
D764,014 S *	8/2016	Lin	D23/207
D825,027 S *	8/2018	He	D23/207
D872,225 S *	1/2020	Joo	D23/207
D878,518 S *	3/2020	Erdwiens	D23/209
D900,960 S *	11/2020	Lee	D23/207
2019/0382281 A1 *	12/2019	Moon	C02F 1/001

* cited by examiner

Primary Examiner — Keli L Hill

(74) *Attorney, Agent, or Firm* — Birch, Stewart, Kolasch & Birch, LLP

(57) **CLAIM**

The ornamental design for a water purifier, as shown and described.

DESCRIPTION

- 1. Water purifier
- 1.1 : Perspective
- 1.2 : Front
- 1.3 : Back
- 1.4 : Left
- 1.5 : Right
- 1.6 : Top
- 1.7 : Bottom
- 1.8 : Unfolded

1 Claim, 8 Drawing Sheets

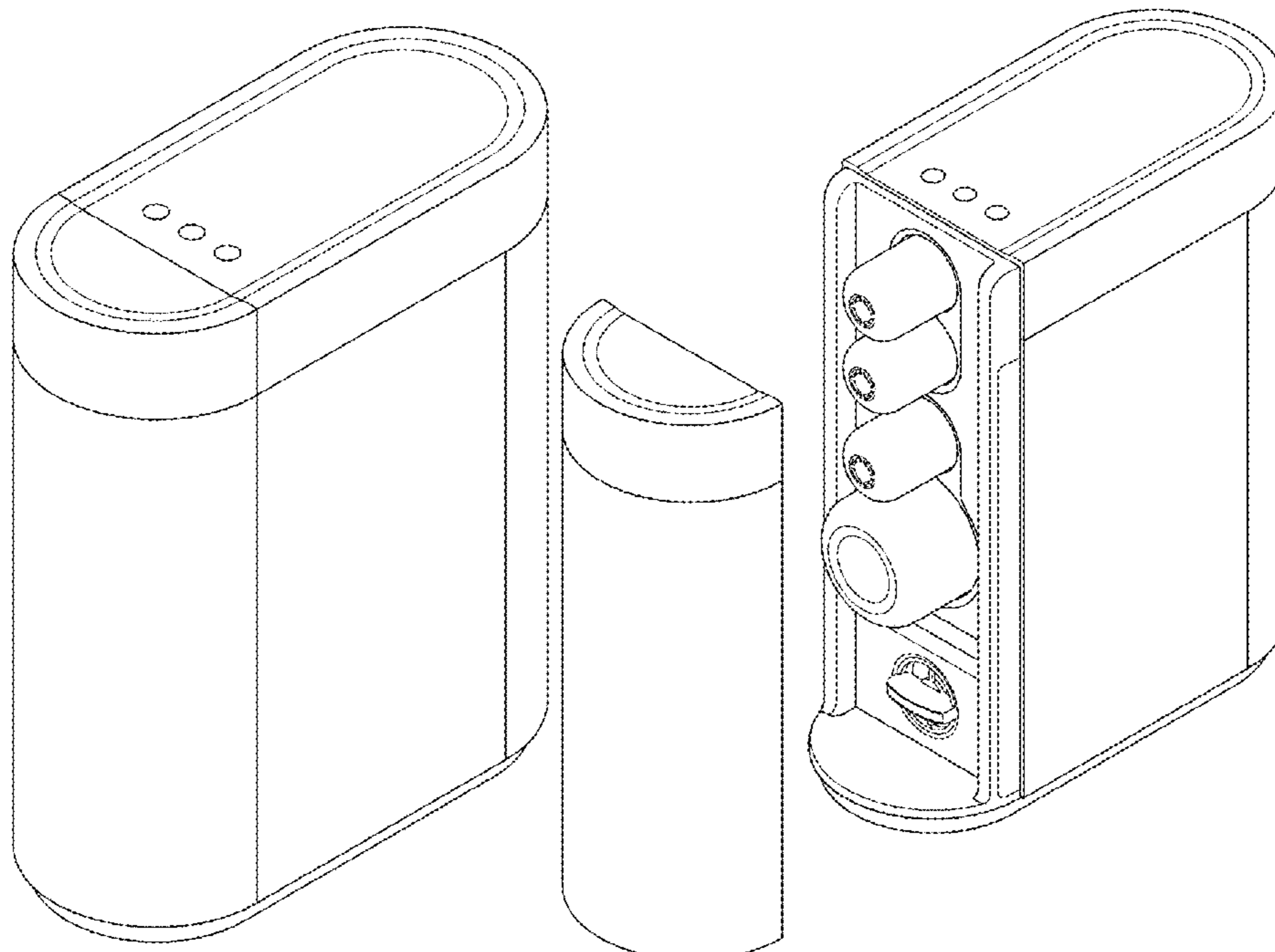

1.1

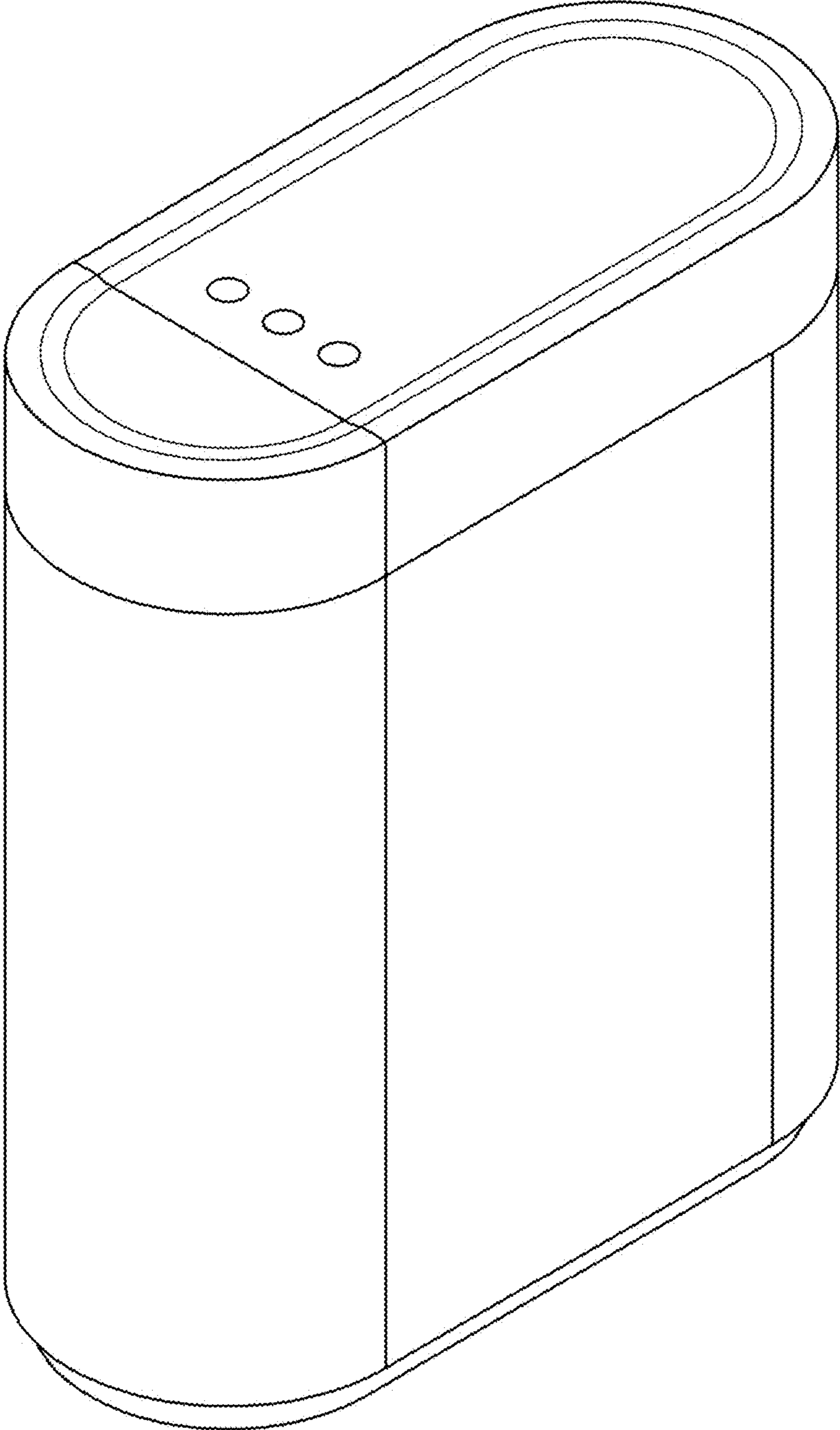

1.2

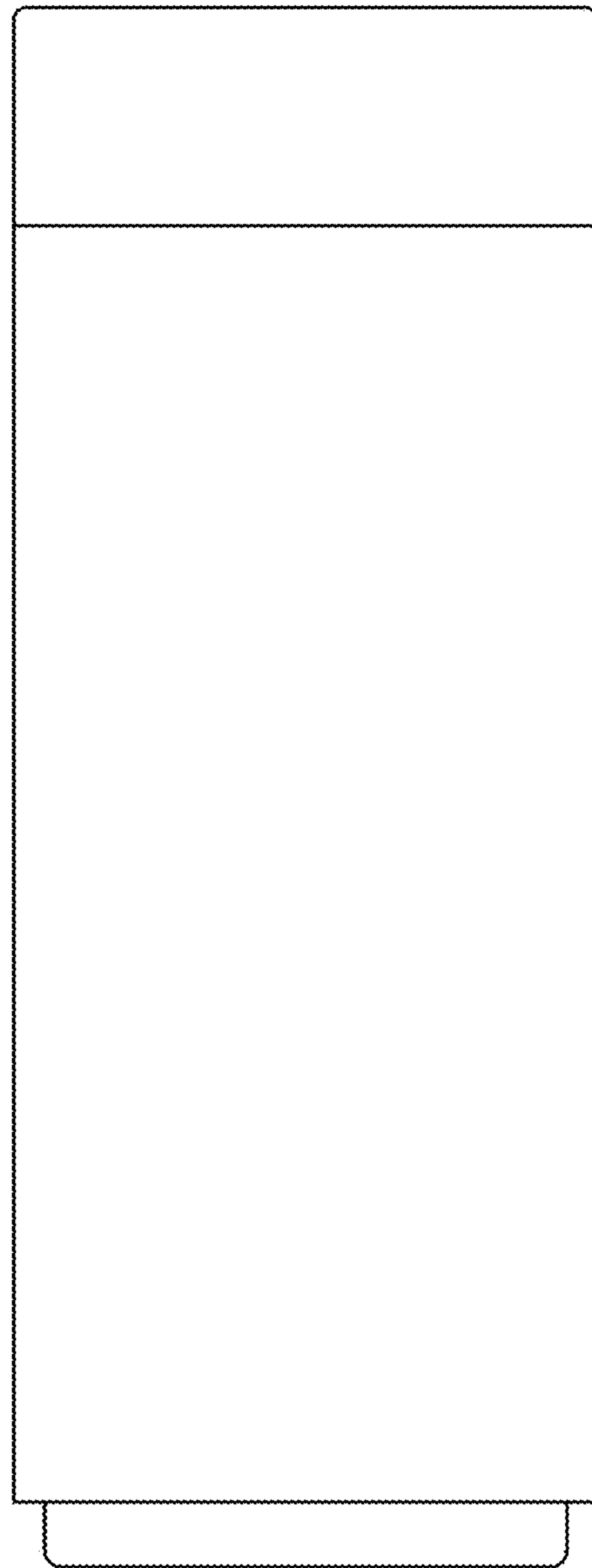

1.3

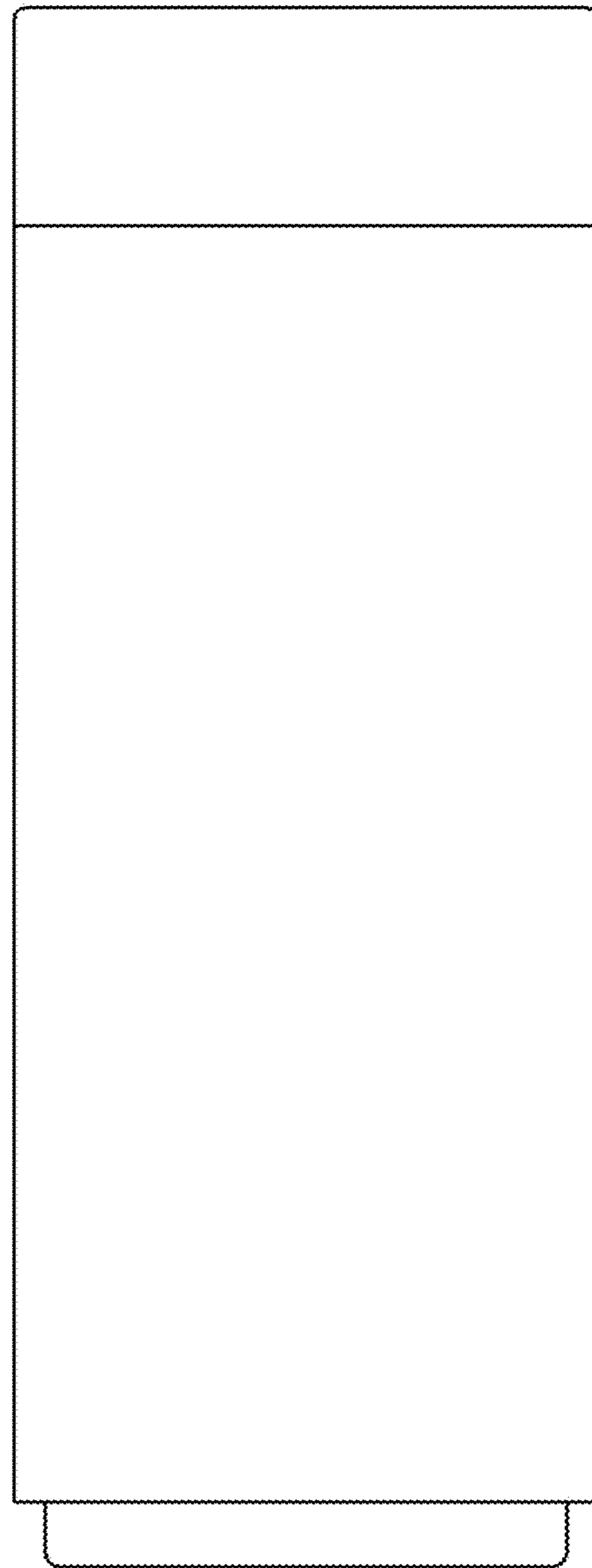

1.4

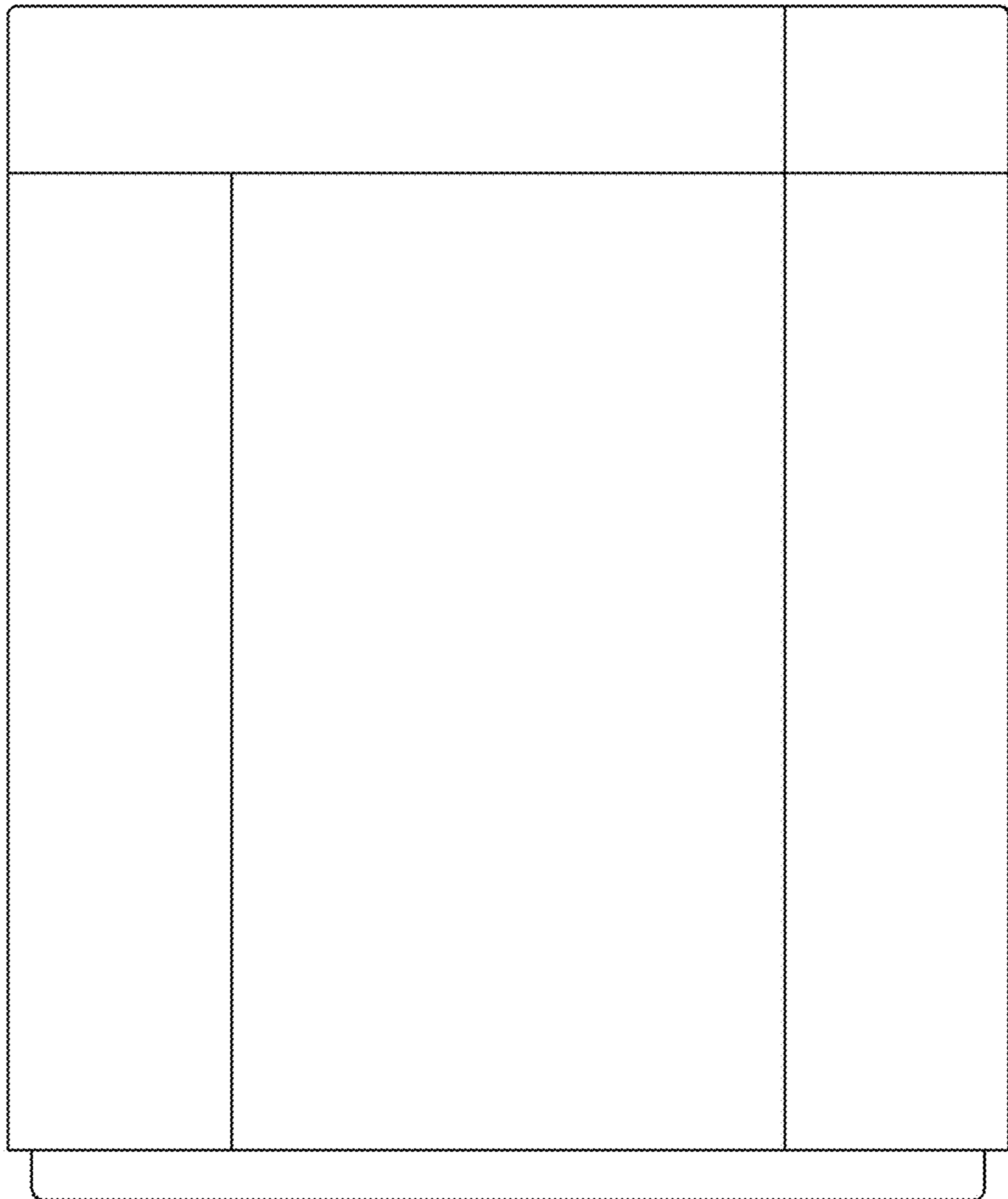

1.5

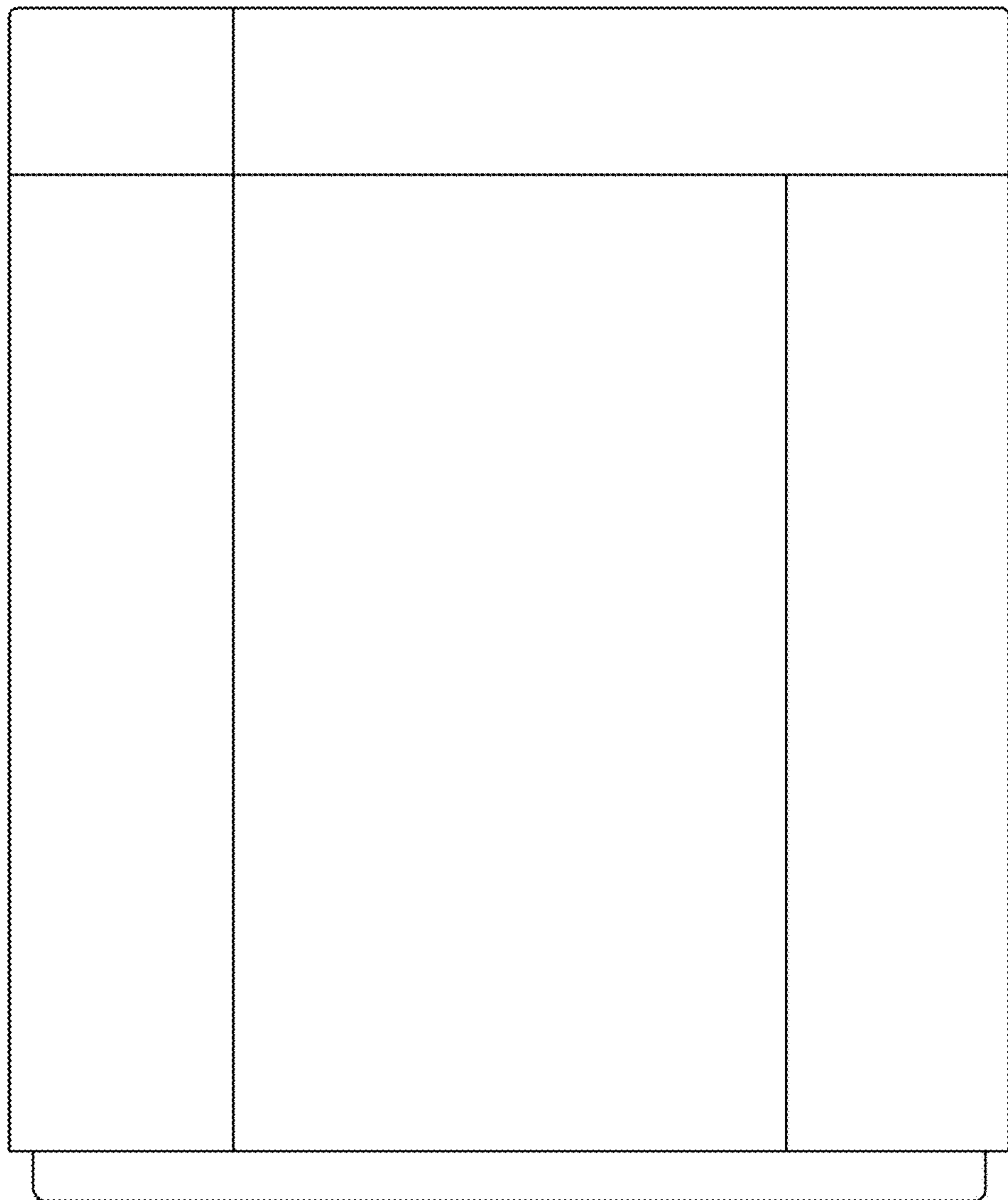

1.6

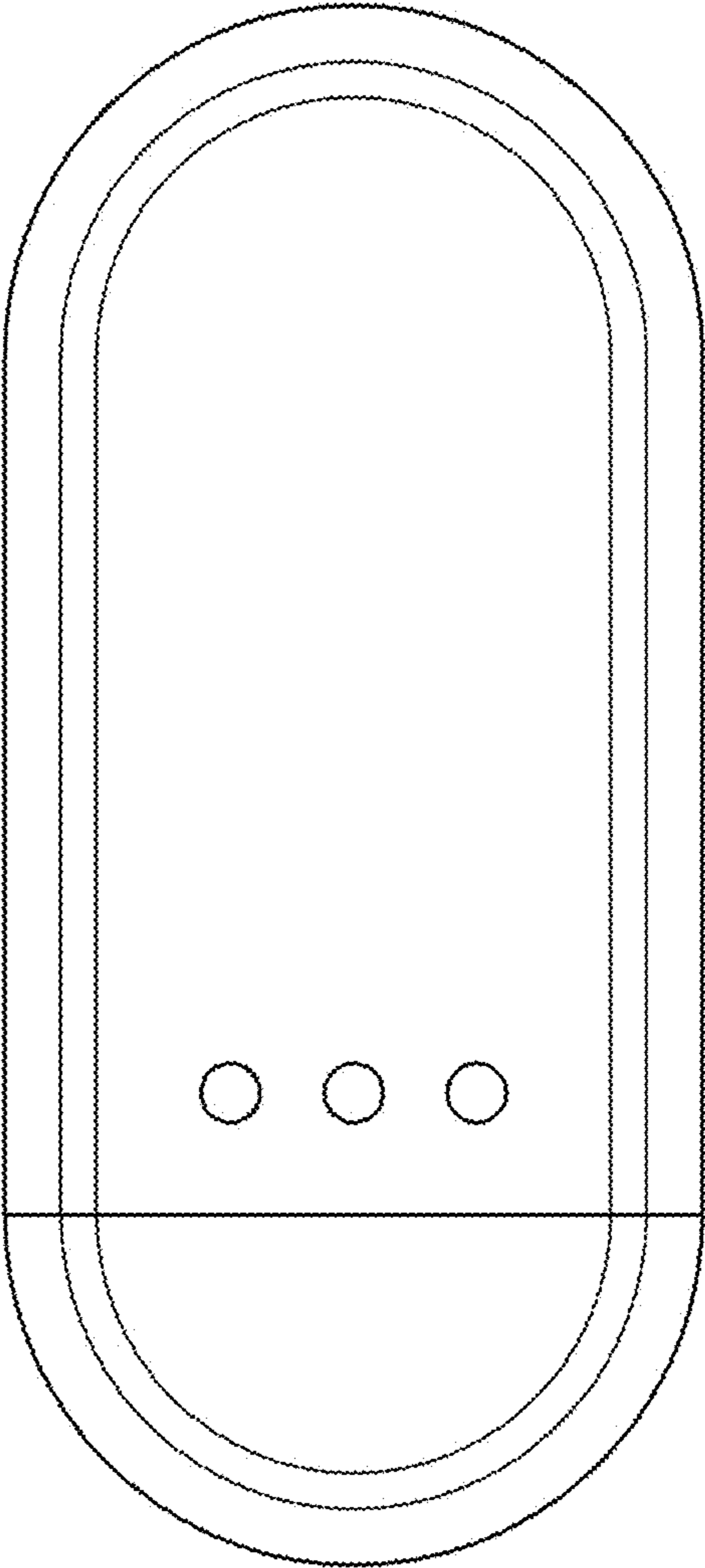

1.7

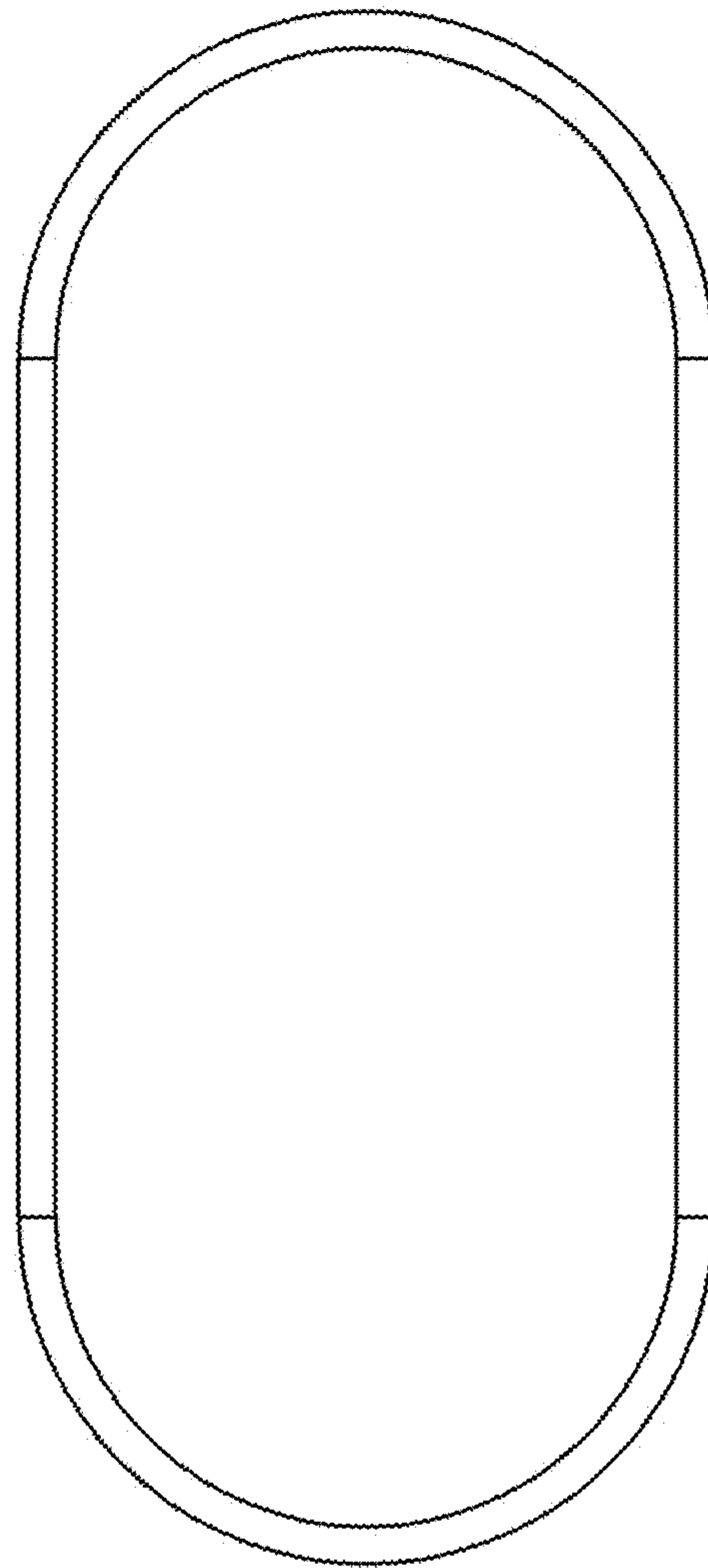

1.8

