



US00D908695S

(12) **United States Design Patent**
Nokuo

(10) **Patent No.:** **US D908,695 S**

(45) **Date of Patent:** **** Jan. 26, 2021**

(54) **HEAD-MOUNTED DISPLAY**

FOREIGN PATENT DOCUMENTS

(71) Applicant: **SONY INTERACTIVE ENTERTAINMENT INC.**, Tokyo (JP)

CO 15-200166 9/2015
IL 56064 9/2014

(Continued)

(72) Inventor: **Taichi Nokuo**, Tokyo (JP)

OTHER PUBLICATIONS

(73) Assignee: **SONY INTERACTIVE ENTERTAINMENT INC.**, Tokyo (JP)

Colombian Office Action for Application No. NC2018/0003171, dated Jul. 24, 2018.

(Continued)

(**) Term: **15 Years**

Primary Examiner — Austin Murphy

(21) Appl. No.: **29/641,693**

(74) *Attorney, Agent, or Firm* — Nixon & Vanderhye

(22) Filed: **Mar. 23, 2018**

(57) **CLAIM**

The ornamental design for a head-mounted display, as shown and described.

(30) **Foreign Application Priority Data**

DESCRIPTION

Sep. 25, 2017 (JP) 2017-020863

(51) **LOC (13) Cl.** **14-02**

(52) **U.S. Cl.**
USPC **D14/372**

(58) **Field of Classification Search**
USPC D14/372, 496, 432, 371, 125, 126, 129, D14/299; D16/300-342; 351/158, 153, 351/144; 345/7-9, 905; 455/344; 348/115, 53, 121, 739

CPC G02B 27/017; G02B 27/0158; G02B 27/0161; G02B 27/0181; G02B 27/0185; G02B 27/0189

See application file for complete search history.

FIG. 1 is a perspective view of front, top and right side of a head-mounted display showing my new design;
FIG. 2 is a perspective view of rear, top and right side thereof;
FIG. 3 is a perspective view of front, bottom and right side thereof;
FIG. 4 is a front view thereof;
FIG. 5 is a rear view thereof;
FIG. 6 is a left side view thereof;
FIG. 7 is a right side view thereof;
FIG. 8 is a top view thereof;
FIG. 9 is a bottom view thereof;
FIG. 10 is a partially enlarged view at the portion 10 of FIG. 2 thereof;
FIG. 11 is a partially enlarged view at the portion 11 of FIG. 7 thereof;
FIG. 12 is a reference view 1 of usage thereof; and,
FIG. 13 is a reference view 2 of usage thereof.
The portions of the article in broken lines are shown for illustrative purposes only and form no part of the claimed design.

(56) **References Cited**

U.S. PATENT DOCUMENTS

2,458,409 A * 1/1949 Paige H02G 3/065
285/154.1
D344,033 S * 2/1994 Davidge D10/106.9
5,699,591 A * 12/1997 Kane E05B 73/0005
24/114.6

(Continued)

1 Claim, 13 Drawing Sheets

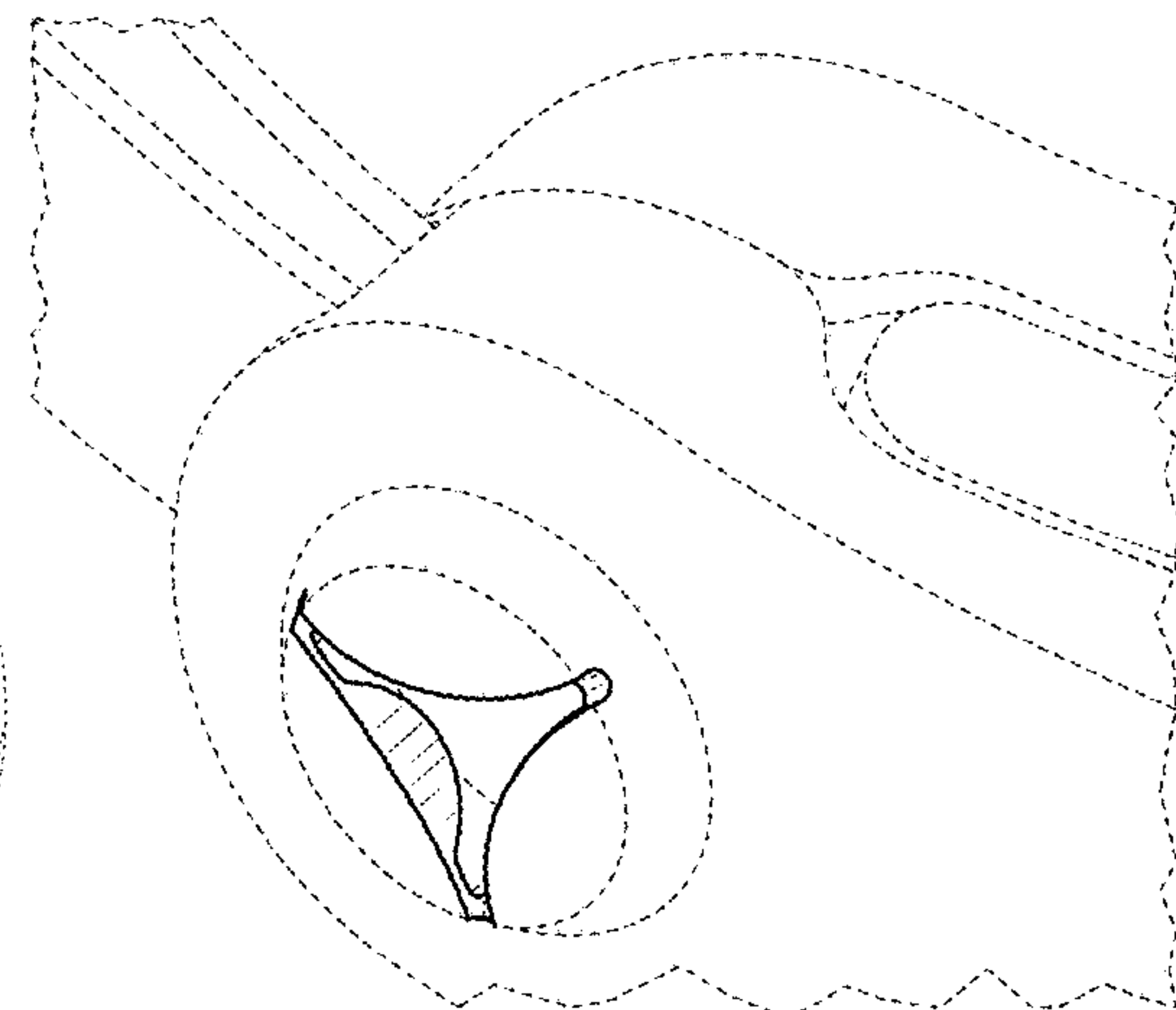
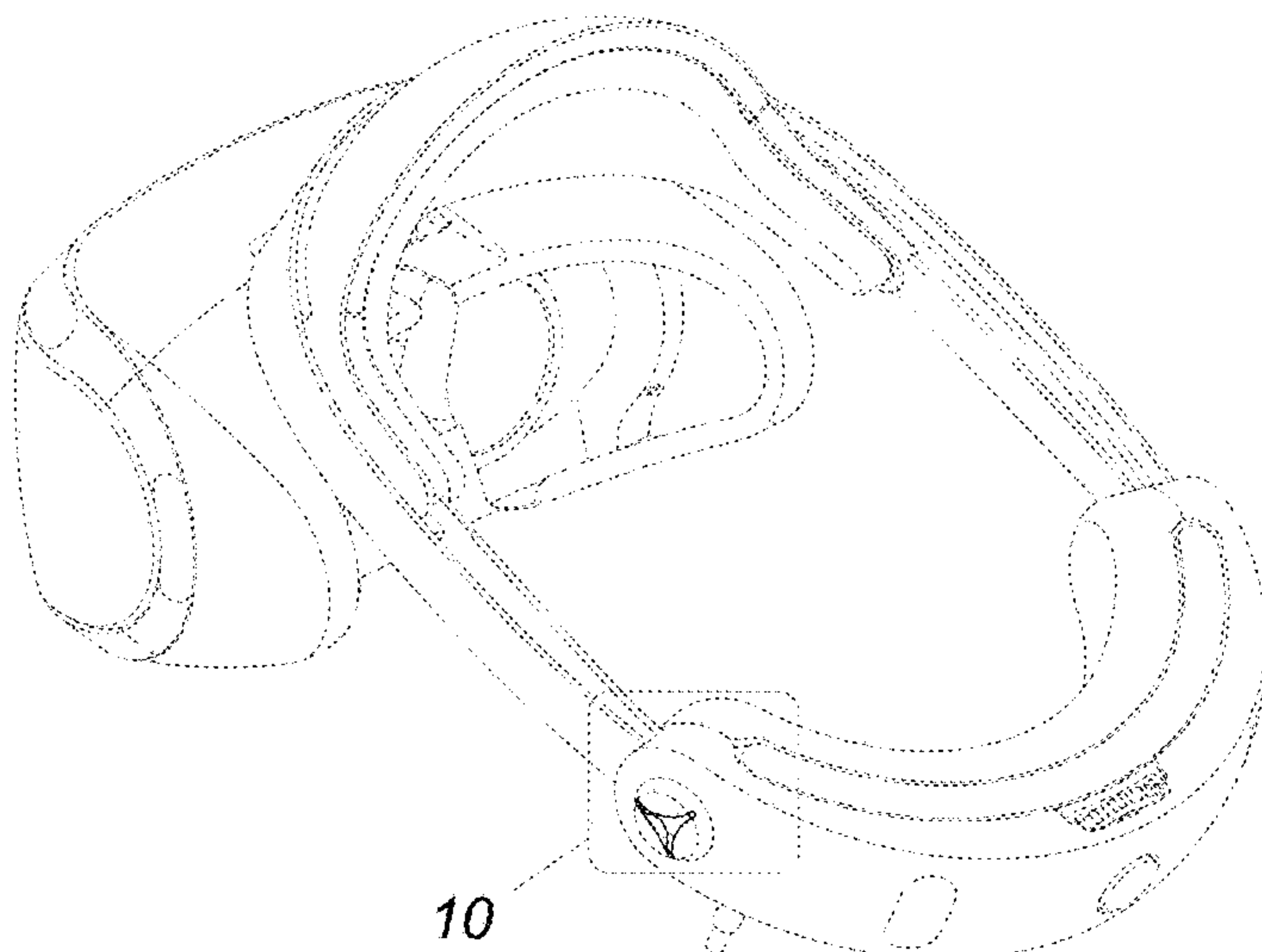

(56)

References Cited

U.S. PATENT DOCUMENTS

6,431,500 B1 * 8/2002 Jacobs F16L 3/13
24/129 R
D677,219 S * 3/2013 Nokuo D13/108
D685,771 S * 7/2013 Bertenthal D14/223
D811,858 S * 3/2018 Martino D8/356
D812,692 S * 3/2018 Nokuo D21/333
D825,531 S * 8/2018 Nokuo D14/218
D842,078 S * 3/2019 Martino D8/356
D860,173 S * 9/2019 Nokuo D14/223
D867,859 S * 11/2019 Herbert D8/356

FOREIGN PATENT DOCUMENTS

IL 57330 8/2015
TH 158096 11/2016
VN 3-2015-23153 10/2015

OTHER PUBLICATIONS

Vietnam Official Action—3-2018-00524—dated Mar. 18, 2019.
Israeli Office Action for Design Application No. 61815, dated Dec.
25, 2018, with English translation provided.
Israeli Office Action for Design Application No. 61815, dated Apr.
14, 2019, with English translation provided.
Thai Office Action for Design Application No. 1802001217, dated
Jun. 19, 2020, with English translation provided.

* cited by examiner

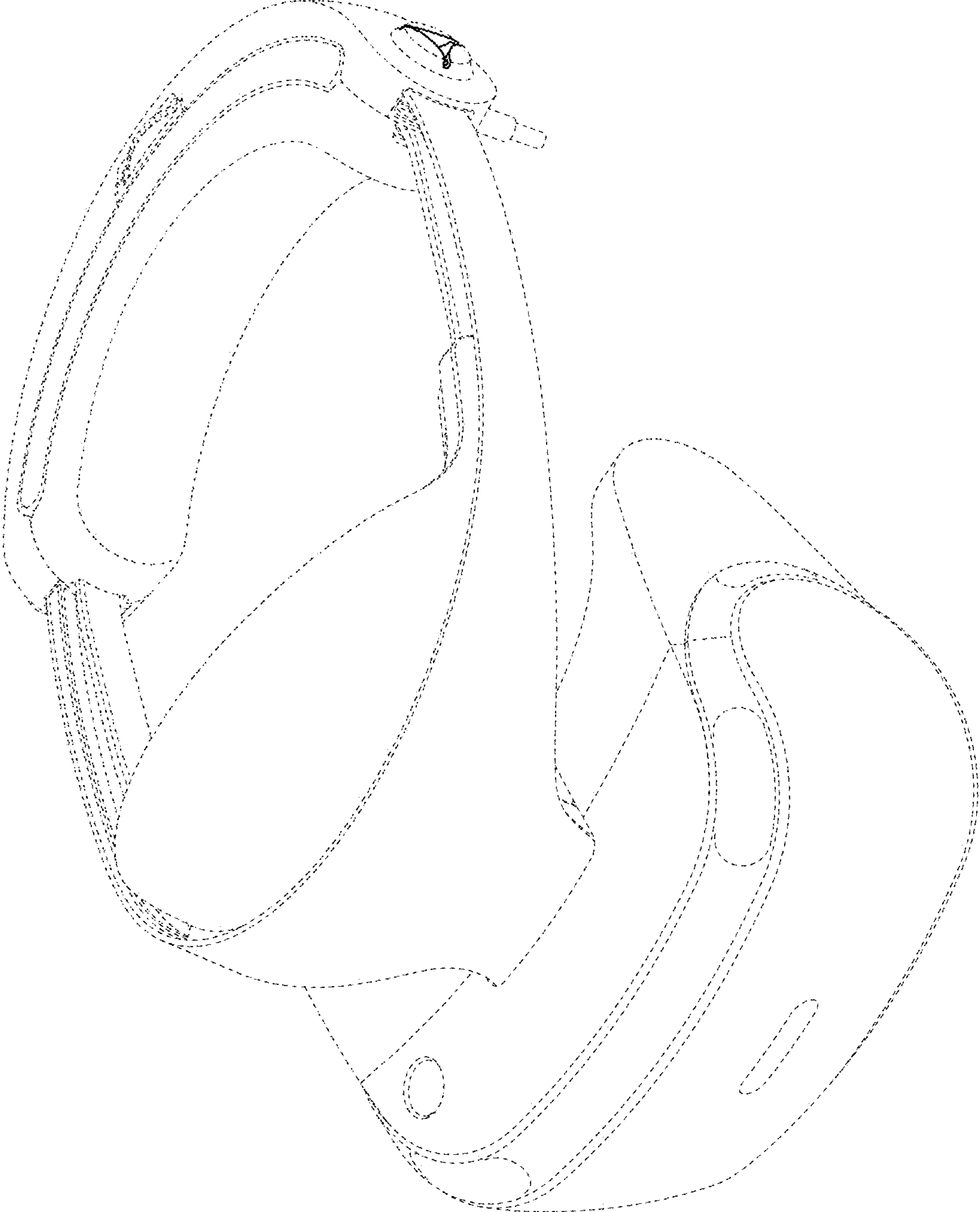

FIG. 1

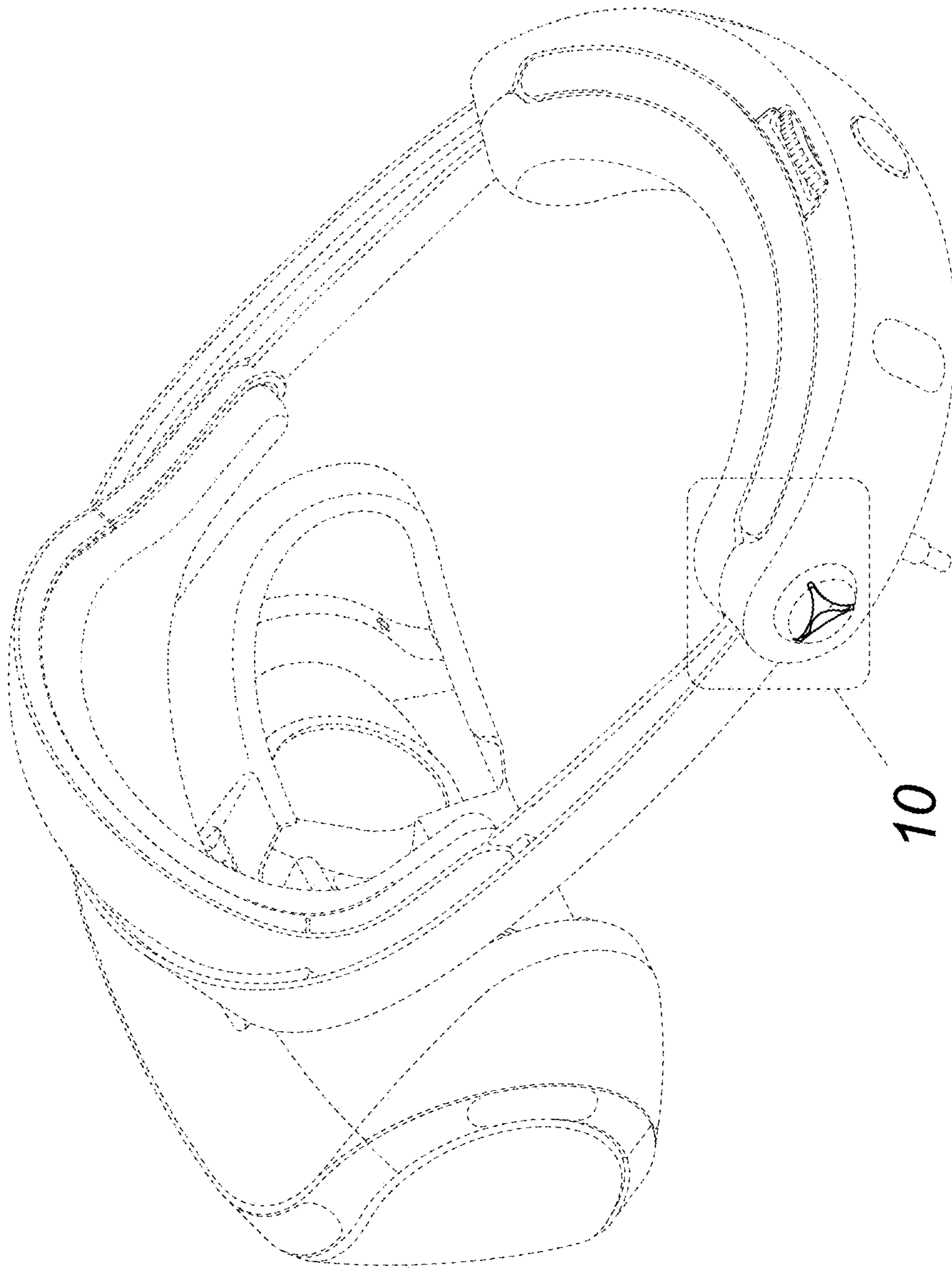

FIG. 2

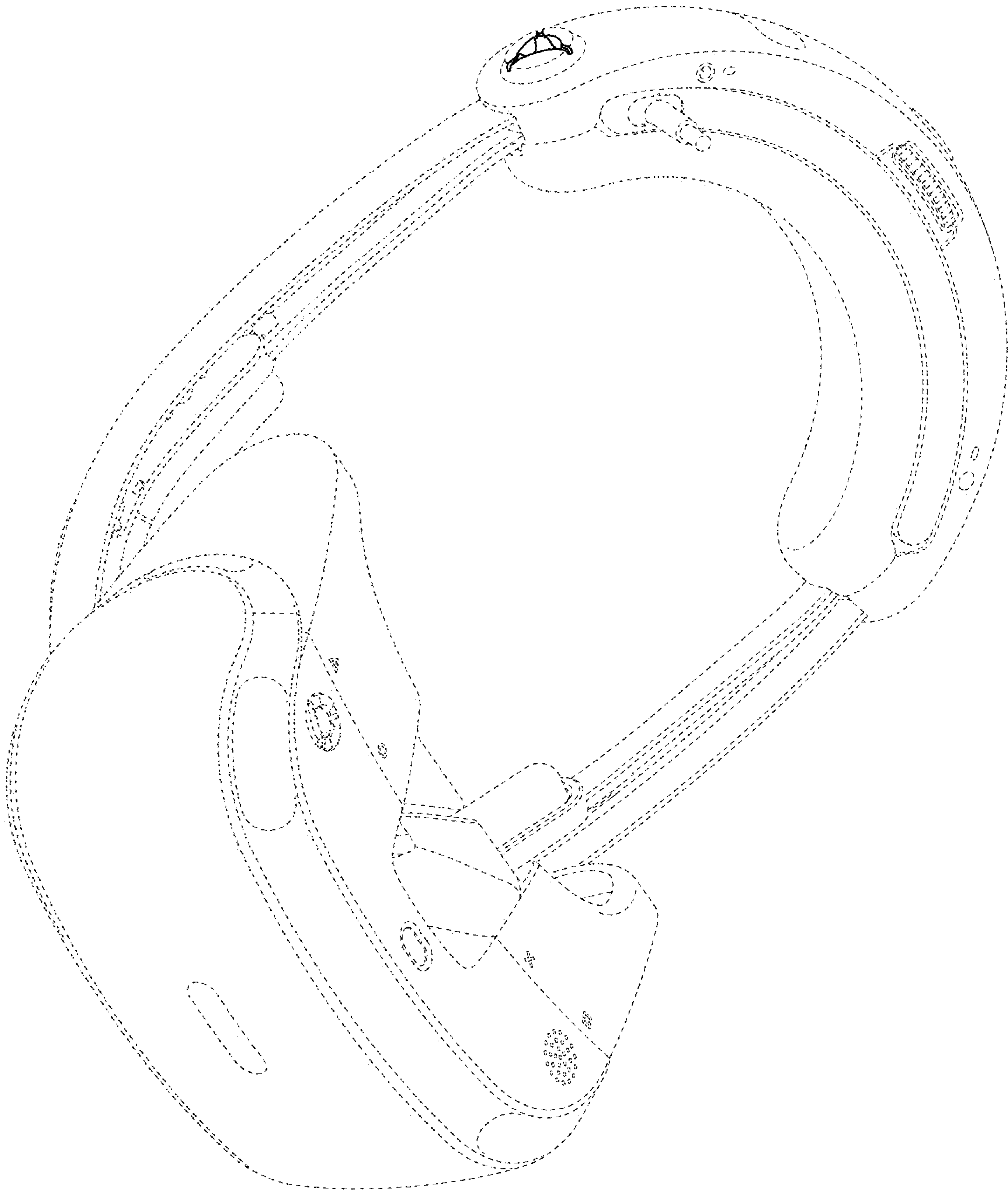

FIG. 3

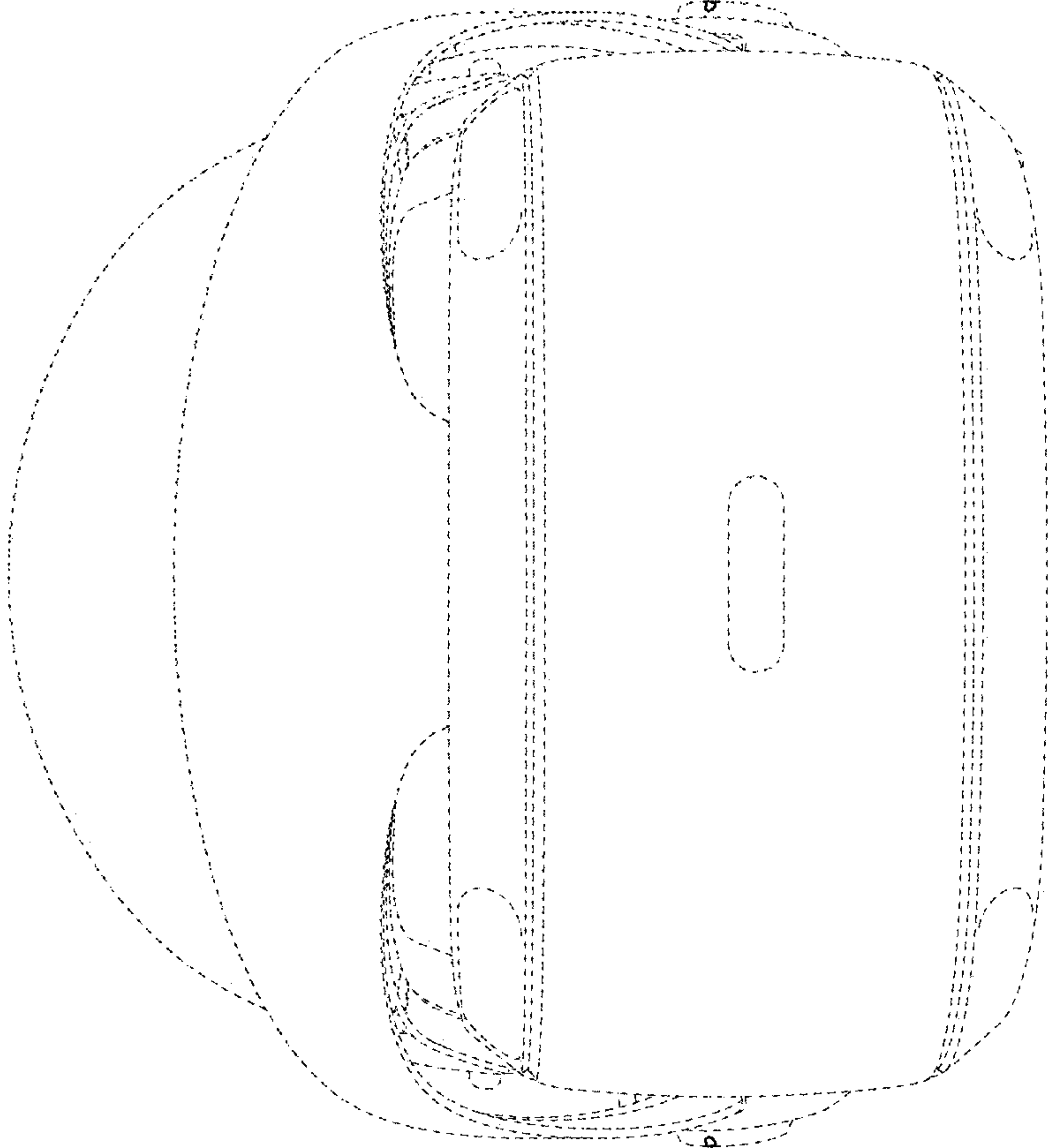

FIG. 4

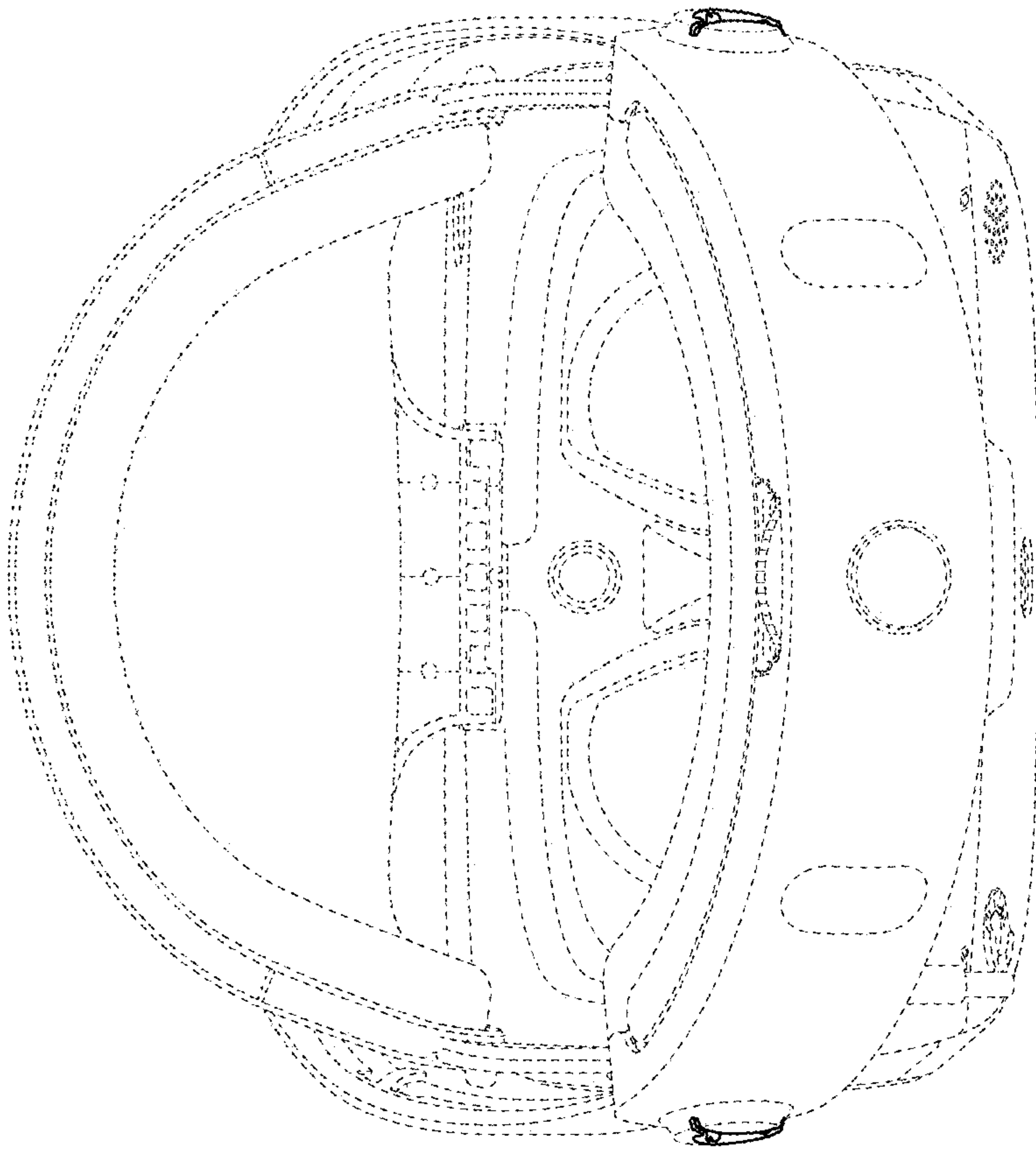

FIG. 5

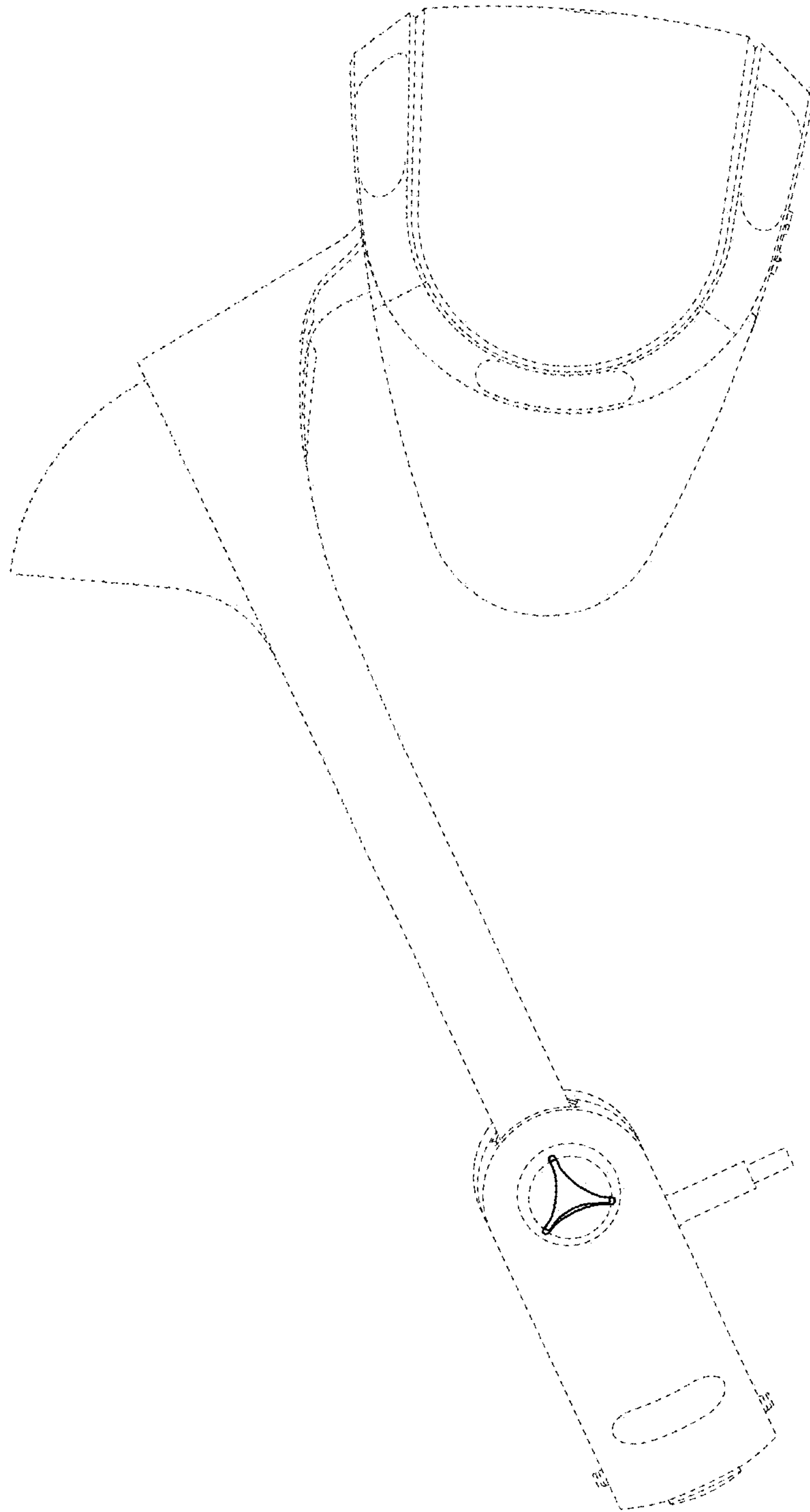

FIG. 6

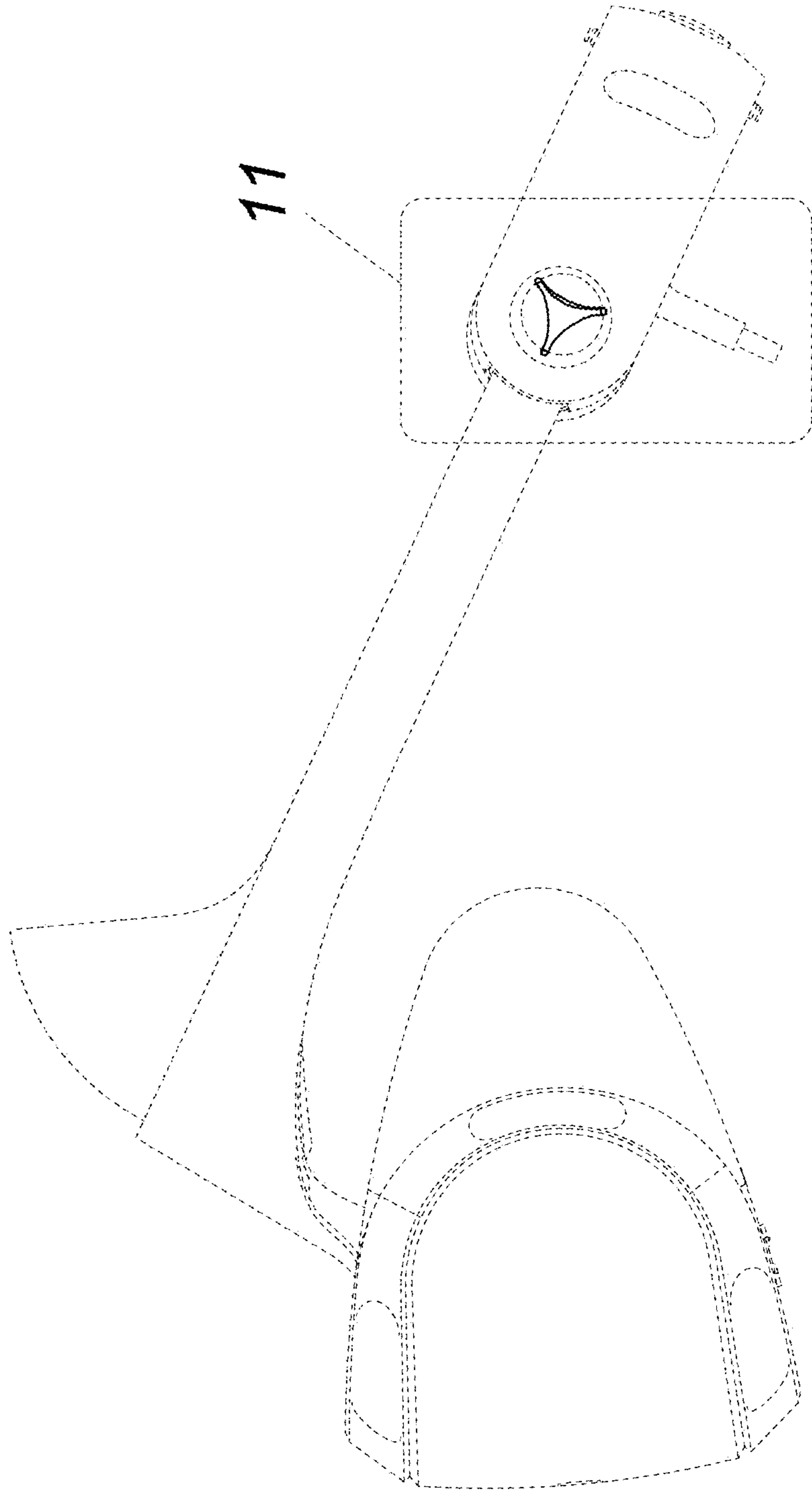

FIG. 7

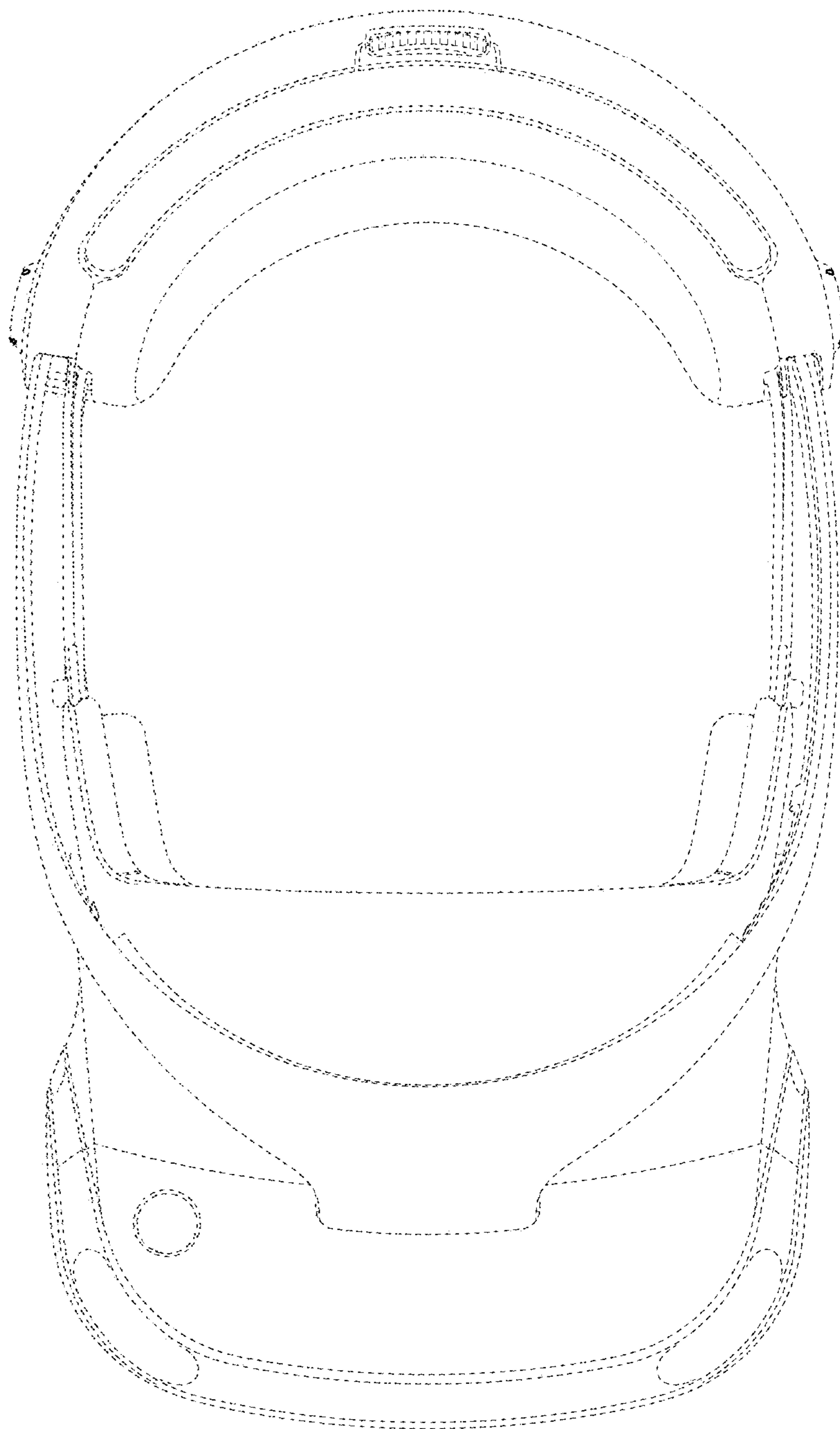

FIG. 8

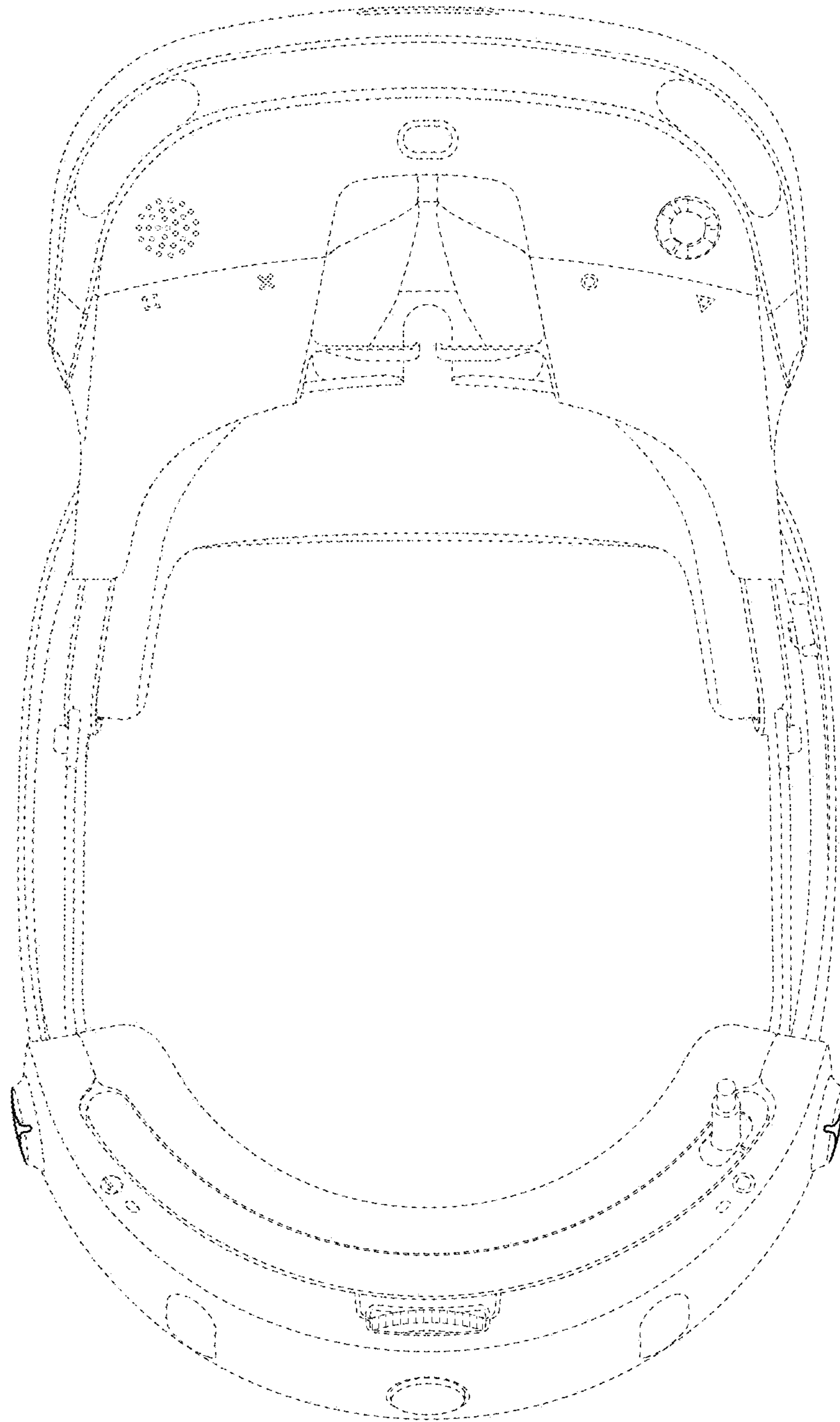

FIG. 9

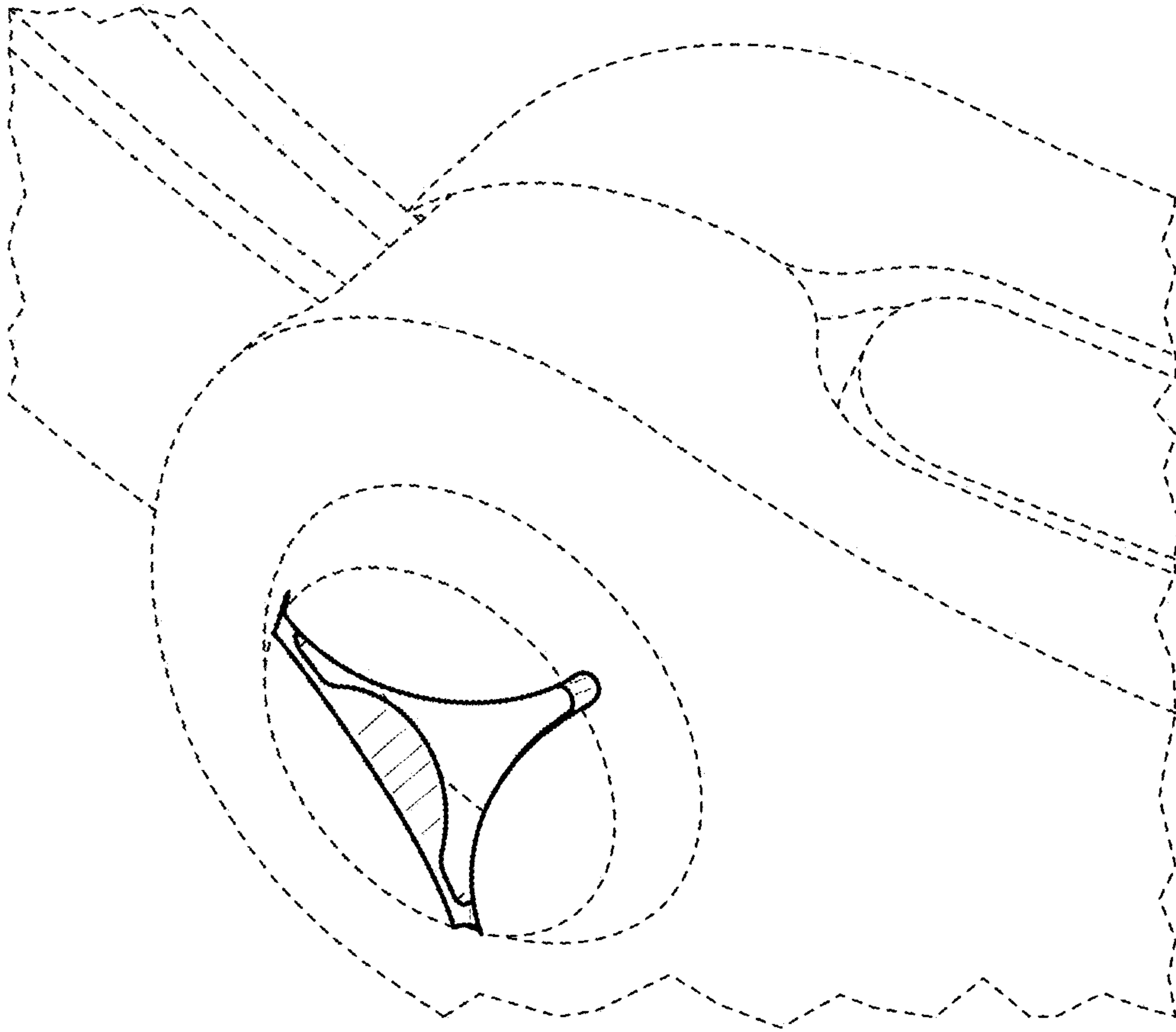

FIG. 10

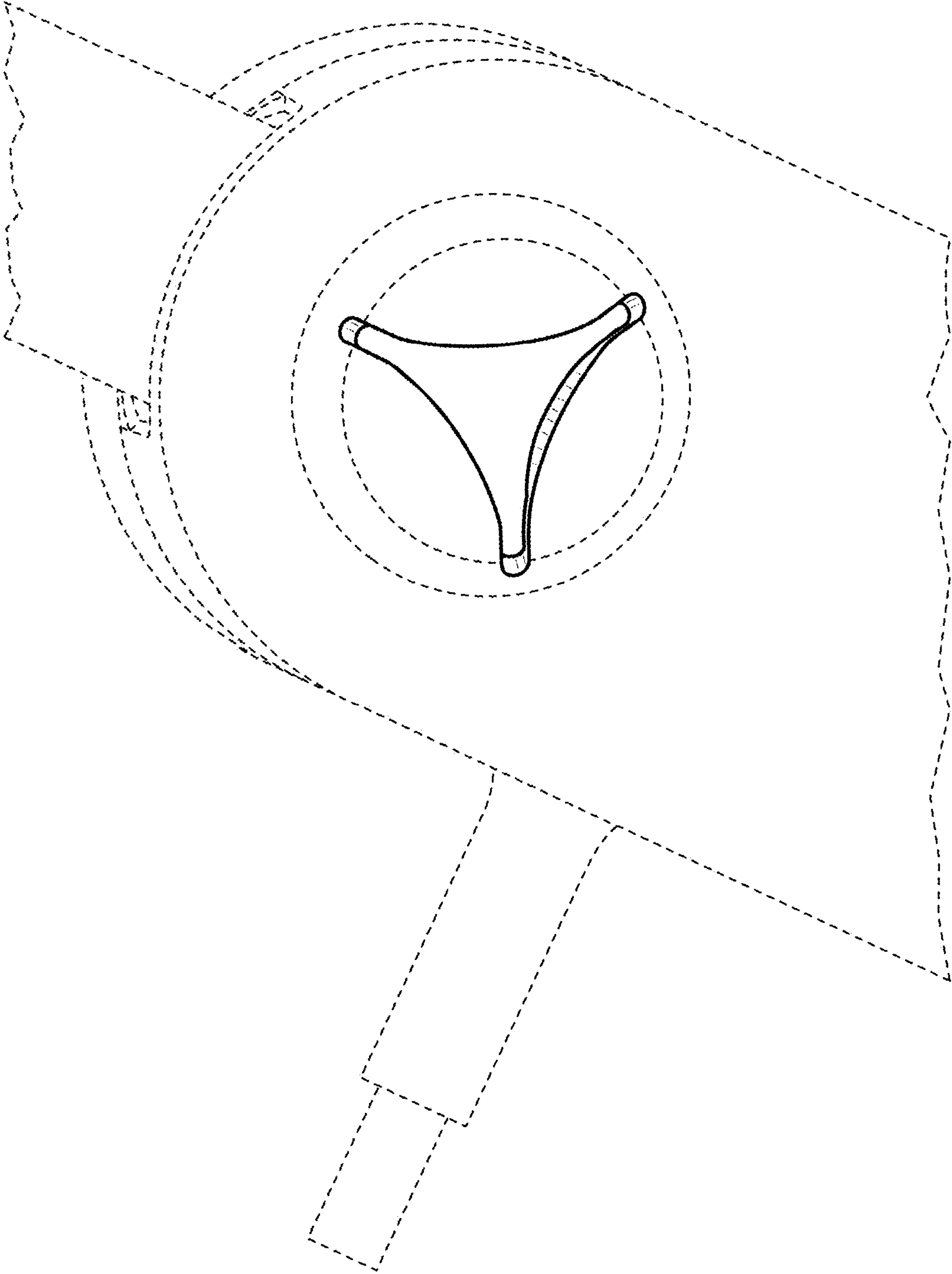

FIG. 11

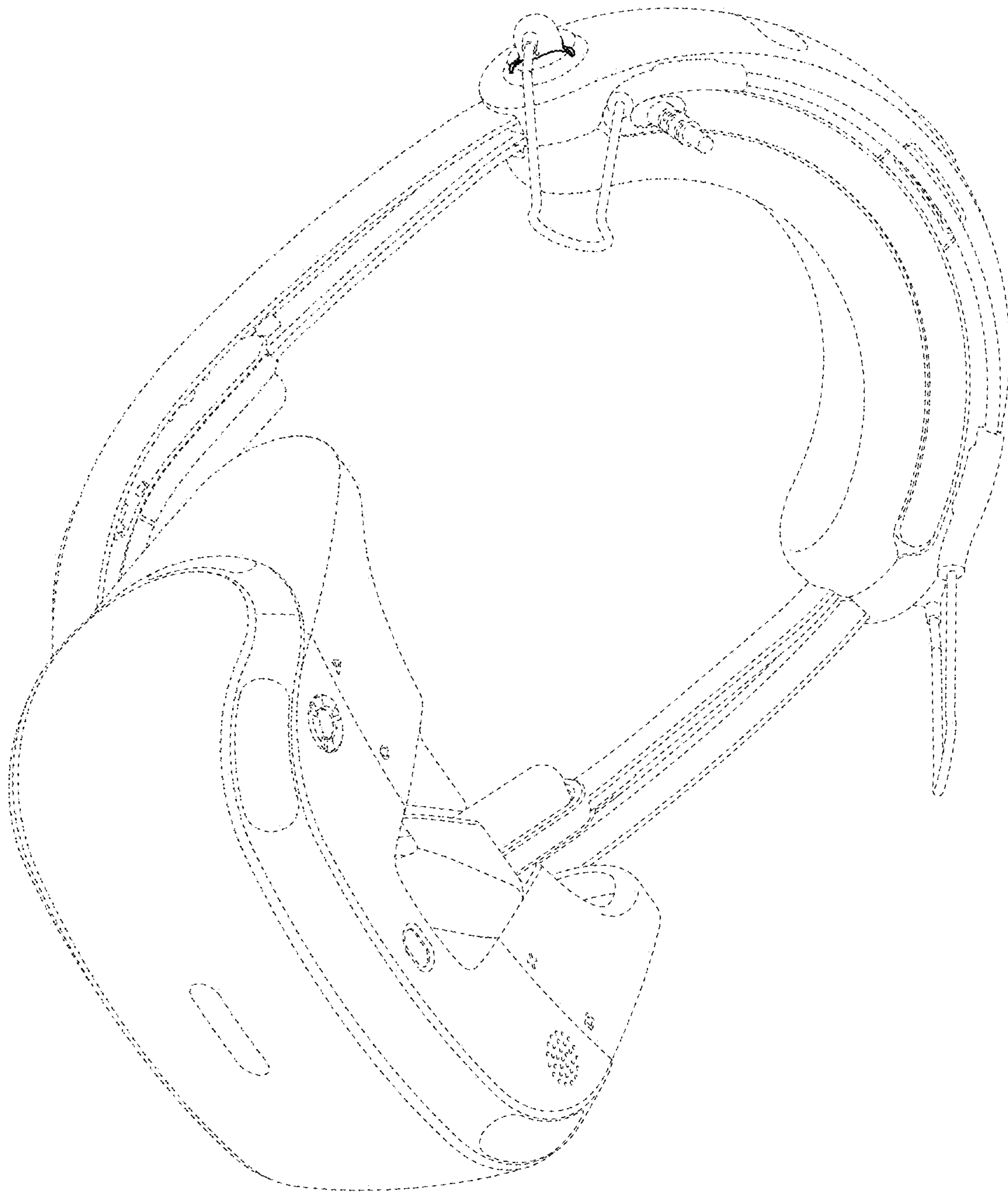

FIG. 12

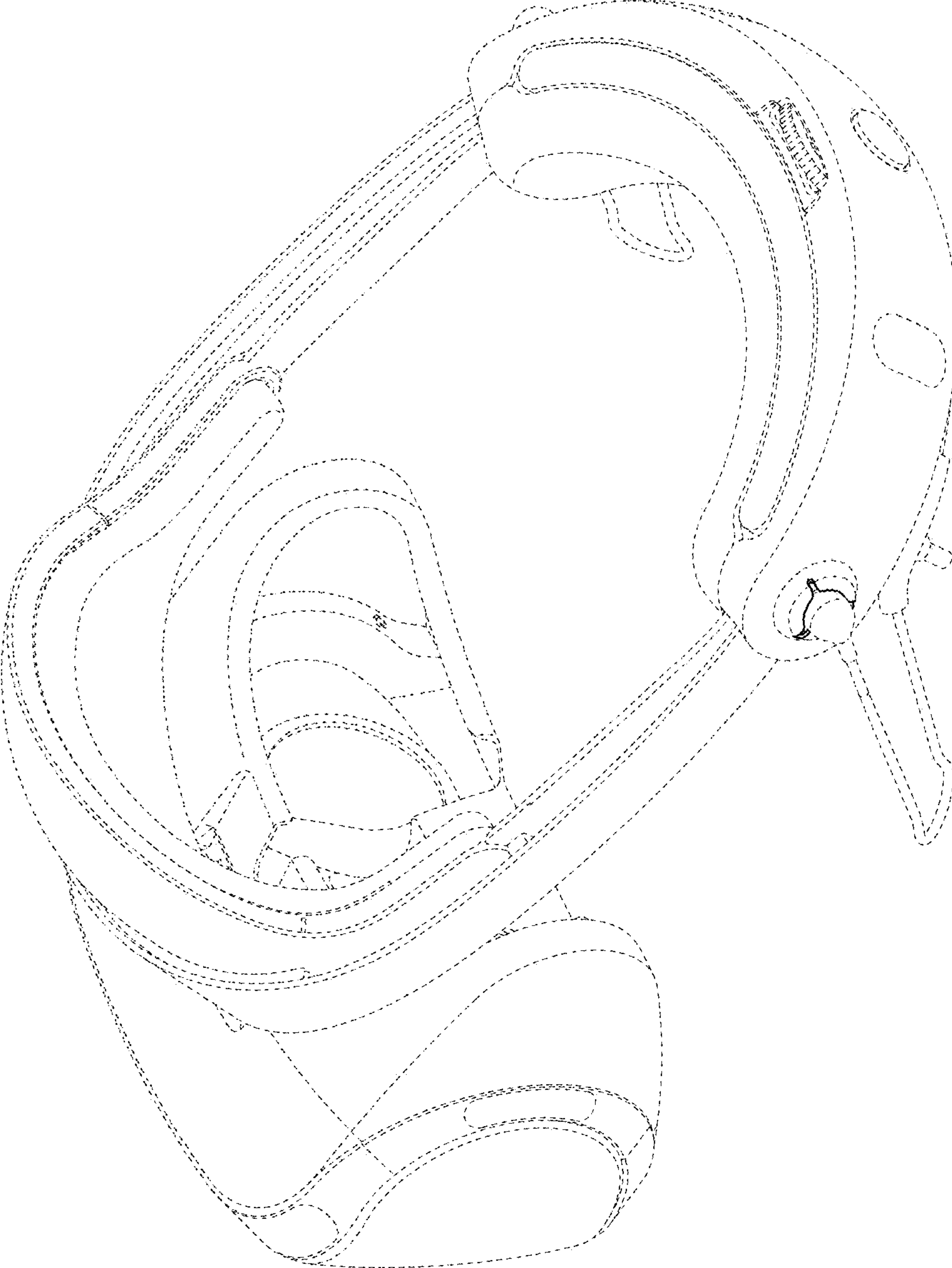

FIG. 13