



US00D908681S

(12) **United States Design Patent** (10) **Patent No.:** **US D908,681 S**  
**Coverstone et al.** (45) **Date of Patent:** **\*\* Jan. 26, 2021**

- (54) **CASE FOR MOBILE PHONE**
- (71) Applicant: **STAR CO Scientific Technologies Advanced Research Co, LLC**, Longview, TX (US)
- (72) Inventors: **Thomas E. Coverstone**, Longview, TX (US); **Jason Montgomery**, Longview, TX (US); **Taylor Buscher**, Longview, TX (US); **Jarmo Ikonen**, Lahti (FI)
- (73) Assignee: **STAR CO SCIENTIFIC TECHNOLOGIES ADVANCED RESEARCH CO, LLC**, Longview, TX (US)
- (\*\*) Term: **15 Years**
- (21) Appl. No.: **29/703,446**
- (22) Filed: **Aug. 27, 2019**
- (51) **LOC (13) Cl.** ..... **14-03**
- (52) **U.S. Cl.**  
USPC ..... **D14/250; D13/103**
- (58) **Field of Classification Search**  
USPC .... D14/217, 238.1, 240, 248, 250, 251–253, D14/439, 440, 447; D13/107–108, 103, D13/119; D3/201, 218, 247, 269, 273, D3/301, 303  
CPC ..... H04B 1/3888; H04M 1/0283; H04M 1/0202; A45C 1/06; A45C 11/00; A45C 13/02; A45C 2011/002; A45F 2005/026; A45F 2200/0525; A45F 2200/0516  
See application file for complete search history.

- D756,911 S \* 5/2016 Gupta ..... D13/103
- D759,585 S \* 6/2016 Herbst ..... D13/103
- D788,759 S \* 6/2017 Akana ..... D14/250
- D789,346 S \* 6/2017 Akana ..... D14/250
- 9,721,077 B1 \* 8/2017 Daniel ..... G06F 21/86
- D797,091 S \* 9/2017 To ..... D14/250
- D797,093 S \* 9/2017 To ..... D14/250
- D819,620 S \* 6/2018 Parker ..... D14/250
- 10,063,270 B2 \* 8/2018 Coulter ..... H04B 1/036
- 10,069,529 B2 \* 9/2018 Jeon ..... H02J 7/025

(Continued)

**OTHER PUBLICATIONS**

“Mophie Juice Pack Access—Ultra-Slim Wireless Charging Battery Case [ . . . ]” [online]. Mophie. [Date first available on Oct. 28, 2019]. Retrieved from the Internet: <<https://www.amazon.com/dp/B07Z9V21SP/>>.\*

*Primary Examiner* — Khawaja Anwar  
*Assistant Examiner* — Mojtaba Tehrani  
(74) *Attorney, Agent, or Firm* — McAndrews, Held & Malloy, Ltd.

(57) **CLAIM**

The ornamental design for a case for mobile phone, as shown and described.

**DESCRIPTION**

FIG. 1 is a front perspective view of a case for mobile phone showing our new design;  
FIG. 2 is a front elevation view thereof;  
FIG. 3 is a rear elevation view thereof;  
FIG. 4 is a right side elevation view thereof;  
FIG. 5 is a left side elevation view thereof;  
FIG. 6 is a top plan view thereof;  
FIG. 7 is a bottom plan view thereof; and,  
FIG. 8 is a rear perspective view thereof.  
The dashed broken lines in the figures depict portions of the case for mobile phone that form no part of the claimed design.

**1 Claim, 6 Drawing Sheets**

- (56) **References Cited**  
U.S. PATENT DOCUMENTS  
D671,493 S \* 11/2012 Hasbrook ..... D13/119  
D710,795 S \* 8/2014 Gupta ..... D13/103  
D711,863 S \* 8/2014 Wen ..... D14/250  
D756,909 S \* 5/2016 Gupta ..... D13/103  
D756,910 S \* 5/2016 Gupta ..... D13/103

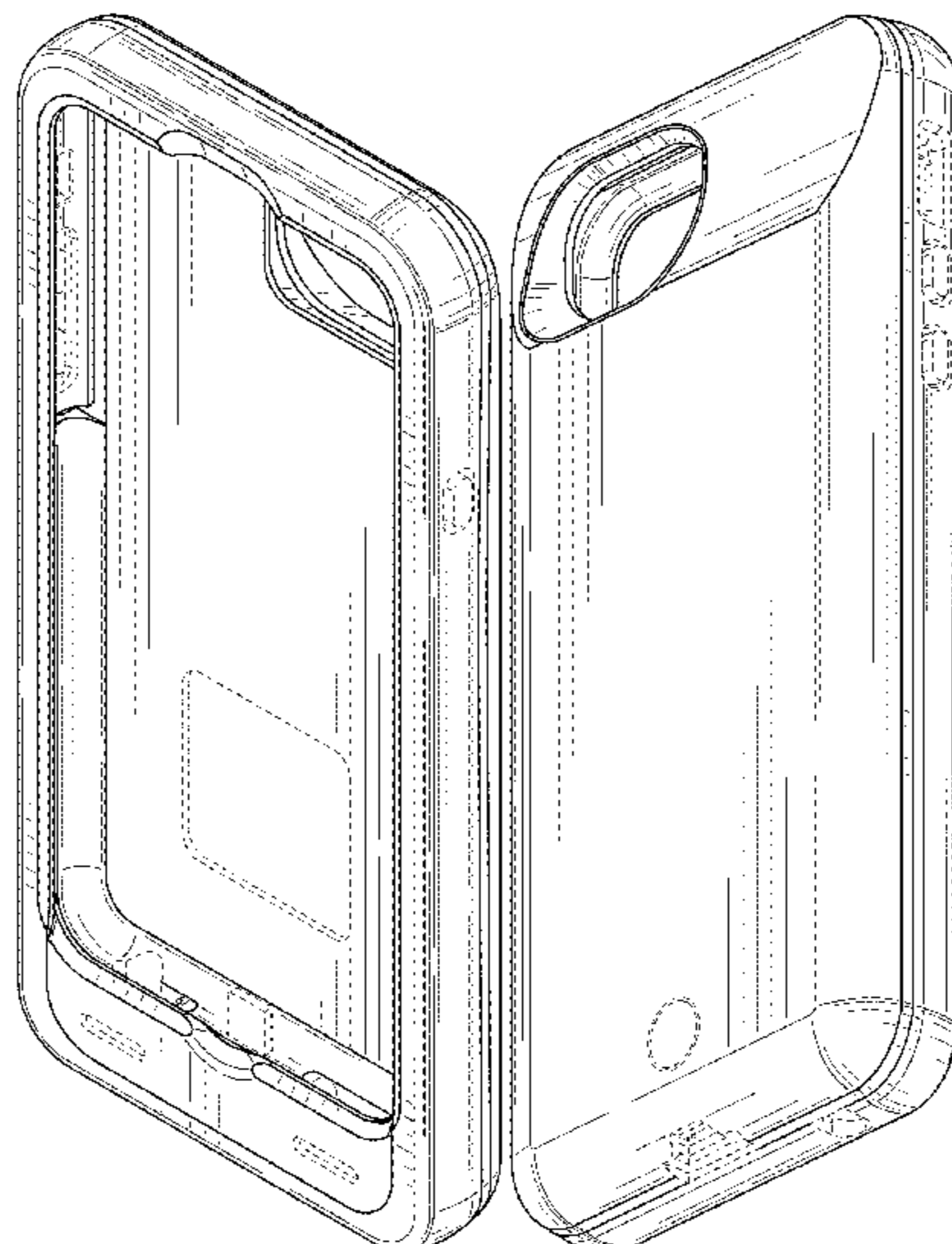

(56)

**References Cited**

U.S. PATENT DOCUMENTS

D831,632 S \* 10/2018 Jung ..... D14/250  
D837,192 S \* 1/2019 Chaney ..... A45C 11/00  
D14/250  
D847,129 S \* 4/2019 To ..... D14/250  
D850,373 S \* 6/2019 Zhang ..... D13/108  
D858,505 S \* 9/2019 Zhang ..... D14/250  
D860,179 S \* 9/2019 Dang ..... D14/250  
D861,653 S \* 10/2019 Gjovik ..... D14/250  
D861,654 S \* 10/2019 Dang ..... D14/250  
D869,453 S \* 12/2019 Wilder ..... D14/250  
D870,091 S \* 12/2019 Chen ..... D14/250  
10,503,205 B2 \* 12/2019 Spevak ..... A45C 11/00  
D883,917 S \* 5/2020 Chen ..... D13/103  
D888,702 S \* 6/2020 Yoon ..... D14/250  
2012/0088558 A1 \* 4/2012 Song ..... H04M 1/18  
455/575.1  
2015/0244407 A1 \* 8/2015 Peral ..... H04B 1/3888  
455/575.8

\* cited by examiner

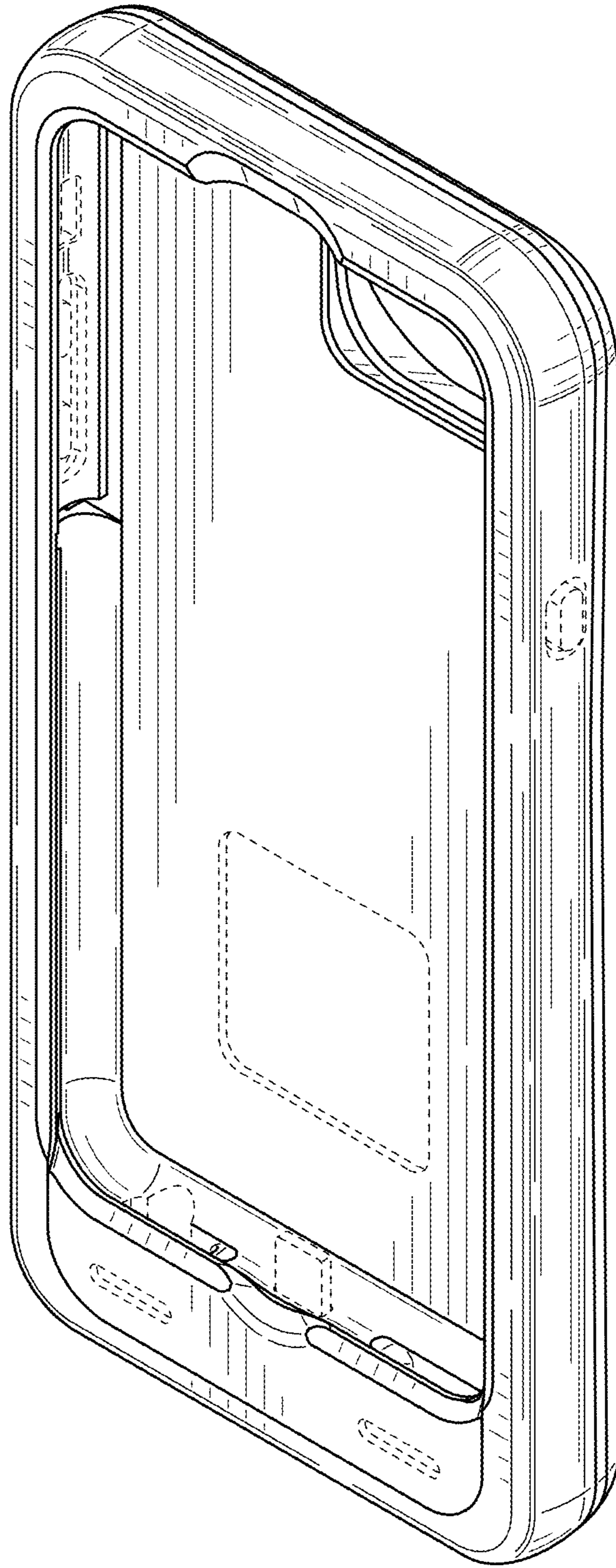

FIG. 1

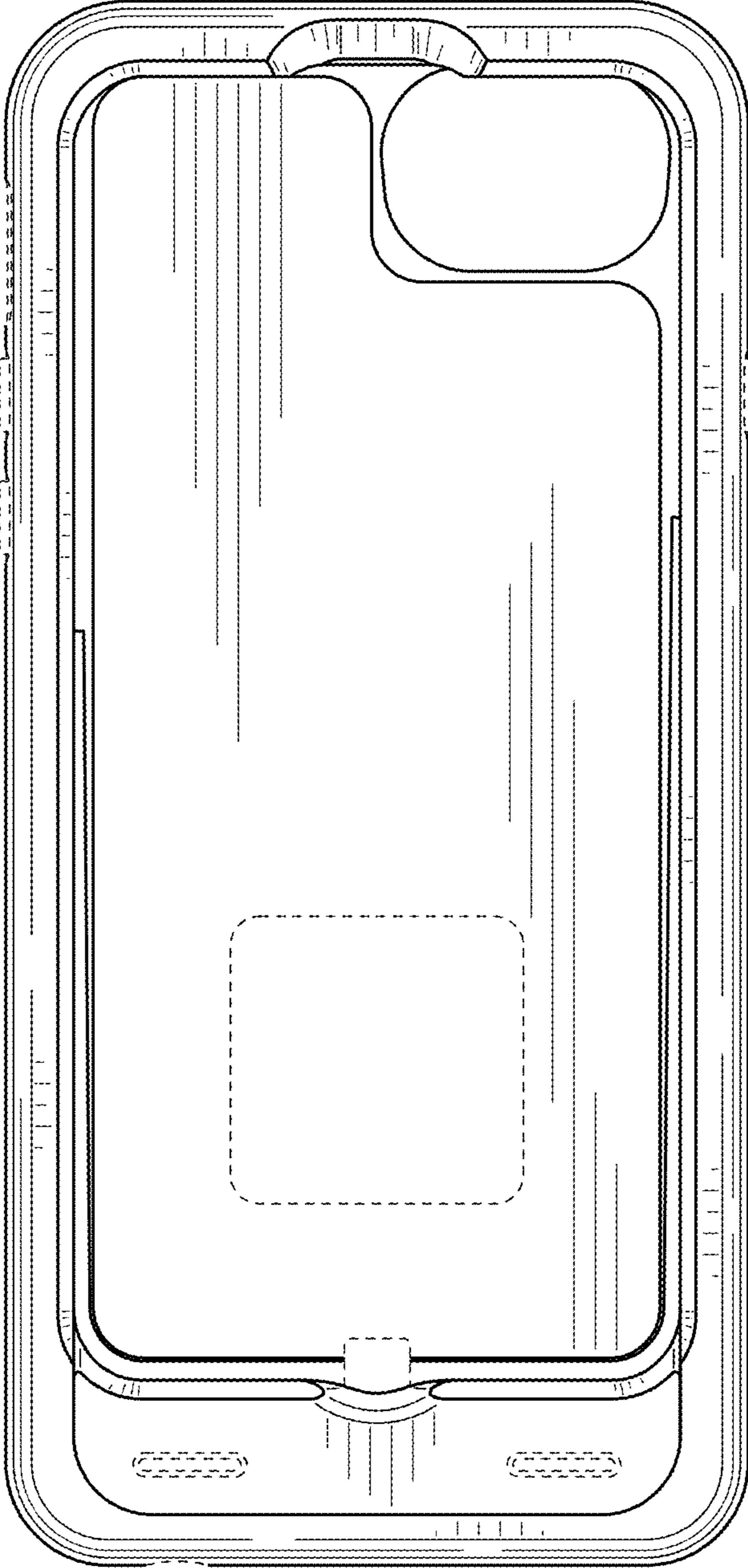

FIG. 2

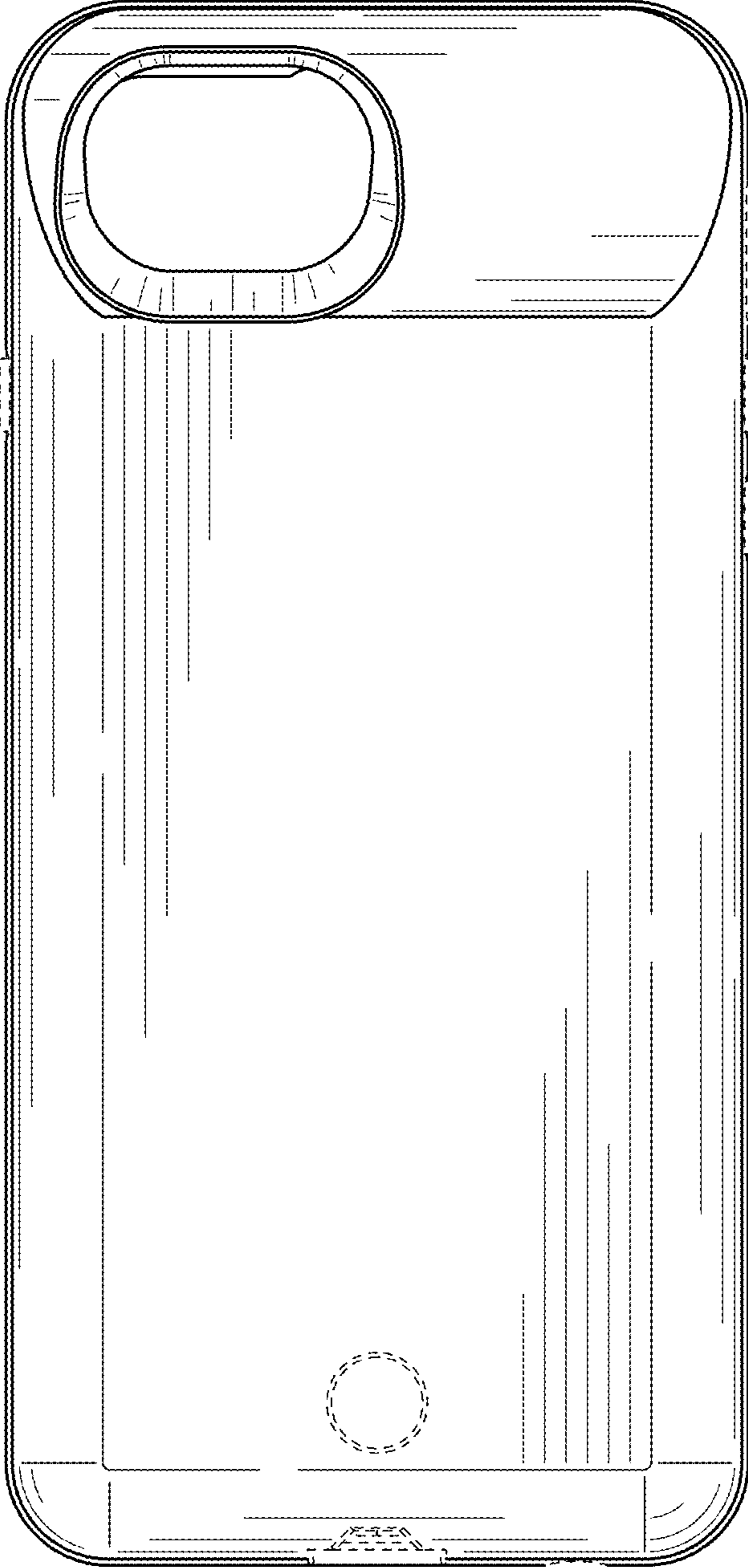

FIG. 3

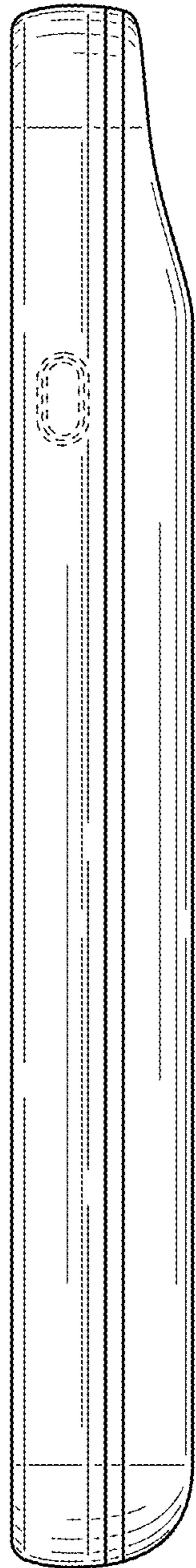

FIG. 4

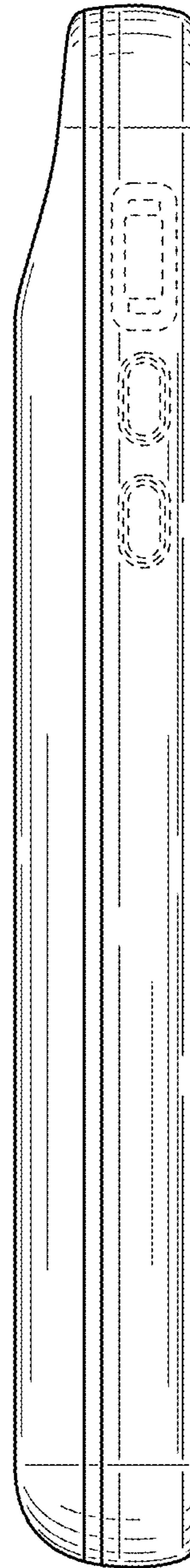

FIG. 5

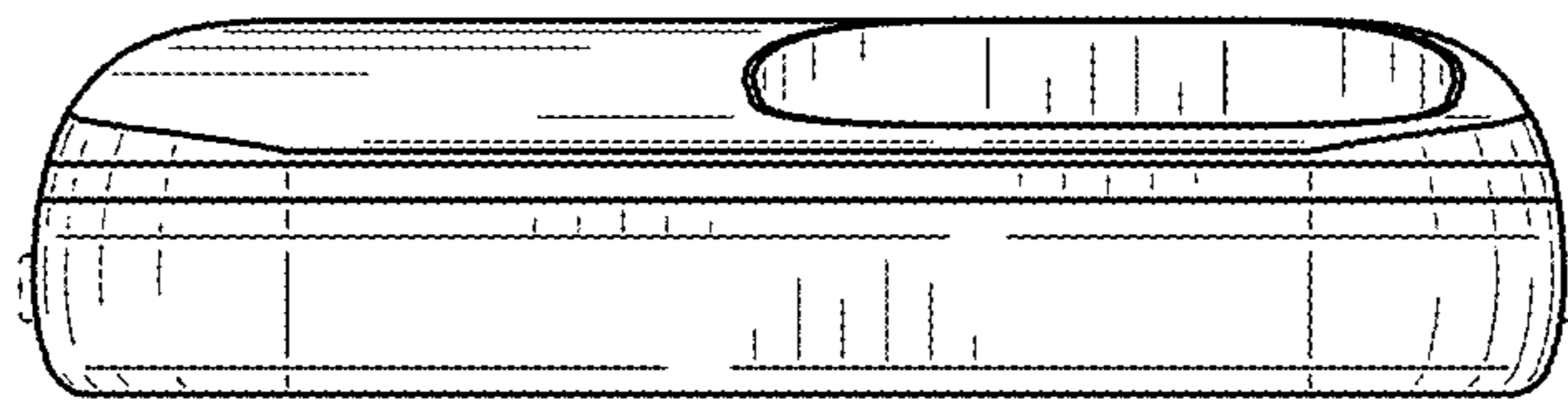

FIG. 6

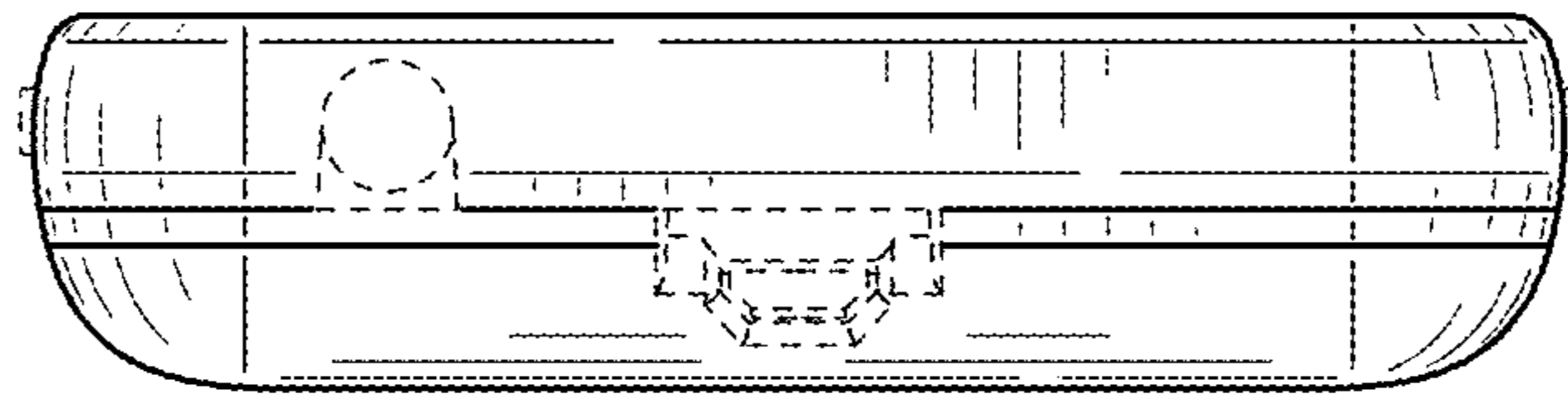

FIG. 7

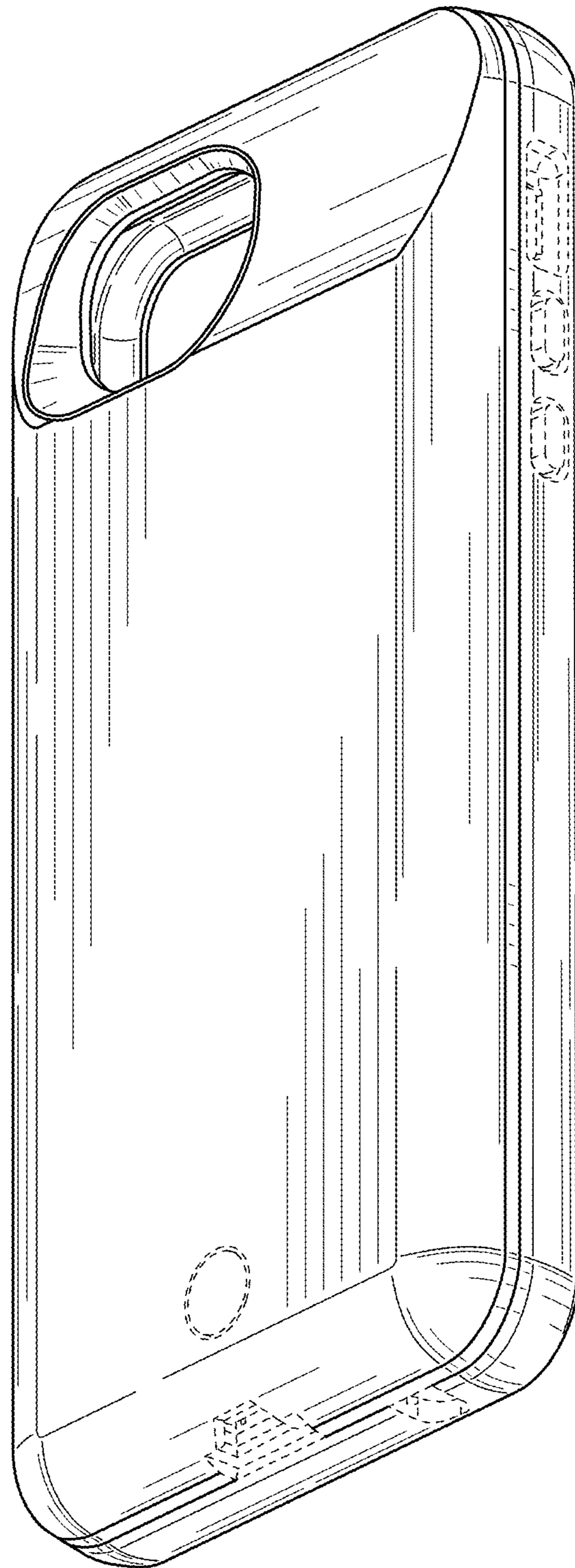

FIG. 8