



US00D908671S

(12) **United States Design Patent** (10) **Patent No.:** **US D908,671 S**
Zhang et al. (45) **Date of Patent:** **** *Jan. 26, 2021**

(54) **ELECTRONIC DEVICE**

(71) Applicant: **Samsung Electronics Co., Ltd.**,
Suwon-si (KR)

(72) Inventors: **Xiangrong Zhang**, Beijing (CN); **Yong Hee Cho**, Seoul (KR); **Ye Liu**, Beijing (CN)

(73) Assignee: **Samsung Electronics Co., Ltd.**,
Suwon-si (KR)

(*) Notice: This patent is subject to a terminal disclaimer.

(**) Term: **15 Years**

(21) Appl. No.: **29/685,255**

(22) Filed: **Mar. 27, 2019**

(30) **Foreign Application Priority Data**

Nov. 16, 2018 (KR) 30-2018-0053244

(51) **LOC (13) Cl.** **14-03**

(52) **U.S. Cl.**
USPC **D14/248**

(58) **Field of Classification Search**
USPC D14/138 G, 138 AD, 248, 341, 371, 374,
D14/138 R, 138 AA, 138 AB, 138 AC,
D14/138 C, 247

(Continued)

(56) **References Cited**

U.S. PATENT DOCUMENTS

D548,218 S * 8/2007 Hong D14/138 AA
D579,902 S * 11/2008 Kim D14/138 AD

(Continued)

OTHER PUBLICATIONS

Samsung Galaxy S10 5G, Feb. 2019, [online], [retrieved on May 22, 2019]. Retrieved from Internet, <URL: <http://www.gsmarena.com>>.*

(Continued)

Primary Examiner — Bridget L Eland

(74) *Attorney, Agent, or Firm* — NSIP Law

(57) **CLAIM**

We claim the ornamental design for an electronic device, as shown and described.

DESCRIPTION

FIG. 1 is a front perspective view of a first embodiment of an electronic device showing our new design;

FIG. 2 is a front view thereof;

FIG. 3 is a rear view thereof;

FIG. 4 is a left-side view thereof;

FIG. 5 is a right-side view thereof;

FIG. 6 is a top view thereof;

FIG. 7 is a bottom view thereof;

FIG. 8 is a rear perspective view thereof;

FIG. 9 is a front perspective view of a second embodiment of an electronic device showing our new design;

FIG. 10 is a front view thereof;

FIG. 11 is a rear view thereof;

FIG. 12 is a left-side view thereof;

FIG. 13 is a right-side view thereof;

FIG. 14 is a top view thereof;

FIG. 15 is a bottom view thereof;

FIG. 16 is a rear perspective view thereof;

FIG. 17 is a front perspective view of a third embodiment of an electronic device showing our new design;

FIG. 18 is a front view thereof;

FIG. 19 is a rear view thereof;

FIG. 20 is a left-side view thereof;

FIG. 21 is a right-side view thereof;

FIG. 22 is a top view thereof;

FIG. 23 is a bottom view thereof;

FIG. 24 is a rear perspective view thereof;

FIG. 25 is a front perspective view of a fourth embodiment of an electronic device showing our new design;

FIG. 26 is a front view thereof;

FIG. 27 is a rear view thereof;

FIG. 28 is a left-side view thereof;

FIG. 29 is a right-side view thereof;

FIG. 30 is a top view thereof;

FIG. 31 is a bottom view thereof; and,

(Continued)

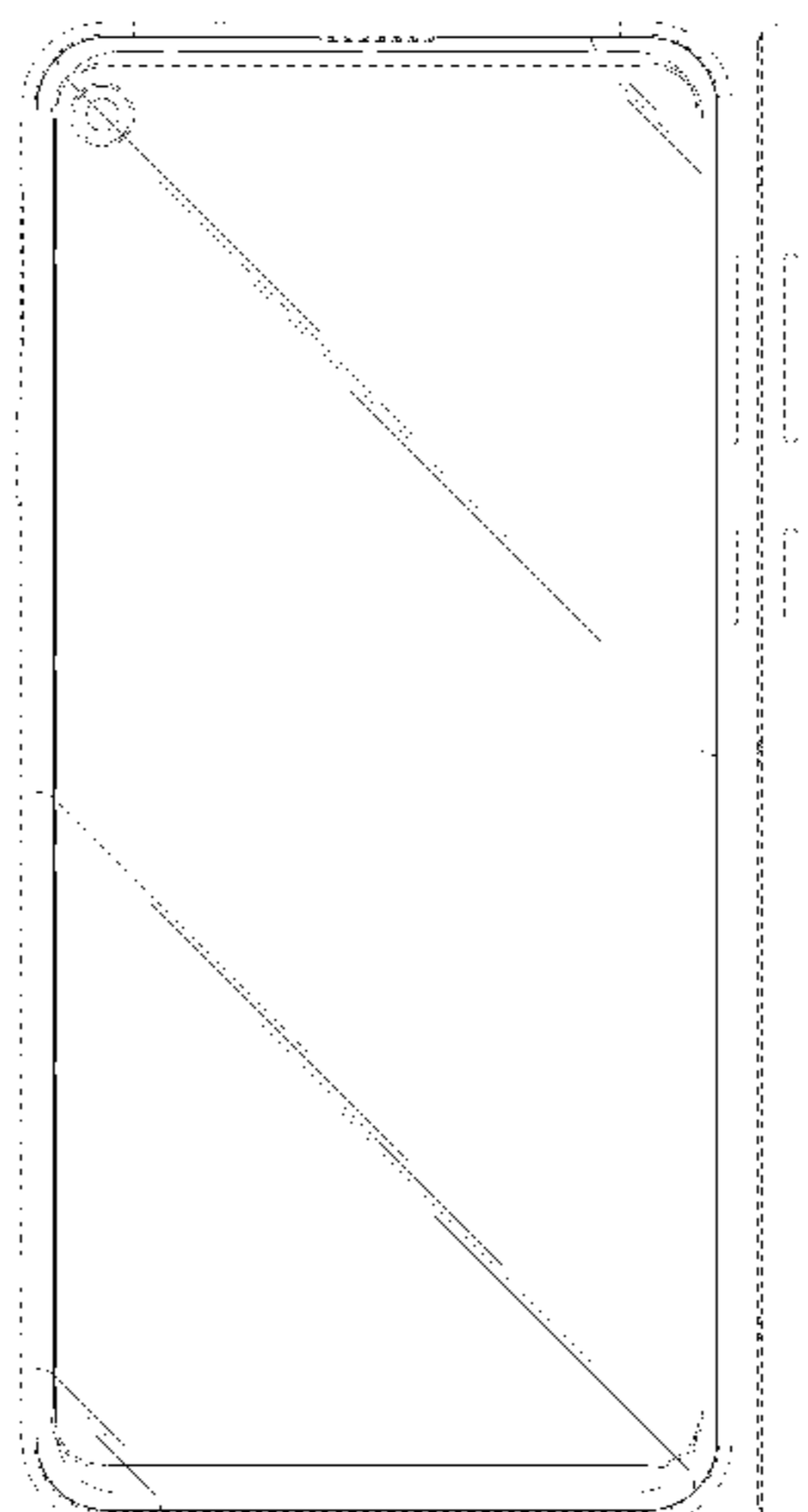

FIG. 32 is a rear perspective view thereof.
The broken lines in the figures depict portions of the electronic device which form no part of the claimed design.

1 Claim, 24 Drawing Sheets

(58) **Field of Classification Search**

CPC H04M 1/0202; H04M 1/0235; H04M
1/0237; H04M 1/0239; H04M 1/0266;
H04M 1/0268; H04M 1/027; H04M
1/0295; H04M 1/02; H04M 1/0279;
H04M 1/0283

See application file for complete search history.

(56)

References Cited

U.S. PATENT DOCUMENTS

D592,168 S * 5/2009 Bai D14/138 AD
D656,118 S * 3/2012 Kim D14/138 G
D815,632 S * 4/2018 Akana D14/341
D820,833 S * 6/2018 Kim D14/341
D829,205 S * 9/2018 Akana D14/341
D847,776 S * 5/2019 Ryu D14/138 G
D849,706 S * 5/2019 Park D14/138 G
D854,508 S * 7/2019 Park D14/138 C
D857,643 S * 8/2019 Choi D14/138 G
D861,675 S * 10/2019 Kim D14/341
D863,293 S * 10/2019 Kim D14/341
D864,142 S * 10/2019 Fan D14/138 AD
D865,732 S * 11/2019 Park D14/248
D865,734 S * 11/2019 Park D14/248
D865,735 S * 11/2019 Park D14/248
D865,737 S * 11/2019 Park D14/248
D865,738 S * 11/2019 Park D14/248

D866,496 S * 11/2019 Kim D14/138 G
D867,351 S * 11/2019 Park D14/248
D869,422 S * 12/2019 Cho D14/138 G
D888,029 S * 6/2020 Kim D14/248
D888,030 S * 6/2020 Kim D14/248
D890,736 S * 7/2020 Park D14/248
D890,737 S * 7/2020 Park D14/248
D892,780 S * 8/2020 Park D14/248
D892,781 S * 8/2020 Park D14/248
D894,163 S * 8/2020 Kim D14/248
D894,885 S * 9/2020 Park
2011/0186345 A1* 8/2011 Pakula G06F 1/1637
174/520
2013/0058039 A1* 3/2013 Lee G06F 1/203
361/690
2018/0244565 A1* 8/2018 Paulson C03C 17/23
2019/0302841 A1* 10/2019 Sun G06F 1/1626

OTHER PUBLICATIONS

Samsung Galaxy S10+, Feb. 2019, [online], [retrieved on May 22, 2019]. Retrieved from Internet, <URL: <http://www.gsmarena.com>>.*
Samsung Galaxy S10e, Feb. 2019, [online], [retrieved on May 22, 2019]. Retrieved from Internet, <URL: <http://www.gsmarena.com>>.*
Nokia X71, Apr. 2019, [online], [retrieved on May 22, 2019]. Retrieved from Internet, <URL: <http://www.gsmarena.com>>.*
Motorola One Vision, May 2019, [online], [retrieved on May 22, 2019]. Retrieved from Internet, <URL: <http://www.gsmarena.com>>.*
Honor 20, May 2019, [online], [retrieved on May 22, 2019]. Retrieved from Internet, <URL: <http://www.gsmarena.com>>.*
Samsung Galaxy A21, Apr. 8, 2020, [online], [retrieved on Jun. 15, 2020]. Retrieved from Internet, <URL: <http://www.gsmarena.com>>.*

* cited by examiner

FIG.1

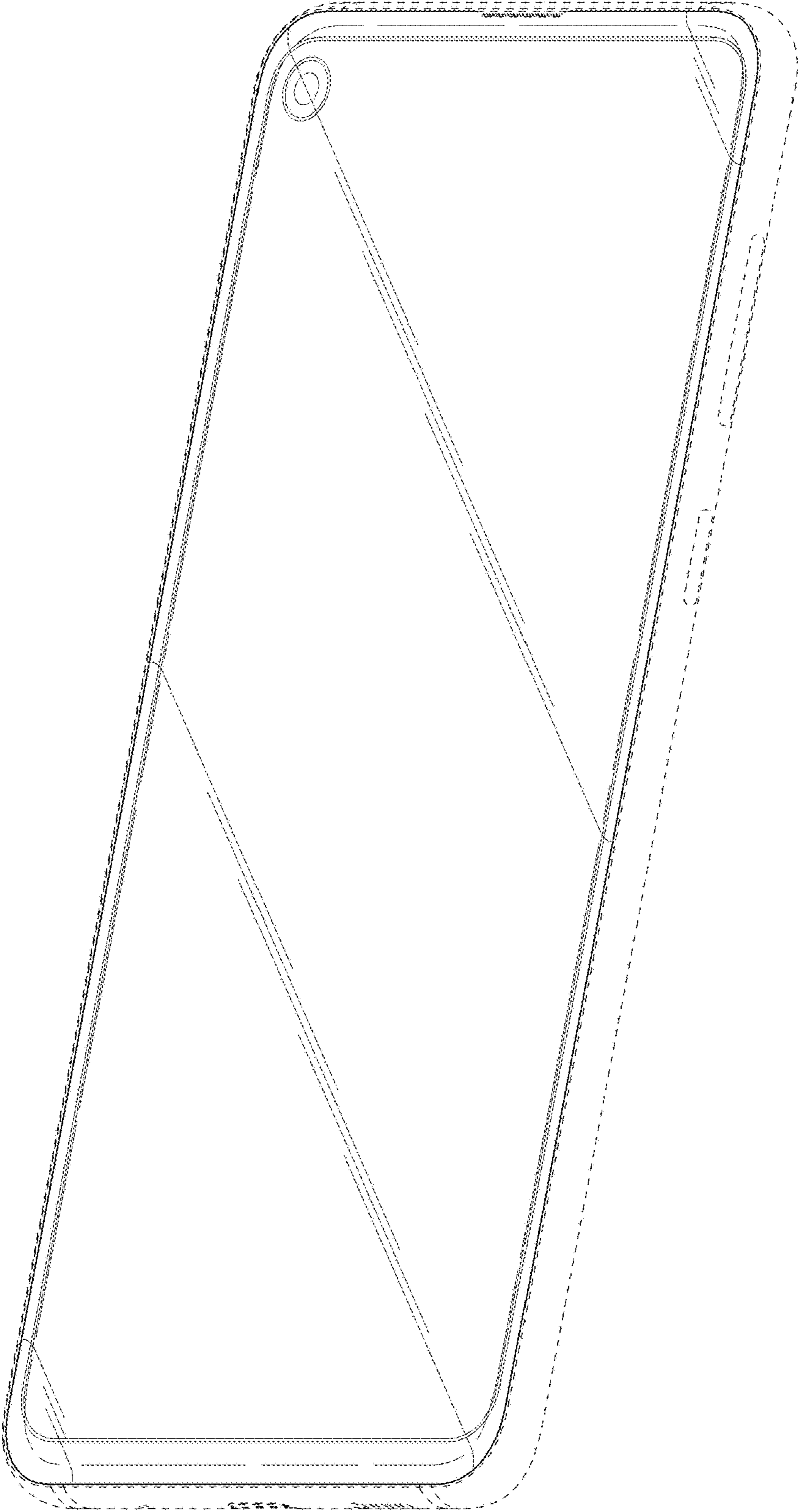

FIG.2

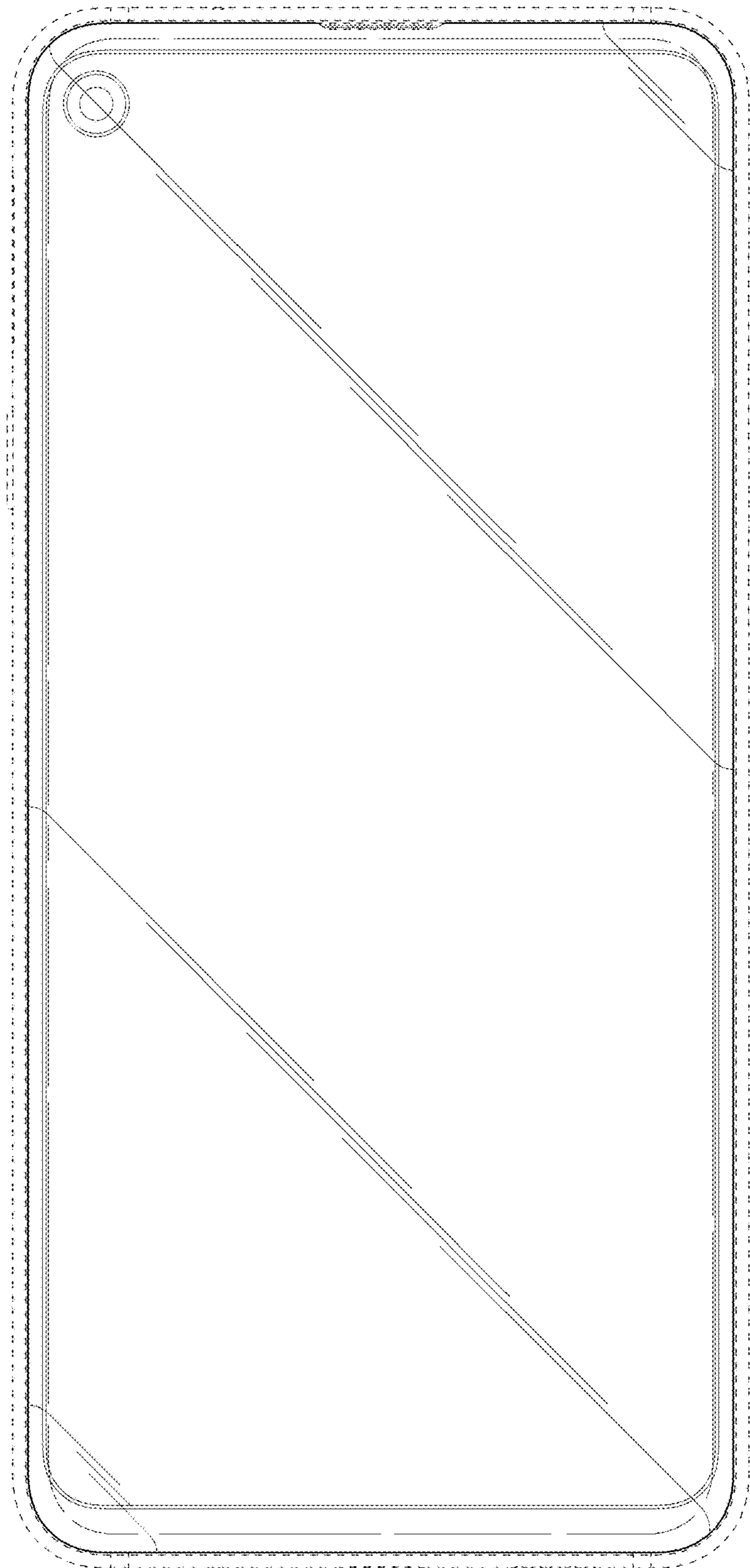

FIG.3

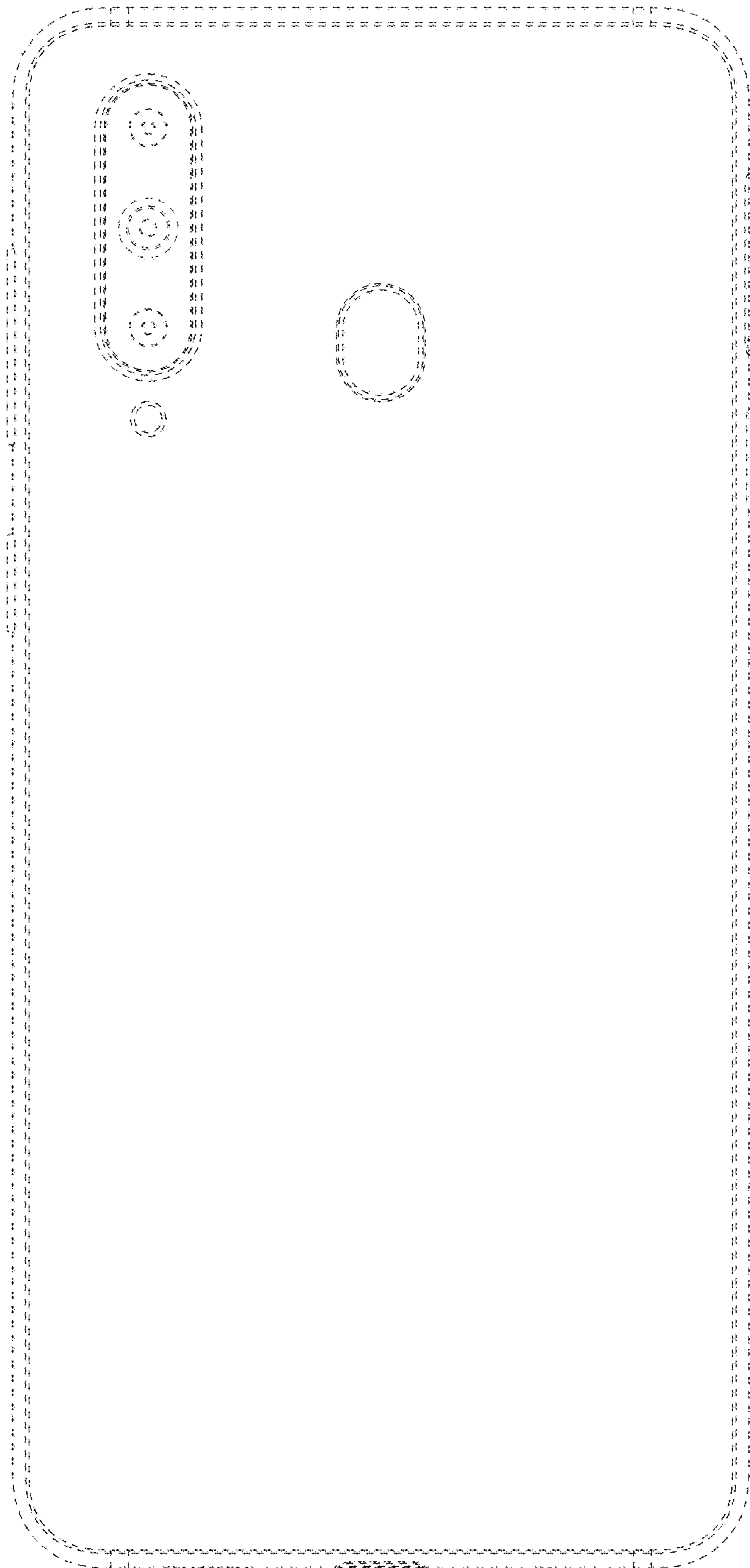

FIG.4

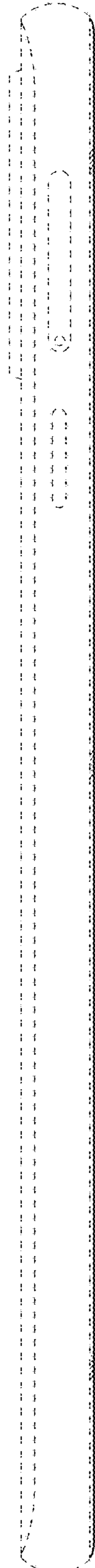

FIG.5

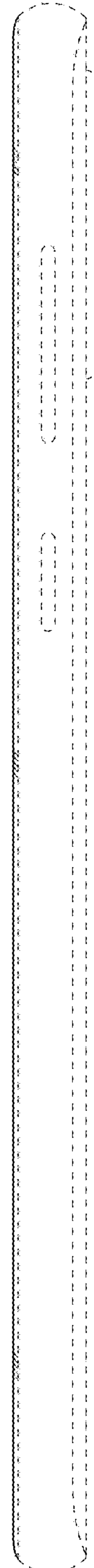

FIG.6

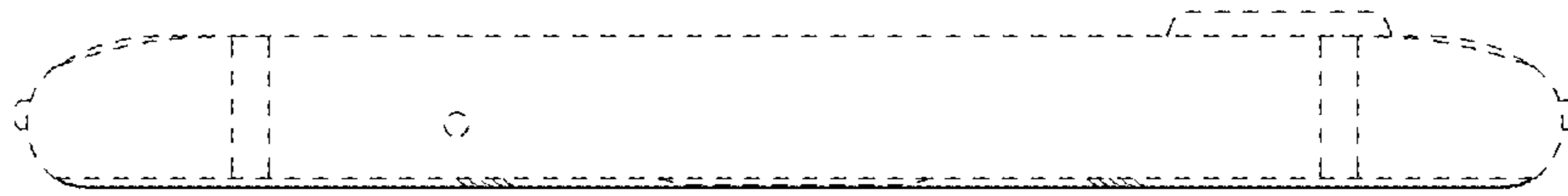

FIG.7

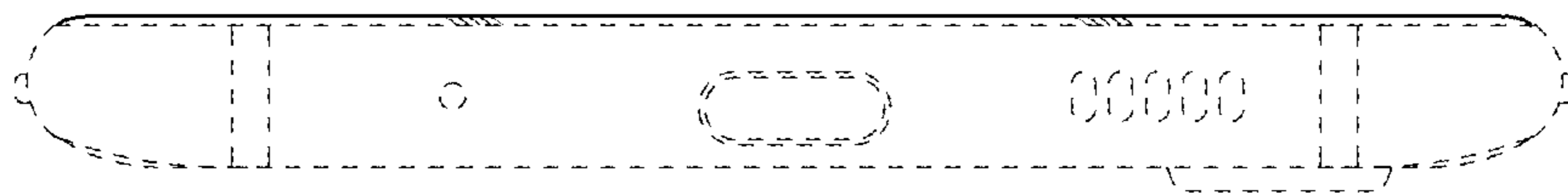

FIG.8

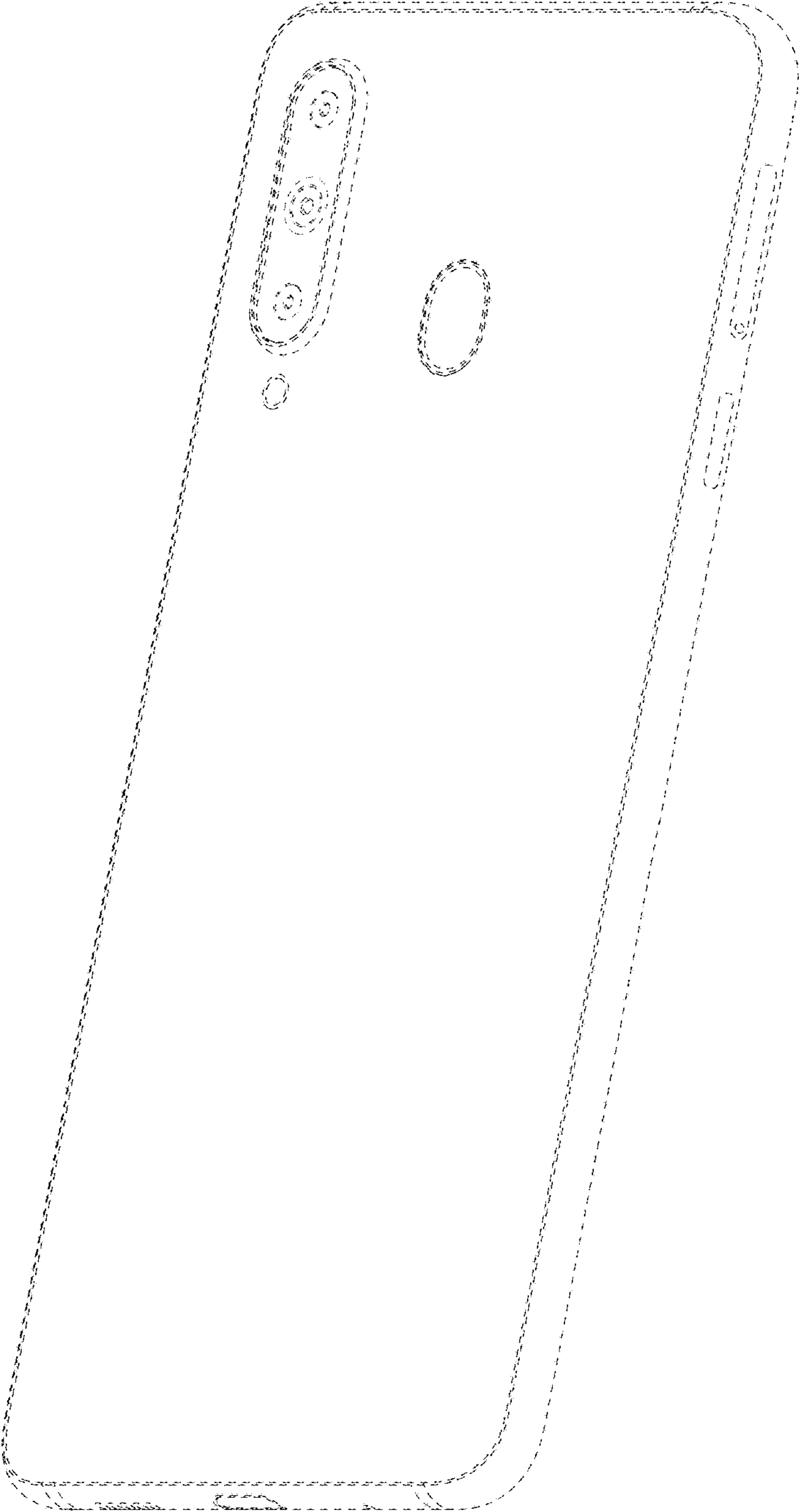

FIG.9

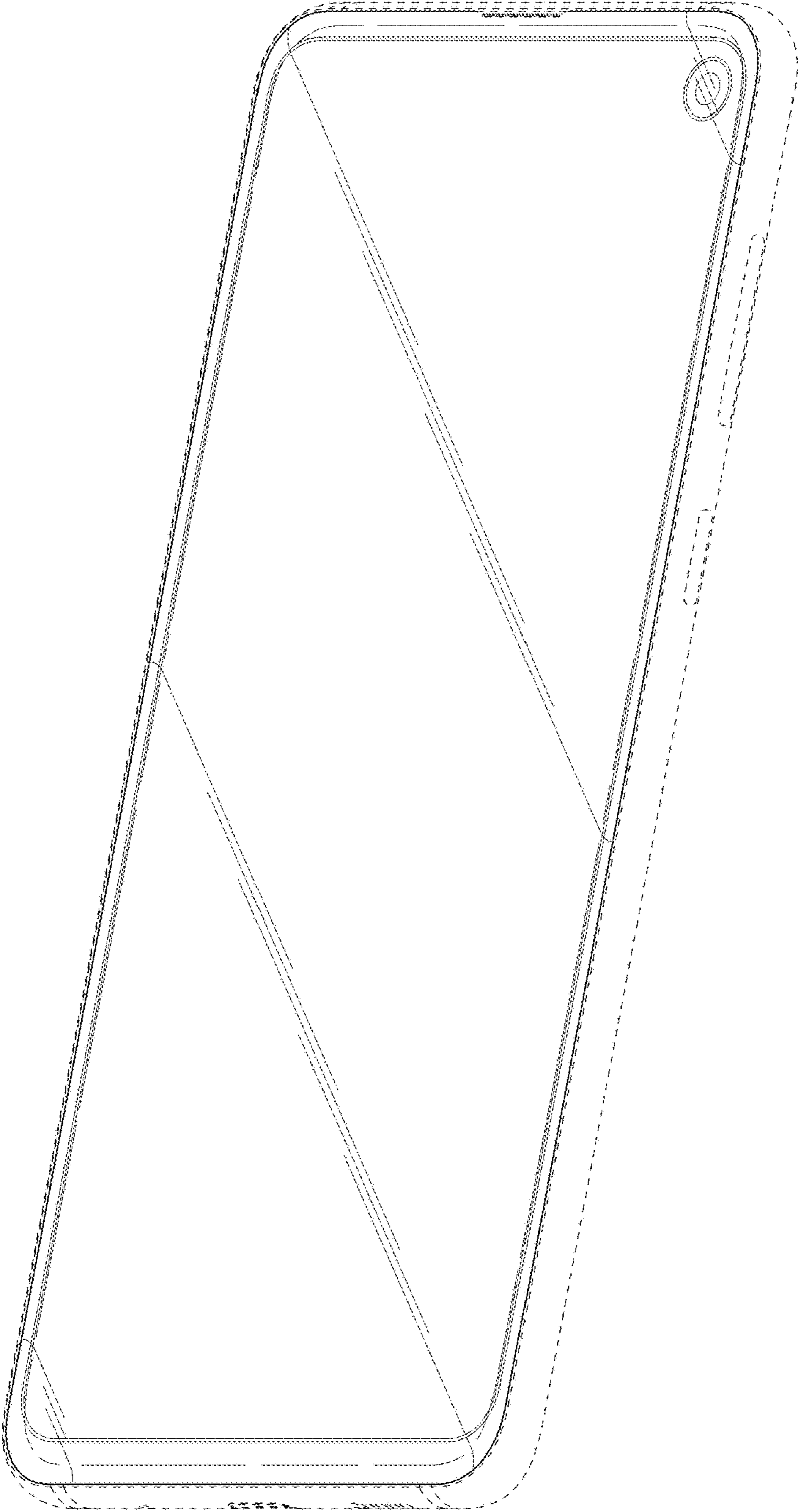

FIG. 10

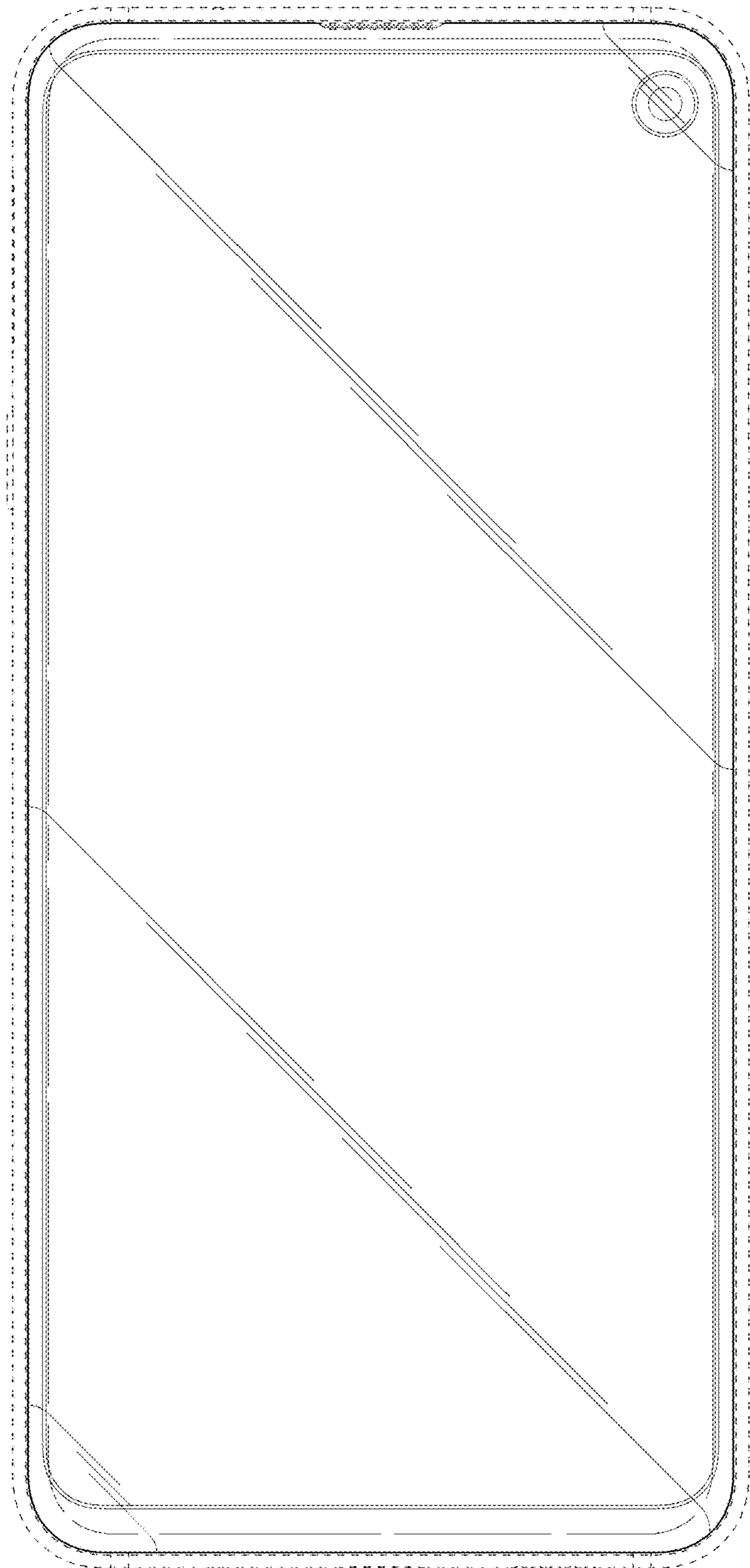

FIG. 11

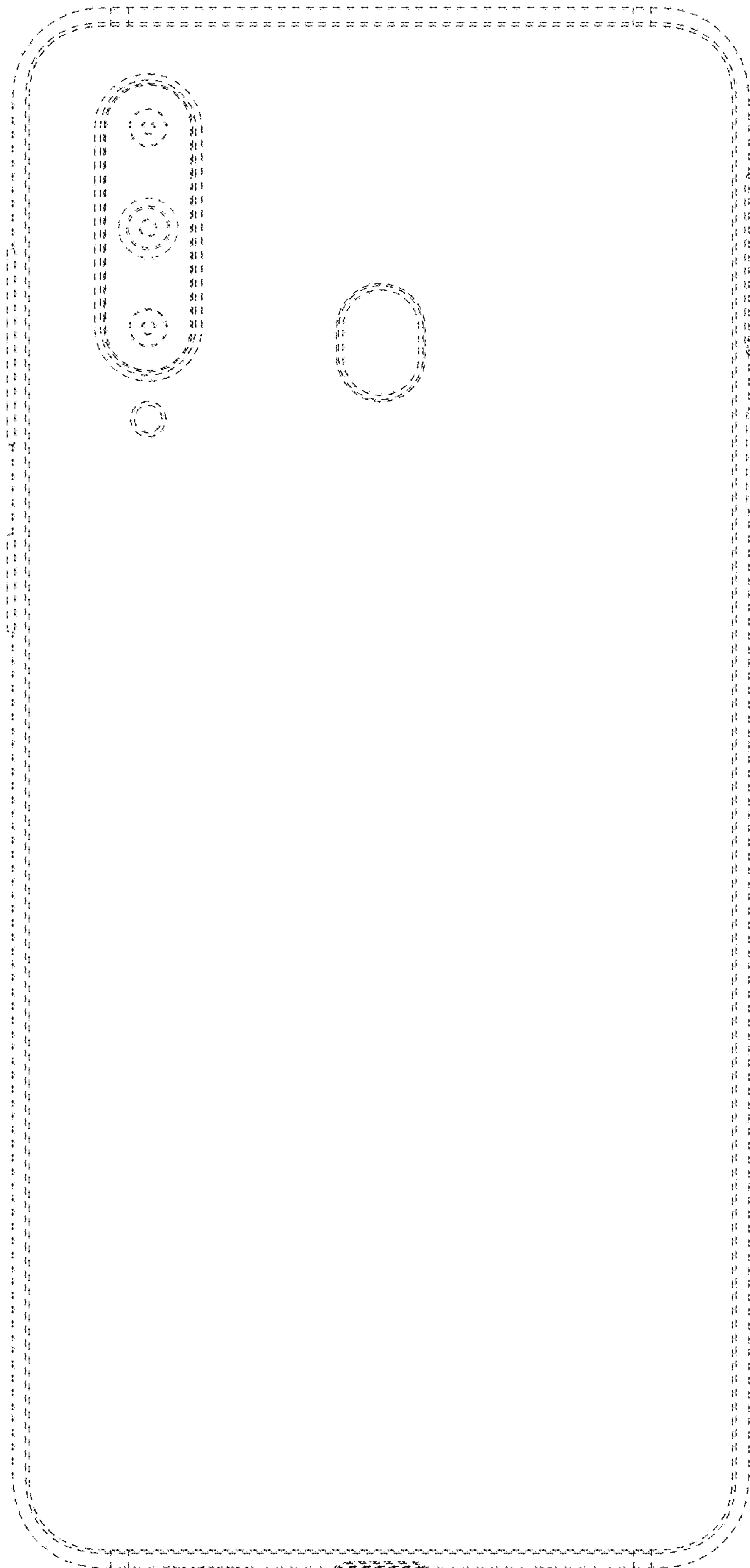

FIG.12

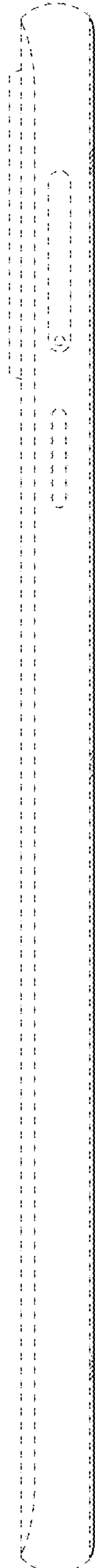

FIG.13

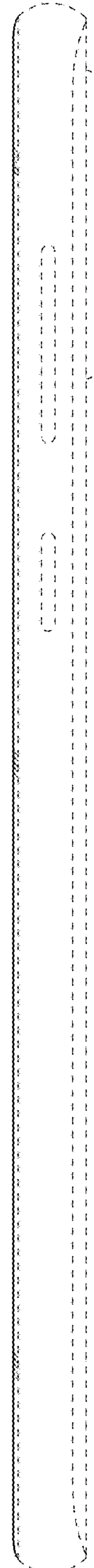

FIG.14

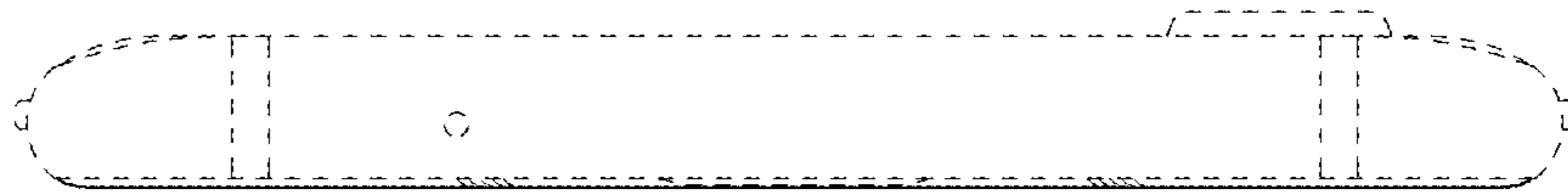

FIG.15

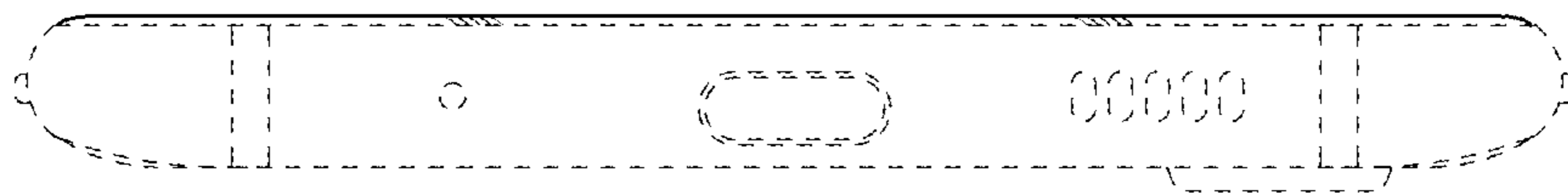

FIG.16

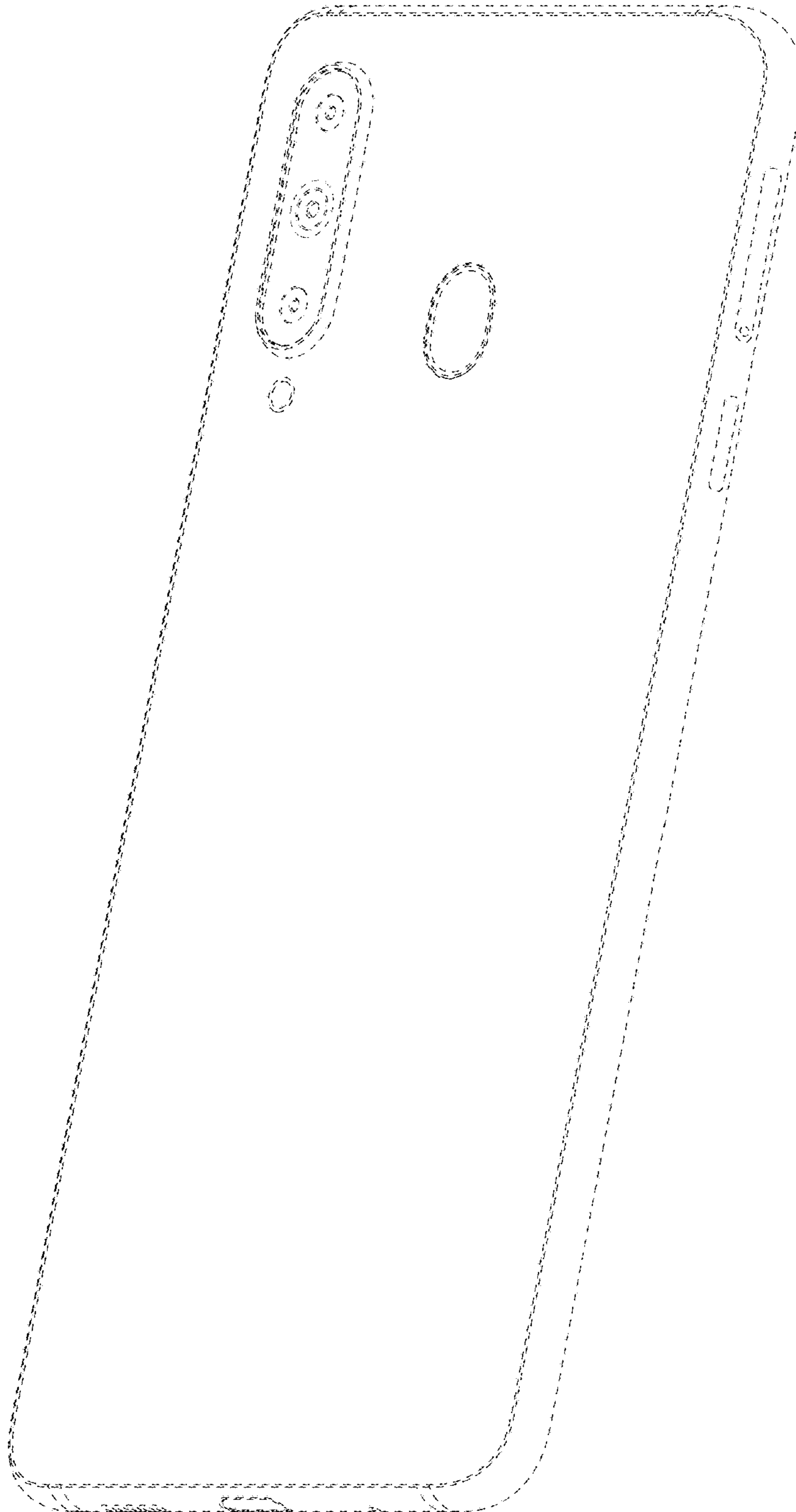

FIG.17

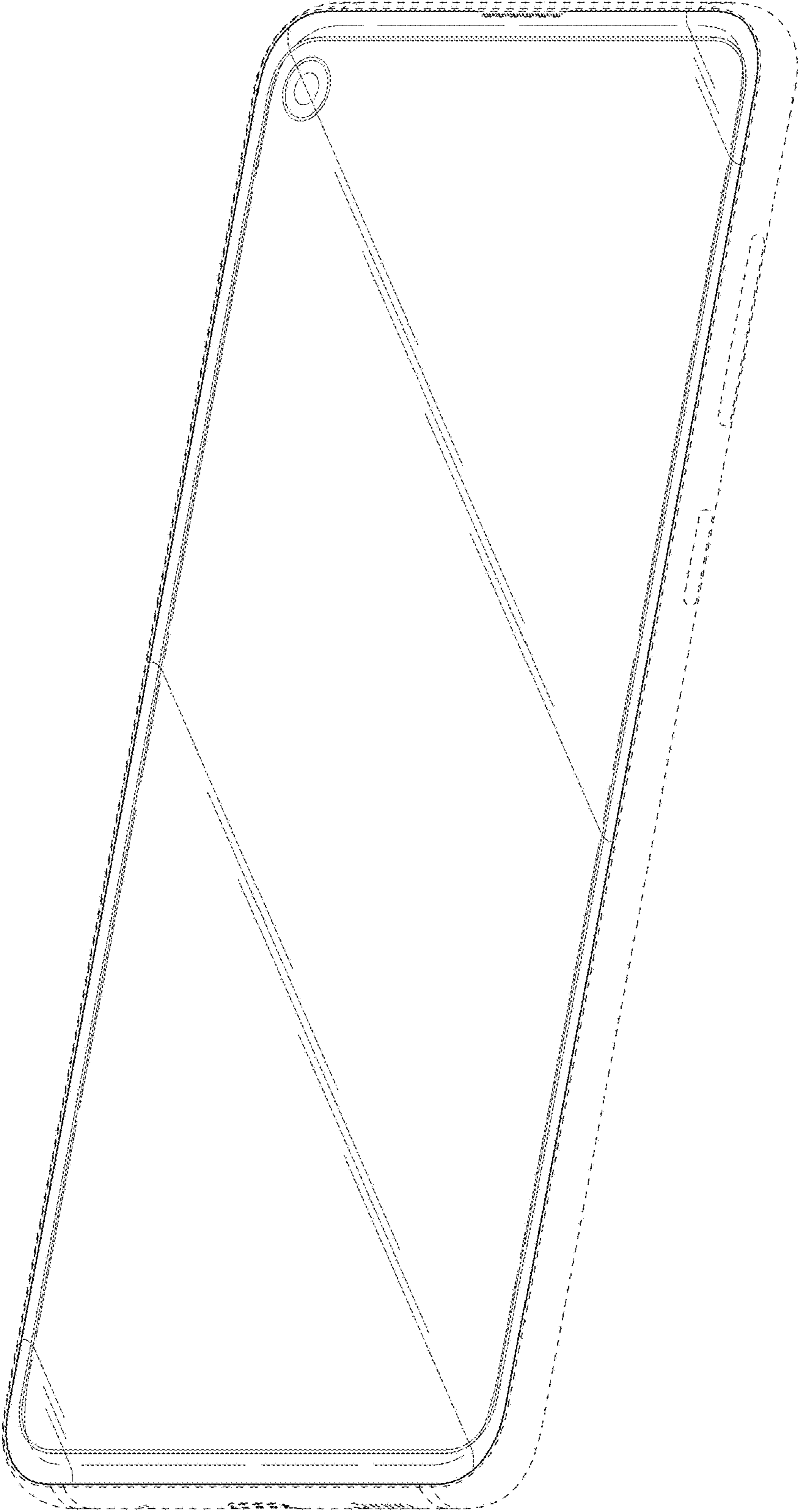

FIG. 18

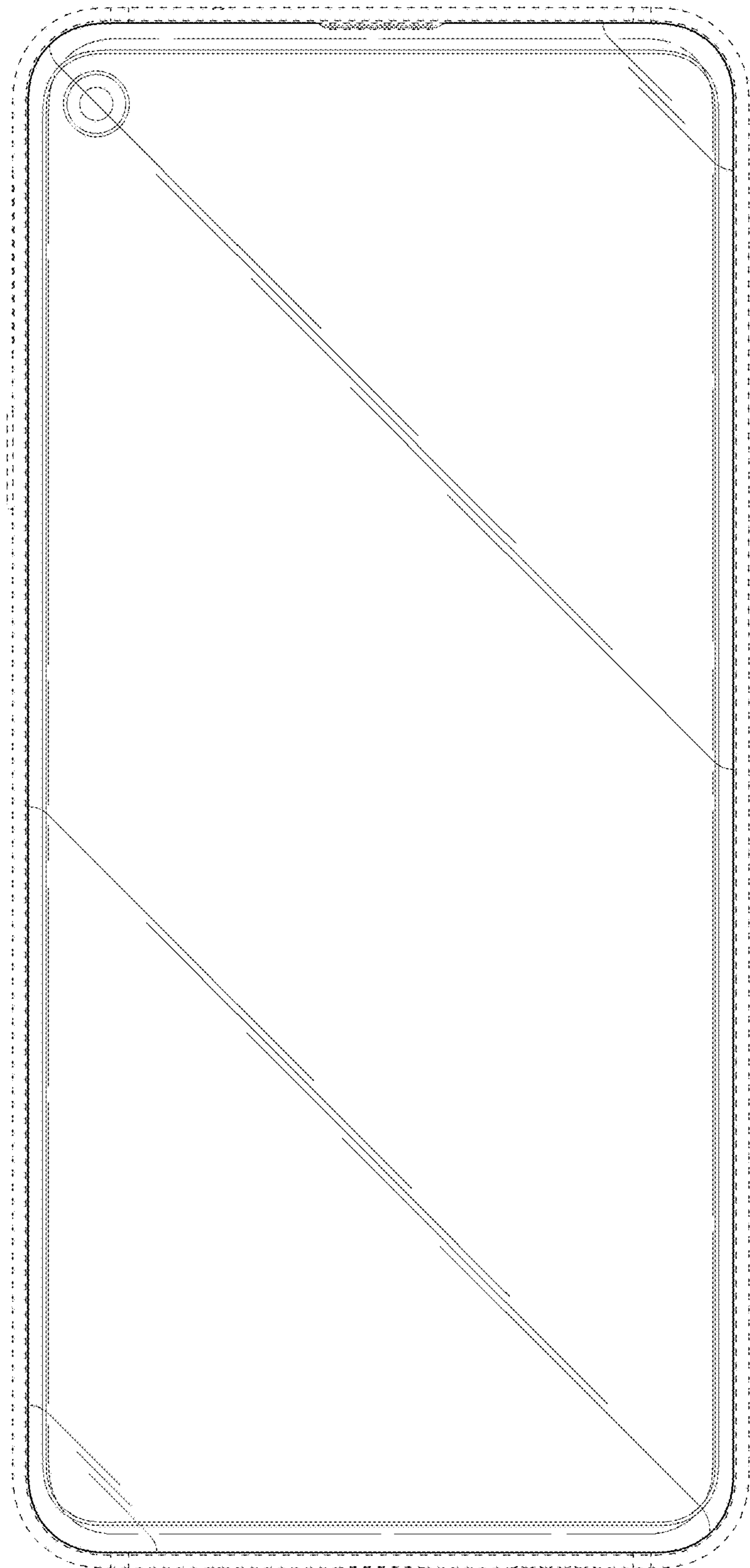

FIG. 19

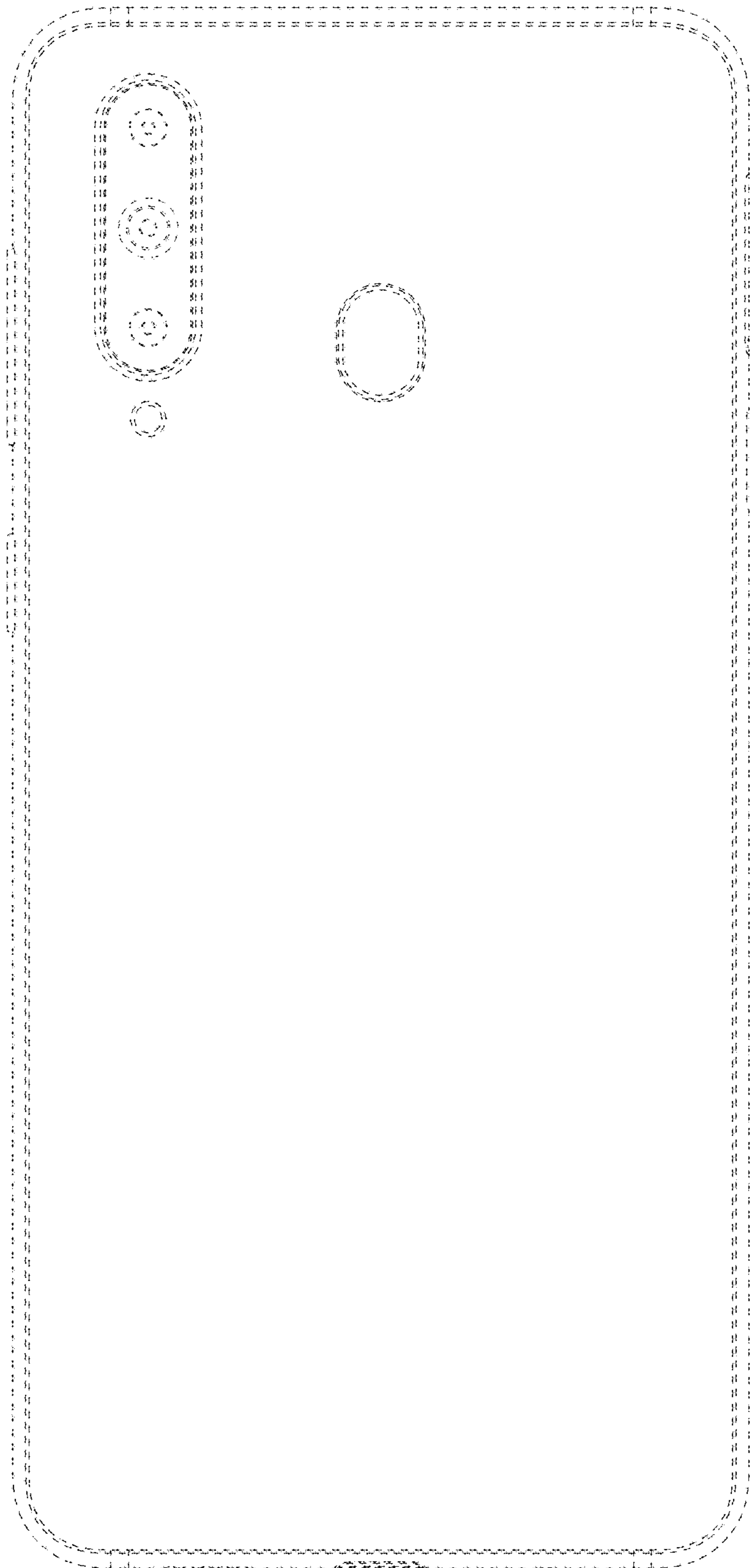

FIG.20

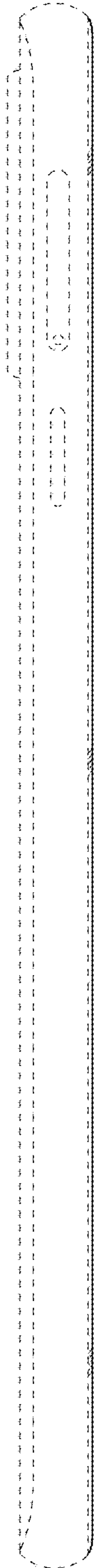

FIG.21

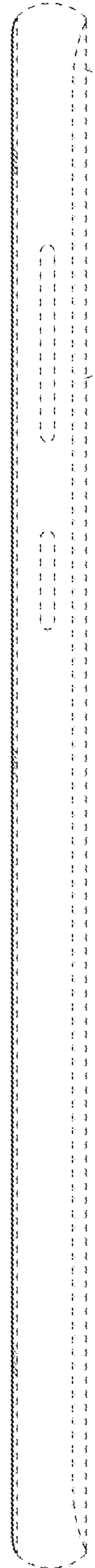

FIG.22

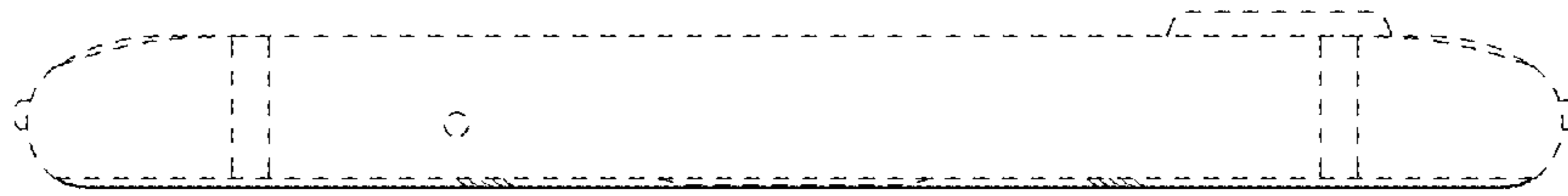

FIG.23

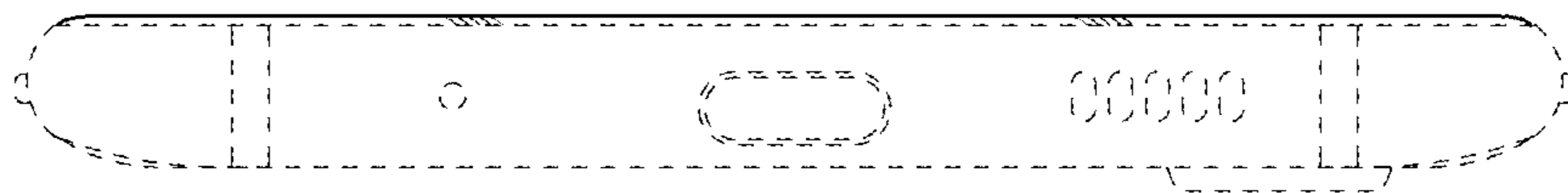

FIG.24

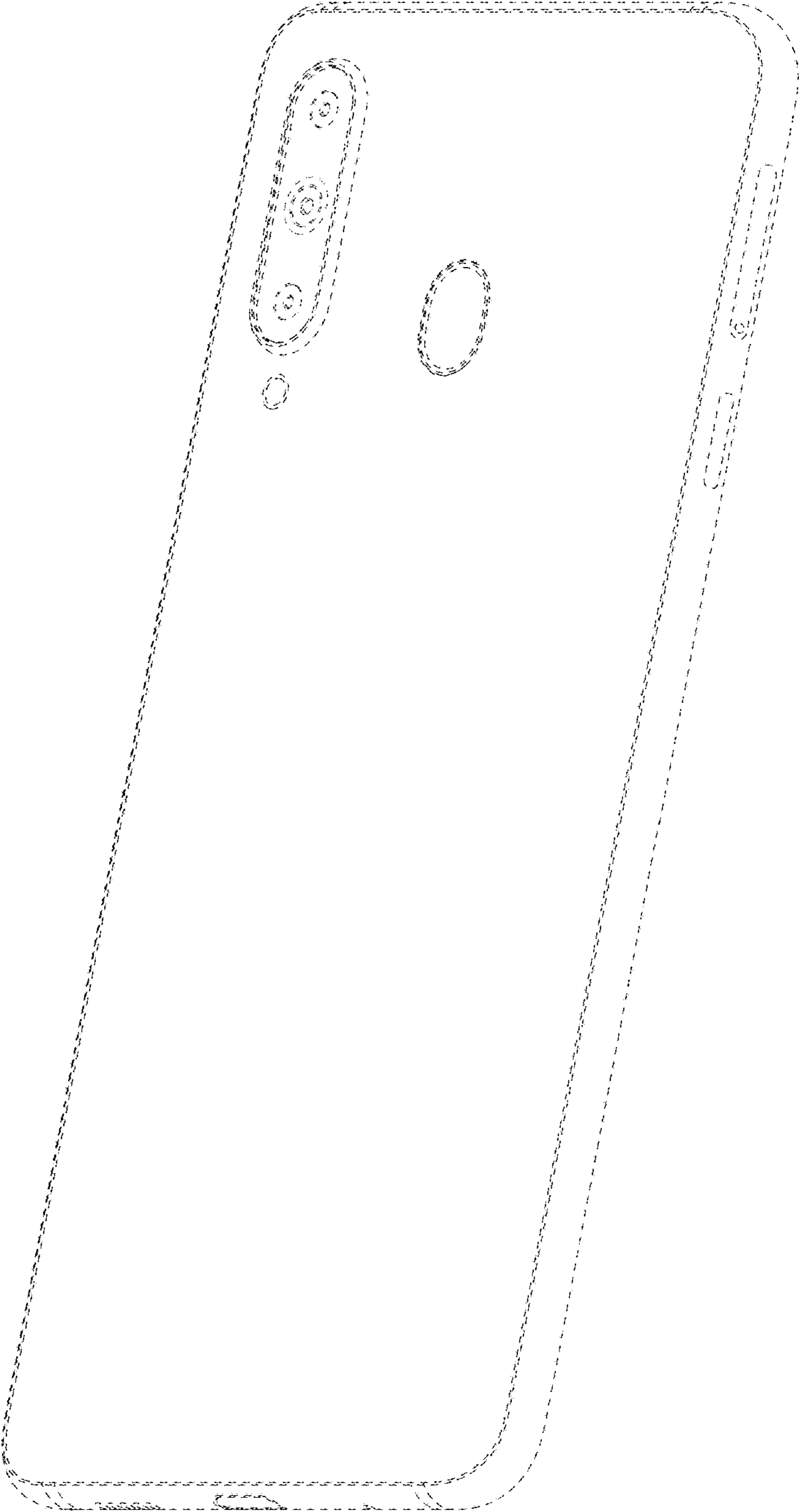

FIG.25

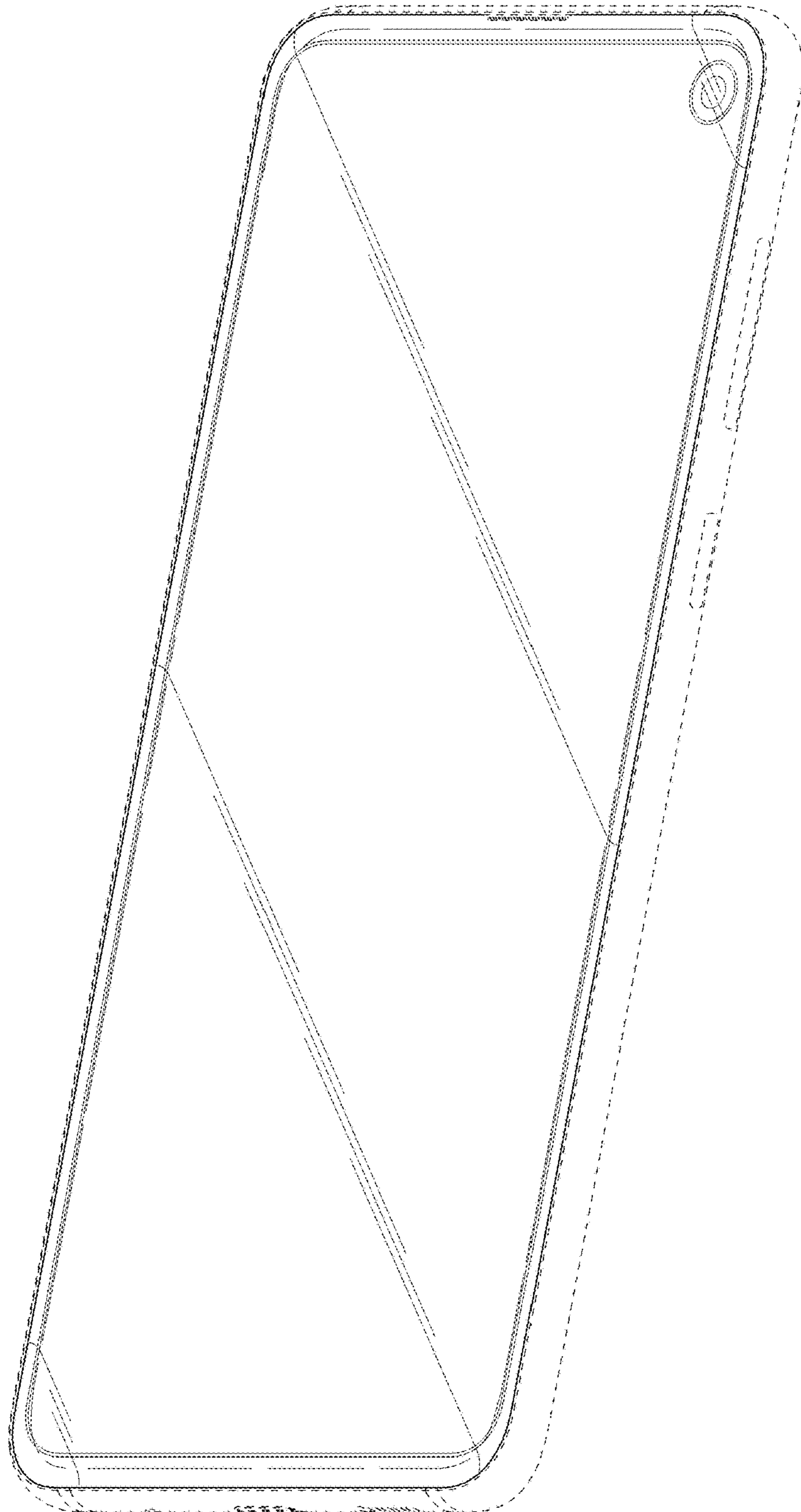

FIG.26

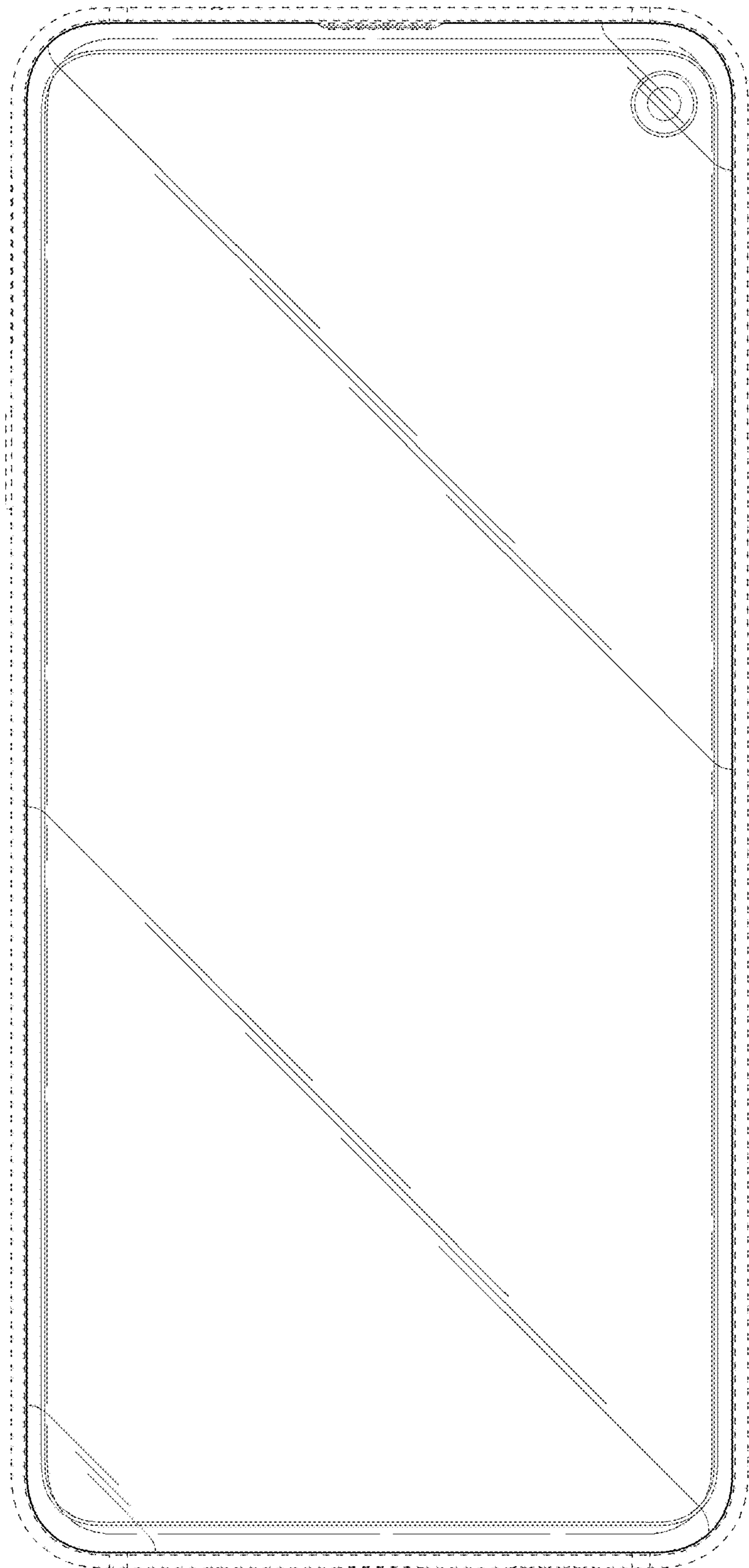

FIG.27

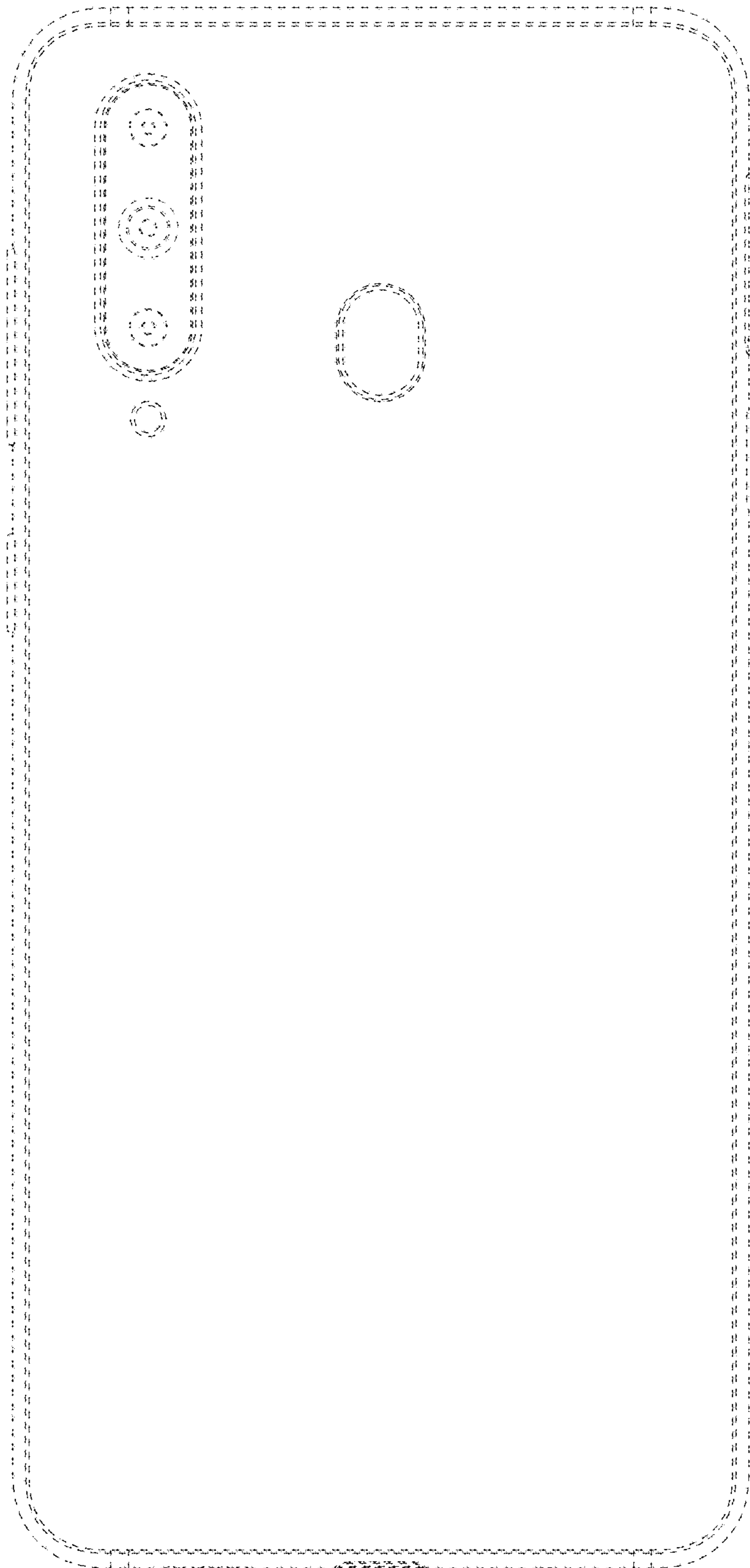

FIG.28

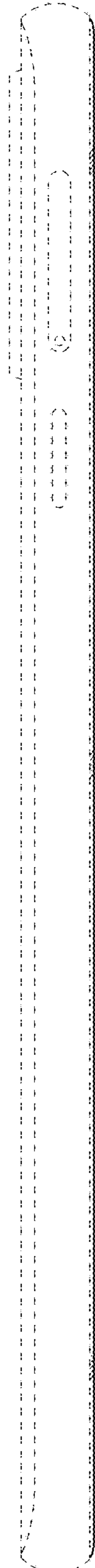

FIG.29

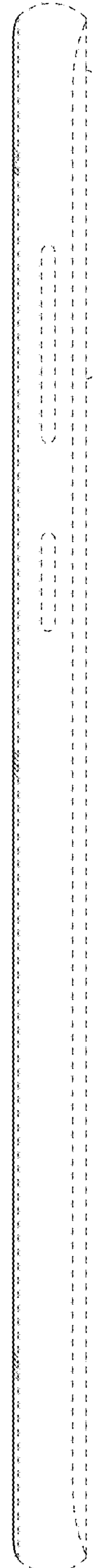

FIG.30

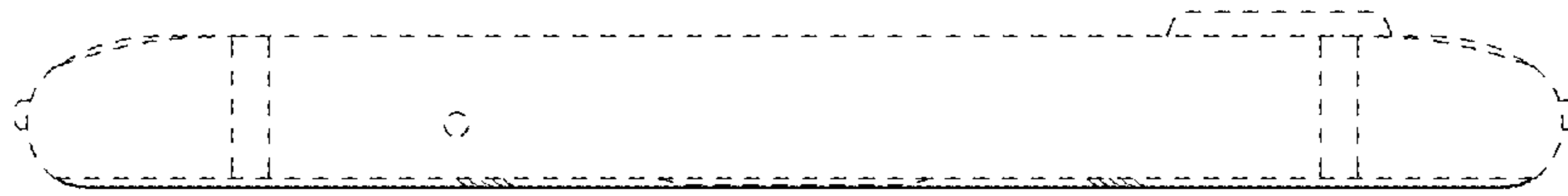

FIG.31

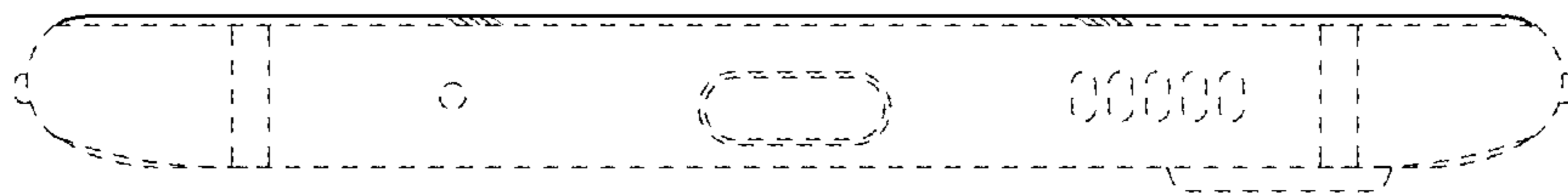

FIG.32

