



US00D908553S

(12) **United States Design Patent** (10) **Patent No.:** **US D908,553 S**  
**Bischoff et al.** (45) **Date of Patent:** **\*\* Jan. 26, 2021**

(54) **RADIATOR GRILLE FOR VEHICLE**

D859,213 S \* 9/2019 Bischoff ..... D12/91  
D875,608 S \* 2/2020 Bischoff ..... D12/92  
D892,679 S \* 8/2020 Bischoff ..... D12/88  
D899,310 S \* 10/2020 Kirzinger ..... D12/91

(71) Applicant: **VOLKSWAGEN AKTIENGESELLSCHAFT,**  
Wolfsburg (DE)

FOREIGN PATENT DOCUMENTS

(72) Inventors: **Klaus Bischoff,** Wolfsburg (DE); **Frank Josef Brüse,** Wolfsburg (DE)

WO DM097097 6/2017

(73) Assignee: **VOLKSWAGEN AKTIENGESELLSCHAFT,**  
Wolfsburg (DE)

OTHER PUBLICATIONS

(\*\*) Term: **15 Years**

VW Atlas, Published date unavailable [online], [retrieved on Dec. 3, 2020]. Retrieved from the Internet: [https://www.vw.com/en/models/atlas.html?---=%7B%22models\\_atlas\\_sectiongroup\\_9747253\\_featureappsection%22%3A%22%2F%3Fzip%3D90210%22%7D](https://www.vw.com/en/models/atlas.html?---=%7B%22models_atlas_sectiongroup_9747253_featureappsection%22%3A%22%2F%3Fzip%3D90210%22%7D) (Year: 2020).\*

(21) Appl. No.: **29/718,455**

\* cited by examiner

(22) Filed: **Dec. 24, 2019**

(30) **Foreign Application Priority Data**

*Primary Examiner* — Michael A. Pratt

Jun. 27, 2019 (WO) ..... 84792

*Assistant Examiner* — Adam C Mager

(51) **LOC (13) Cl.** ..... **12-16**

(74) *Attorney, Agent, or Firm* — Lucas & Mercanti, LLP; Klaus P. Stoffel

(52) **U.S. Cl.**  
USPC ..... **D12/163**

(57) **CLAIM**

(58) **Field of Classification Search**  
USPC ..... D12/96, 163, 167, 169, 171, 172, 181,  
D12/190, 196; D21/561  
CPC ... B60R 19/00; B60R 19/52; B60R 2019/525;  
B60R 2019/527  
See application file for complete search history.

The ornamental design for a radiator grille for vehicle, as shown and described.

**DESCRIPTION**

(56) **References Cited**

U.S. PATENT DOCUMENTS

D818,881 S \* 5/2018 Bischoff ..... D12/91  
D826,094 S \* 8/2018 Bischoff ..... D12/92  
D851,548 S \* 6/2019 Mack ..... D12/163  
D851,549 S \* 6/2019 Mack ..... D12/163

FIG. 1 is a front and right side perspective view of the radiator grille for vehicle of the present invention; FIG. 2 is a rear and right side perspective view thereof; FIG. 3 is a front view thereof; FIG. 4 is a rear view thereof; FIG. 5 is a top view thereof; FIG. 6 is a bottom view thereof; FIG. 7 is a left side view thereof; and, FIG. 8 is a right side view thereof.

**1 Claim, 4 Drawing Sheets**

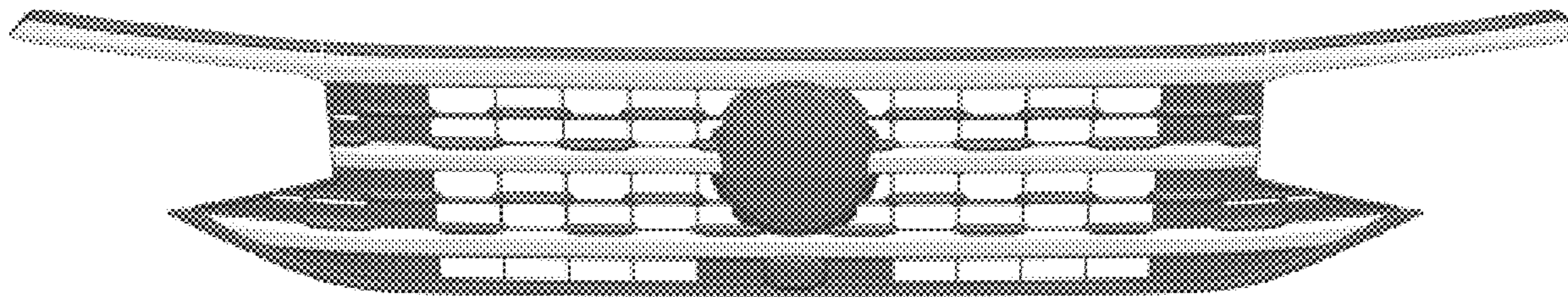

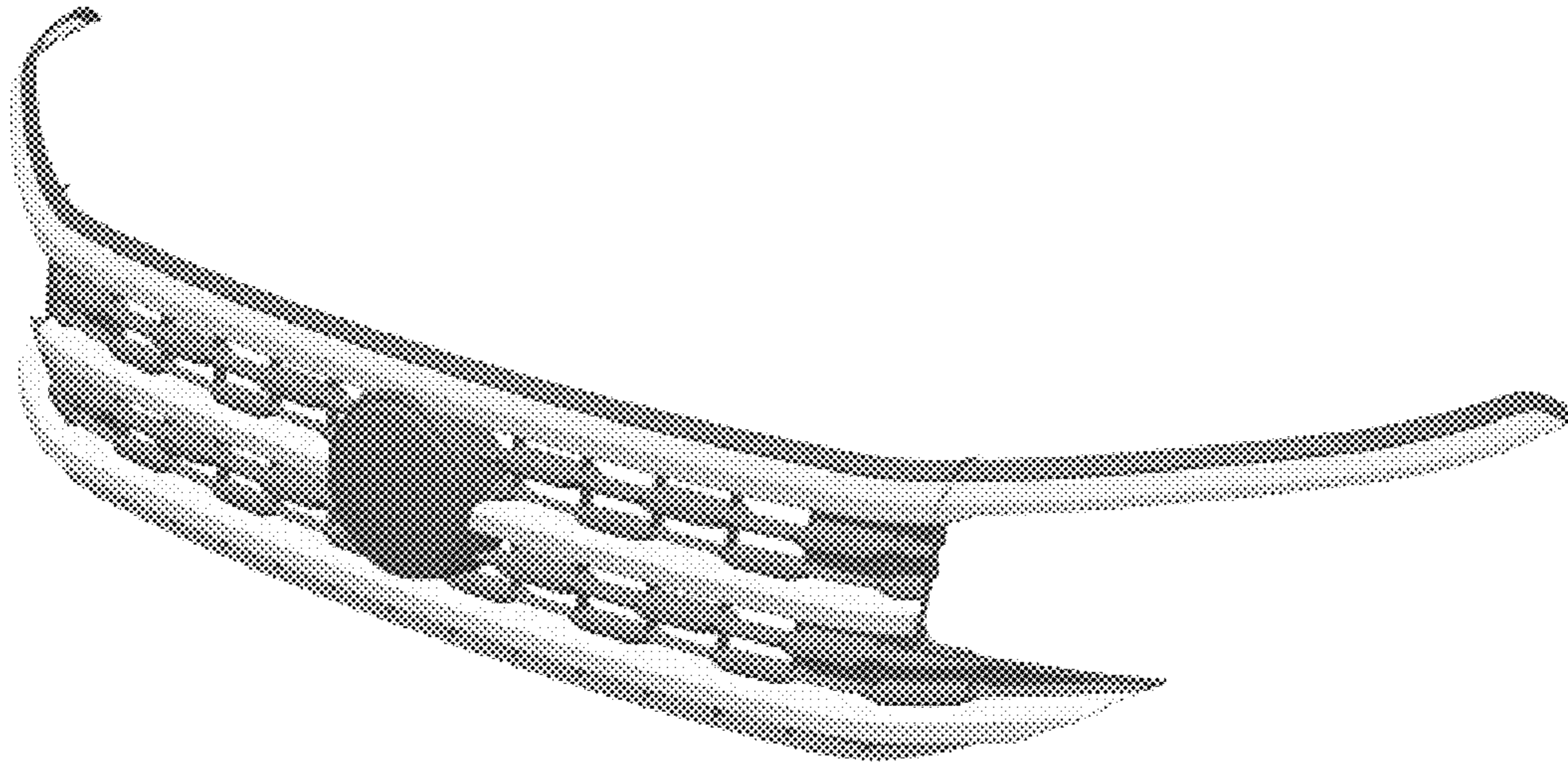

**Fig. 1**

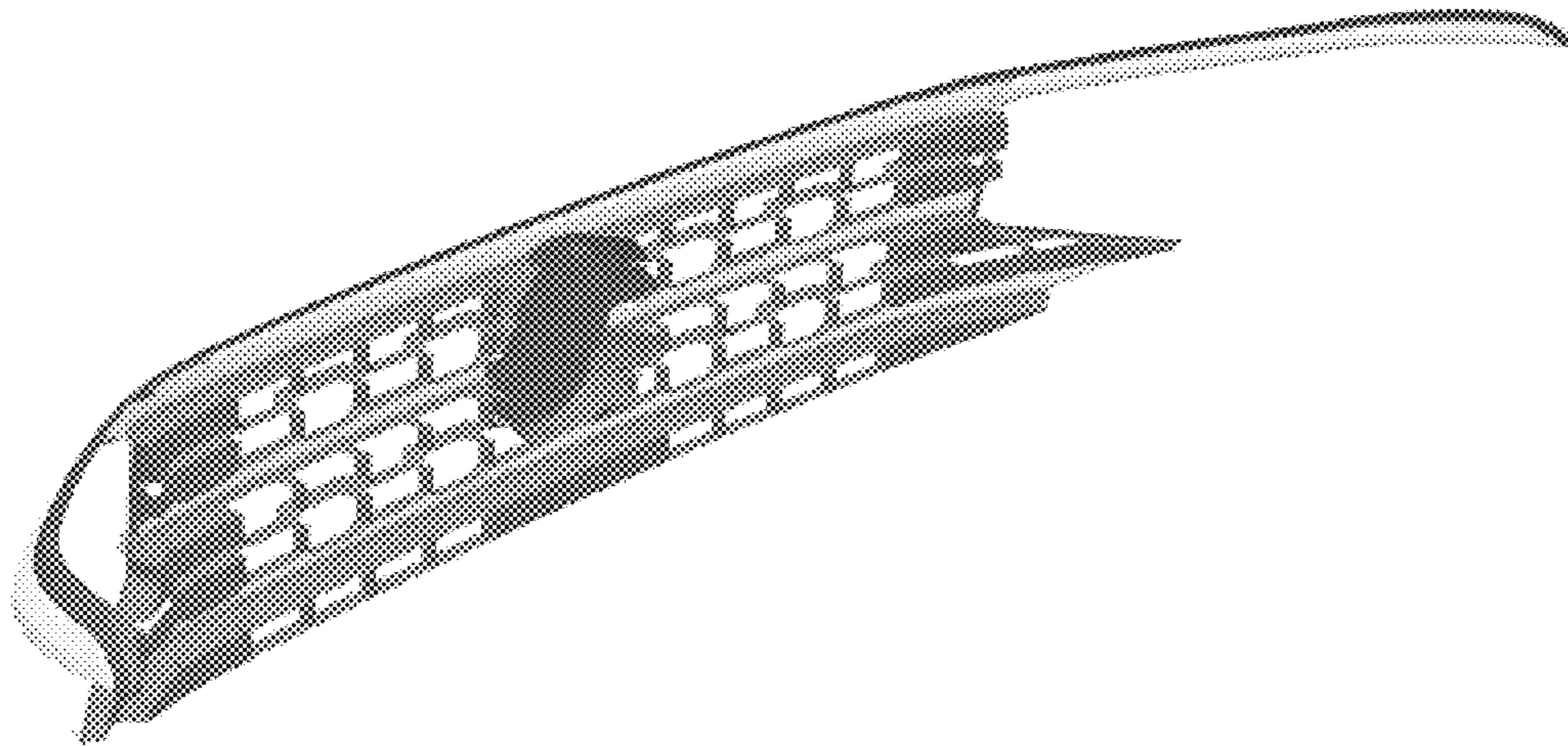

**Fig. 2**

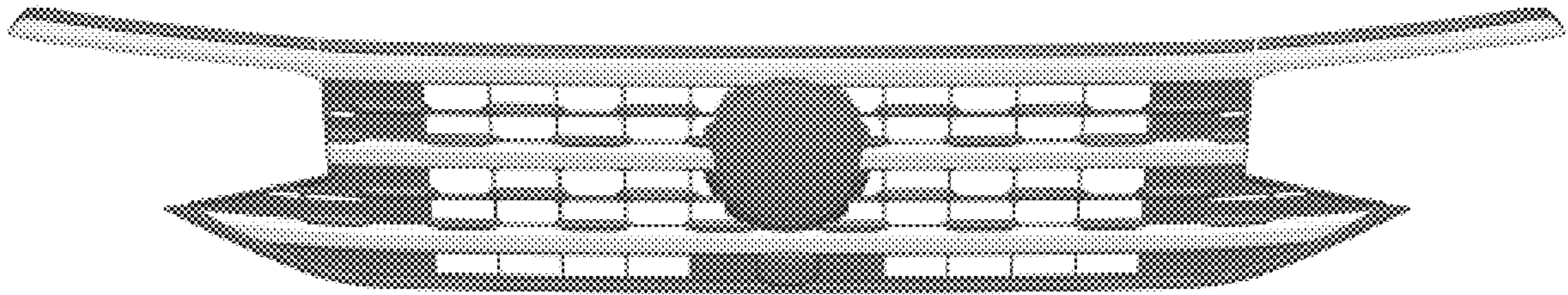

Fig. 3

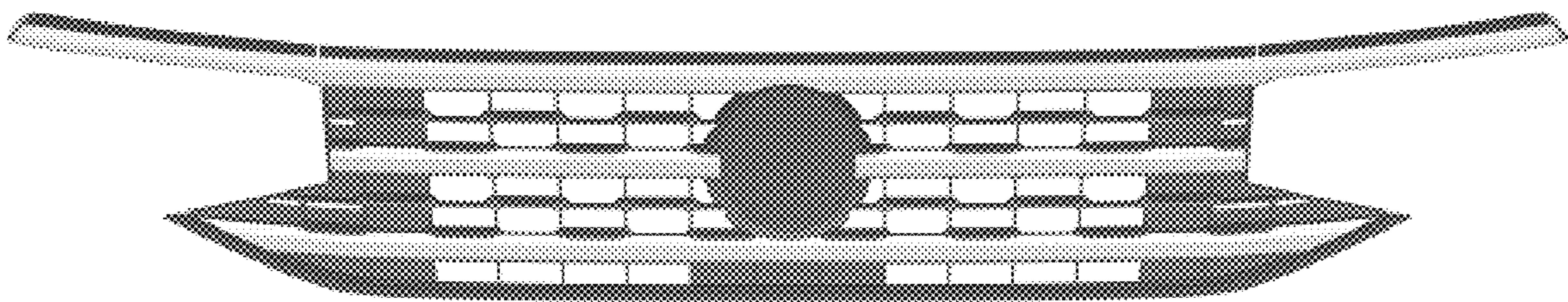
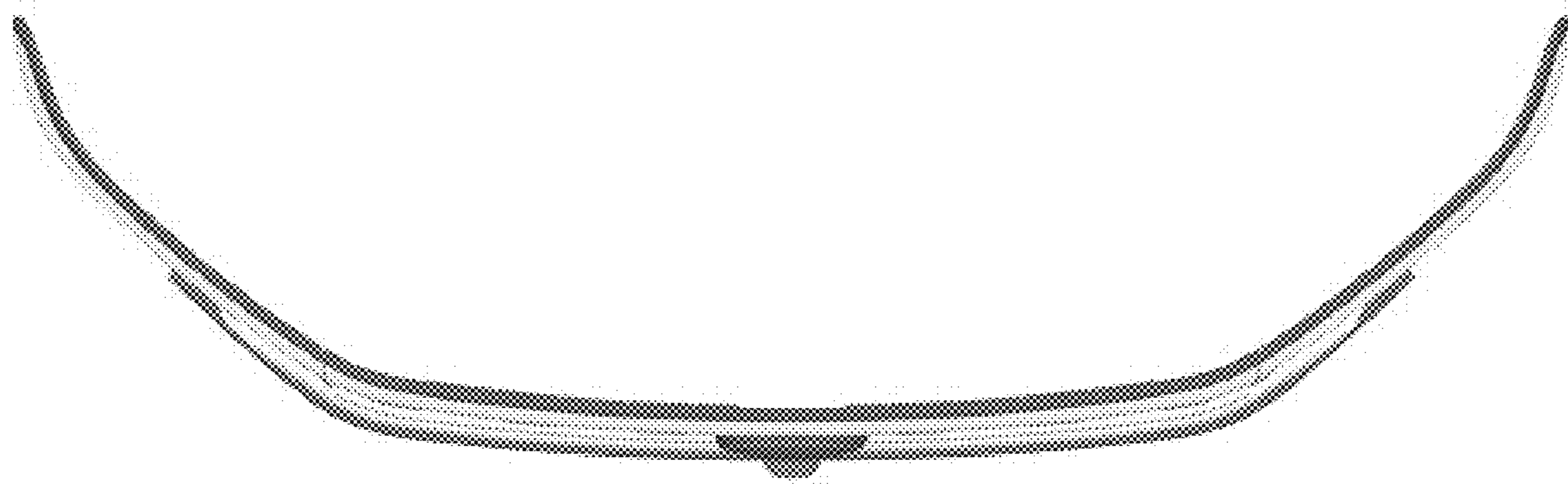
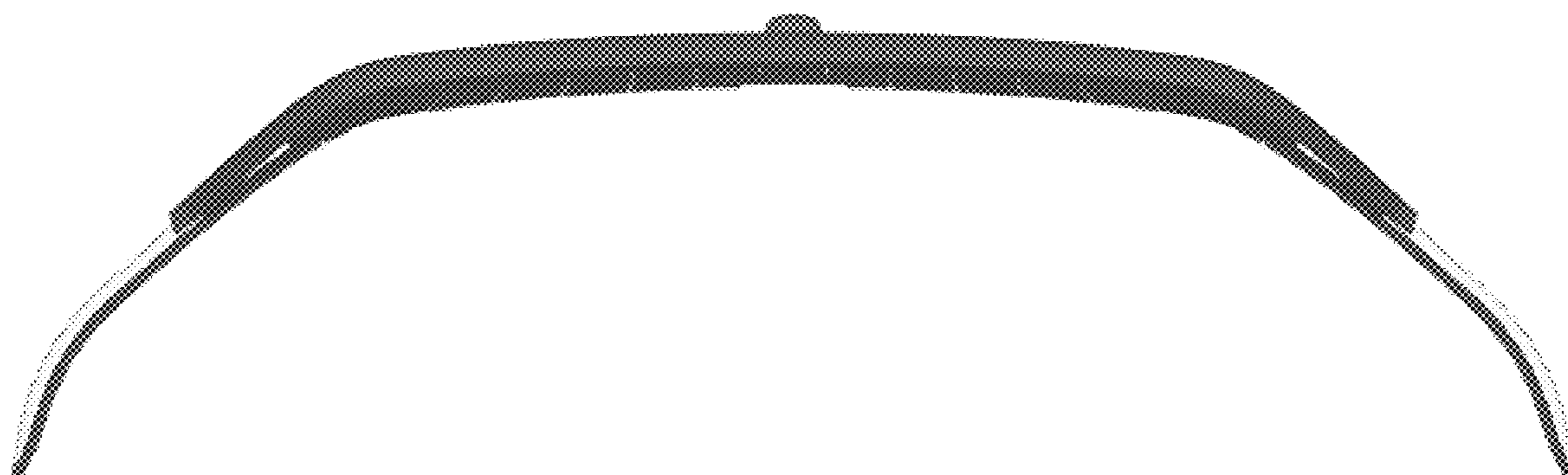

Fig. 4



**Fig. 5**



**Fig. 6**

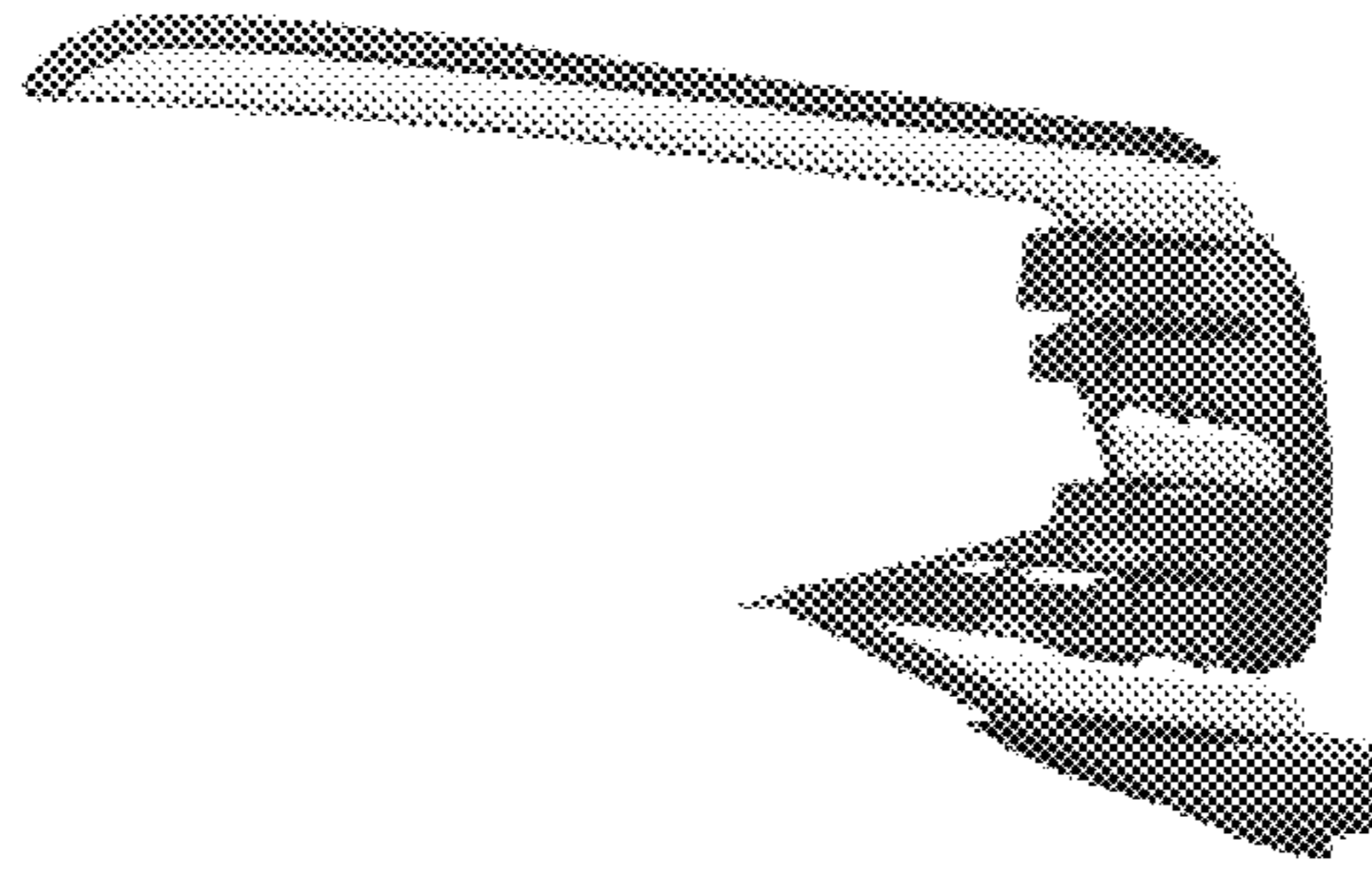

**Fig. 7**

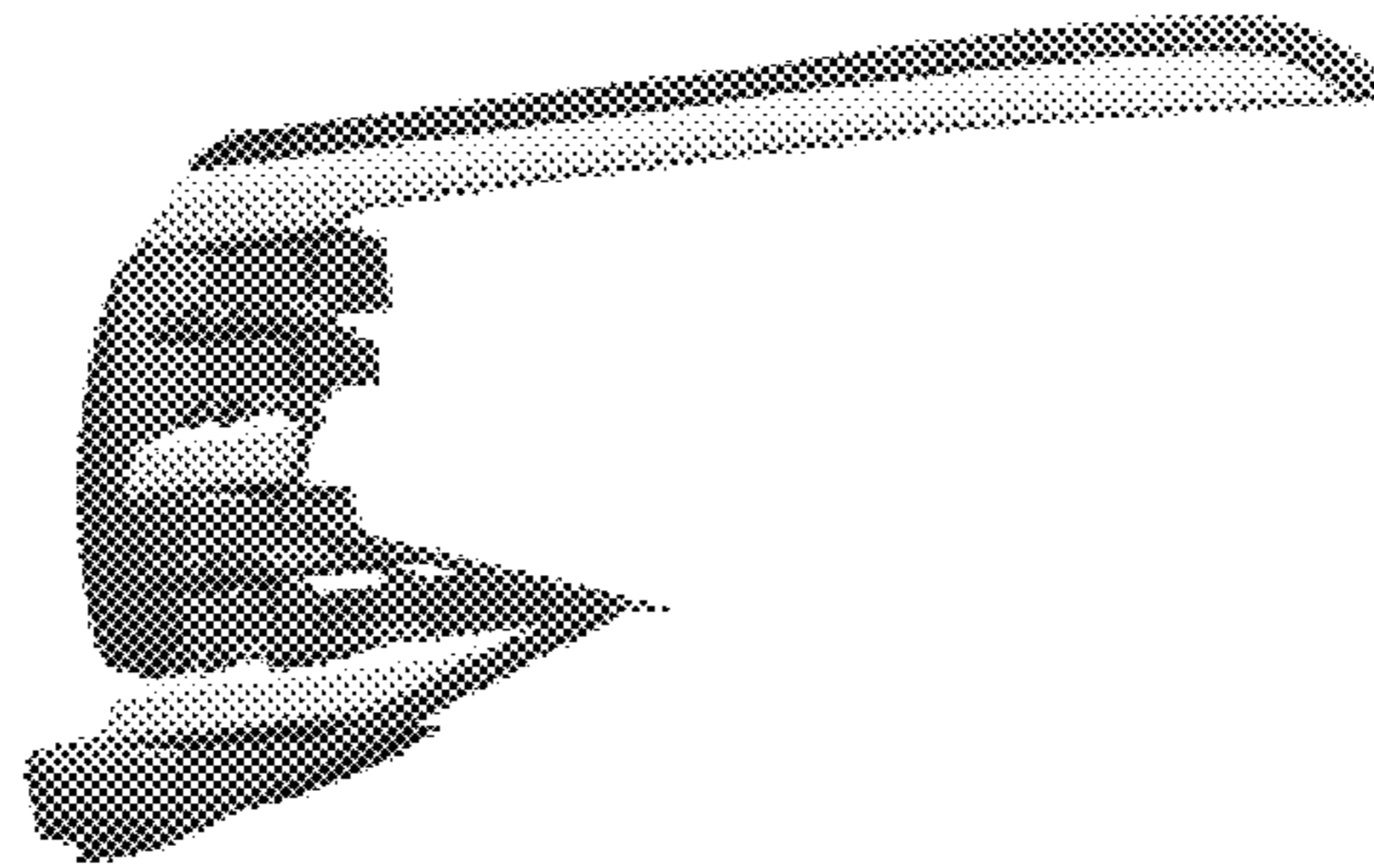

**Fig. 8**