



US00D908233S

(12) **United States Design Patent** (10) **Patent No.:** **US D908,233 S**
Zhou (45) **Date of Patent:** **** Jan. 19, 2021**

(54) **ULTRASONIC BEAUTY DEVICE**
(71) Applicant: **TOUCHBEAUTY BEAUTY & HEALTH (SHENZHEN) CO., LTD.,**
Shenzhen (CN)
(72) Inventor: **Elin Zhou, Shenzhen (CN)**
(73) Assignee: **TOUCHBEAUTY BEAUTY & HEALTH (SHENZHEN) CO., LTD.,**
Shenzhen (CN)
(**) Term: **15 Years**
(21) Appl. No.: **29/659,451**
(22) Filed: **Aug. 9, 2018**
(51) **LOC (13) Cl.** **24-01**
(52) **U.S. Cl.**
USPC **D24/214**
(58) **Field of Classification Search**
USPC D24/107, 186, 158, 231, 200, 209, 210,
D24/133, 187, 152, 167, 215, 214;
D26/29, 37, 39, 63, 104; D28/9, 44.1;
D14/341, 138 R, 138 AA, 138 G
CPC A61N 5/0616; A61N 5/0618; A61N
2005/0652; A61N 2005/0654; A61N
2005/0642; A61N 2005/0627; A61N
2005/0644; A61N 2005/0636; A61N
2005/0626; A61B 2018/00452; A61B
2018/1807
See application file for complete search history.

D855,195 S * 7/2019 Kymm D24/209
D857,196 S * 8/2019 Powell D24/133
D861,901 S * 10/2019 Matsushita D24/200
D865,990 S * 11/2019 Ko D24/215
D882,807 S * 4/2020 Xiong D24/214
2013/0109950 A1* 5/2013 Herzog A61B 8/0825
600/407

FOREIGN PATENT DOCUMENTS

RU 00077927 * 3/2011

OTHER PUBLICATIONS

Touch Beauty Ultrasonic Beauty Device, posted at urbanoutfitters.com, retrieved Dec. 4, 2019, no posting date, retrieved Dec. 4, 2019, online, URL: <https://www.urbanoutfitters.com/shop/touchbeauty-ultrasonic-beauty-device> (Year: 2019).*

* cited by examiner

Primary Examiner — Lilyana Bekic
Assistant Examiner — Mary Shannon Malley
(74) *Attorney, Agent, or Firm* — Juan Carlos A. Marquez;
Marquez IP Law Office, PLLC

(57) **CLAIM**

The ornamental design for an ultrasonic beauty device, as shown and described.

DESCRIPTION

FIG. 1 is a perspective view of an ultrasonic beauty device, showing my new design;
FIG. 2 is a front view thereof;
FIG. 3 is a rear view thereof;
FIG. 4 is a left-side view thereof;
FIG. 5 is a right-side view thereof;
FIG. 6 is a top view thereof; and,
FIG. 7 is a bottom view thereof.
The broken lines depict portions of the ultrasonic beauty device that form no part of the claimed design.

1 Claim, 5 Drawing Sheets

(56) **References Cited**
U.S. PATENT DOCUMENTS
D695,399 S * 12/2013 Sadot D24/133
D734,479 S * 7/2015 Youngquist D24/158
9,386,837 B2 * 7/2016 Geva A45D 34/042
D782,685 S * 3/2017 Pippel D24/186
D787,066 S * 5/2017 Kim D10/97
D787,074 S * 5/2017 Fang D24/186
D844,792 S * 4/2019 Choe D24/186
D855,194 S * 7/2019 Kymm D24/209

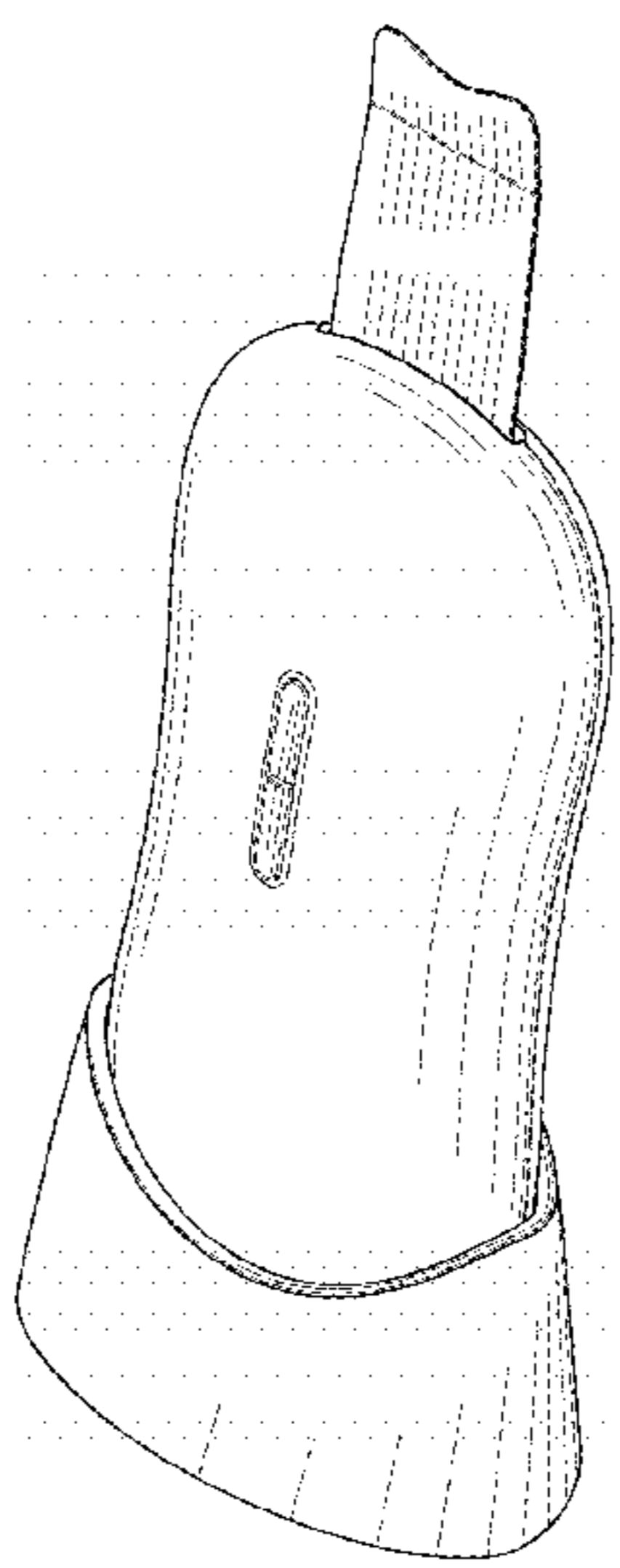

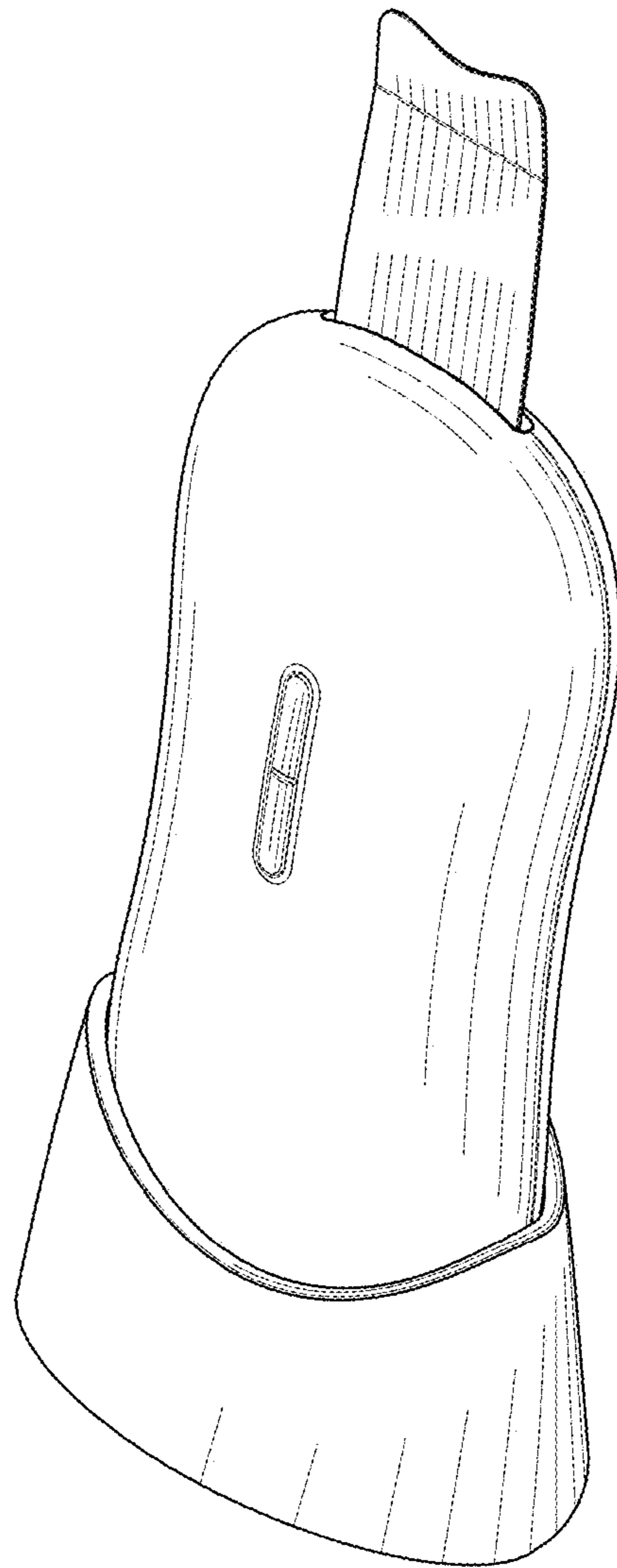

FIG. 1

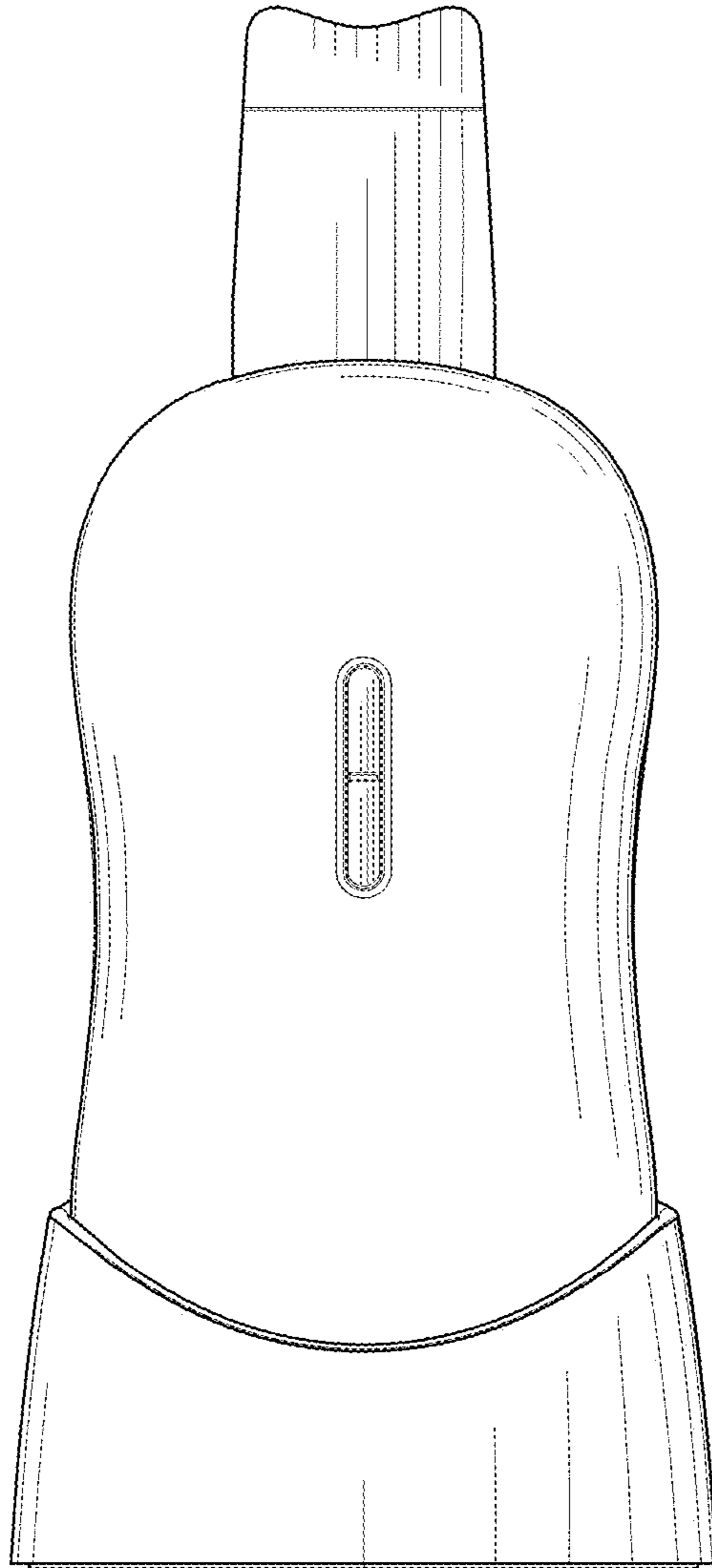

FIG. 2

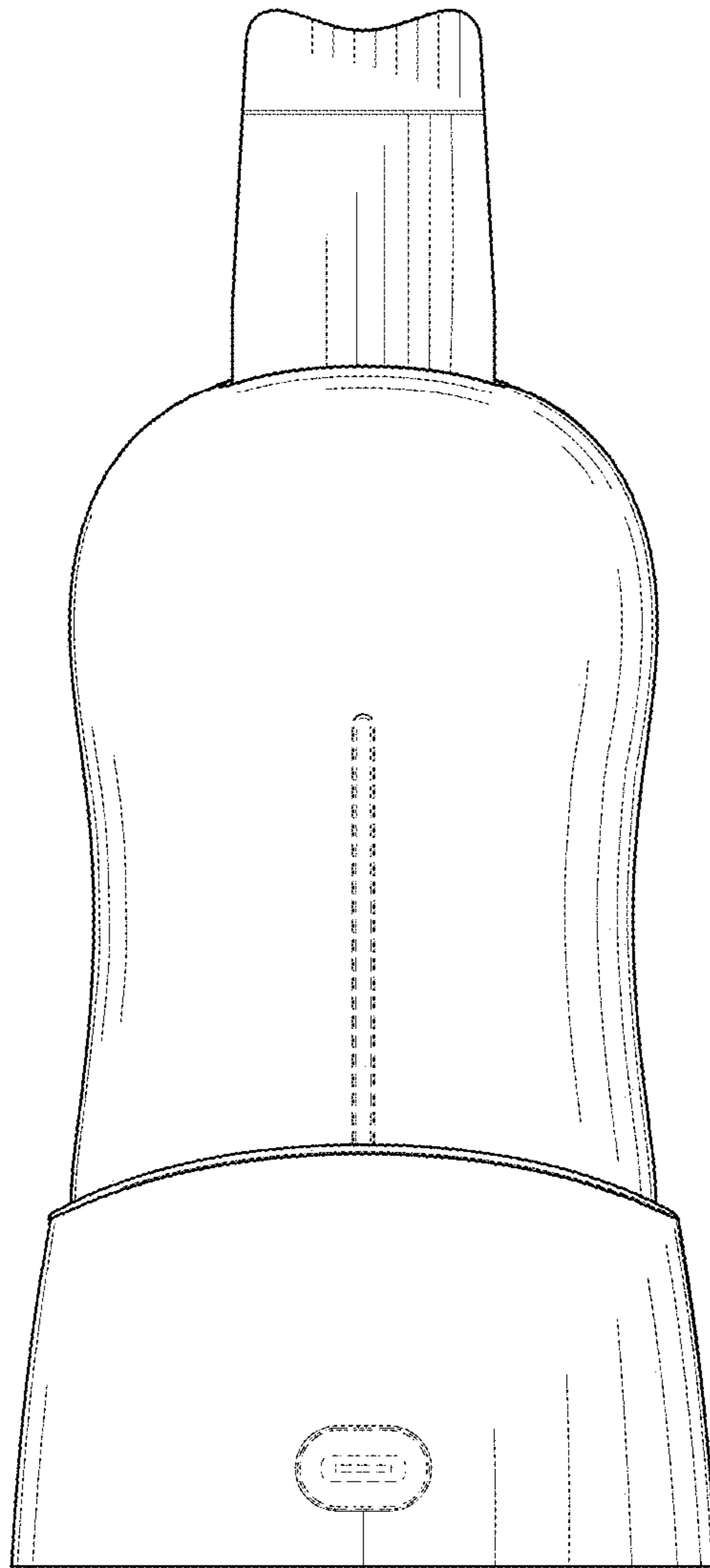

FIG. 3

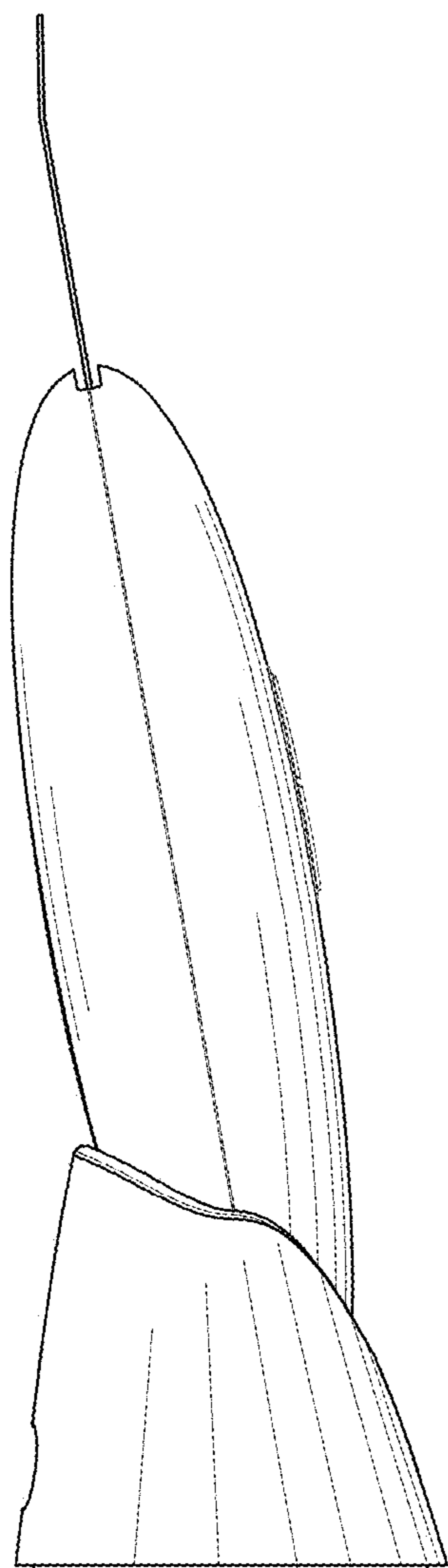

FIG. 4

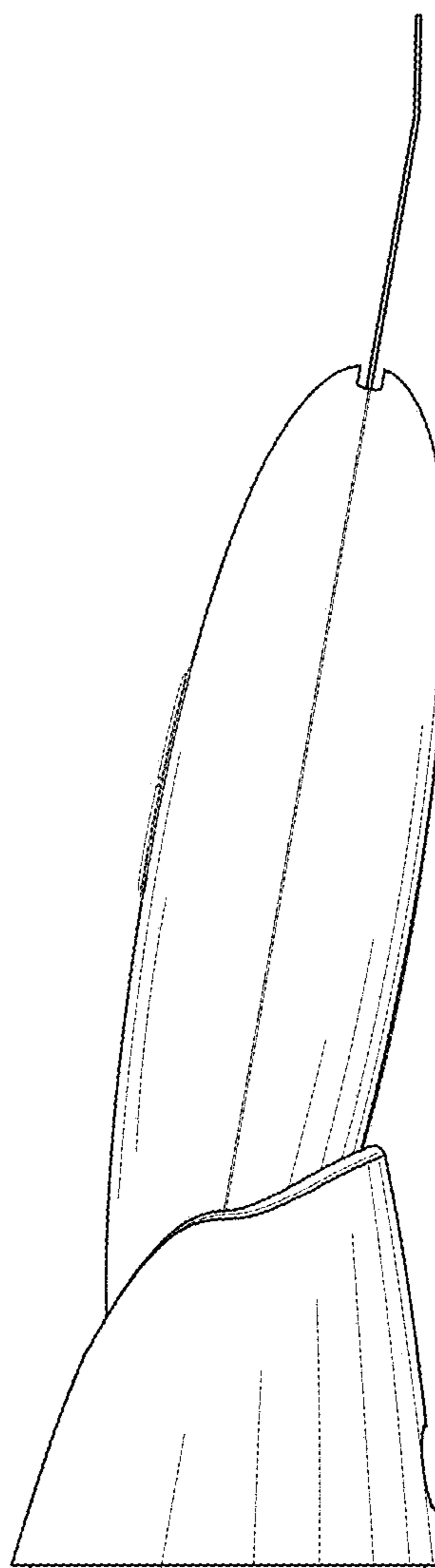

FIG. 5

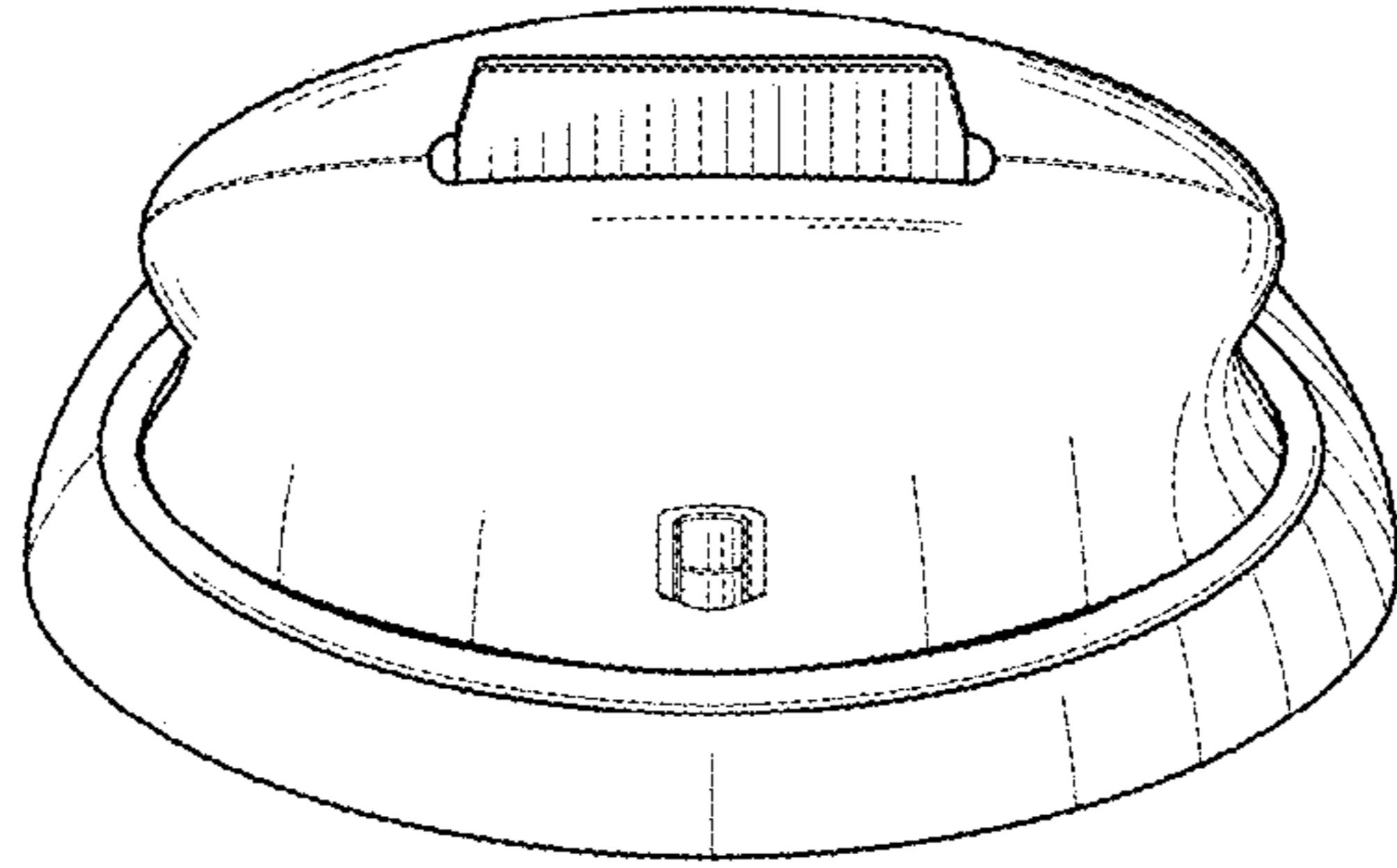

FIG. 6

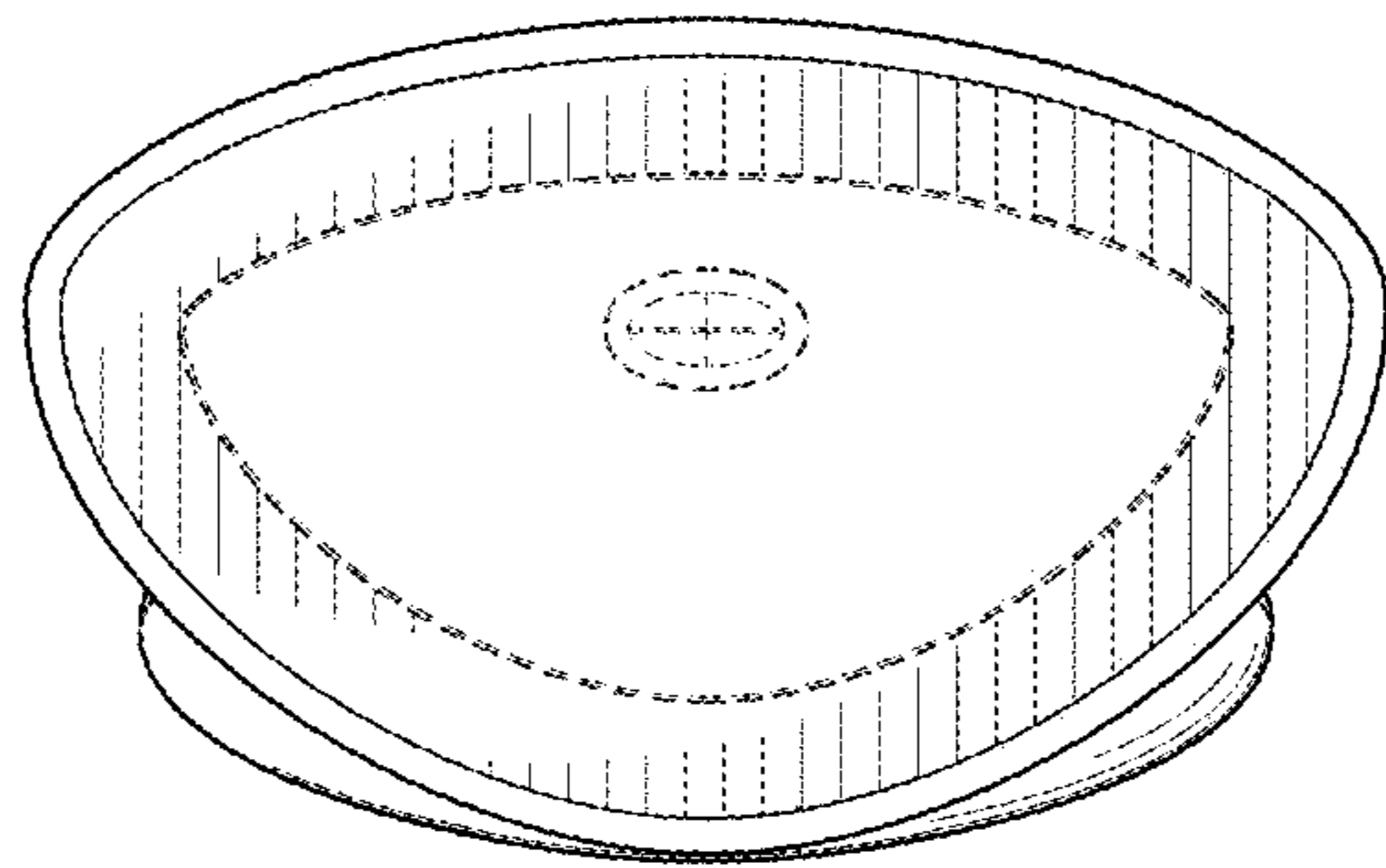

FIG. 7