



US00D908224S

(12) **United States Design Patent**
Huang et al.

(10) **Patent No.:** **US D908,224 S**

(45) **Date of Patent:** **** Jan. 19, 2021**

(54) **COMPONENT FOR PATIENT TABLE**

(71) Applicant: **Siemens Healthcare GmbH**, Erlangen (DE)

(72) Inventors: **Jian Bin Huang**, Shanghai (CN); **Hong Shang**, Shanghai (CN); **Zhong Yang Yu**, Shanghai (CN)

(73) Assignee: **Siemens Healthcare GmbH**, Erlangen (DE)

(**) Term: **15 Years**

(21) Appl. No.: **29/672,853**

(22) Filed: **Dec. 10, 2018**

(30) **Foreign Application Priority Data**

Jun. 11, 2018 (CN) 2018 3 0292414

(51) **LOC (13) Cl.** **24-02**

(52) **U.S. Cl.**
USPC **D24/184**; D24/183

(58) **Field of Classification Search**
USPC D24/159, 183-185, 199, 200, 212, 213;
D6/349-350, 353, 382-385
CPC A61G 7/00; A61G 7/0507; A47D 13/00;
A47D 13/08; A47D 13/083; A47K 17/00
See application file for complete search history.

(56) **References Cited**

U.S. PATENT DOCUMENTS

D258,236 S * 2/1981 Barnes D24/184
D313,521 S * 1/1991 Hassel D6/349

D555,247 S * 11/2007 Castellini D24/177
D597,754 S * 8/2009 Lukic D6/349
D663,428 S * 7/2012 Goransson D24/184
D791,337 S * 7/2017 Taylor B01L 3/50855
D858,783 S * 9/2019 Ci D24/200
2010/0229306 A1* 9/2010 Reeder, Jr. A47D 13/08
5/637

* cited by examiner

Primary Examiner — Susan Bennett Hattan

Assistant Examiner — Omeed Agilee

(74) *Attorney, Agent, or Firm* — Schiff Hardin LLP

(57) **CLAIM**

The ornamental design for a component for patient table, as shown and described.

DESCRIPTION

FIG. 1 is a front view of a component for patient table showing our new design;
FIG. 2 is a back elevational view thereof;
FIG. 3 is a top plan view thereof;
FIG. 4 is a bottom plan view thereof;
FIG. 5 is a right side elevational view thereof;
FIG. 6 is a left side elevational view thereof;
FIG. 7 is a perspective view taken generally from the upper, front, left-hand side thereof; and,
FIG. 8 is a perspective view taken generally from the upper, back, right-hand side thereof.
The broken lines depict portions of the component for patient table that form no part of the claimed design.

1 Claim, 8 Drawing Sheets

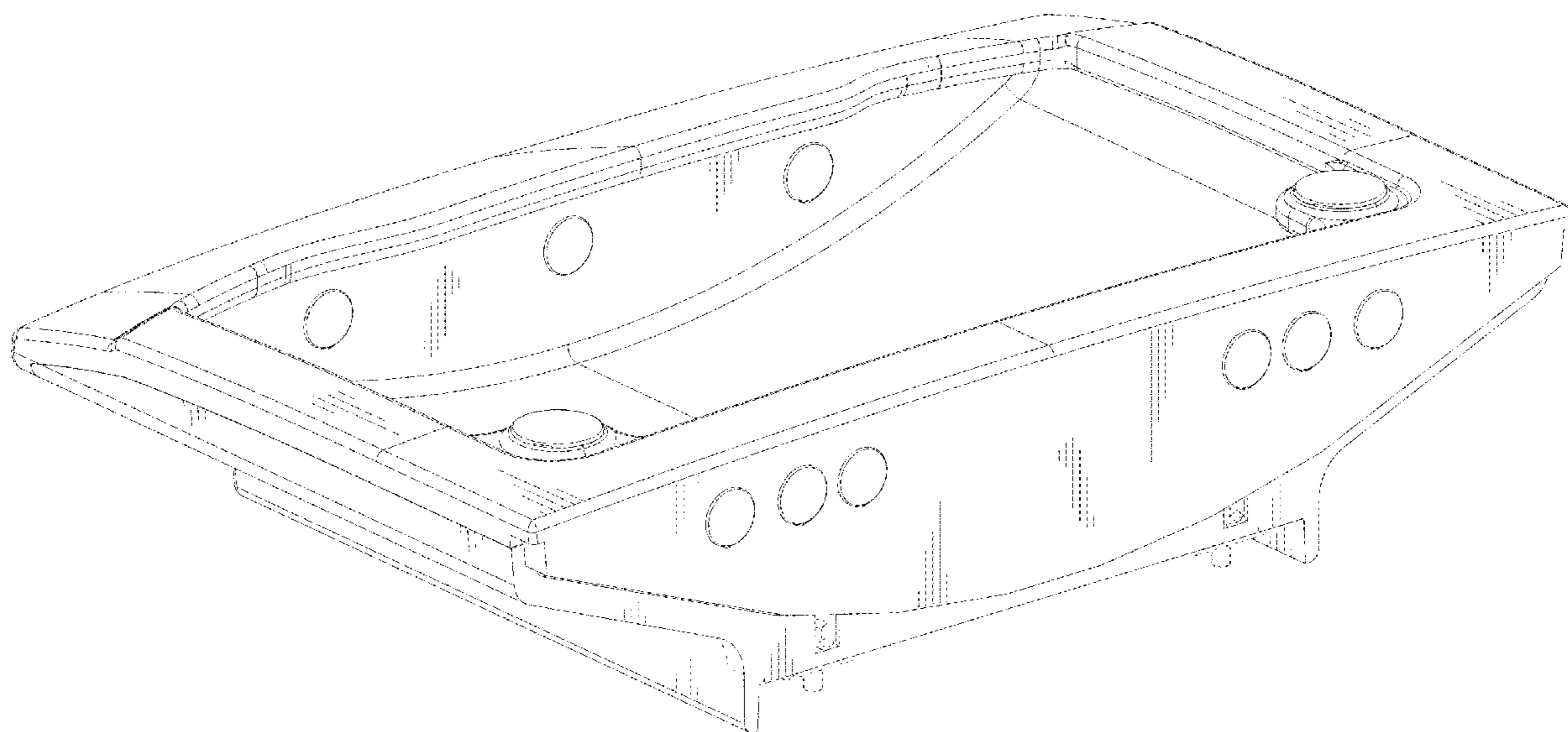

FIG. 1

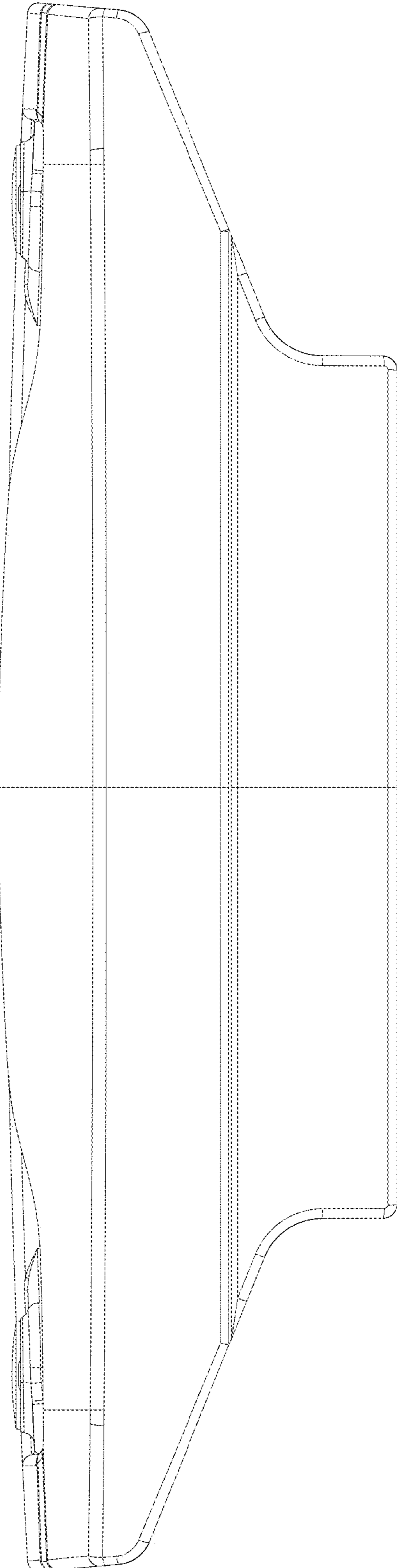

FIG. 2

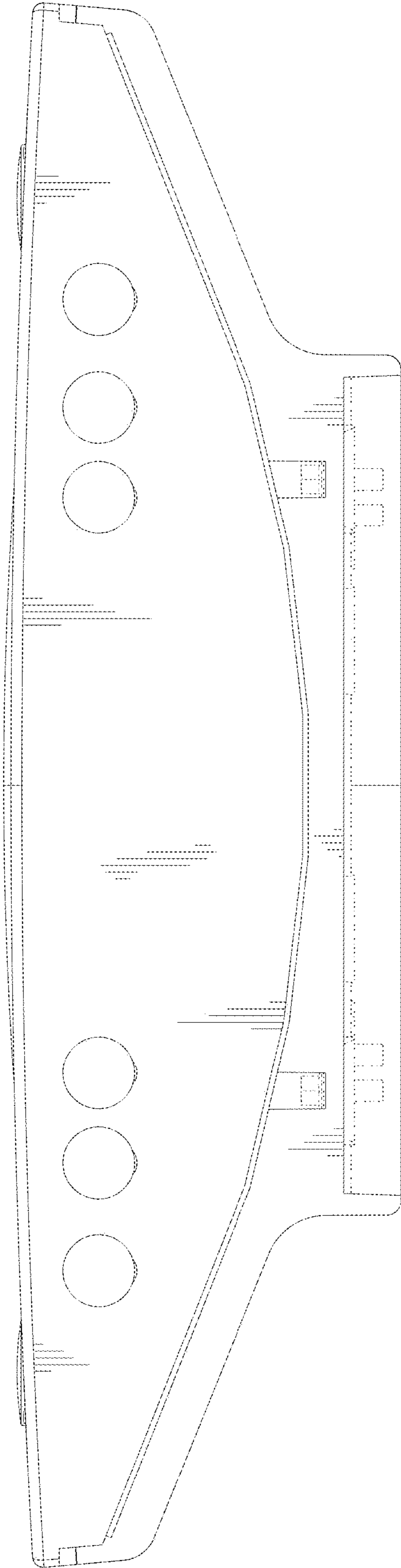

FIG. 3

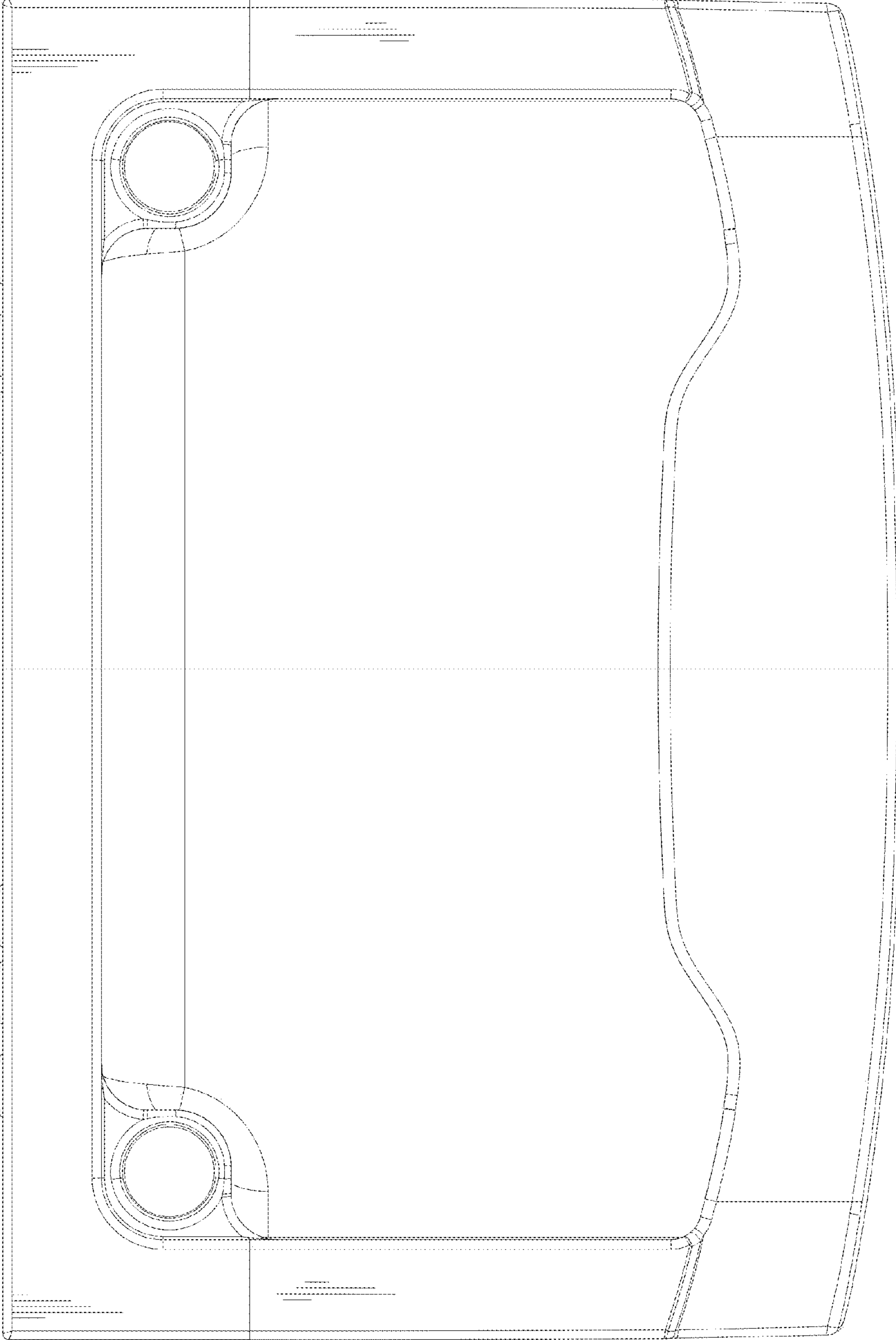

FIG. 4

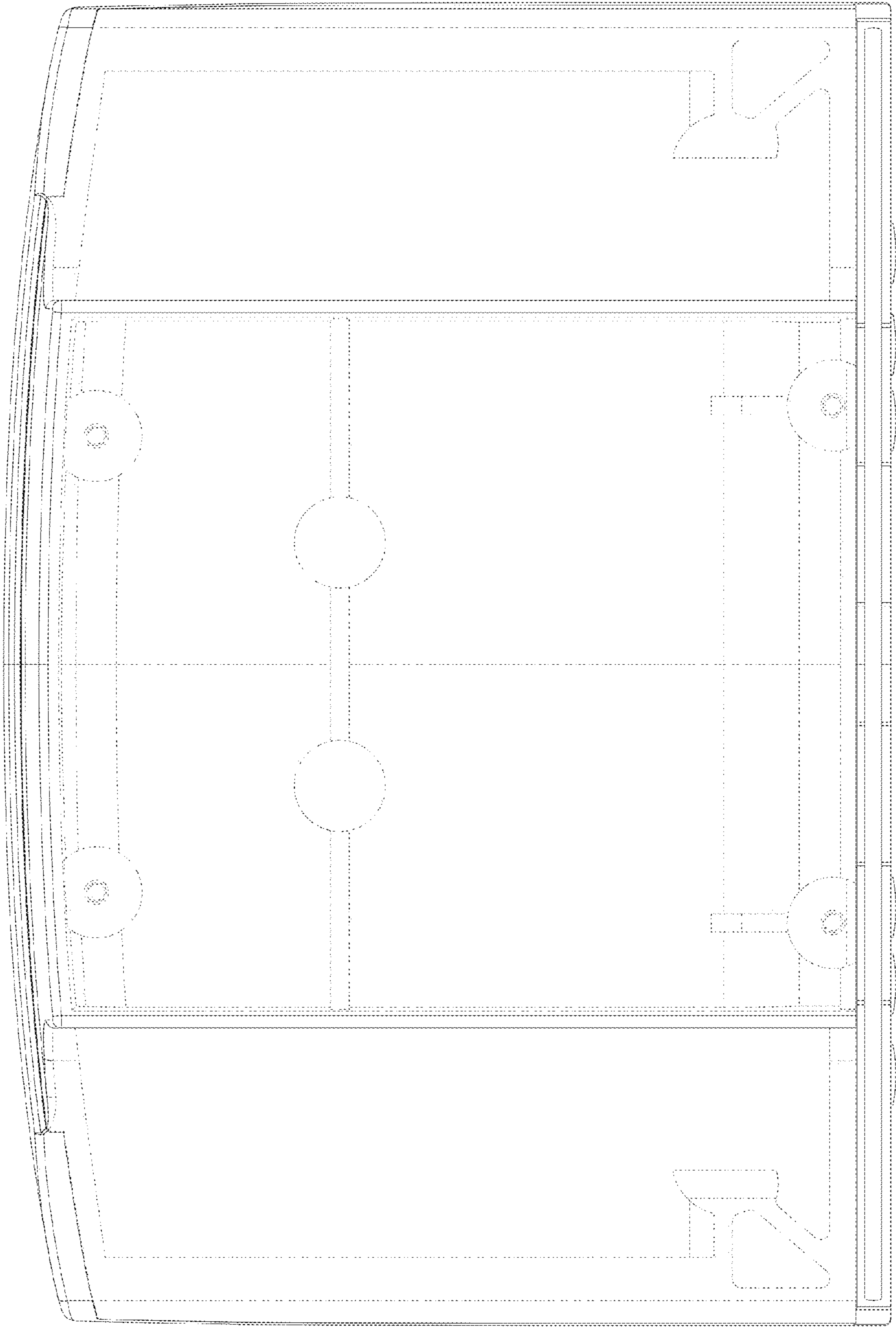

FIG. 5

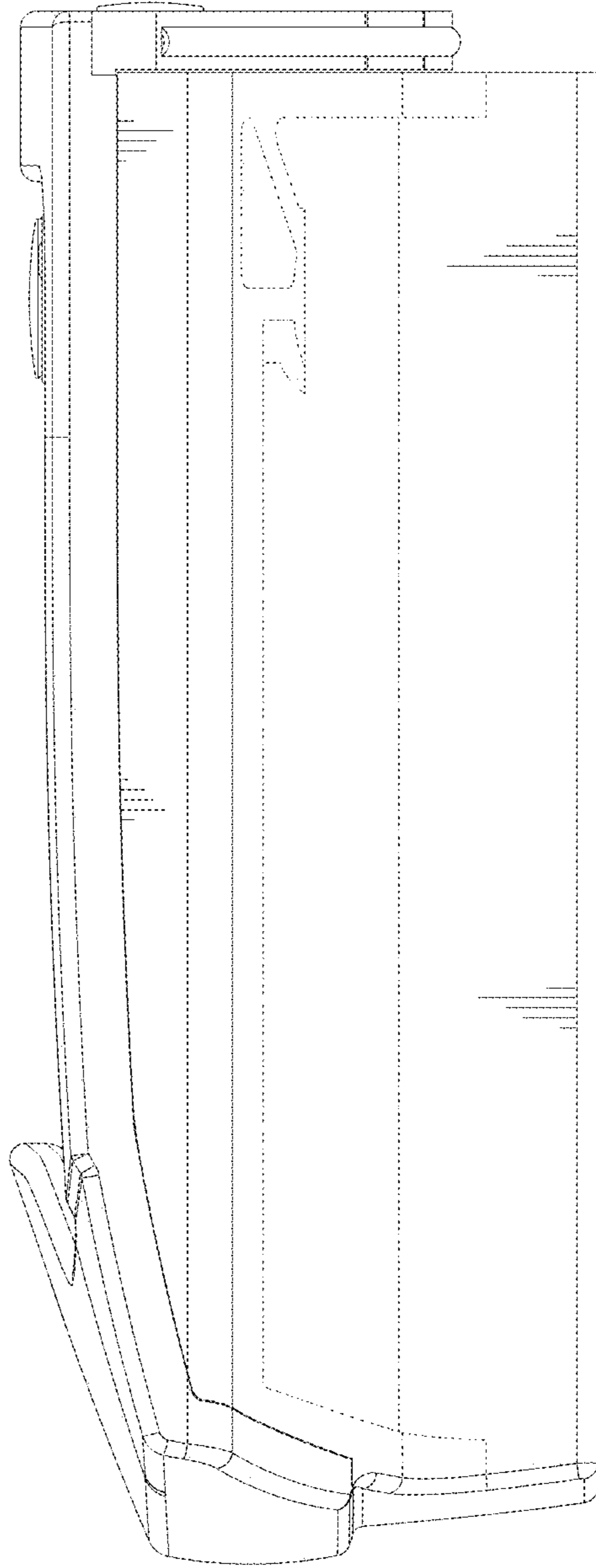

FIG. 6

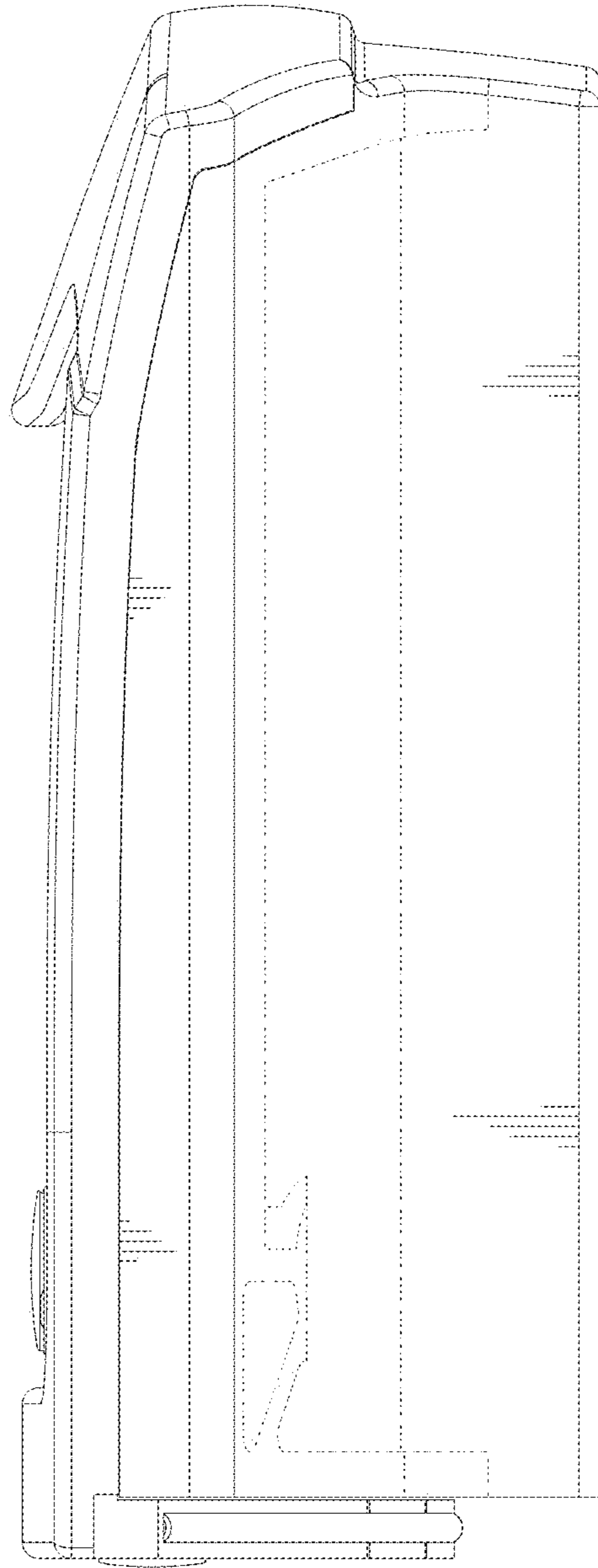

FIG. 7

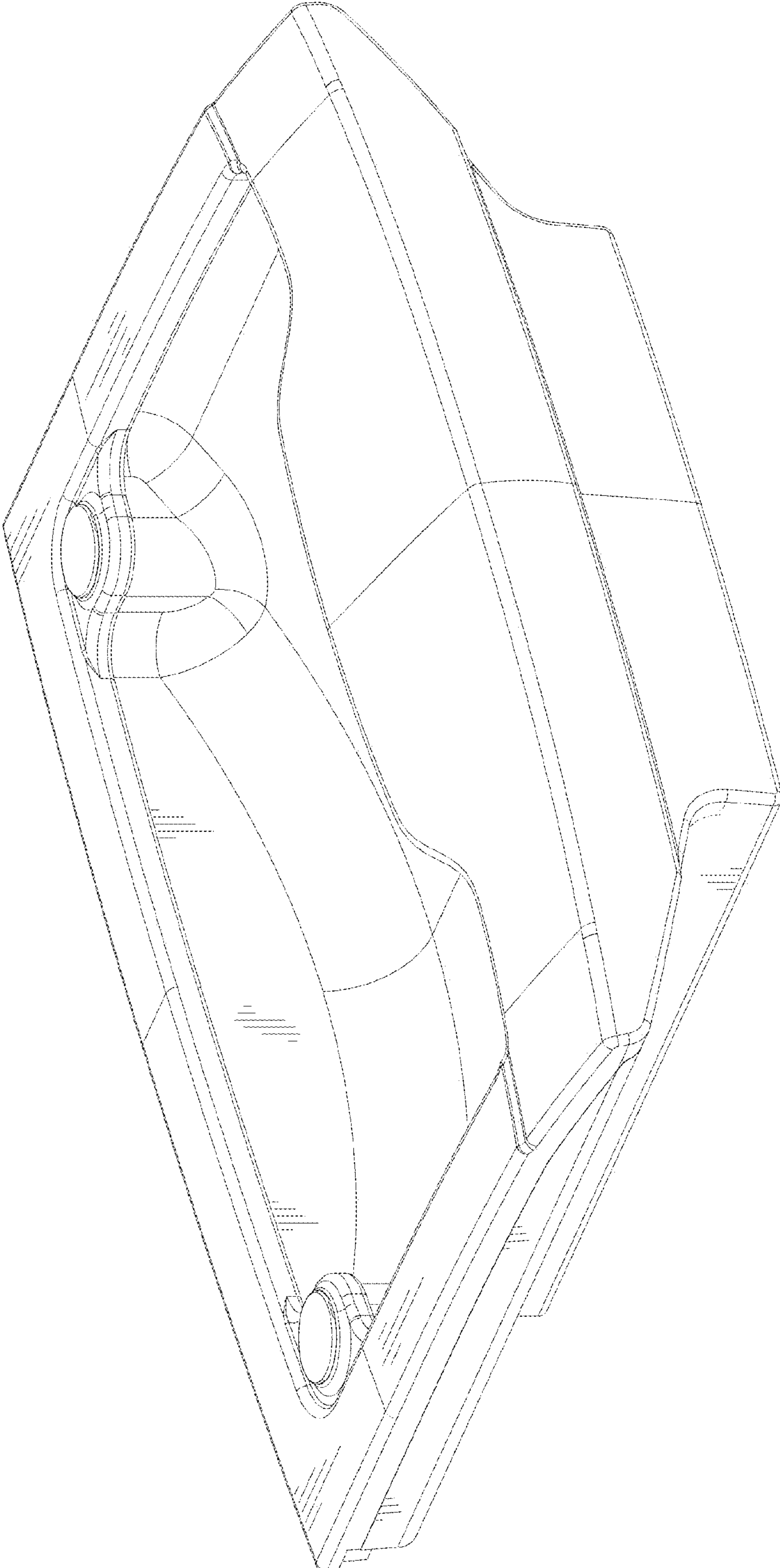

FIG. 8

