



US00D908214S

(12) **United States Design Patent** (10) **Patent No.:** **US D908,214 S**
Kaye et al. (45) **Date of Patent:** **** Jan. 19, 2021**

(54) **TIP PROTECTOR**
(71) Applicant: **United States Endoscopy Group, Inc.,**
Mentor, OH (US)
(72) Inventors: **Christopher J. Kaye**, Eastlake, OH
(US); **Gary Mann**, Mentor, OH (US)
(73) Assignee: **UNITED STATES ENDOSCOPY**
GROUP, INC., Mentor, OH (US)

8,998,854 B2 4/2015 McKay
8,999,291 B2 4/2015 Goodman et al.
8,999,365 B2 4/2015 Lane et al.
8,999,399 B2 4/2015 Lisowsky et al.
D736,915 S * 8/2015 Schultz D24/129
D751,699 S * 3/2016 Mills D24/127
D791,936 S * 7/2017 Davis D24/127
D825,750 S * 8/2018 Feldmann D24/130

(Continued)

FOREIGN PATENT DOCUMENTS

JP H05 15901 U 3/1993
JP 2007 075281 A 3/2007
WO 2016059383 4/2016

(**) Term: **15 Years**
(21) Appl. No.: **29/656,132**

(22) Filed: **Jul. 10, 2018**
(51) **LOC (13) Cl.** **24-02**
(52) **U.S. Cl.**
USPC **D24/130**
(58) **Field of Classification Search**
USPC D24/127-131, 112-114, 133, 186;
606/181, 185; 604/264, 523-528, 272,
604/187, 158, 164.01-164.11, 181, 184,
604/227; 600/101, 139, 143;
128/200.24, 207.14, 207.15
CPC A61M 39/1011; F16L 37/0841; F16L
2201/20; F16L 2201/60
See application file for complete search history.

OTHER PUBLICATIONS

Invitation to Pay Additional Fees from PCT/US2019/041243 dated
Sep. 26, 2019.

(Continued)

Primary Examiner — Nathan M Johnston
(74) *Attorney, Agent, or Firm* — Calfee, Halter &
Griswold LLP

(57) **CLAIM**

The ornamental design for a tip protector, as shown and
described.

DESCRIPTION

FIG. 1 is a perspective view of a tip protector of the new
design;
FIG. 2 is a right-side view thereof;
FIG. 3 is a left-side view thereof;
FIG. 4 is a front view thereof;
FIG. 5 is a rear view thereof;
FIG. 6 is a top view thereof; and,
FIG. 7 is a bottom view thereof.
The broken lines show portions of the design that form no
part of the claimed design.

(56) **References Cited**
U.S. PATENT DOCUMENTS
5,176,126 A * 1/1993 Chikama A61B 1/0055
138/120
6,045,623 A 4/2000 Cannon
7,757,689 B2 * 7/2010 Chang B08B 15/026
128/200.24
D639,939 S * 6/2011 Klockars D24/129
D649,635 S * 11/2011 Cronin D24/133
D690,418 S * 9/2013 Rosenquist D24/129
8,911,765 B2 12/2014 Moses et al.
8,951,543 B2 2/2015 Weiss et al.
D727,493 S * 4/2015 Biener D24/110.6

1 Claim, 7 Drawing Sheets

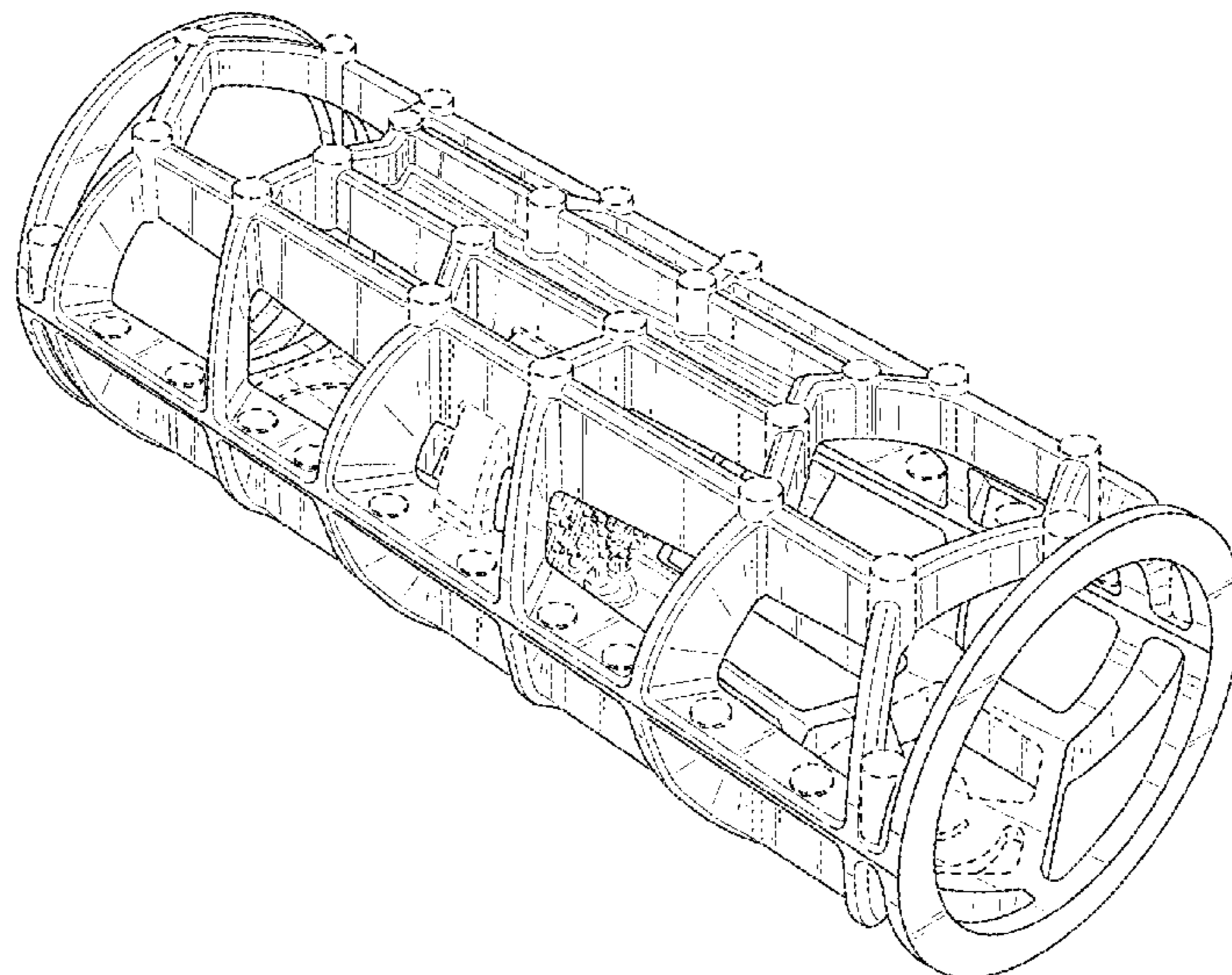

(56)

References Cited

U.S. PATENT DOCUMENTS

D859,650 S * 9/2019 Steele D24/129
D860,474 S * 9/2019 Kawabe D24/224
2002/0193741 A1 12/2002 Secrest
2009/0221872 A1 9/2009 Liddle et al.
2014/0343361 A1 11/2014 Salman et al.
2015/0069728 A1 3/2015 Seitz, III
2019/0282356 A1* 9/2019 Cully A61F 2/97

OTHER PUBLICATIONS

International Search Report and Written Opinion from Application
No. PCT/US2019/041243 dated Nov. 20, 2019 (18 pages).
Ruhof's ScopeValet™ TipGuard <https://www.ruhof.com/products/scopevalet-tipguard> Dec. 29, 2017 (1 page).

* cited by examiner

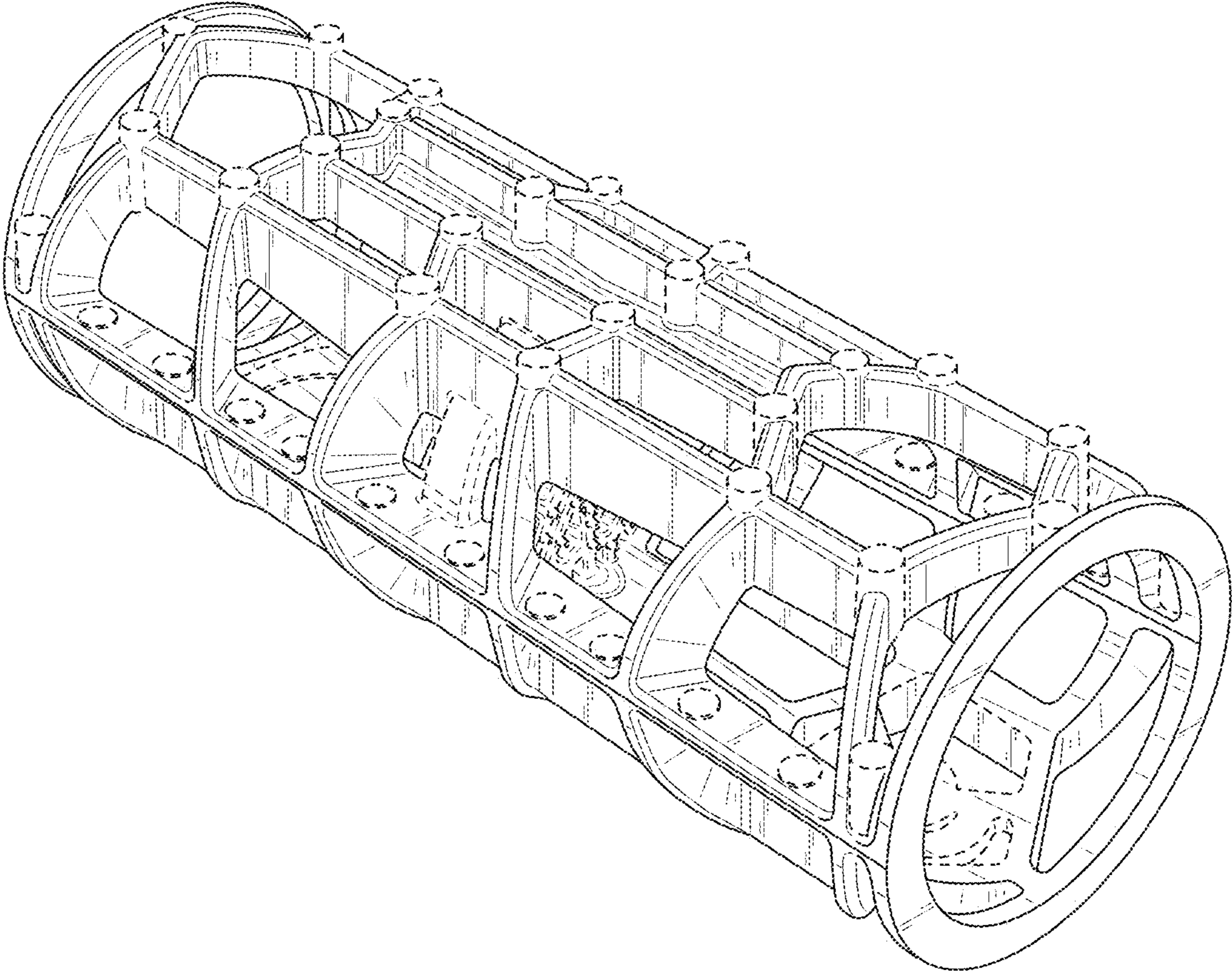

FIG. 1

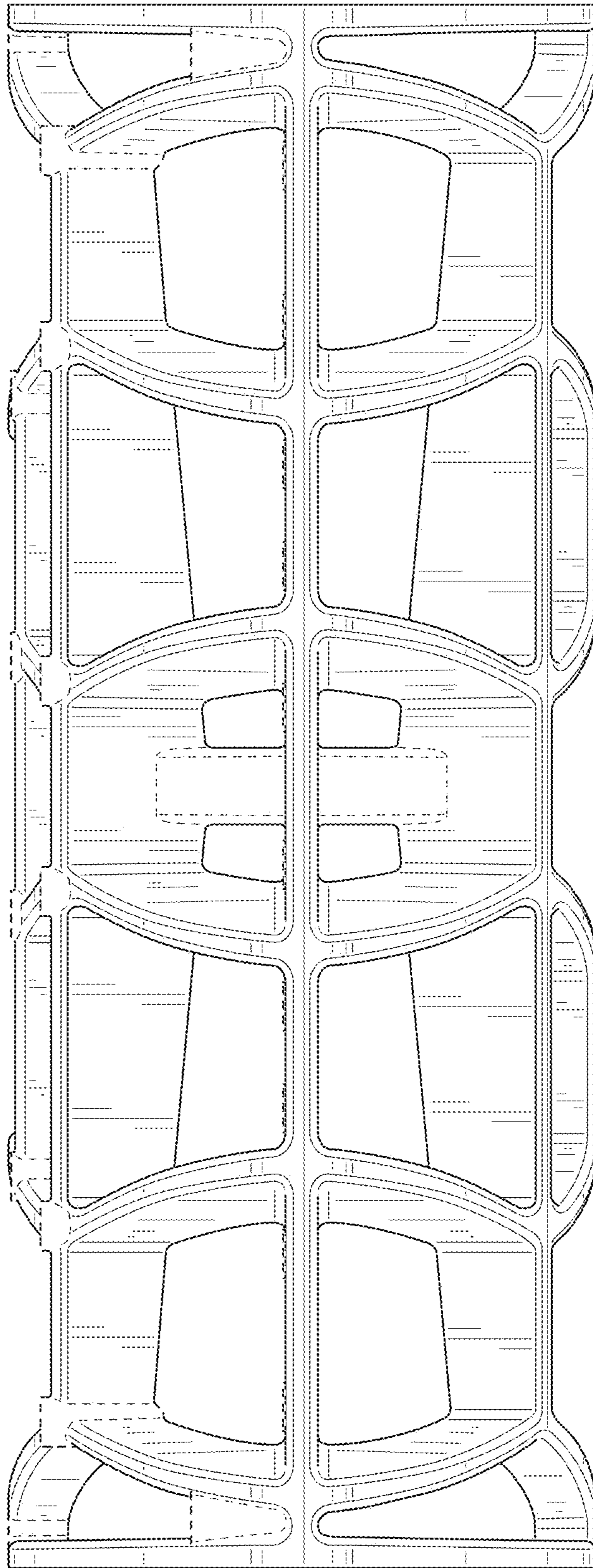

FIG. 2

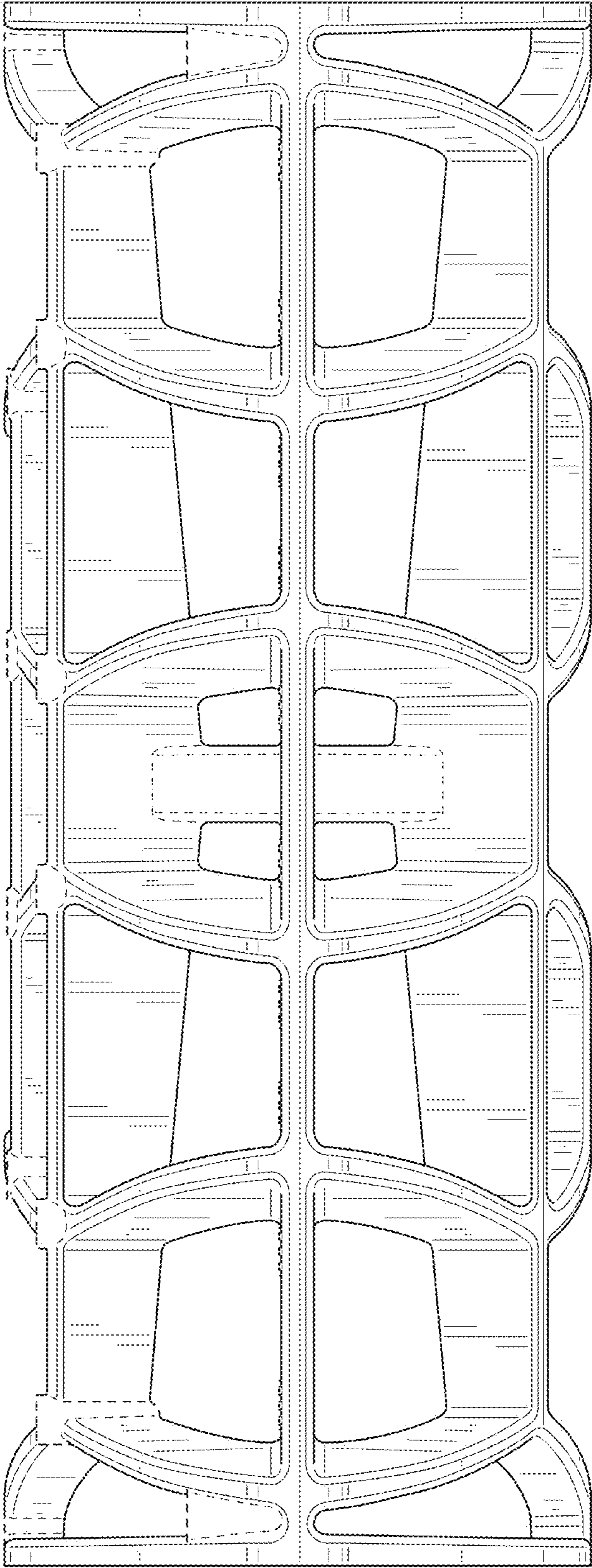

FIG. 3

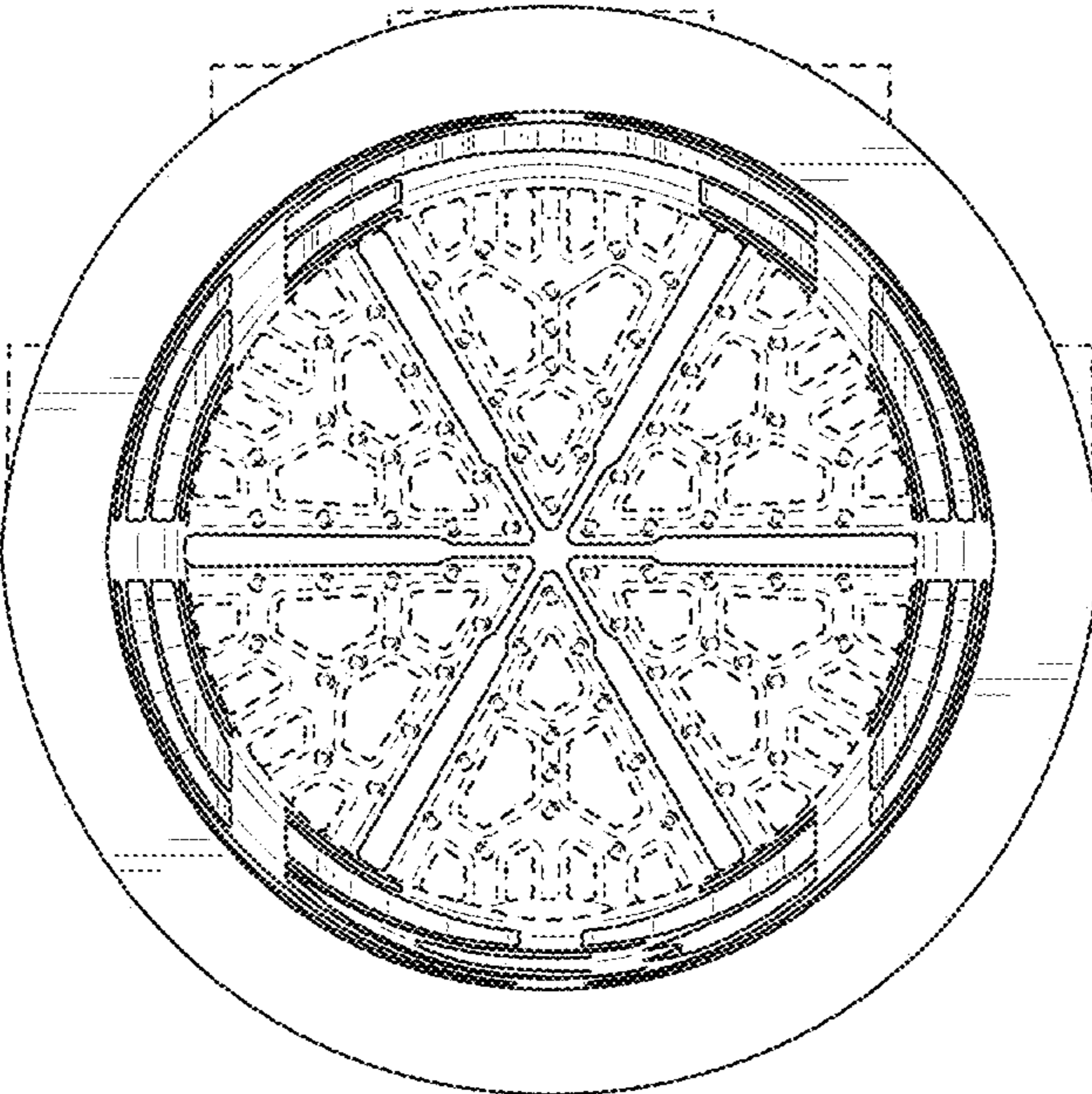

FIG. 4

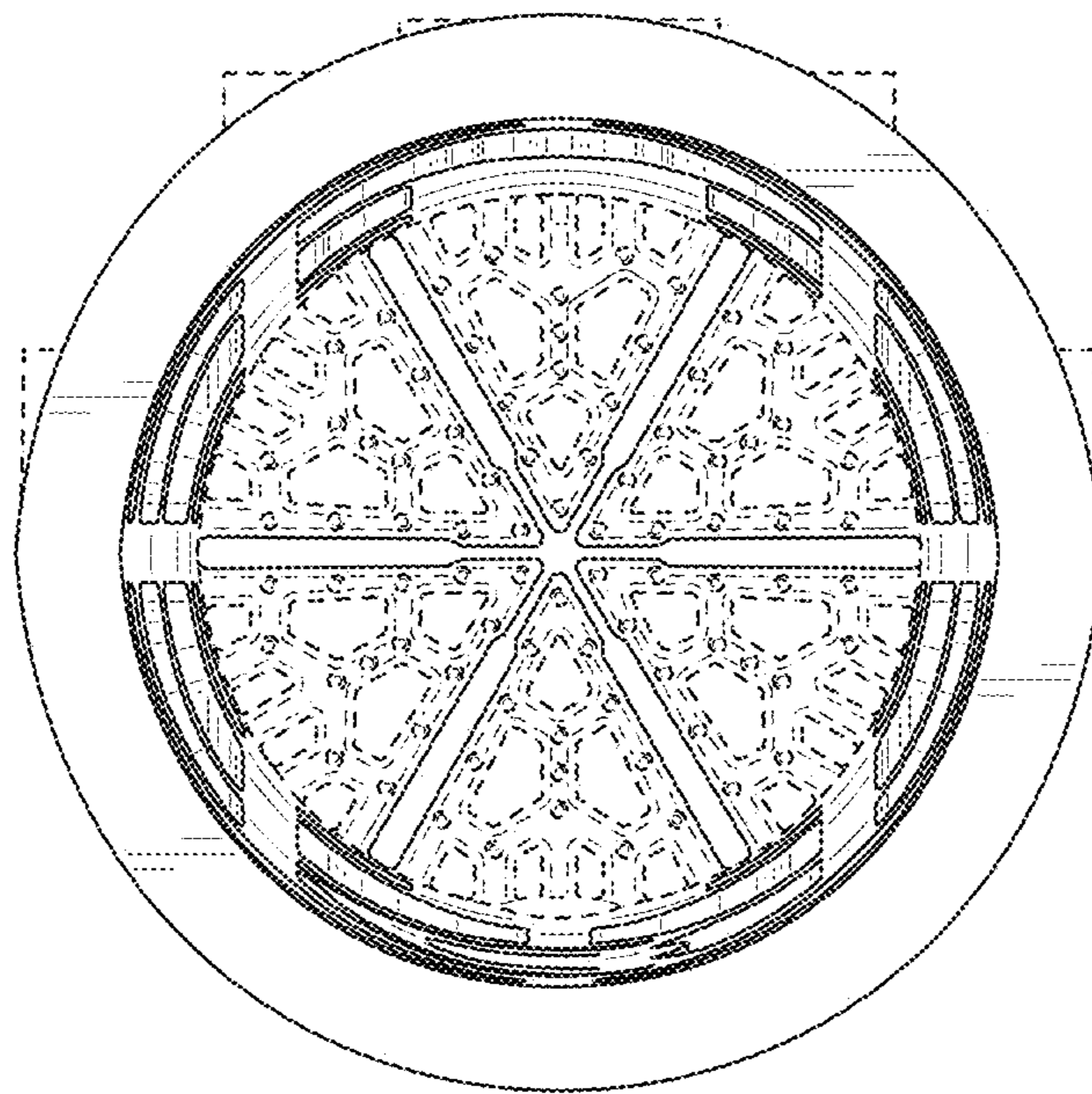

FIG. 5

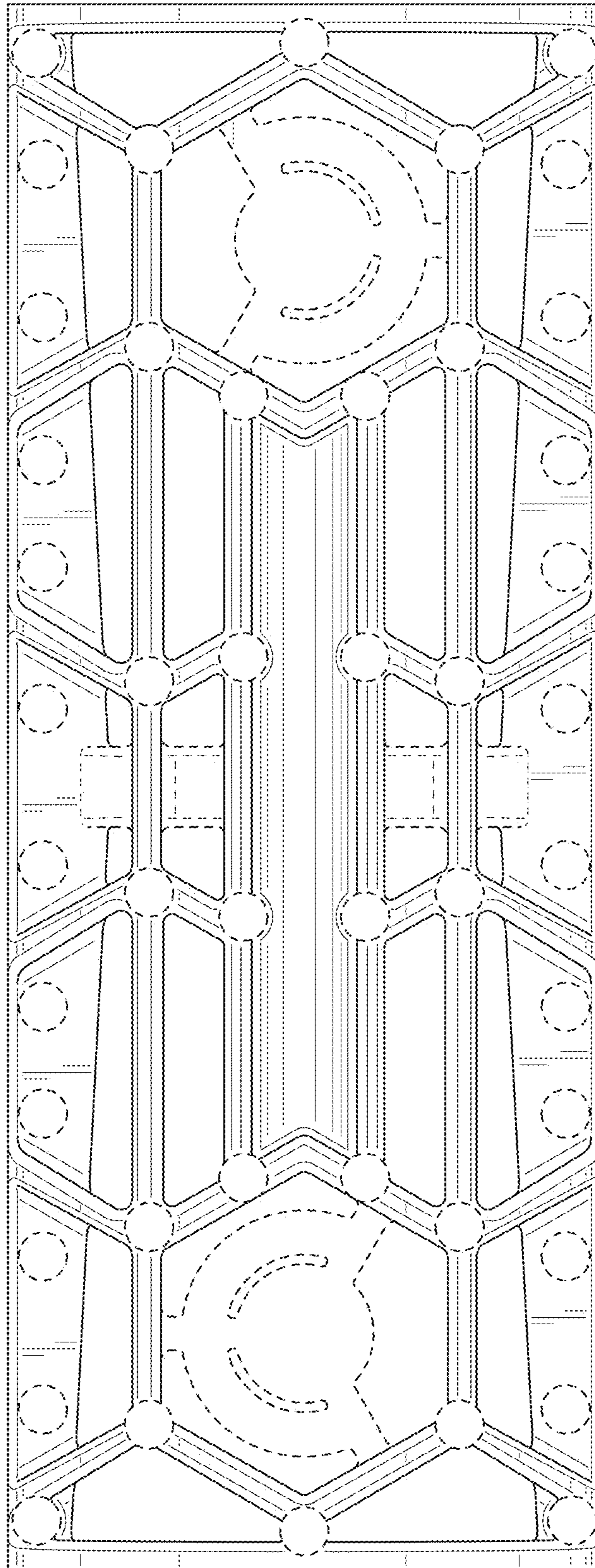

FIG. 6

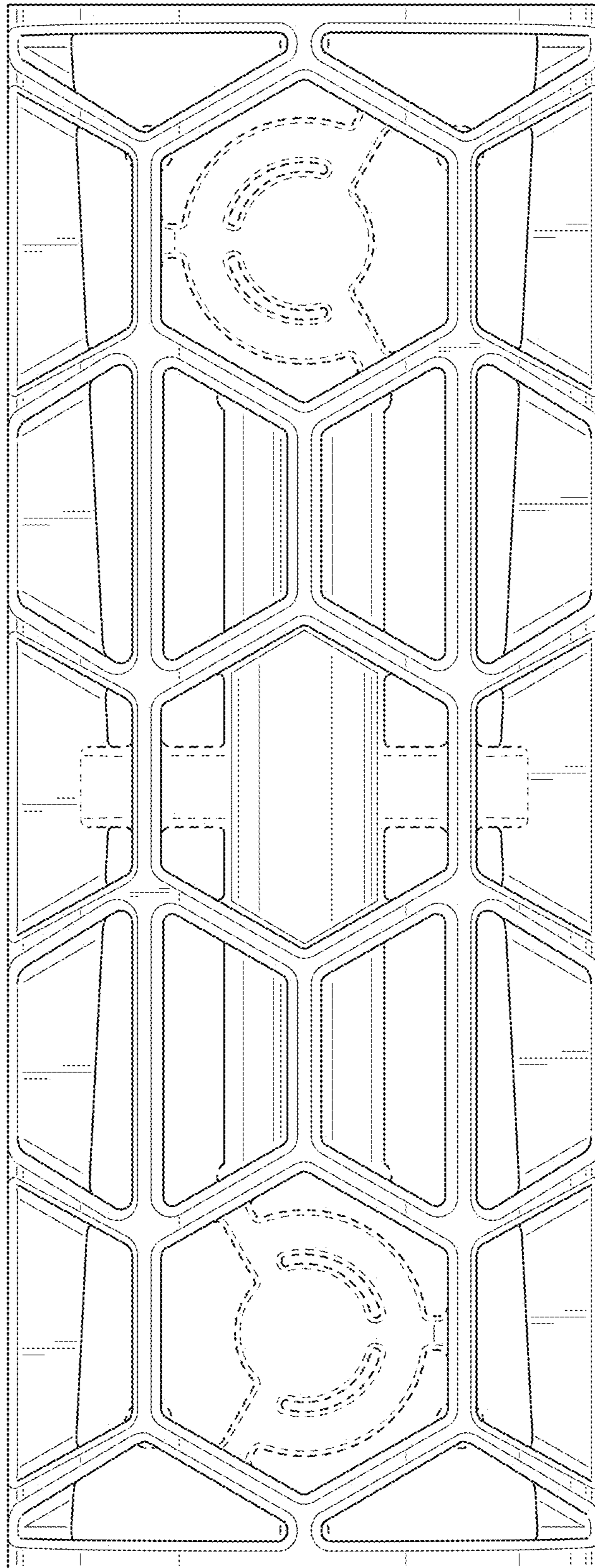

FIG. 7