



US00D908166S

(12) **United States Design Patent**
Phillip

(10) **Patent No.:** **US D908,166 S**
(45) **Date of Patent:** **** Jan. 19, 2021**

(54) **MONOCLE**

(71) Applicant: **Lisa A. Phillip**, Houston, TX (US)

(72) Inventor: **Lisa A. Phillip**, Houston, TX (US)

(**) Term: **15 Years**

(21) Appl. No.: **29/710,279**

(22) Filed: **Oct. 22, 2019**

(51) **LOC (13) Cl.** **16-06**

(52) **U.S. Cl.**
USPC **D16/302**

(58) **Field of Classification Search**
USPC D16/302, 315, 300, 301, 314
CPC G02C 7/10; G02C 2200/12; G02C 5/008
See application file for complete search history.

(56) **References Cited**

U.S. PATENT DOCUMENTS

D208,270 S * 8/1967 Boxer D16/306
D304,950 S * 12/1989 Guillet D16/305
D513,517 S * 1/2006 Wahlgren D16/300

OTHER PUBLICATIONS

Cos Monocles, posted at aliexpress.com, posting date not given, [online], [site visited Dec. 1, 2020]. Available from Internet, URL: <https://www.aliexpress.com/i/32956189106.html> (Year: 2020).*
Toho Megane Monocle, posted at otakumode.com, posting date by Sep. 9, 2016, [online], [site visited Dec. 1, 2020]. Available from Internet, URL: <https://otakumode.com/shop/554b1fc6c8decfd1129624fe/> Toho-Megane-Monocle-Sakuya-Izayoi-Model (Year: 2016).*

* cited by examiner

Primary Examiner — George D. Kirschbaum

Assistant Examiner — Maria J. Edwards

(74) *Attorney, Agent, or Firm* — Hunt Pennington Kumar & Dula pllc

(57) **CLAIM**

The ornamental design for a monocle, as shown and described.

DESCRIPTION

FIG. 1 is a front perspective view of a monocle showing my new design.
FIG. 2 is a left-side perspective view of a left side thereof.
FIG. 3 is a right-side perspective view thereof.
FIG. 4 is an elevated rear perspective view thereof.
FIG. 5 is a front view thereof.
FIG. 6 is a rear view thereof.
FIG. 7 is a left-side view thereof.
FIG. 8 is a right-side view thereof.
FIG. 9 is a top view thereof.
FIG. 10 is a bottom view thereof.
FIG. 11 is a front view thereof.
FIG. 12 is a cross-section view thereof, taken along line 12-12 in FIG. 11.
FIG. 13 is a right-side perspective view with a rear hinge folded in and front hinge unfolded, thereof; and,
FIG. 14 is a right-side perspective view with a rear hinge folded in and front hinge folded in, thereof.
The broken lines depict features of the article that form no part of the claimed design.

1 Claim, 14 Drawing Sheets

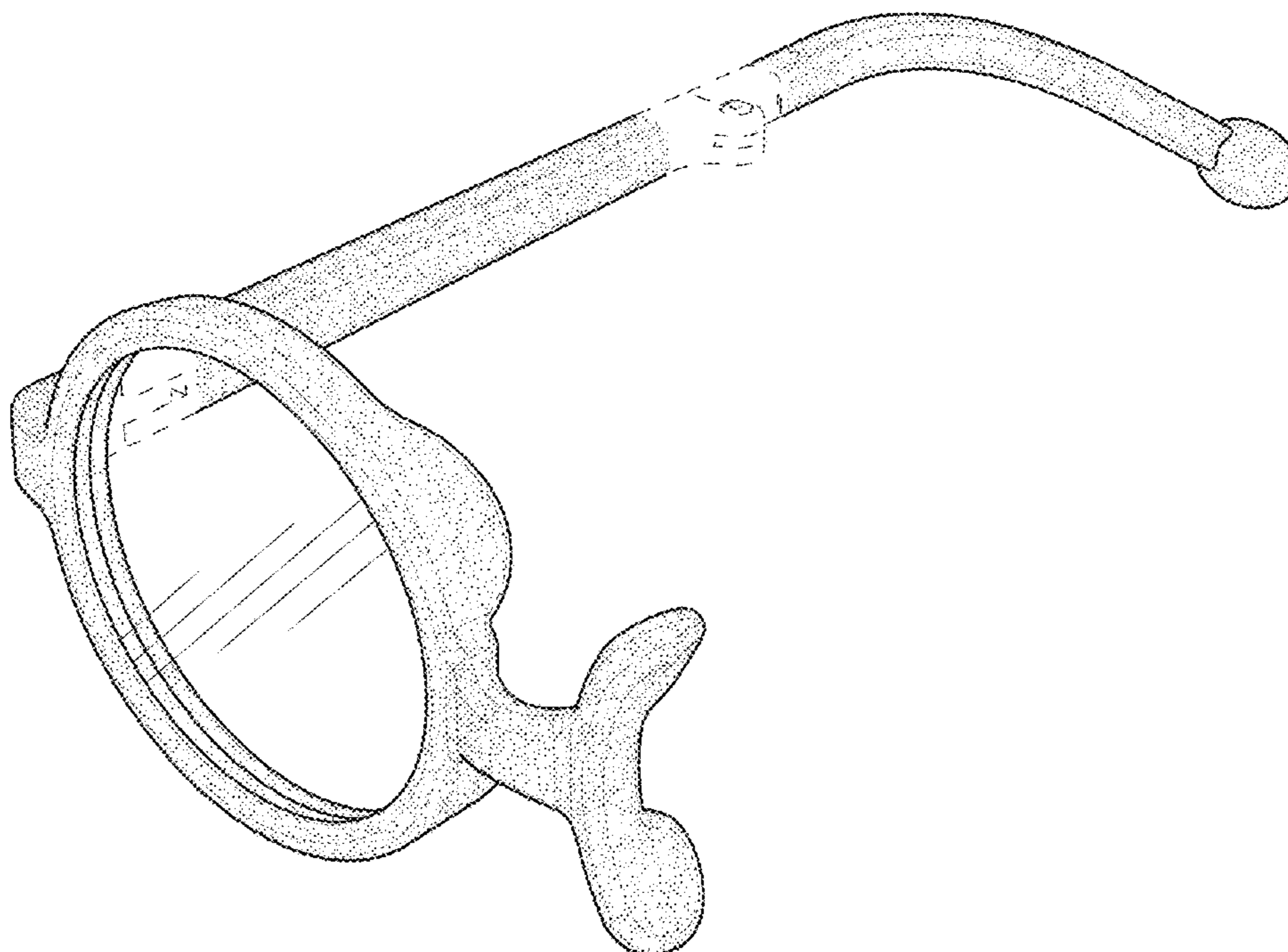

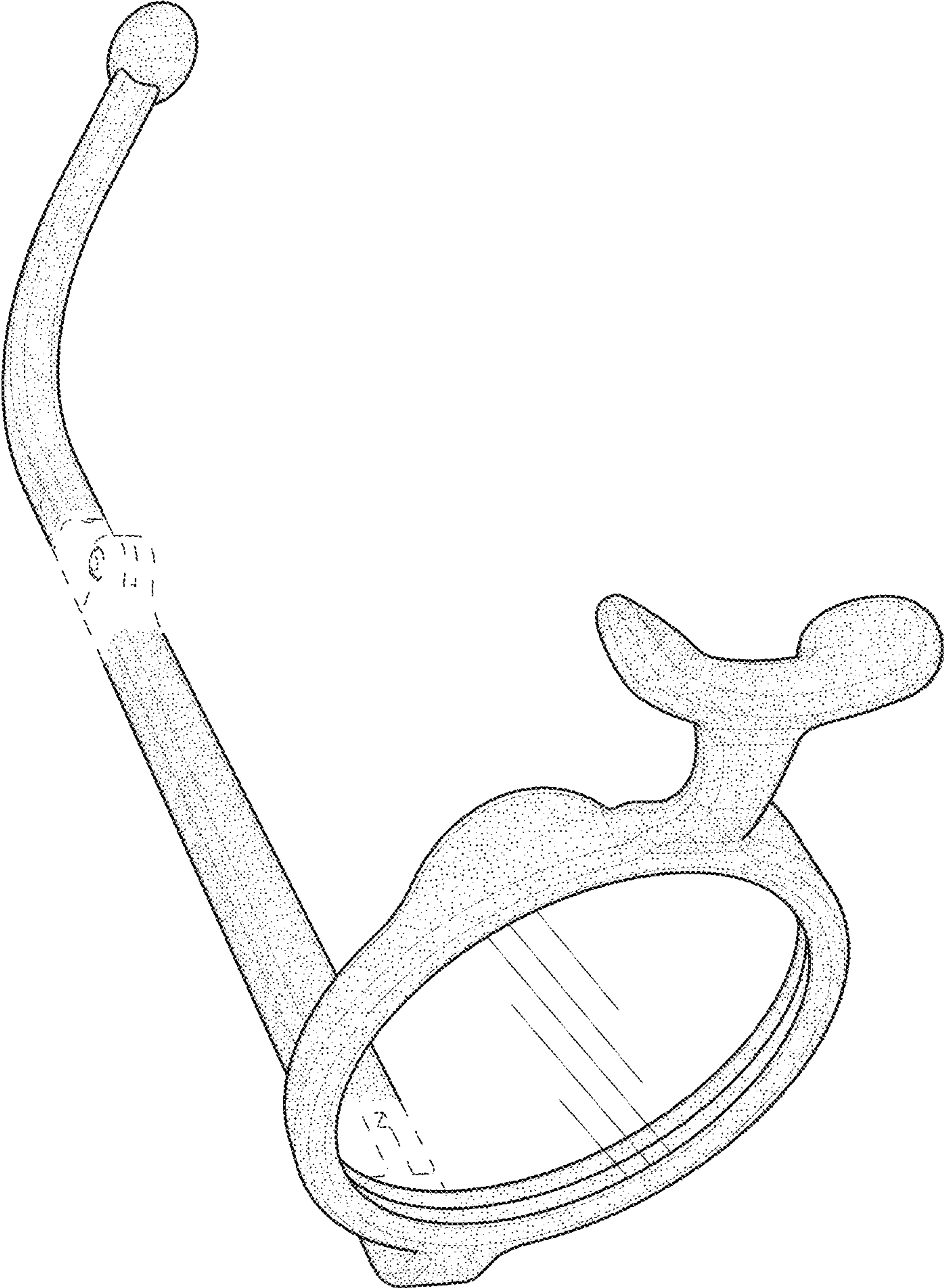

FIG.1

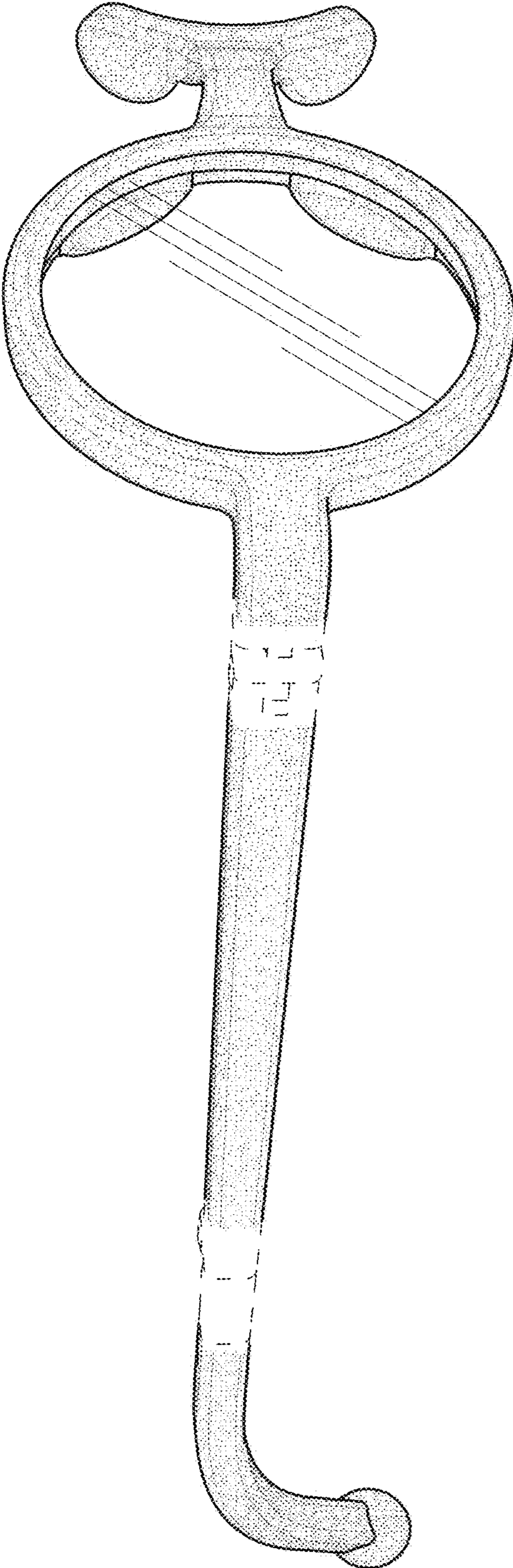

FIG.2

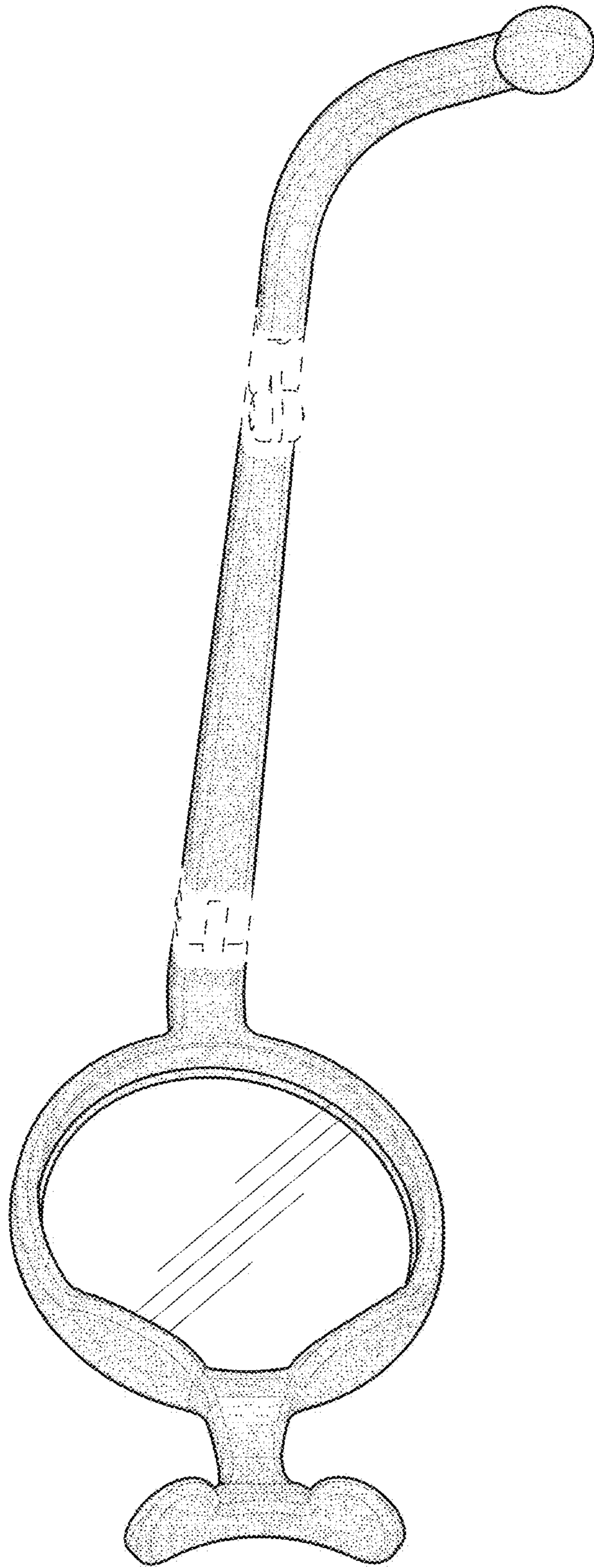

FIG.3

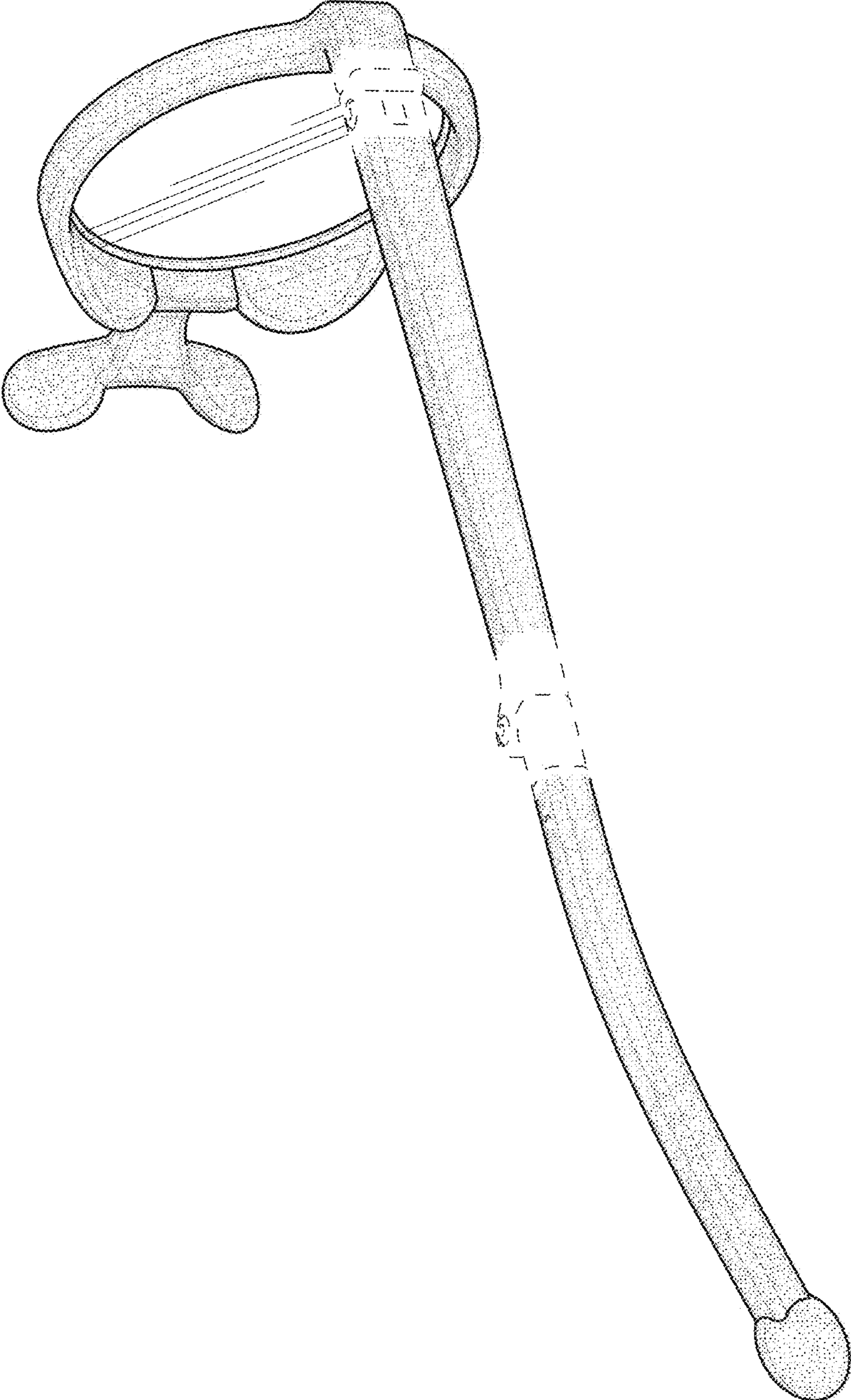

FIG. 4

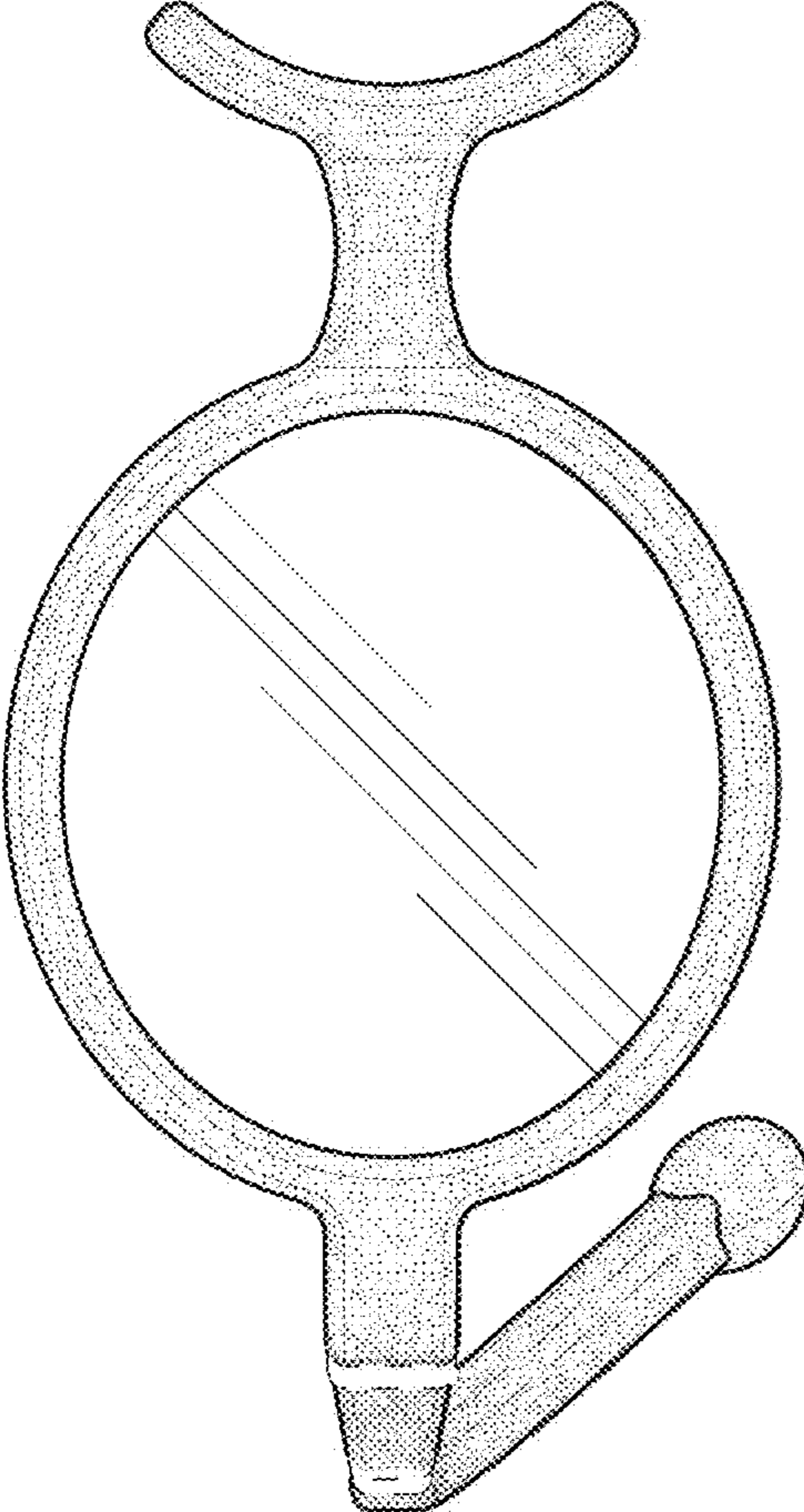

FIG.5

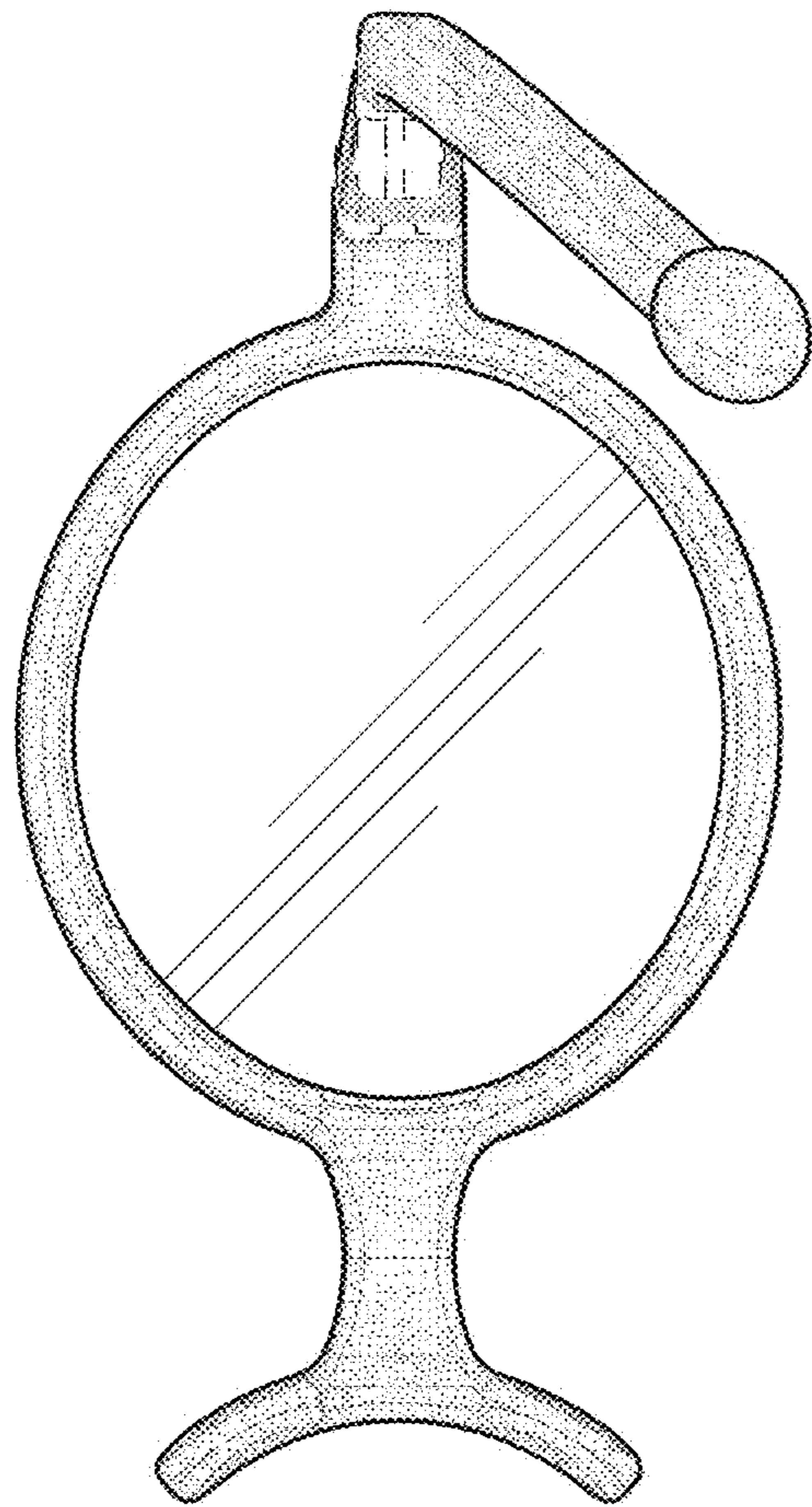

FIG.6

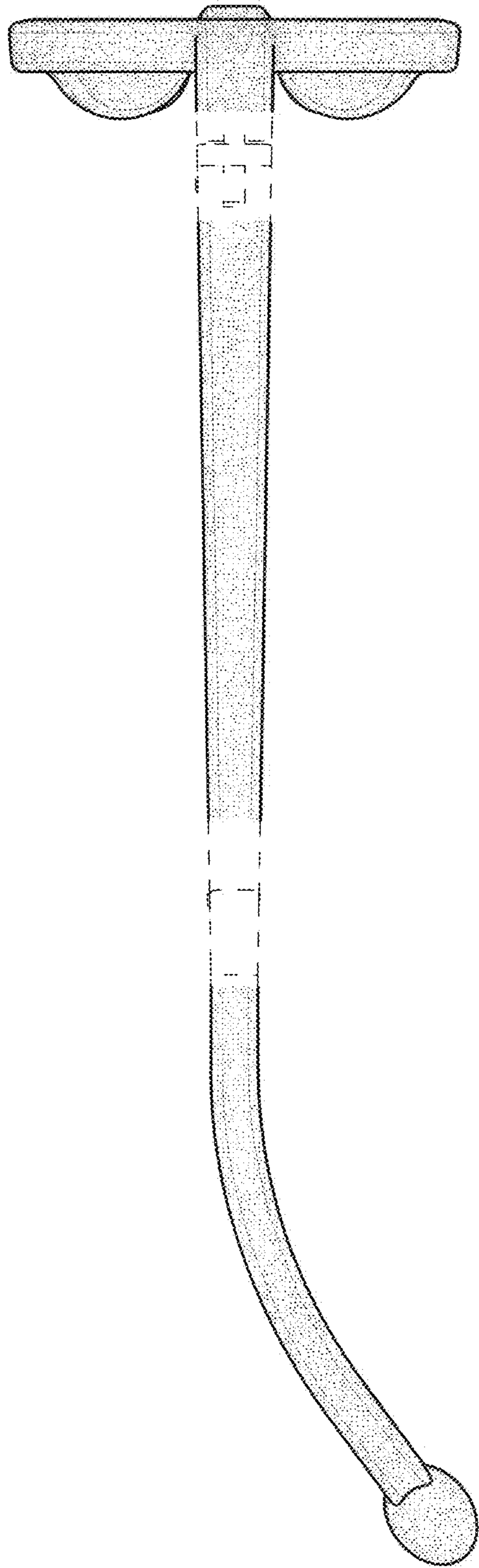

FIG.7

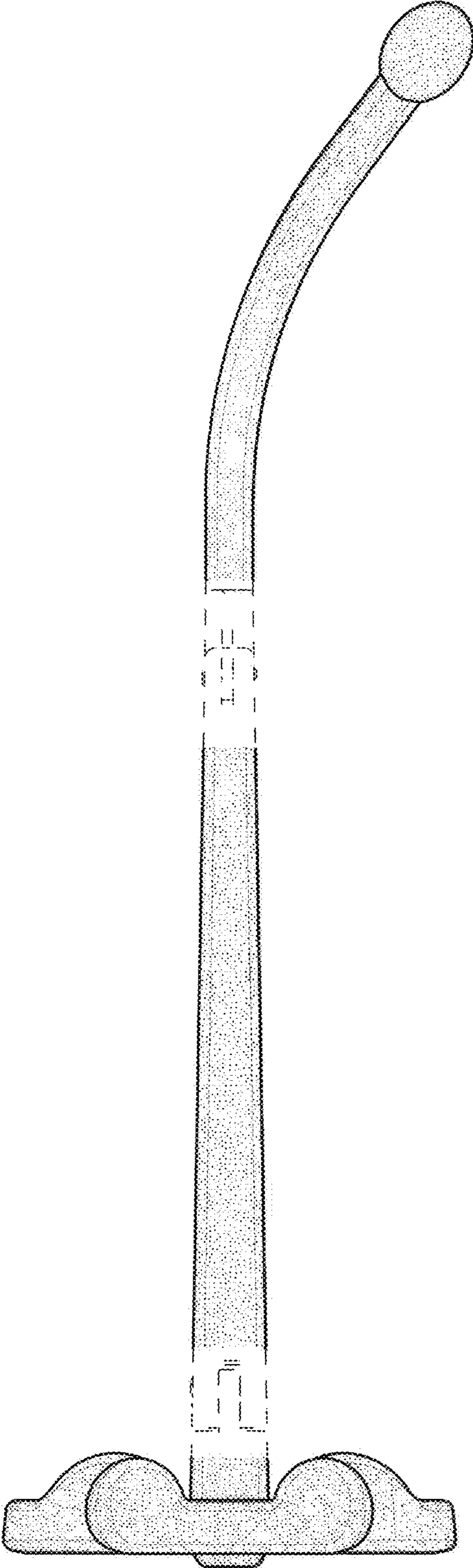

FIG.8

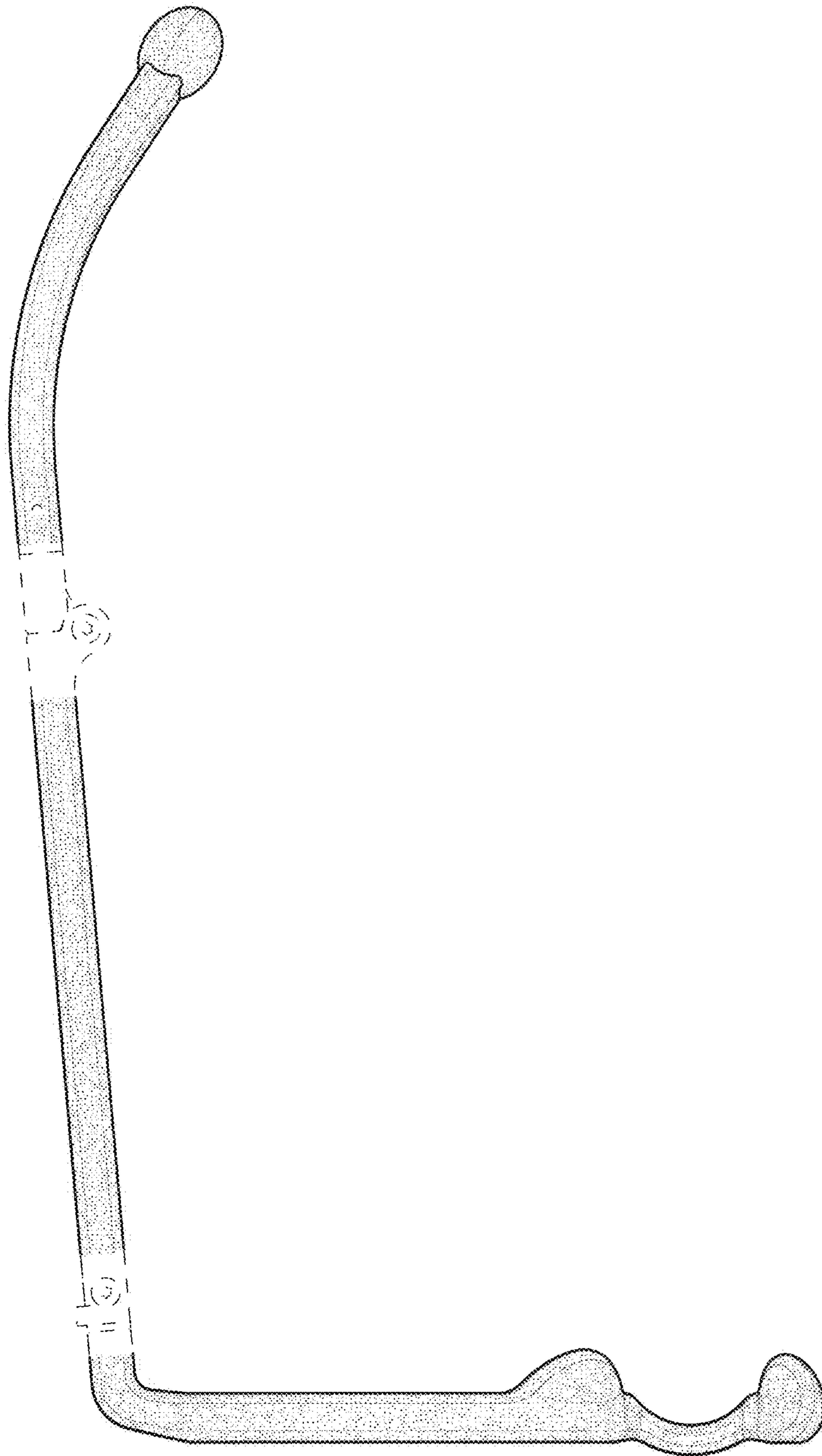

FIG. 9

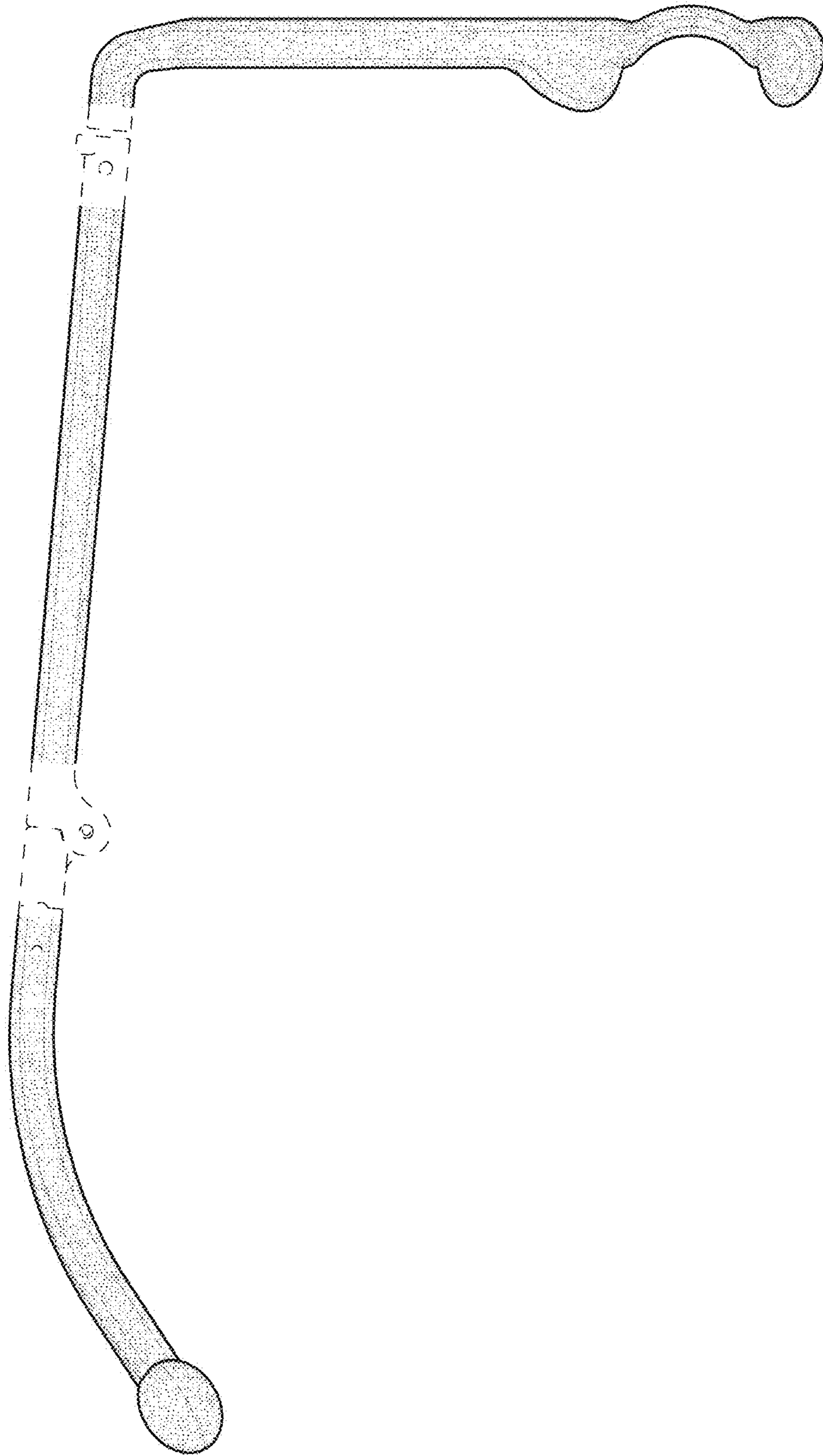

FIG.10

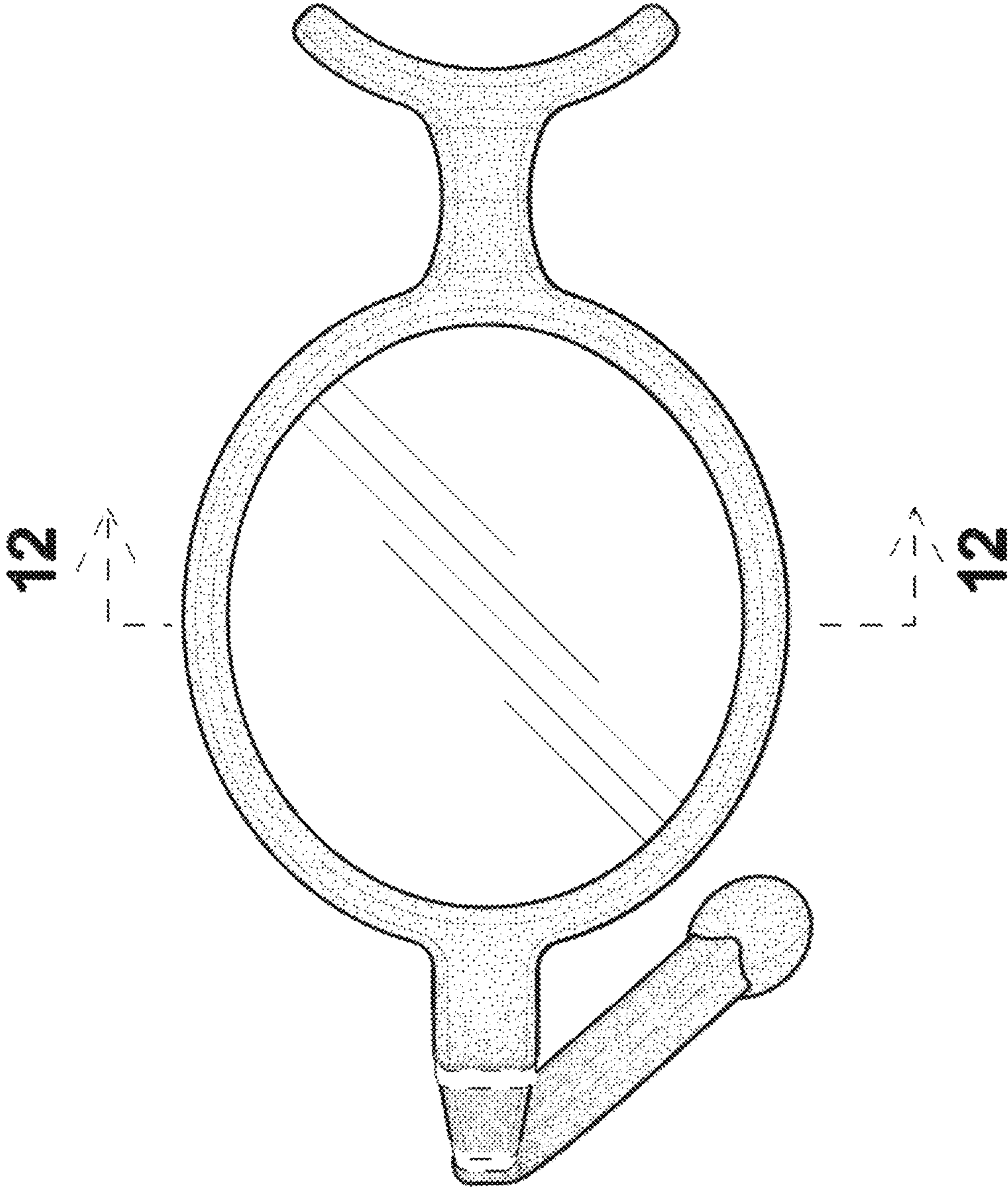

FIG.11

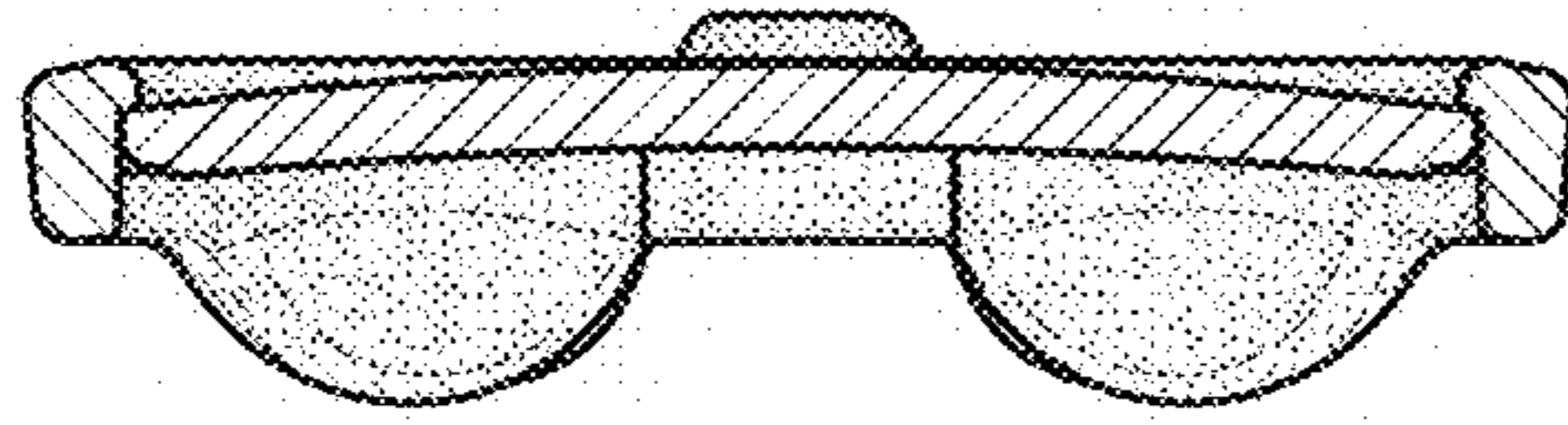

FIG.12

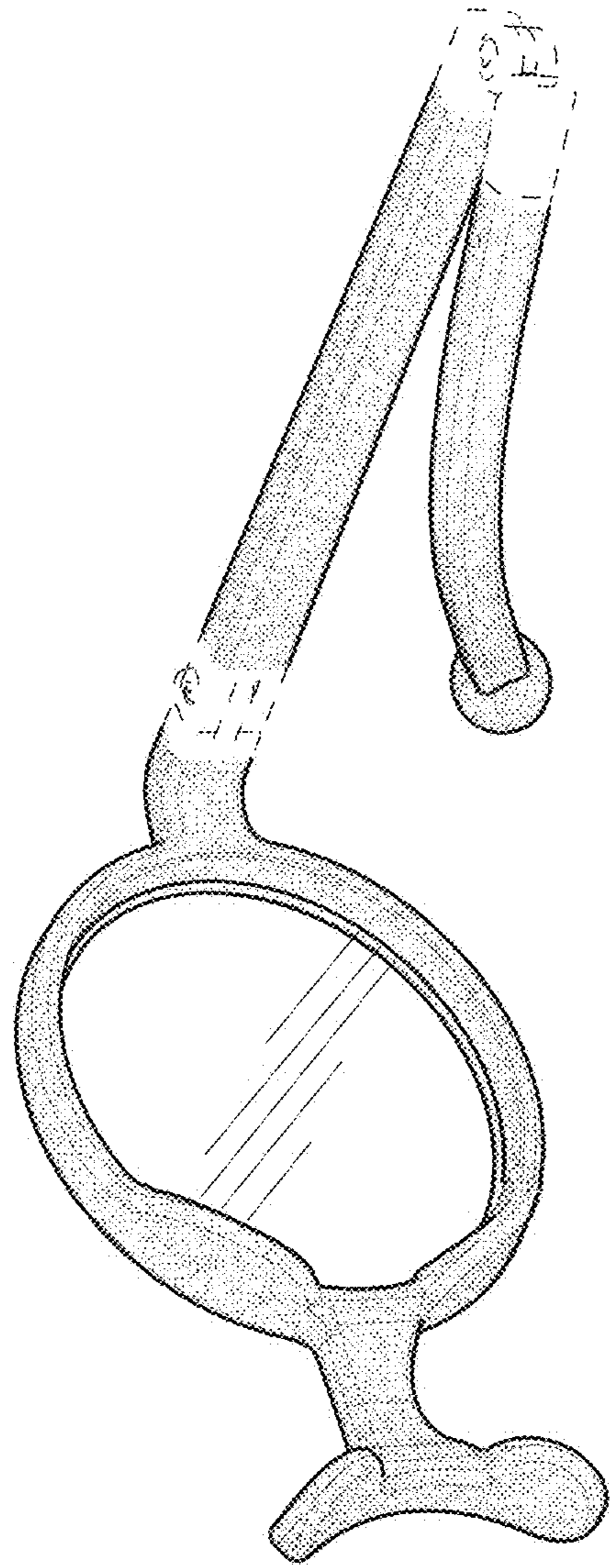

FIG.13

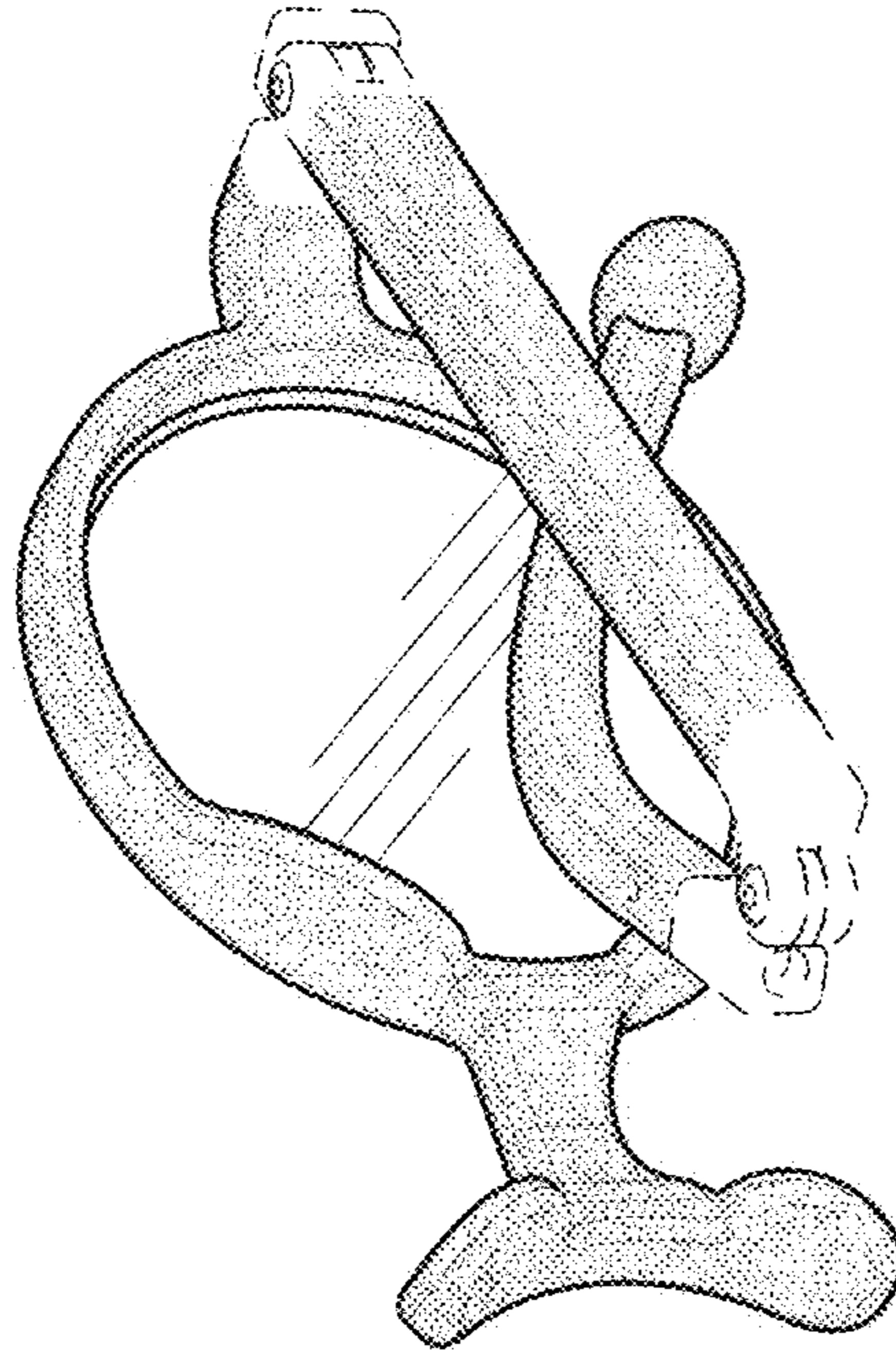

FIG.14