



US00D908154S

(12) **United States Design Patent** (10) **Patent No.:** **US D908,154 S**
Nishimura (45) **Date of Patent:** **** *Jan. 19, 2021**

(54) **BODY OF AN INDUSTRIAL CAMERA FOR MACHINE VISION**

(71) Applicant: **CANON KABUSHIKI KAISHA,**
Tokyo (JP)

(72) Inventor: **Kenichi Nishimura,** Tokyo (JP)

(*) Notice: This patent is subject to a terminal disclaimer.

(**) Term: **15 Years**

(21) Appl. No.: **35/507,391**

(22) Filed: **Mar. 1, 2019**

(80) **Hague Agreement Data**

Int. Filing Date: **Mar. 1, 2019**
Int. Reg. No.: **DM/201291**
Int. Reg. Date: **Mar. 1, 2019**
Int. Reg. Pub. Date: **Sep. 6, 2019**

(30) **Foreign Application Priority Data**

Sep. 4, 2018 (JP) 2018-019236

(51) **LOC (13) Cl.** **16-01**

(52) **U.S. Cl.**
USPC **D16/200**

(58) **Field of Classification Search**
USPC D16/200–204, 208, 218, 219
CPC G03B 15/03; G03B 17/02; G03B 17/04;
G03B 17/48; G03B 17/56
See application file for complete search history.

(56) **References Cited**

U.S. PATENT DOCUMENTS

D150,914 S * 9/1948 Wolfer et al. D16/221
D183,071 S * 6/1958 Tashima D16/221
D364,416 S * 11/1995 Saeki D16/221

D371,564 S * 7/1996 Sunada D16/221
D479,548 S * 9/2003 Bielefeld D16/200
D513,030 S * 12/2005 Schoenert D16/221
D514,611 S * 2/2006 Schoenert D16/221
D524,835 S * 7/2006 Barman D16/200
D546,864 S * 7/2007 Kim D16/221
D554,685 S * 11/2007 Ishikawa D16/221
D565,080 S * 3/2008 Ishikawa D16/221
D565,081 S * 3/2008 Ishikawa D16/221
D629,827 S * 12/2010 Morenstein D16/221
D756,435 S * 5/2016 Duncan D16/200
D820,899 S * 6/2018 Shiono D16/221
D861,055 S * 9/2019 Sekine D16/200
D868,875 S * 12/2019 Guo D16/221
D871,488 S * 12/2019 Lee D16/221

OTHER PUBLICATIONS

Copending, unpublished International Design U.S. Appl. No. 35/507,410 to Kenichi Nishimura, filed Mar. 1, 2019.

* cited by examiner

Primary Examiner — Holly E Thurman

(57) **CLAIM**

The ornamental design for a body of an industrial camera for machine vision, as shown and described.

DESCRIPTION

1. Body of an industrial camera for machine vision
1.1 is a front view of my design;
1.2 is a back view thereof;
1.3 is a top view thereof;
1.4 is a bottom view thereof;
1.5 is a left view thereof;
1.6 is a right view thereof; and
1.7 is a perspective view thereof.

The broken lines depict portions of the body of an industrial camera for machine vision which form no part of the claimed design.

1 Claim, 7 Drawing Sheets

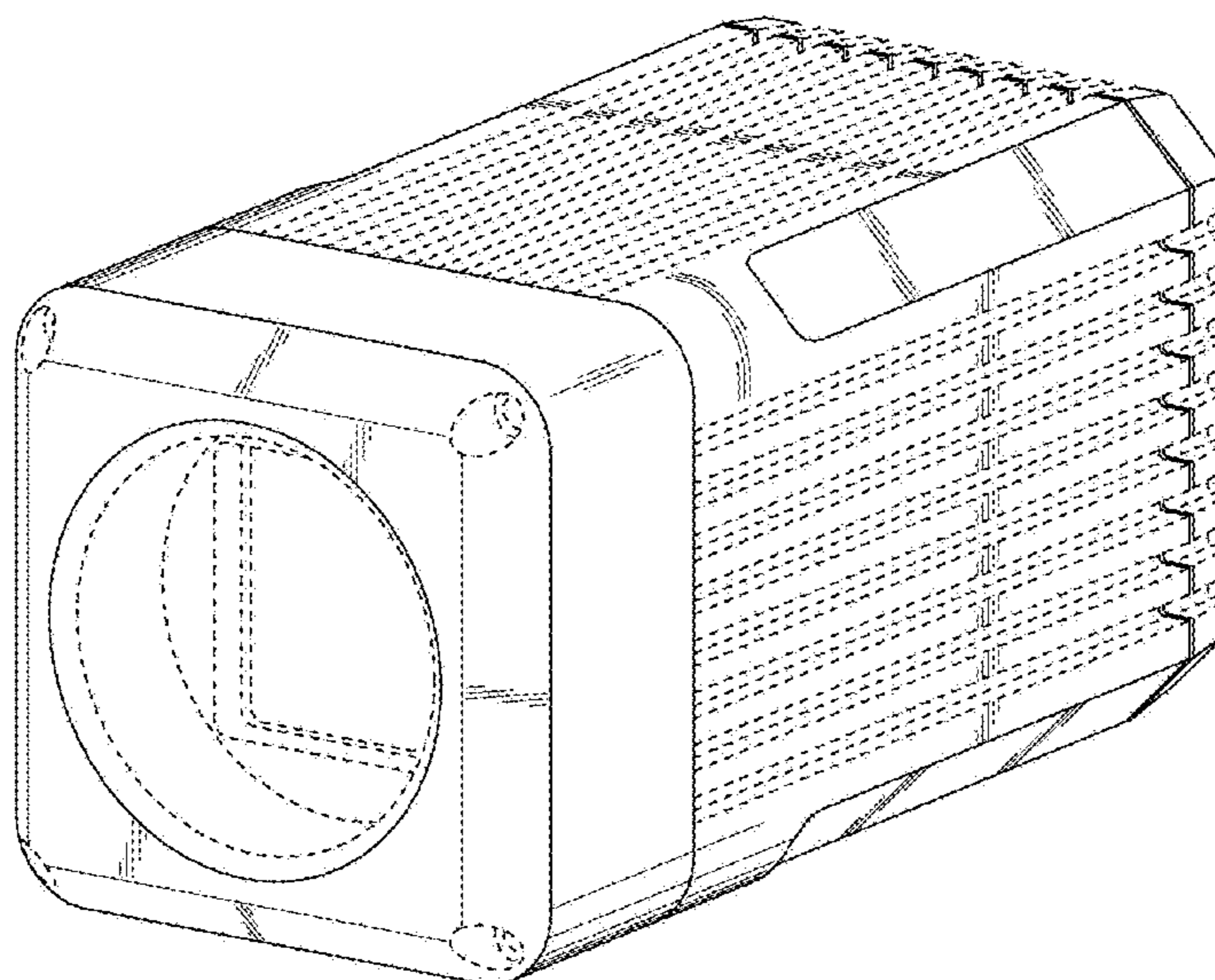

1.1

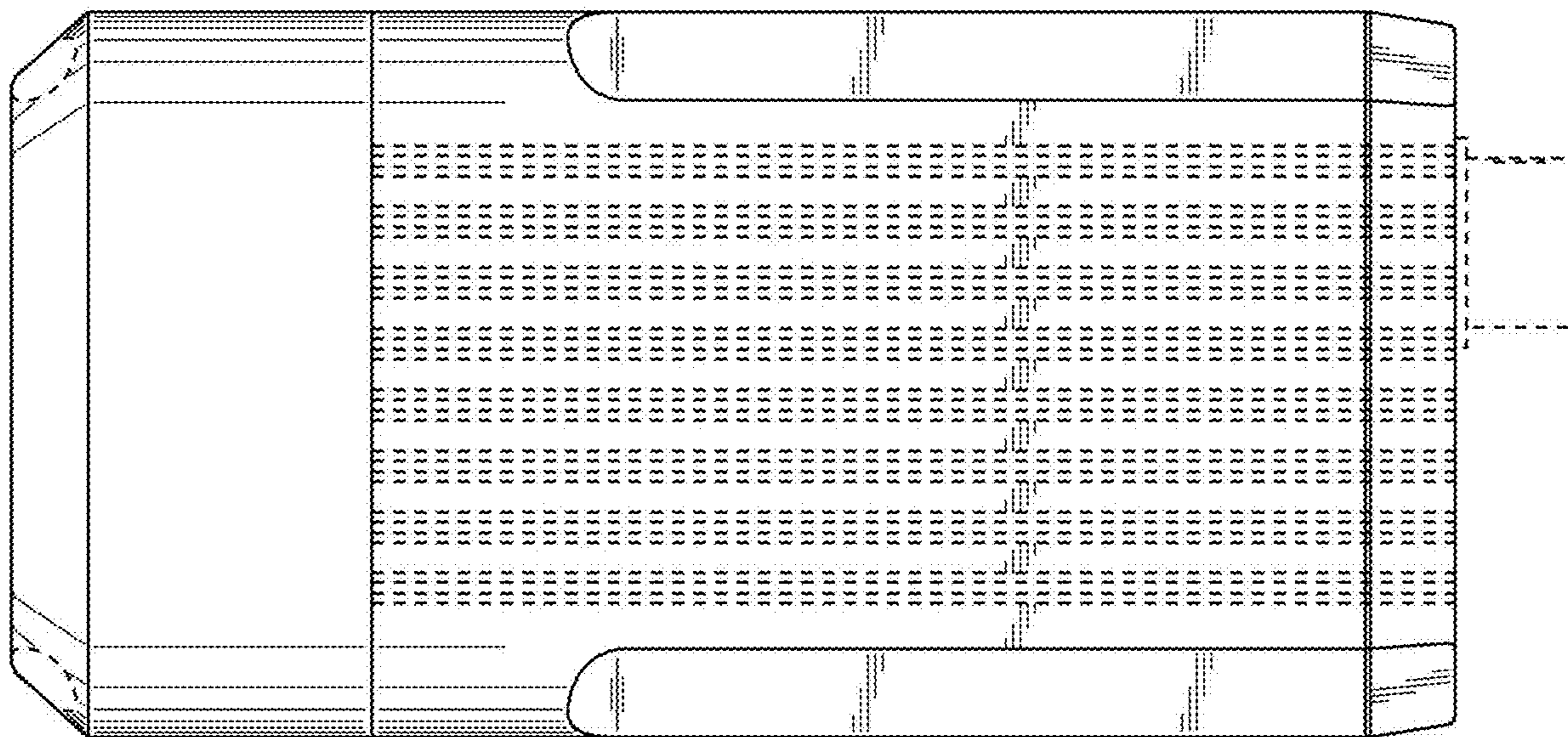

1.2

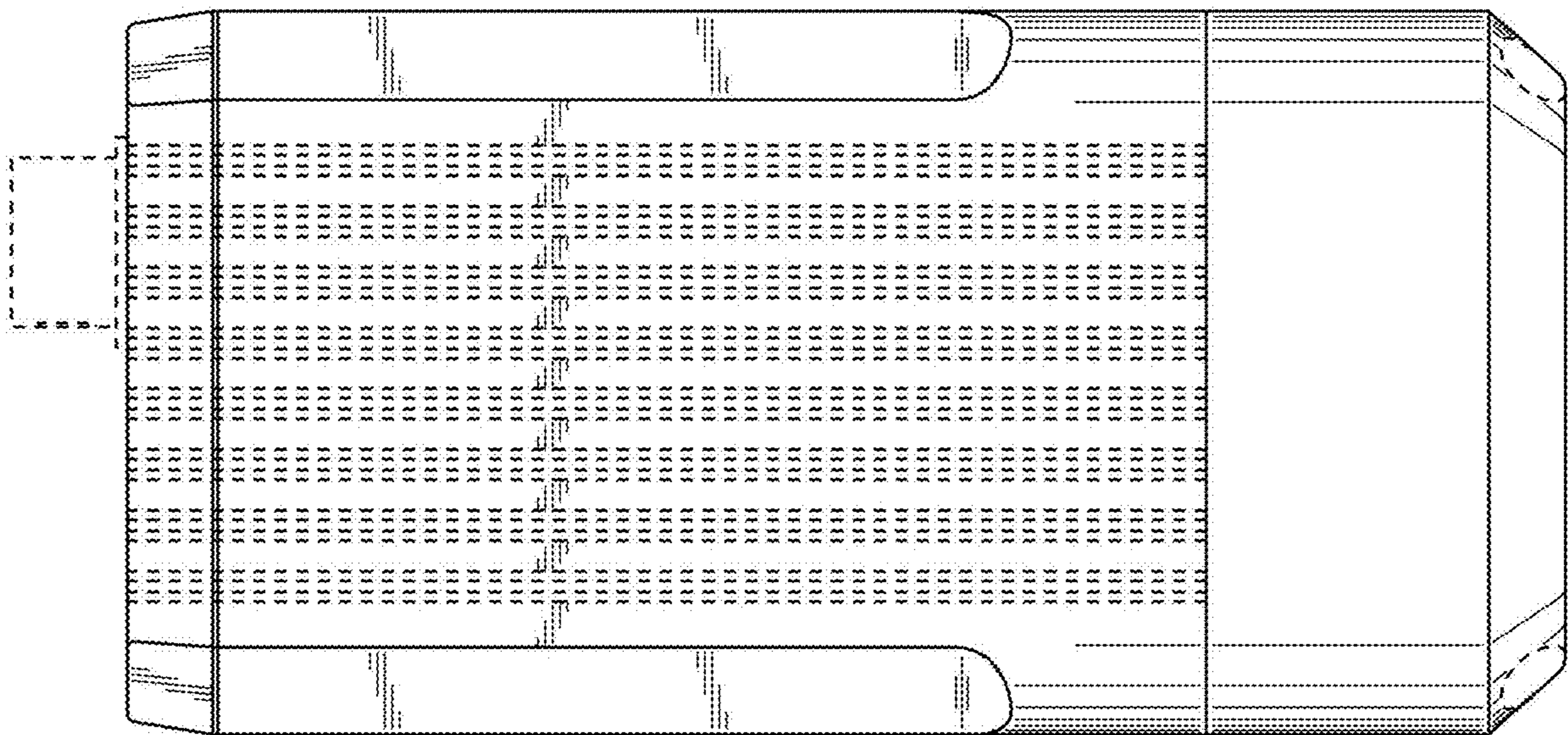

1.3

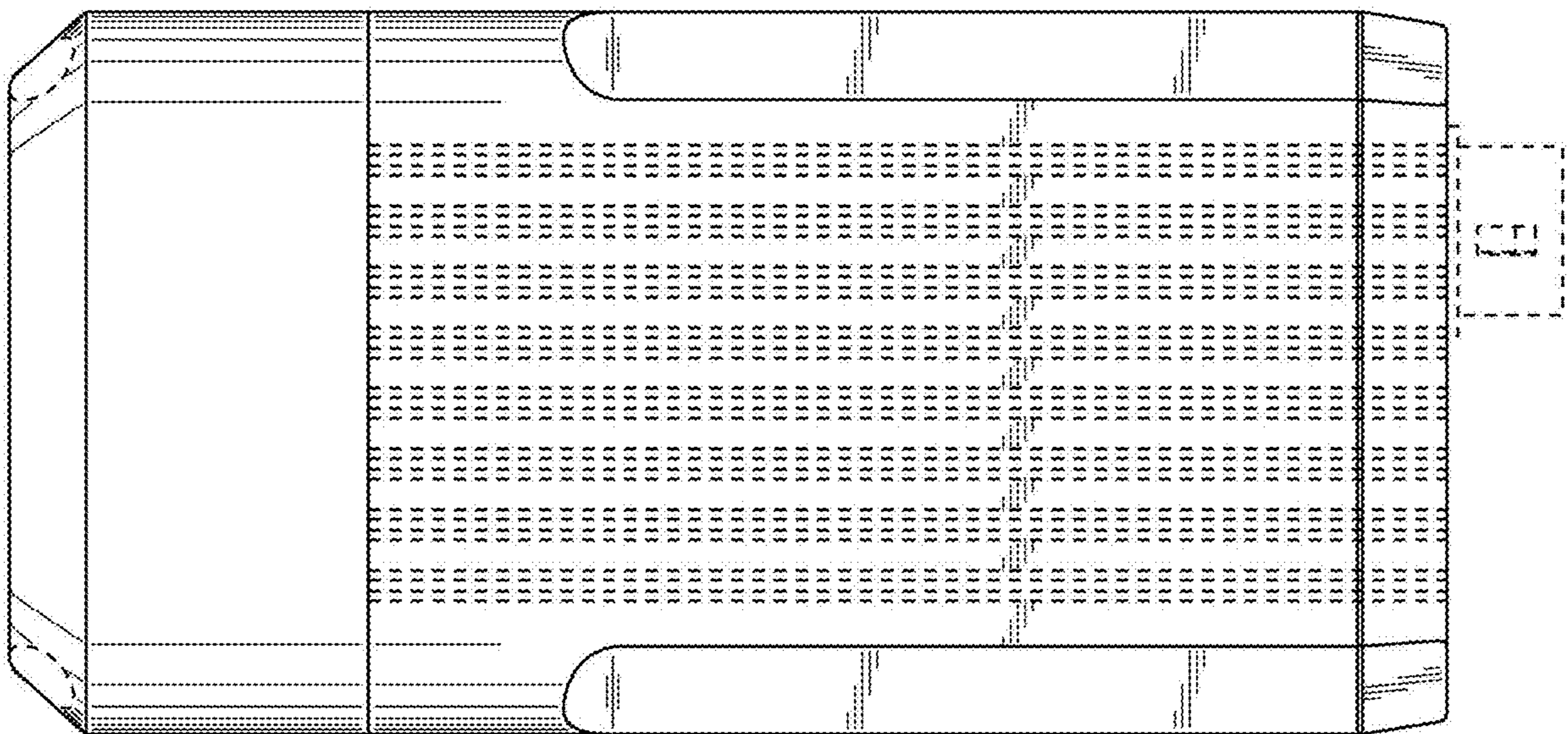

1.4

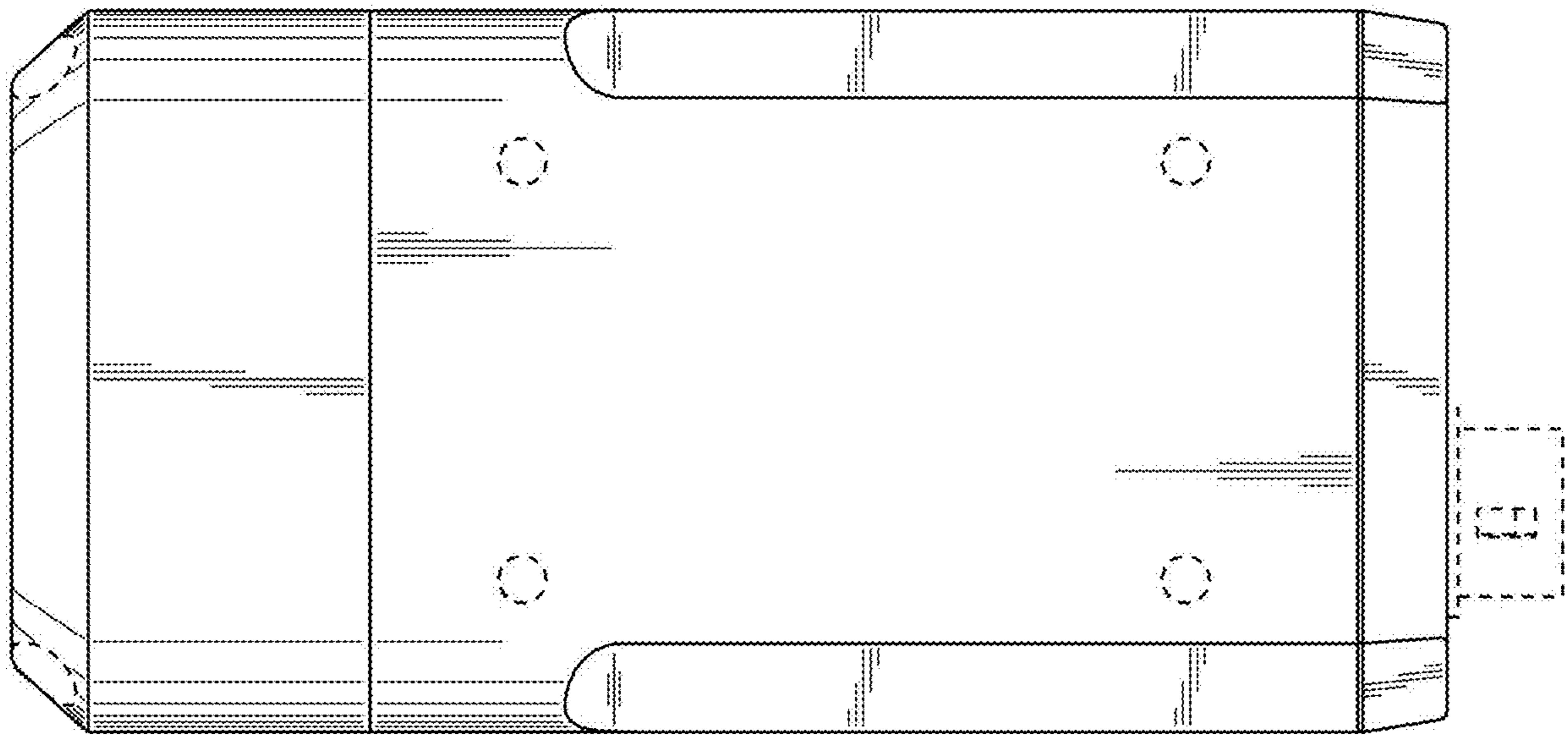

1.5

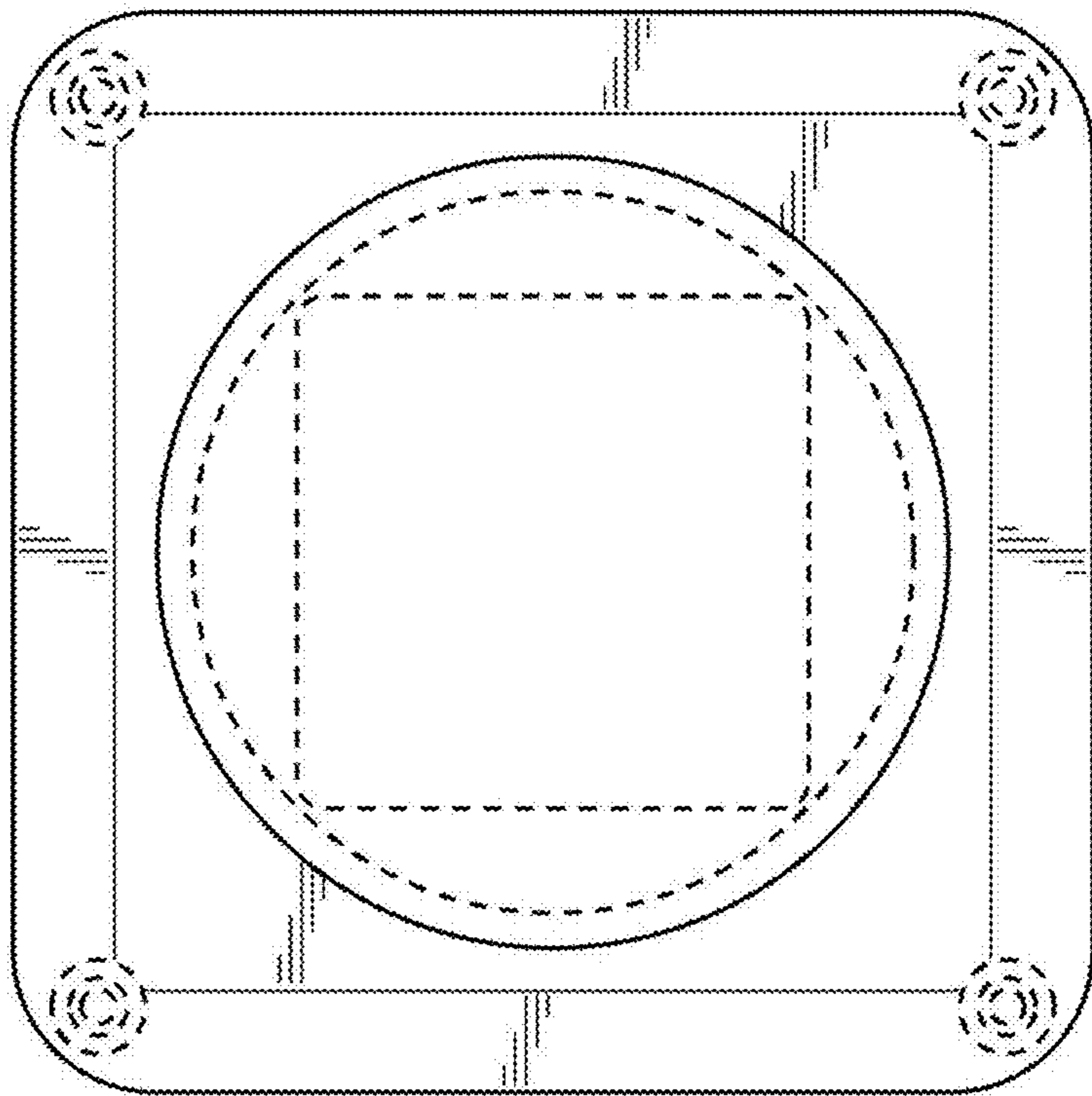

1.6

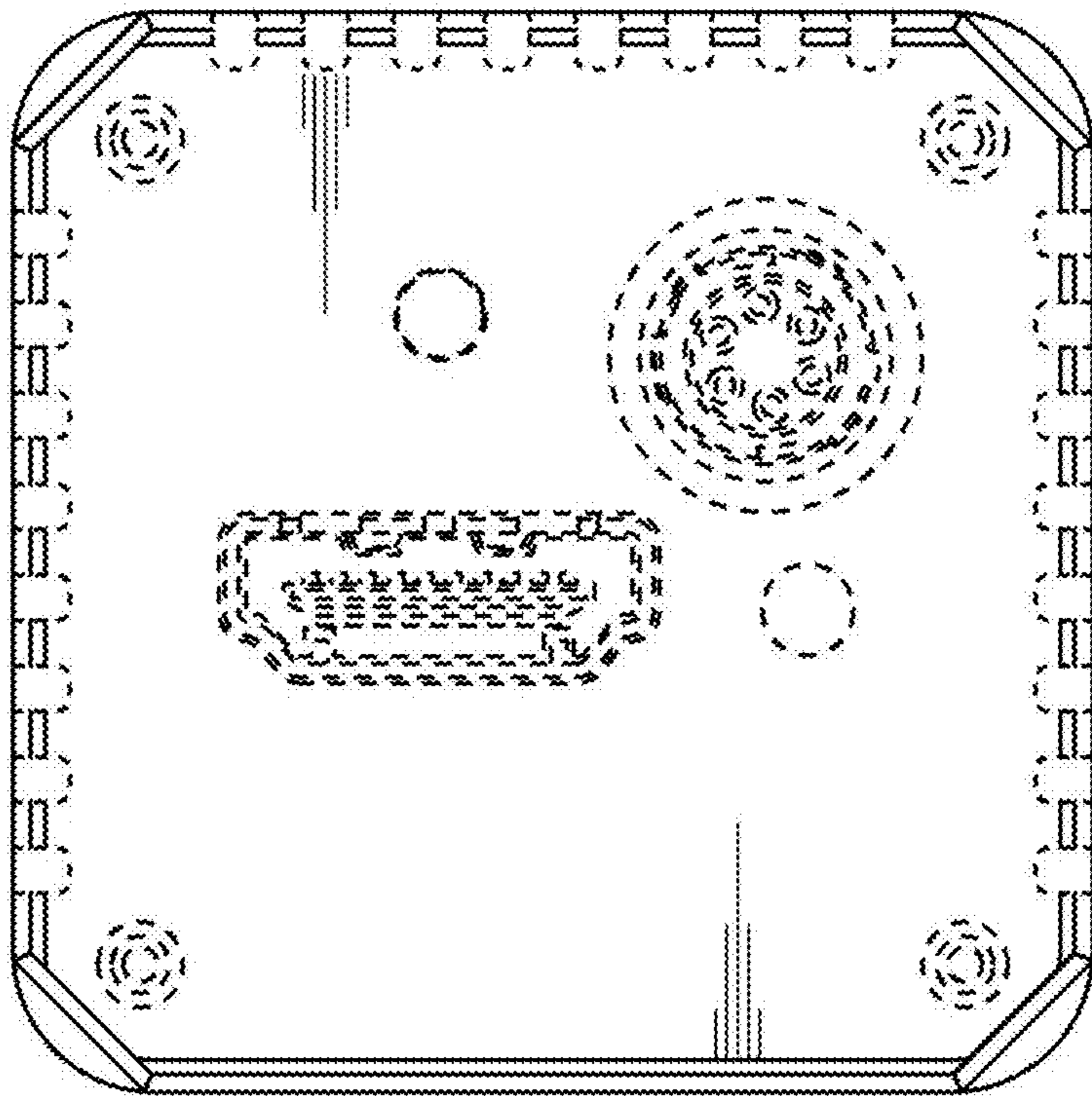

1.7

