



US00D908041S

(12) **United States Design Patent** (10) **Patent No.:** **US D908,041 S**
Brown (45) **Date of Patent:** **** Jan. 19, 2021**

(54) **GROWING TRAY**

(71) Applicant: **Paul William Brown**, Barrie (CA)
(72) Inventor: **Paul William Brown**, Barrie (CA)
(73) Assignee: **MPL INDUSTRIES LTD.**, Barrie (CA)
(**) Term: **15 Years**
(21) Appl. No.: **29/673,263**
(22) Filed: **Dec. 13, 2018**

(30) **Foreign Application Priority Data**

Jun. 13, 2018 (CA) 181914
(51) **LOC (13) Cl.** **11-02**
(52) **U.S. Cl.**
USPC **D11/156**
(58) **Field of Classification Search**
USPC D11/143-156, 164; D3/304, 313, 314;
D6/403, 404, 405, 556, 557, 558;
D25/119, 120, 121
CPC . A01G 5/04; A01G 9/02; A01G 9/021; A01G
9/022; A01G 9/026; A01G 9/027; A01G
9/029; A01G 9/033; A47G 7/00; A47G
7/02; A47G 7/04; A47G 7/041;
(Continued)

(56) **References Cited**

U.S. PATENT DOCUMENTS
2,541,421 A * 2/1951 Hunter E06B 7/18
49/305
2,718,677 A * 9/1955 Cornell E06B 7/2316
49/469
(Continued)

FOREIGN PATENT DOCUMENTS

AU 2015243012 4/2017
CA 2 908 184 4/2017
EP 3 155 896 4/2017

OTHER PUBLICATIONS

U.S. Appl. No. 29/673,265, filed Dec. 13, 2018, Brown.
Primary Examiner — Elizabeth A. Albert
(74) *Attorney, Agent, or Firm* — Daniel F. Nesbitt; Hasse
& Nesbitt LLC

(57) **CLAIM**

I claim the ornamental design for a growing tray, as shown and described.

DESCRIPTION

FIG. 1 is a top-front perspective view of a growing tray, showing the new design;
FIG. 2 is a bottom-rear perspective view thereof;
FIG. 3 is a left side view thereof;
FIG. 4 is a front view thereof;
FIG. 5 is a right side view thereof;
FIG. 6 is a rear view thereof;
FIG. 7 is a top plan view thereof; and
FIG. 8 is a bottom plan view thereof.
FIG. 9 is a top-front perspective view of a second embodiment of a growing tray, showing the new design;
FIG. 10 is a bottom-rear perspective view thereof;
FIG. 11 is a left side view thereof;
FIG. 12 is a front view thereof;
FIG. 13 is a right side view thereof;
FIG. 14 is a rear view thereof;
FIG. 15 is a top plan view thereof; and,
FIG. 16 is a bottom plan view thereof.
The dashed broken lines in FIGS. 1-6 and 9-14 illustrate portions of the growing tray that form no part of the claimed design. The broken away symbols that consist of solid, straight zig-zag lines in FIGS. 1, 2, 3, 5, 7, 8, 9, 10, 11, 13, 15 and 16 indicate that the appearance of any portion of the article between the broken away symbols forms no part of the claimed design.

1 Claim, 10 Drawing Sheets

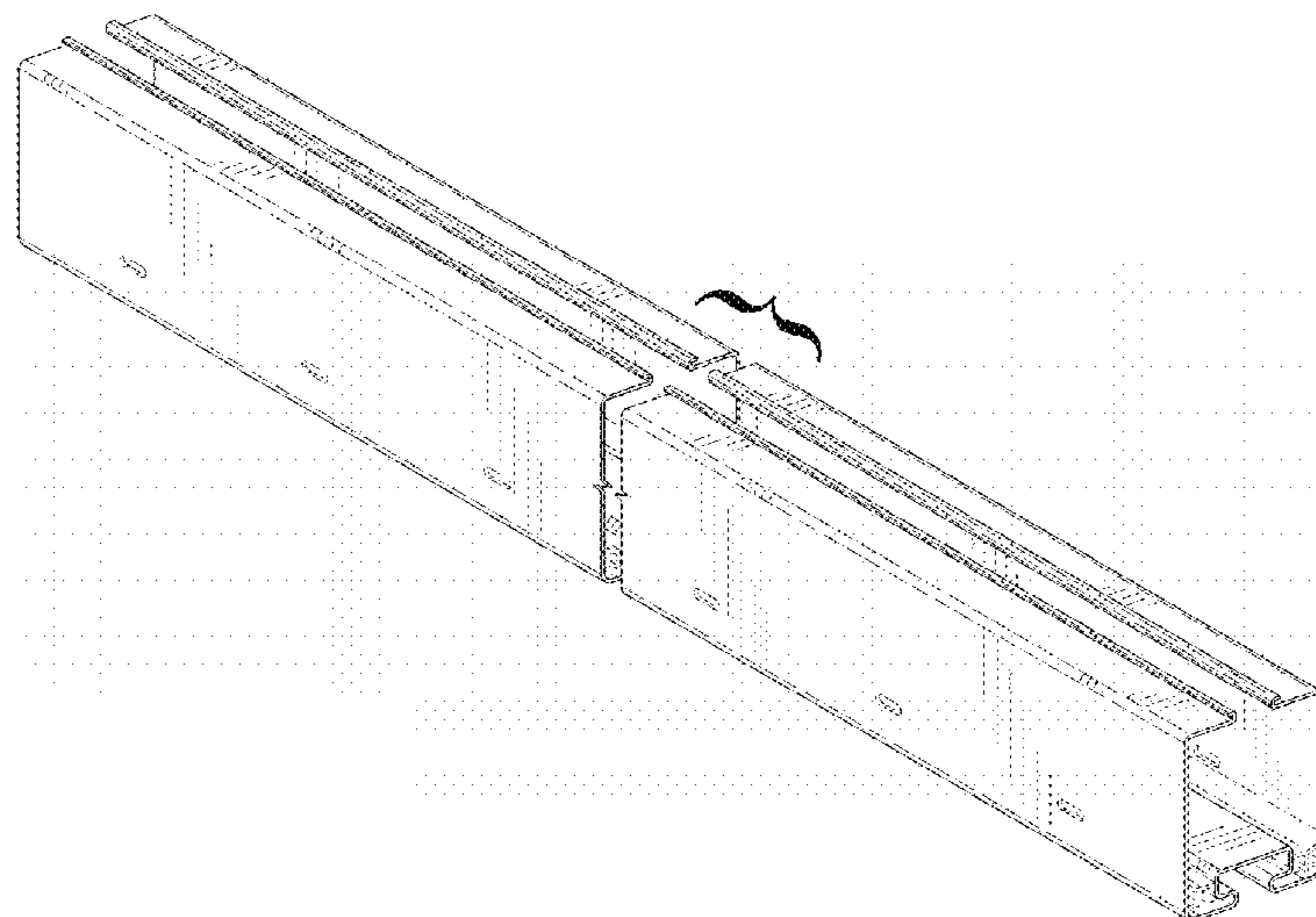

US D908,041 S

(58) **Field of Classification Search**
 CPC A47G 7/044; A47G 7/047; A47G 7/06;
 A47G 7/063; A47G 7/08
 See application file for complete search history.

(56) **References Cited**

U.S. PATENT DOCUMENTS

2,794,219 A * 6/1957 MacKlanburg E06B 7/2316
 49/469
 2,947,043 A 8/1960 Klemma
 3,003,203 A * 10/1961 Grunwald E06B 1/70
 49/467
 3,014,253 A 12/1961 Manville
 3,072,976 A 1/1963 Klaas
 3,261,130 A * 7/1966 Lawson E06B 3/9632
 49/469
 3,374,579 A * 3/1968 Neff E06B 7/2316
 49/468
 3,667,192 A * 6/1972 Sewell E06B 1/70
 52/213
 4,074,464 A * 2/1978 McCay E06B 1/70
 49/468
 4,104,830 A * 8/1978 Eagle E06B 1/70
 49/468
 4,387,535 A * 6/1983 Corbo E06B 1/70
 49/468
 D315,542 S 3/1991 Dalton et al.
 5,010,686 A * 4/1991 Rivest A01G 31/02
 47/62 C
 D318,177 S * 7/1991 Winter D25/119
 5,029,911 A * 7/1991 Daniels E05B 63/0052
 292/170
 D329,707 S * 9/1992 Embree D25/119
 D366,119 S * 1/1996 Headrick D25/48.2
 5,819,826 A * 10/1998 Schmatjen B27L 11/005
 144/241
 D430,811 S * 9/2000 DeVos D10/71

D506,663 S * 6/2005 Biller D25/125
 6,968,879 B2 * 11/2005 Schuh B27L 11/005
 144/174
 7,000,351 B2 * 2/2006 Baumann A01G 27/04
 47/32.7
 7,181,886 B2 2/2007 Bourgoin et al.
 7,559,173 B2 7/2009 Brusatore
 D674,889 S * 1/2013 Mims D23/386
 8,769,875 B1 * 7/2014 Scoggins E06B 1/70
 49/467
 8,984,807 B2 * 3/2015 Hansen A01G 31/02
 47/60
 D742,540 S * 11/2015 Singh D25/119
 D746,669 S * 1/2016 McBride E04B 1/40
 D25/121
 9,380,751 B2 * 7/2016 Storey A01G 31/02
 D785,497 S * 5/2017 Storey 47/62 N
 9,795,089 B2 * 10/2017 Kantola A01G 31/00
 9,816,311 B2 * 11/2017 Reyes E06B 1/70
 D821,915 S * 7/2018 Storey D11/155
 D826,769 S * 8/2018 Storey D11/155
 10,080,335 B1 * 9/2018 Van Wingerden A01G 31/02
 D832,738 S * 11/2018 Storey D11/143
 D834,728 S * 11/2018 Jackson D25/119
 D839,783 S * 2/2019 Van Wingerden A01G 9/047
 D11/156
 10,485,186 B2 * 11/2019 Storey A01G 31/02
 10,638,677 B2 * 5/2020 Storey A01G 31/02
 2005/0011119 A1 1/2005 Bourgoin et al.
 2009/0145870 A1 6/2009 Tagawa et al.
 2009/0165373 A1 7/2009 Souvlos et al.
 2012/0324787 A1 * 12/2012 Daas A01G 9/047
 47/65.8
 2014/0165458 A1 6/2014 Wang et al.
 2015/0208592 A1 7/2015 Marchildon
 2015/0342127 A1 * 12/2015 Gallant A01G 9/047
 47/20.1
 2017/0099792 A1 4/2017 Gallant

* cited by examiner

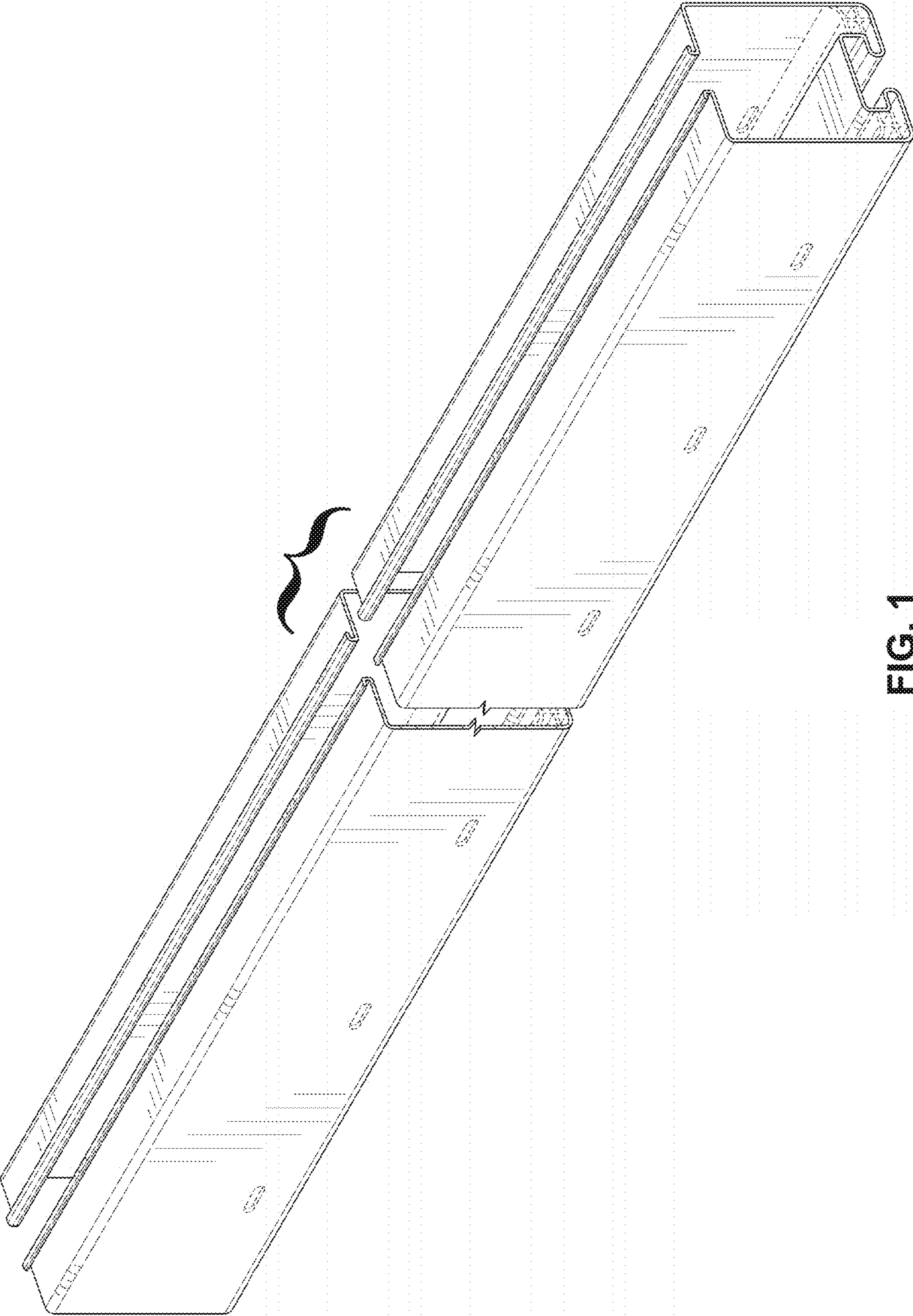

FIG. 1

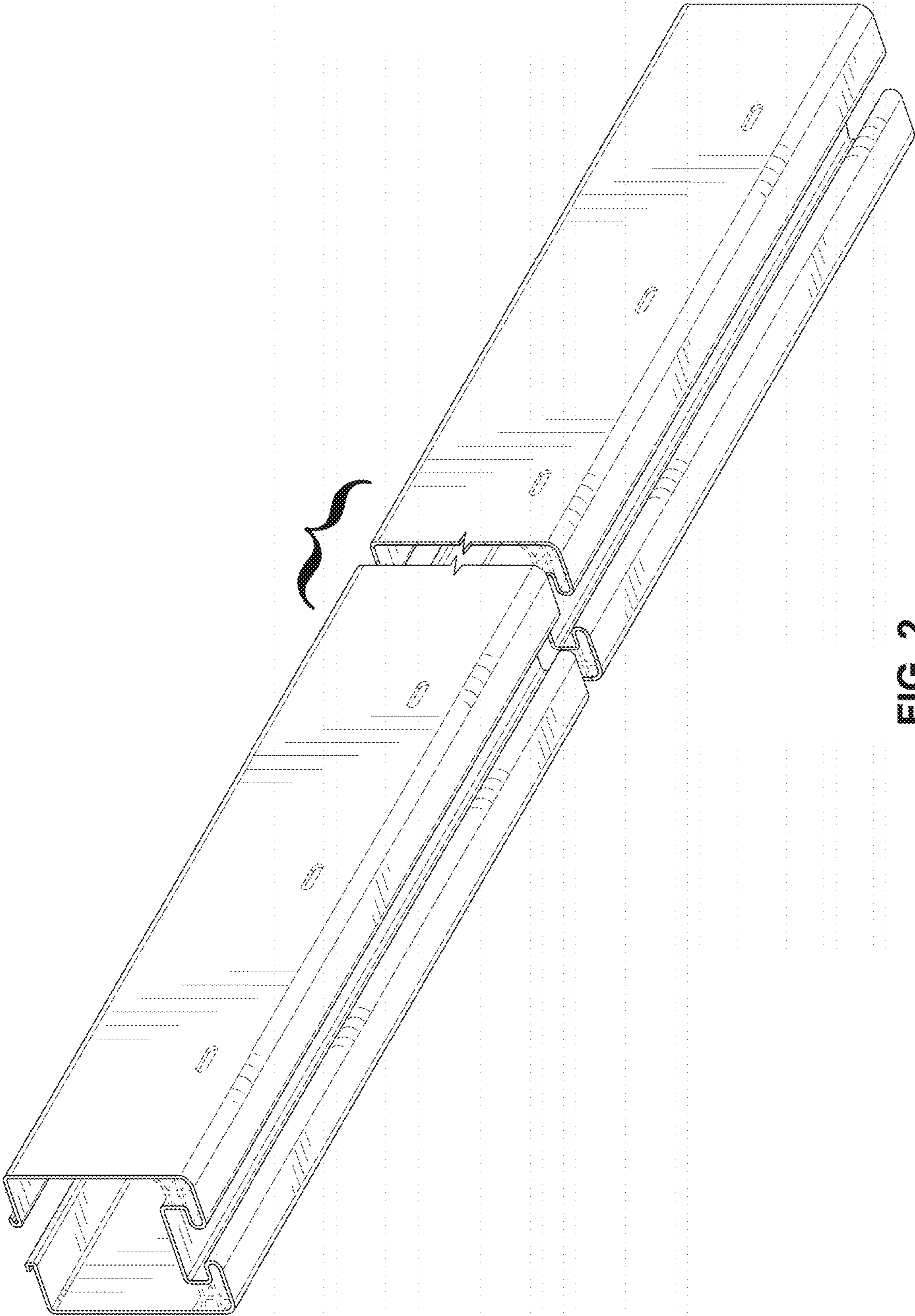

FIG. 2

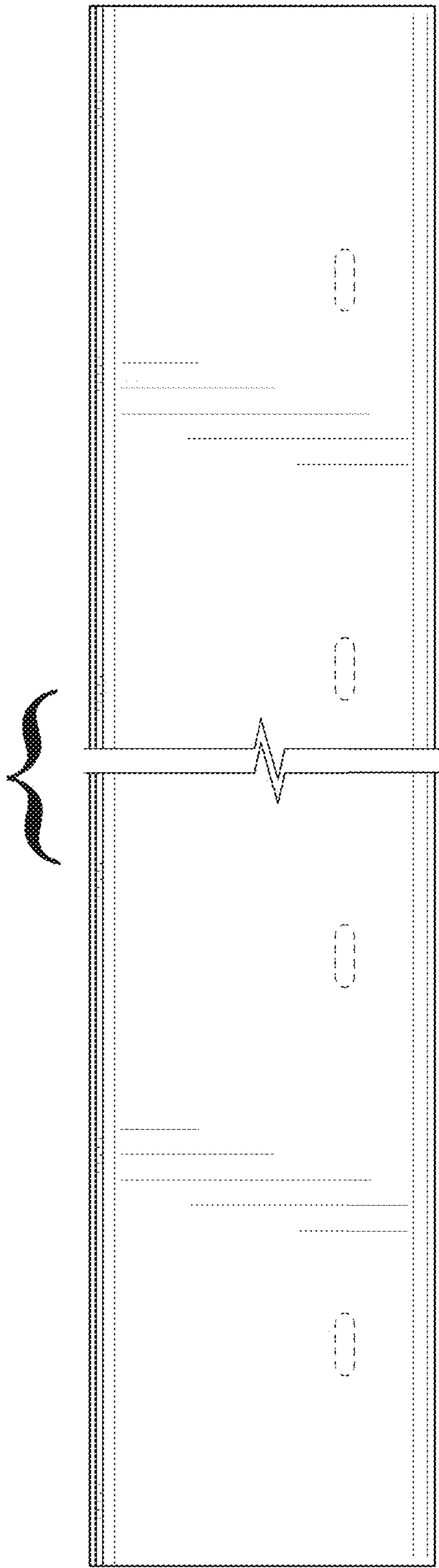

FIG. 3

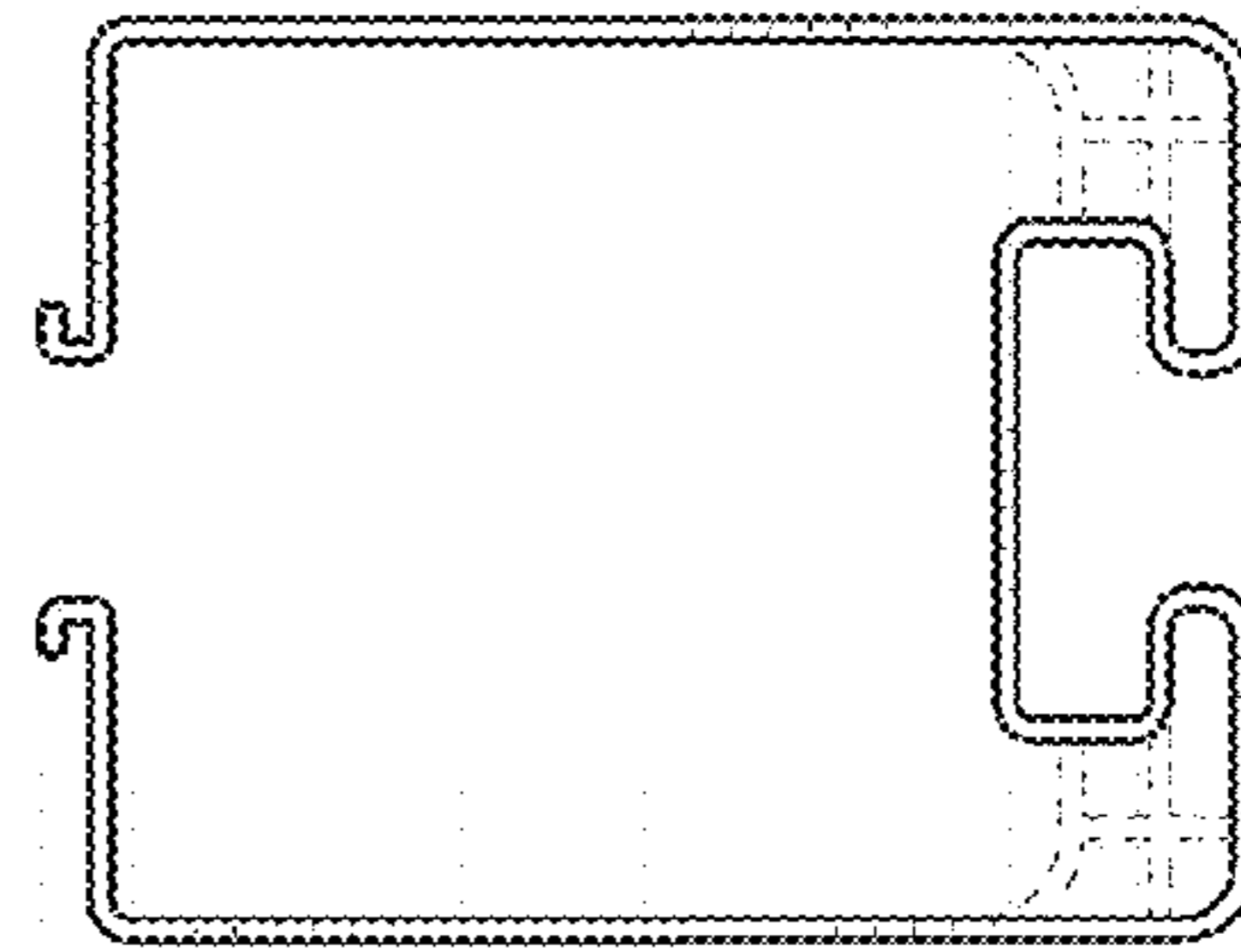

FIG. 4

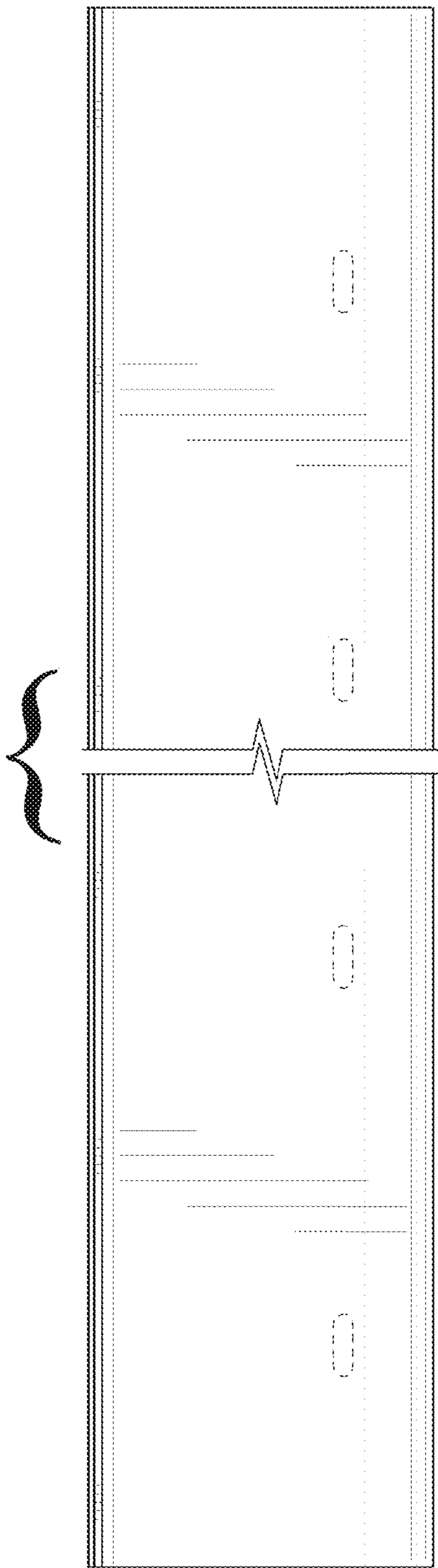

FIG. 5

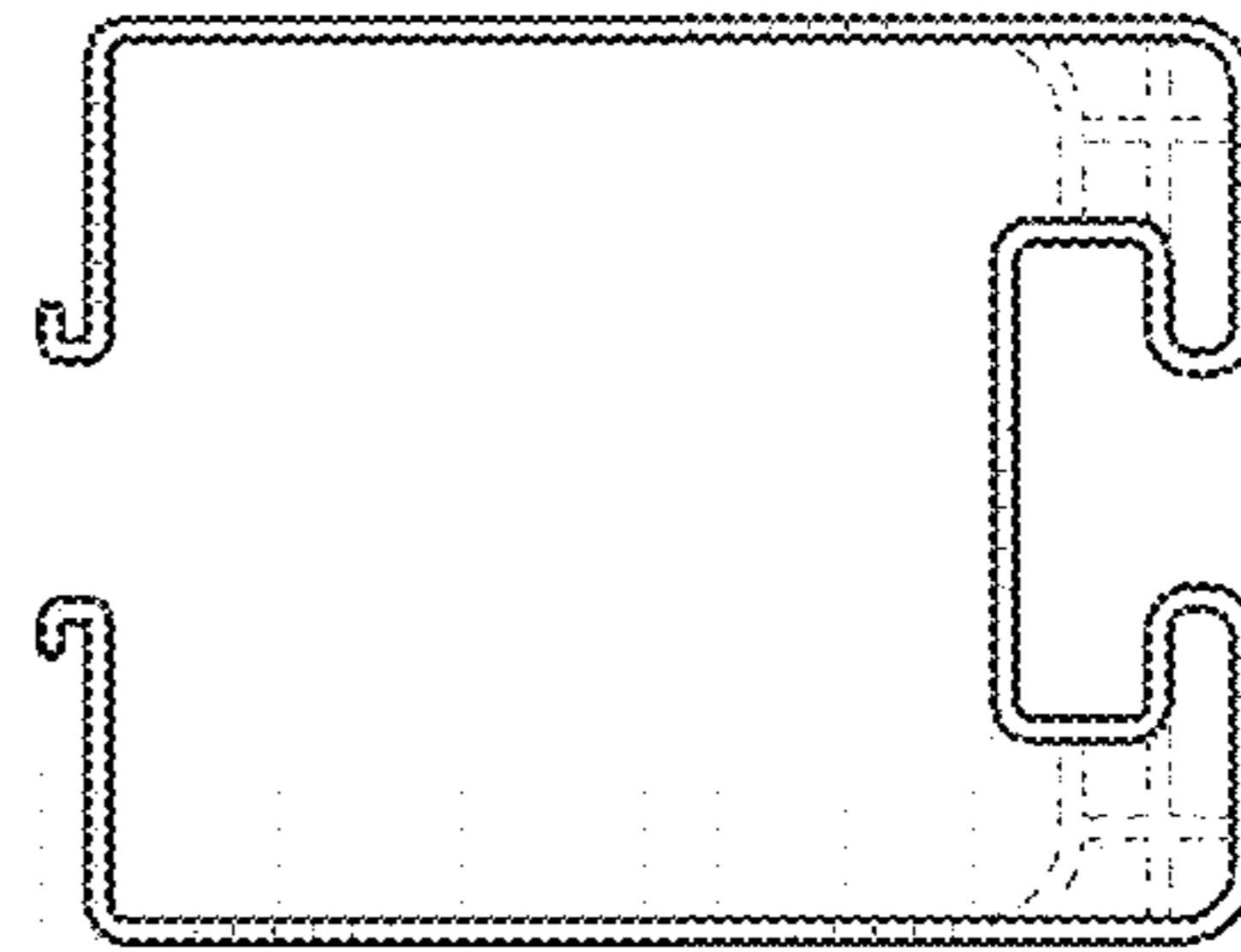

FIG. 6

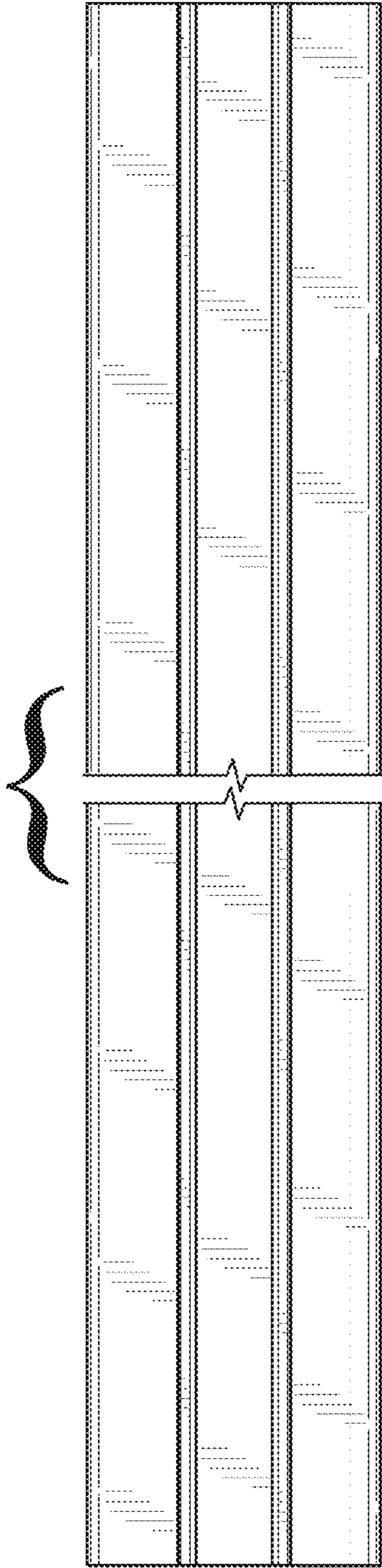

FIG. 7

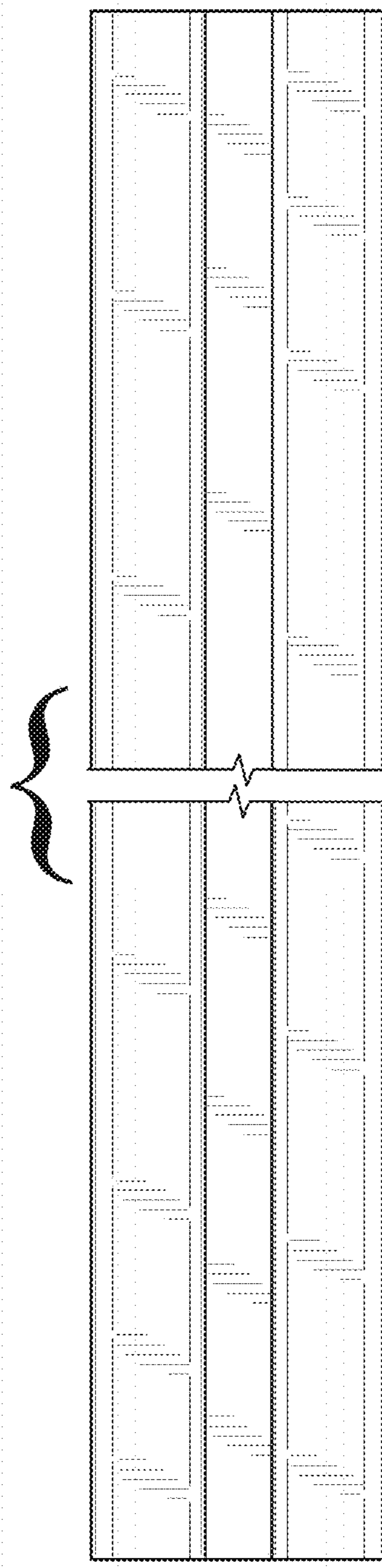

FIG. 8

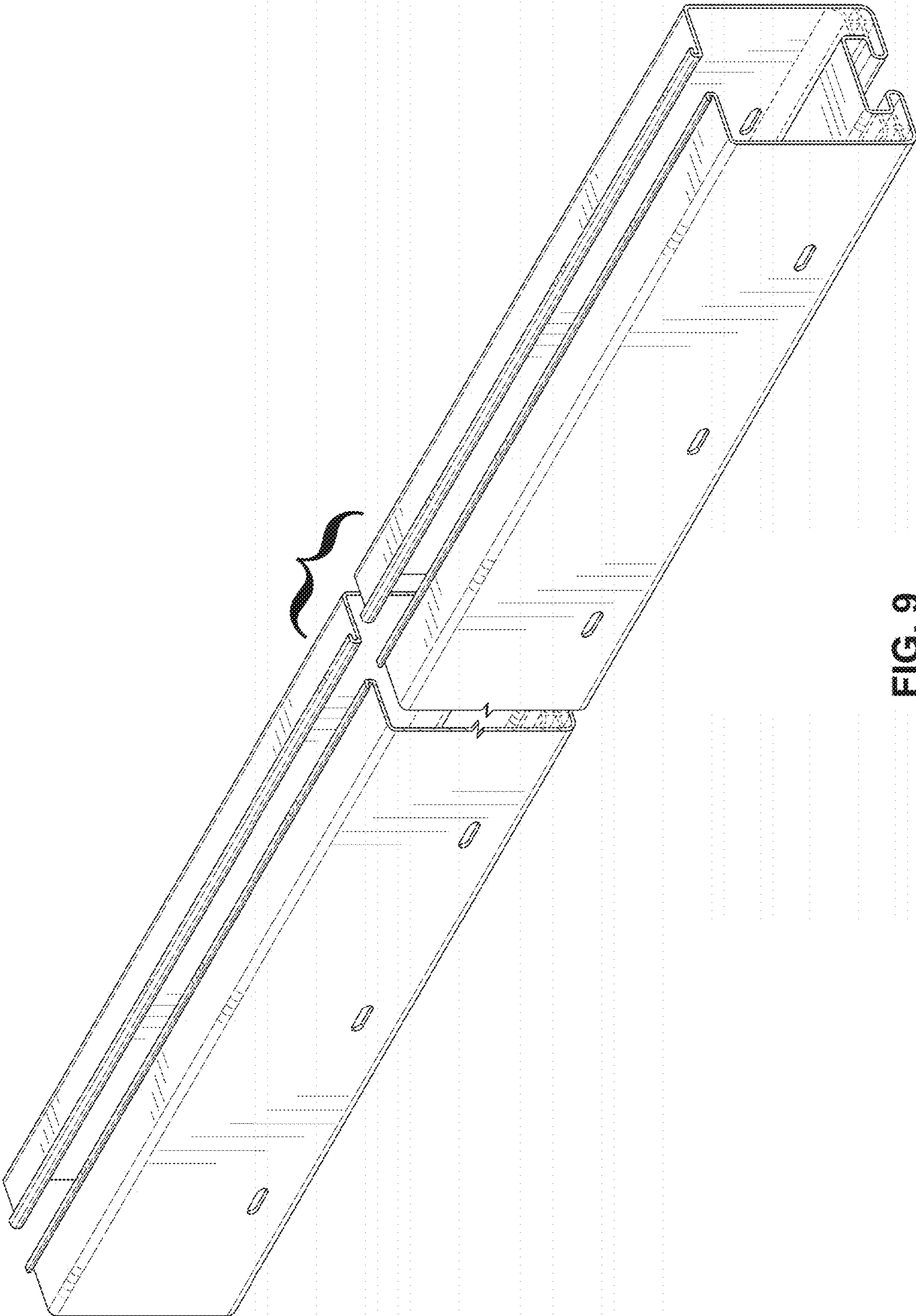

FIG. 9

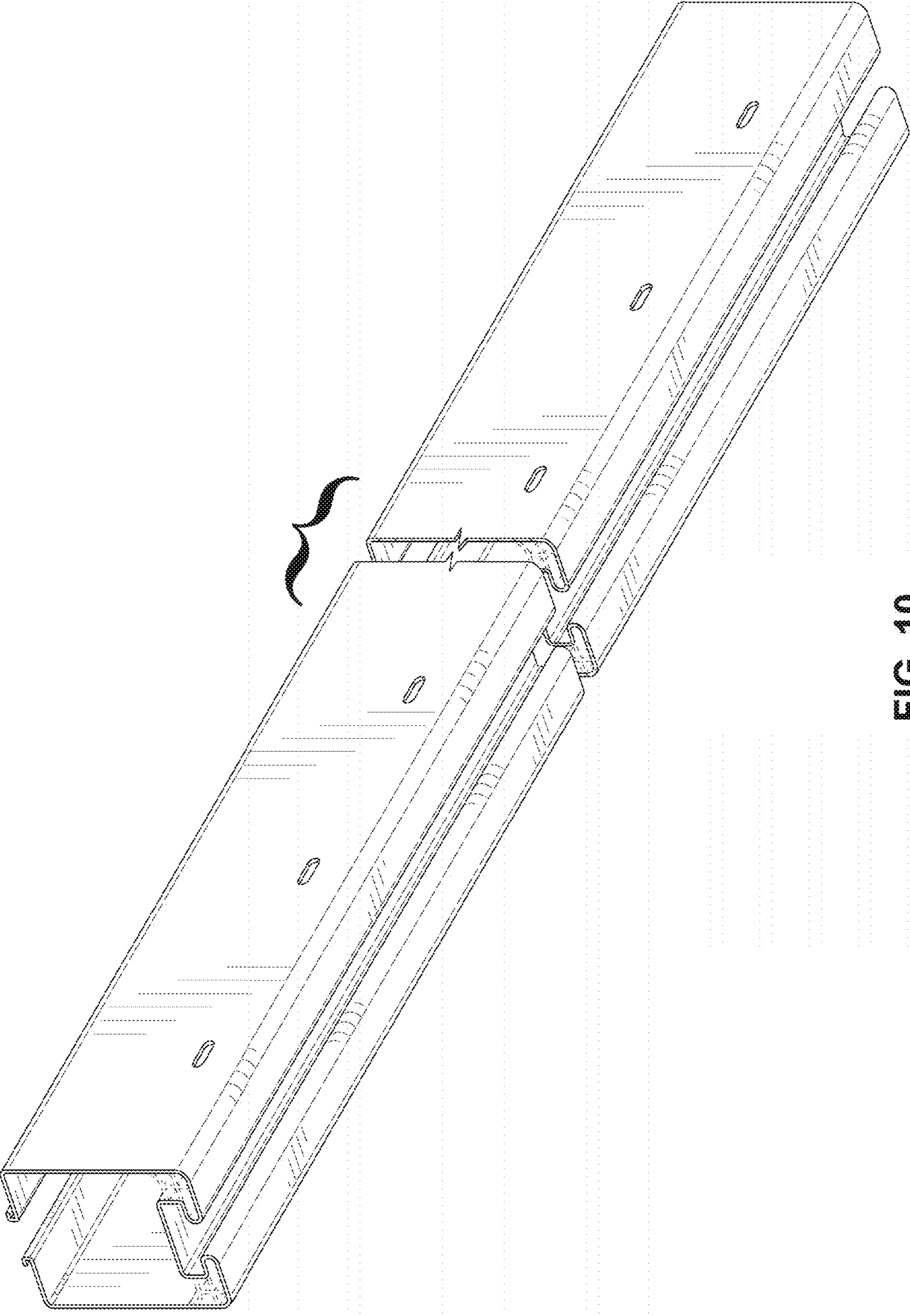

FIG. 10

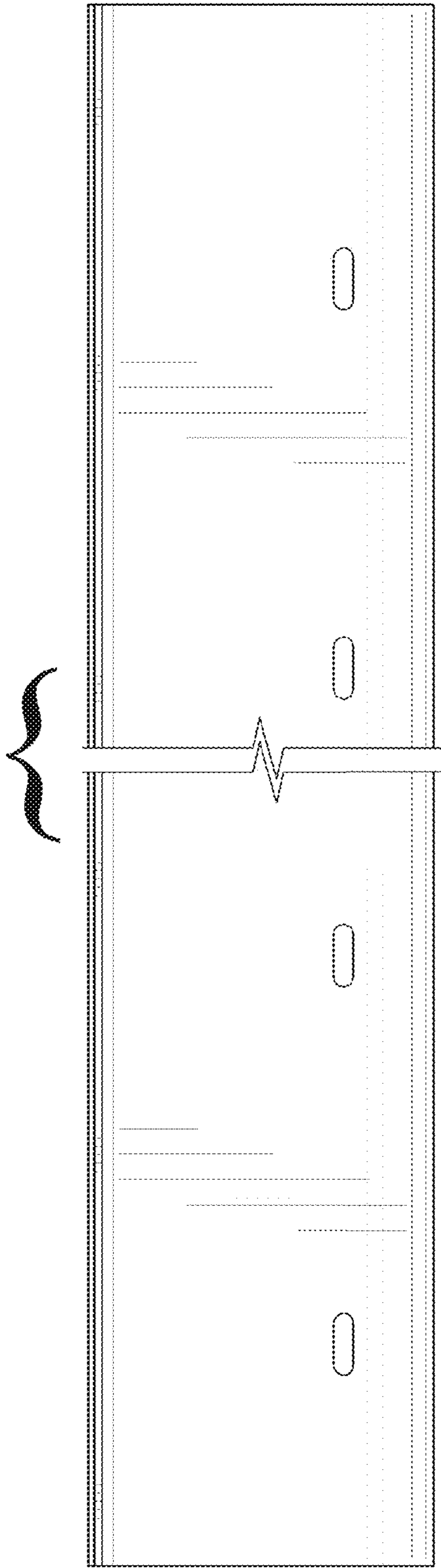

FIG. 11

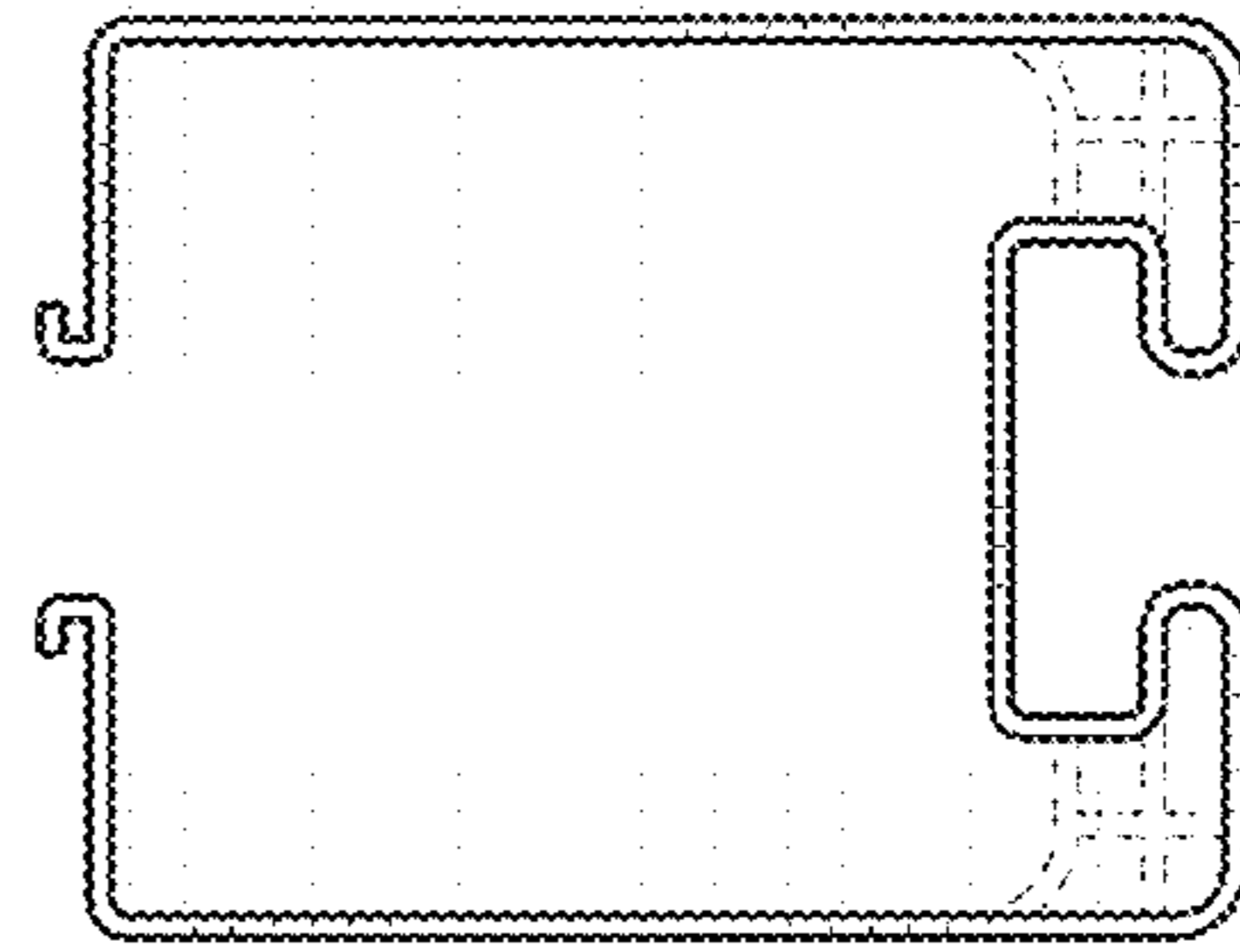

FIG. 12

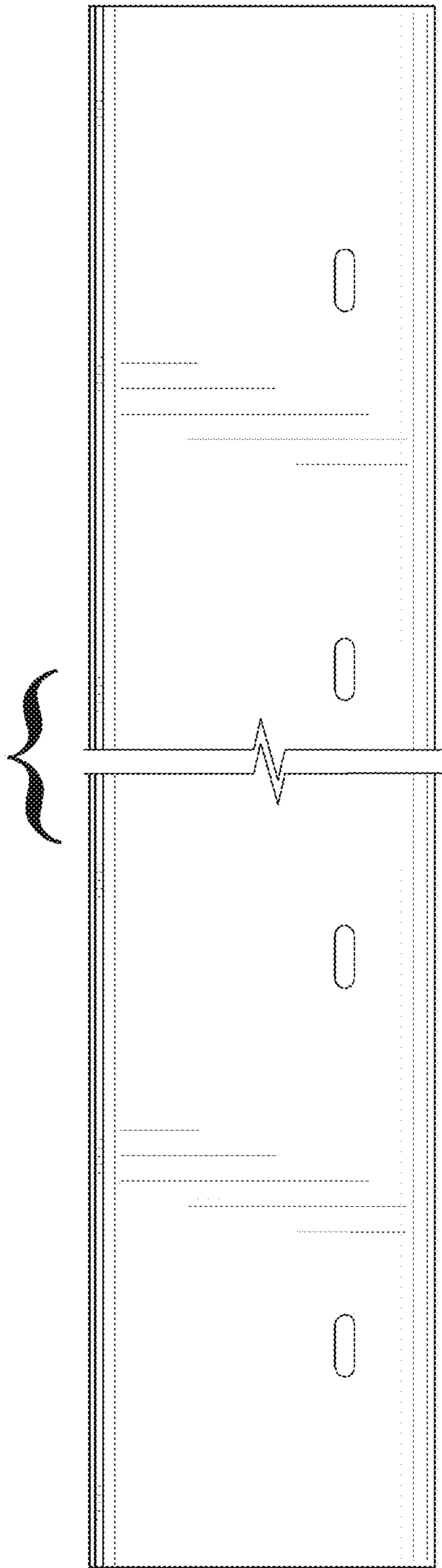

FIG. 13

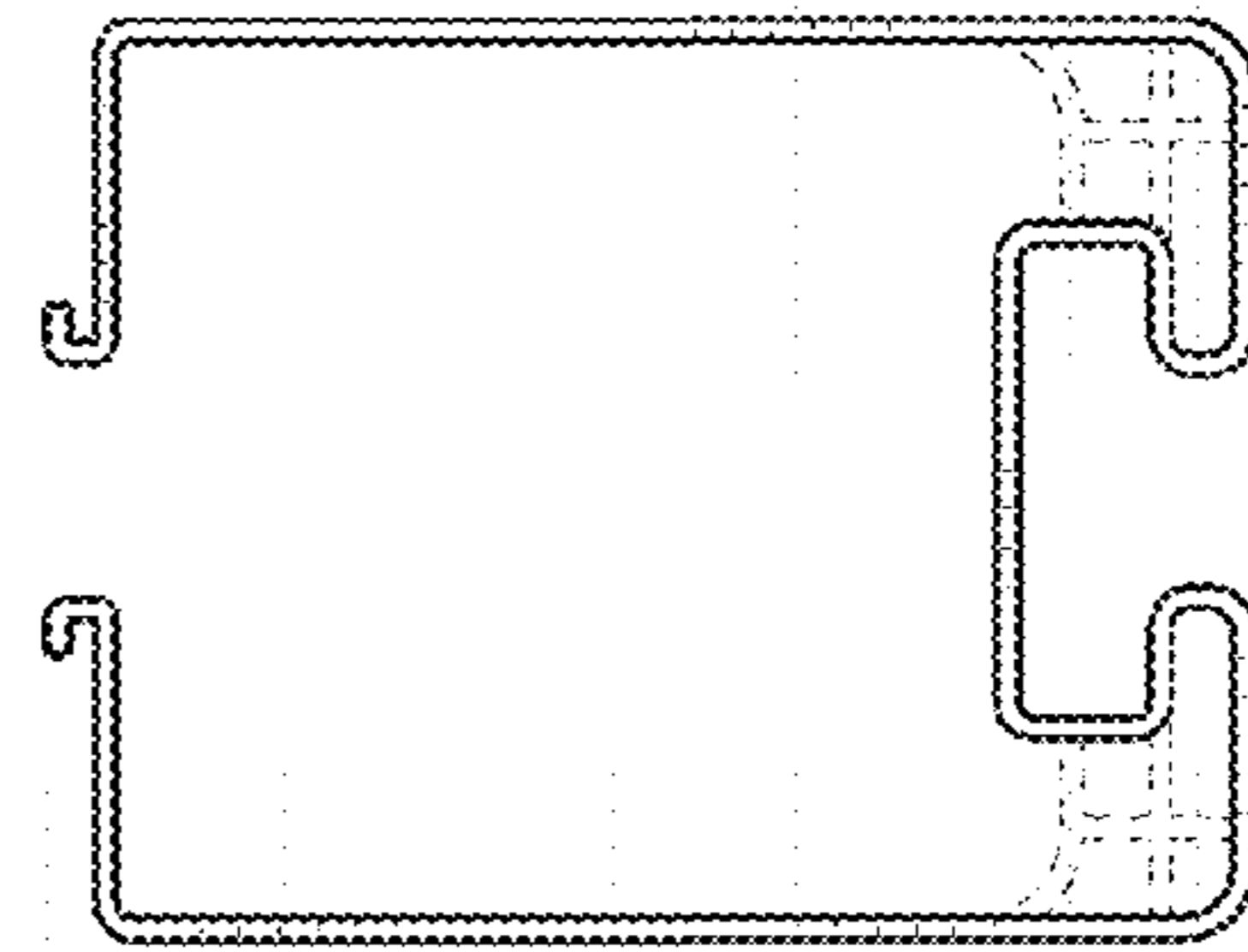

FIG. 14

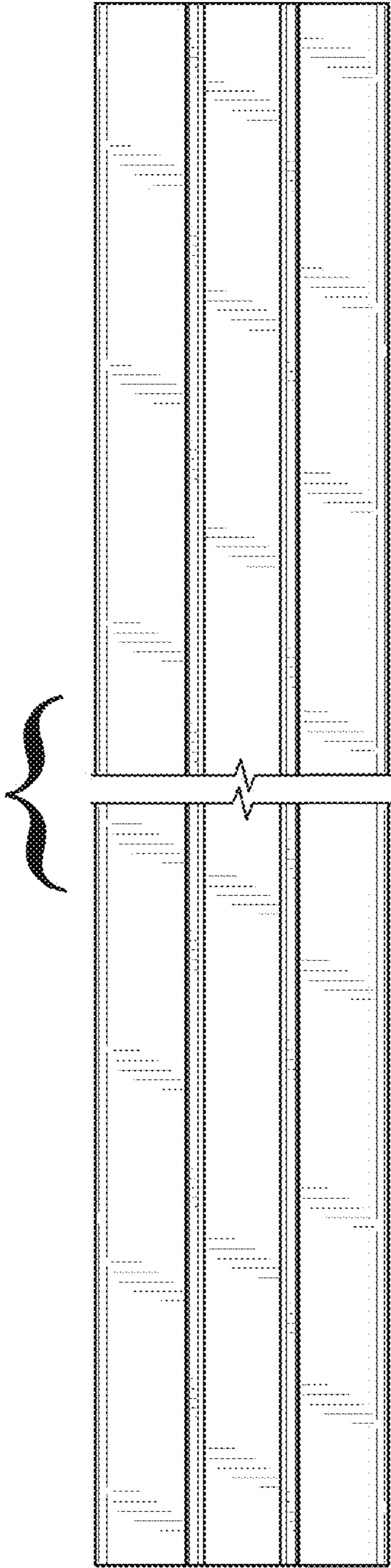

FIG. 15

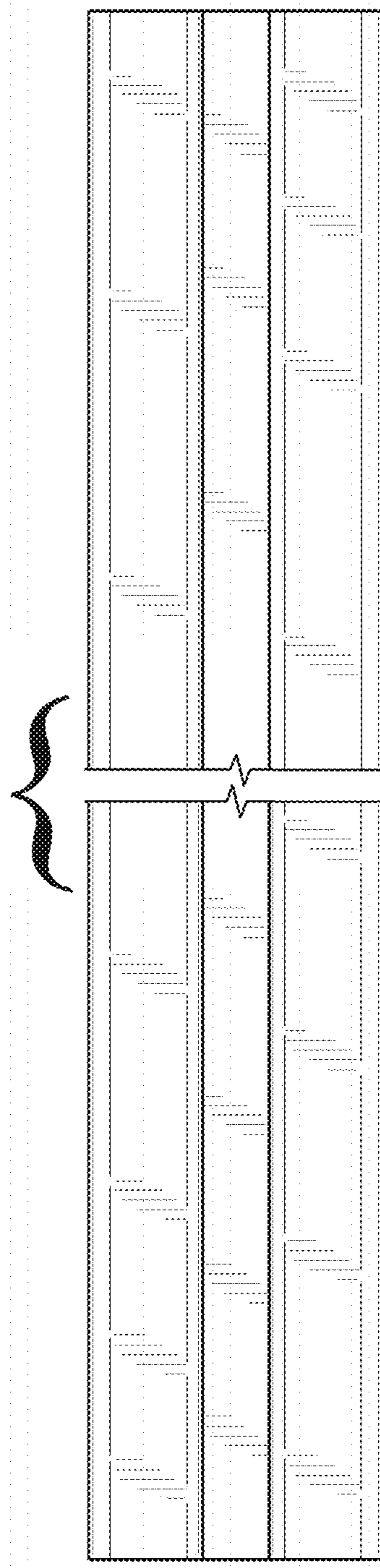

FIG. 16