



US00D908022S

(12) **United States Design Patent** (10) **Patent No.:** **US D908,022 S**
Cai (45) **Date of Patent:** **** Jan. 19, 2021**

(54) **PERSONAL ALARM**
(71) Applicant: **ShenZhen Indesign Technology Ltd.,**
Shenzhen (CN)
(72) Inventor: **Hongfa Cai, Shenzhen (CN)**
(**) Term: **15 Years**
(21) Appl. No.: **29/737,052**
(22) Filed: **Jun. 4, 2020**
(51) **LOC (13) Cl.** **10-05**
(52) **U.S. Cl.**
USPC **D10/106.1**
(58) **Field of Classification Search**
USPC D10/104.1, 106.1; D14/172
CPC G08B 15/004
See application file for complete search history.

D705,105 S * 5/2014 Solstad D10/106.1
D711,758 S * 8/2014 Heath et al.
D795,109 S * 8/2017 Olodort D10/104.1
D815,969 S * 4/2018 Ramasarma D10/104.1
D829,121 S * 9/2018 Colasse D10/106.1
D835,061 S * 12/2018 Baldree D14/172
10,546,484 B2 * 1/2020 Caren G08B 15/004

* cited by examiner

Primary Examiner — George D. Kirschbaum

(74) *Attorney, Agent, or Firm* — W&K IP

(57) **CLAIM**

The ornamental design for a personal alarm, as shown and described.

DESCRIPTION

FIG. 1 is a perspective view of a personal alarm;
FIG. 2 is a front elevational view thereof;
FIG. 3 is a rear elevational view thereof;
FIG. 4 is a left elevational view thereof;
FIG. 5 is a right elevational view thereof;
FIG. 6 is a top plan view thereof;
FIG. 7 is a bottom plan view thereof;
FIG. 8 is another perspective view thereof; and,
FIG. 9 is an enlarged view of portion of FIG. 8.
The evenly broken lines where present illustrate portions of the personal alarm that form no part of the claimed design.

(56) **References Cited**
U.S. PATENT DOCUMENTS
D362,816 S 10/1995 Yuen
5,475,368 A * 12/1995 Collins G08B 15/004
340/391.1
D418,769 S * 1/2000 Yuen D10/106.1
D431,486 S * 10/2000 Iseli D10/106.1
D483,281 S * 12/2003 Cobigo D10/104.1

1 Claim, 9 Drawing Sheets

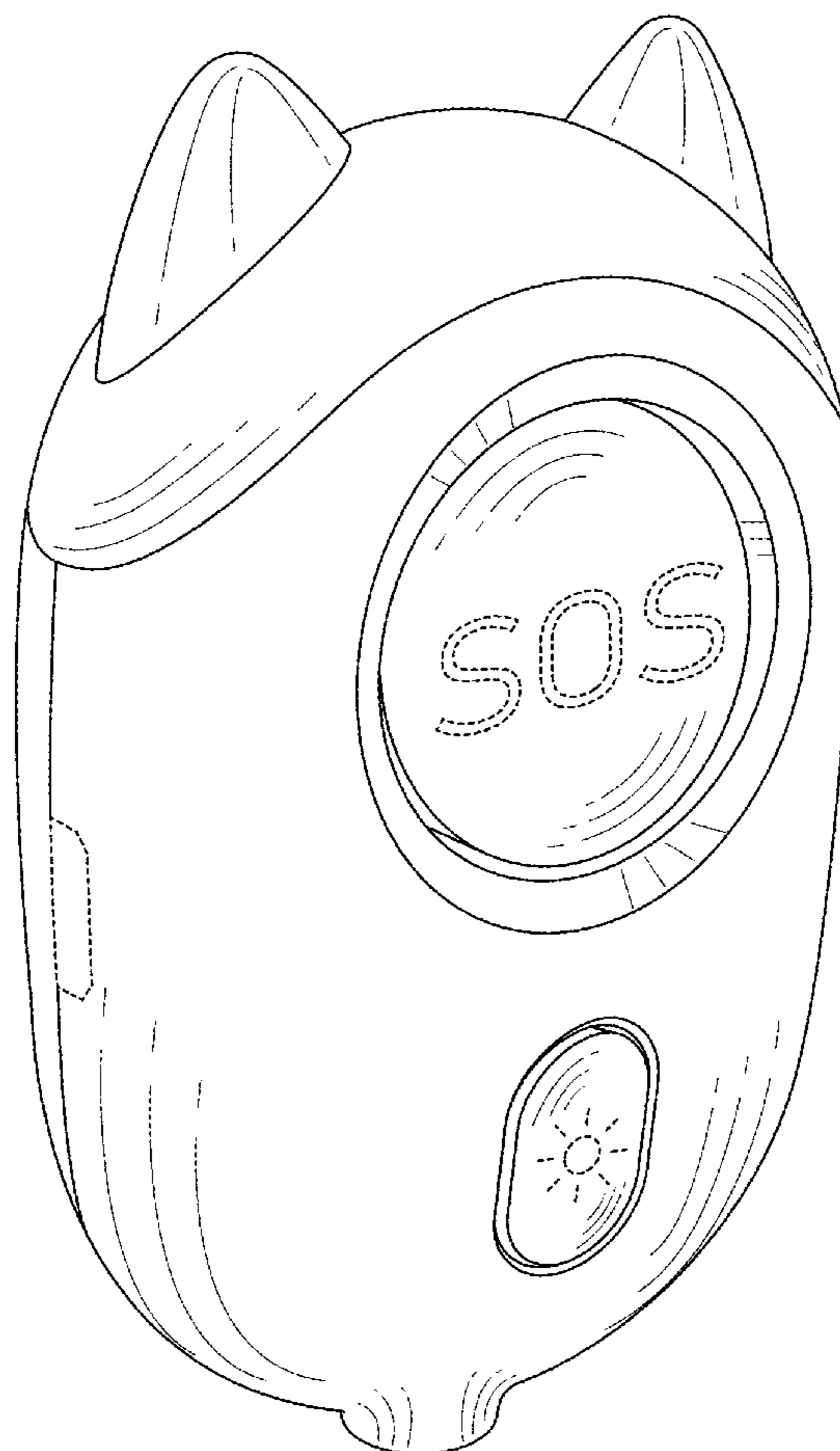

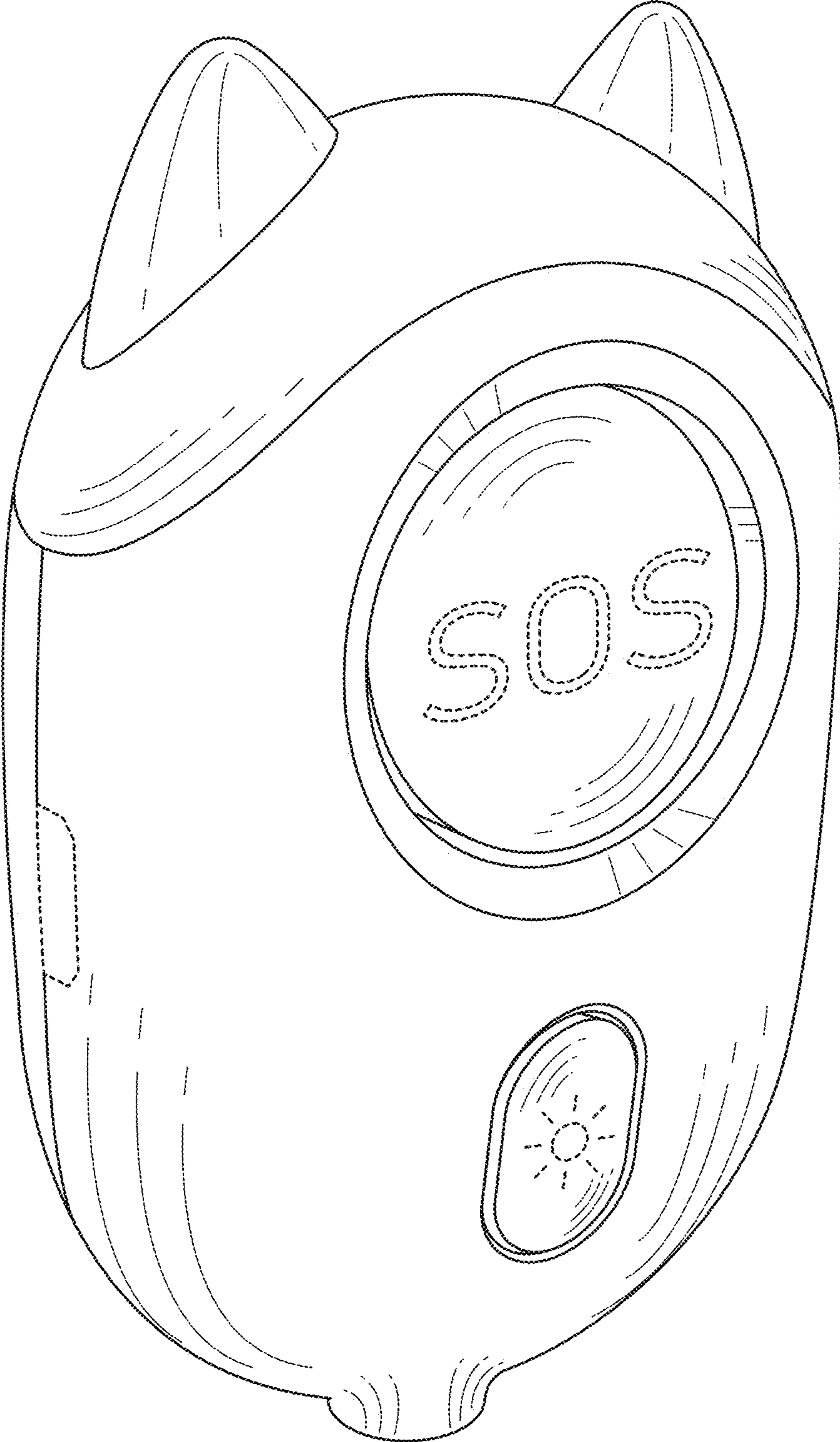

FIG.1

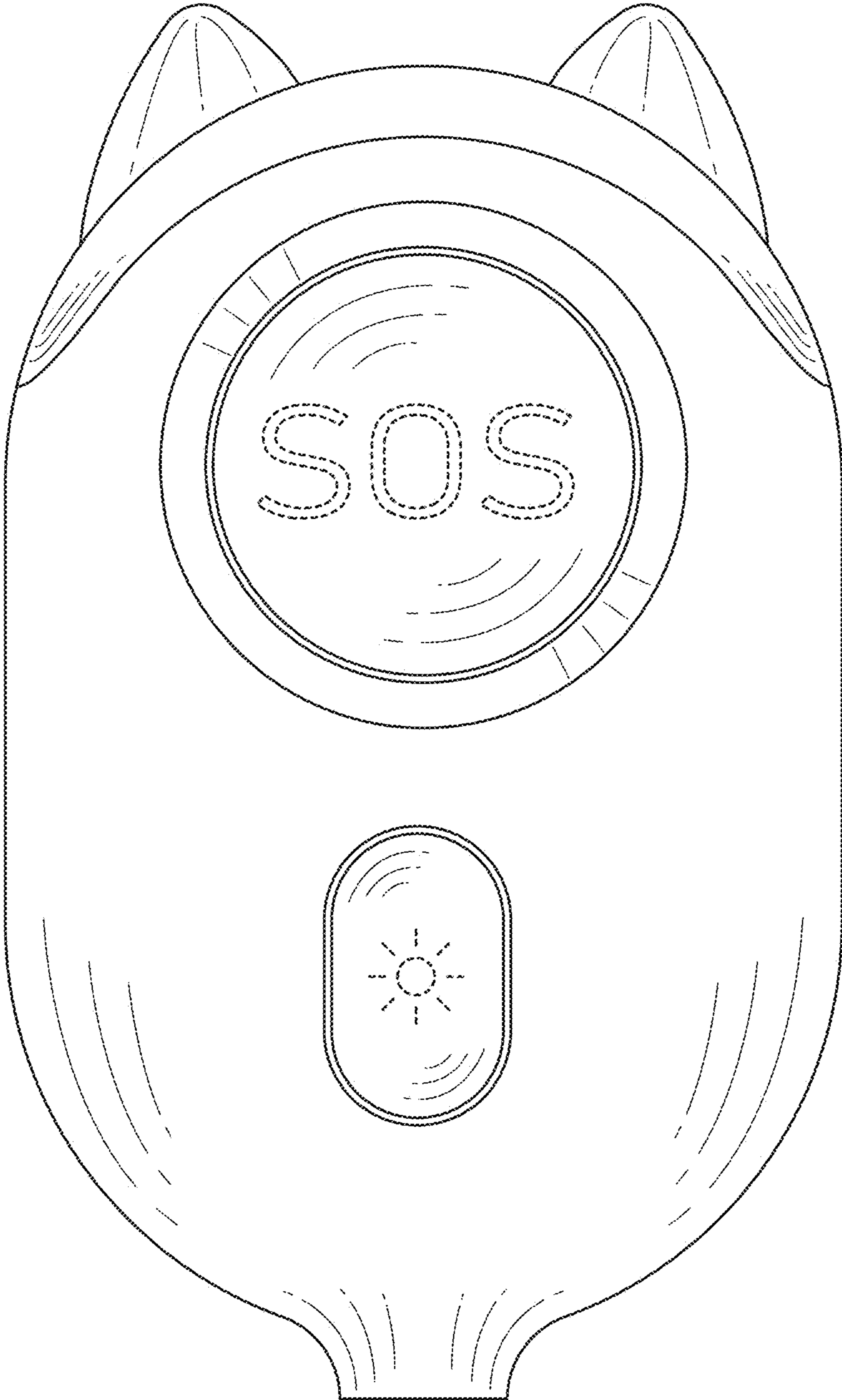

FIG.2

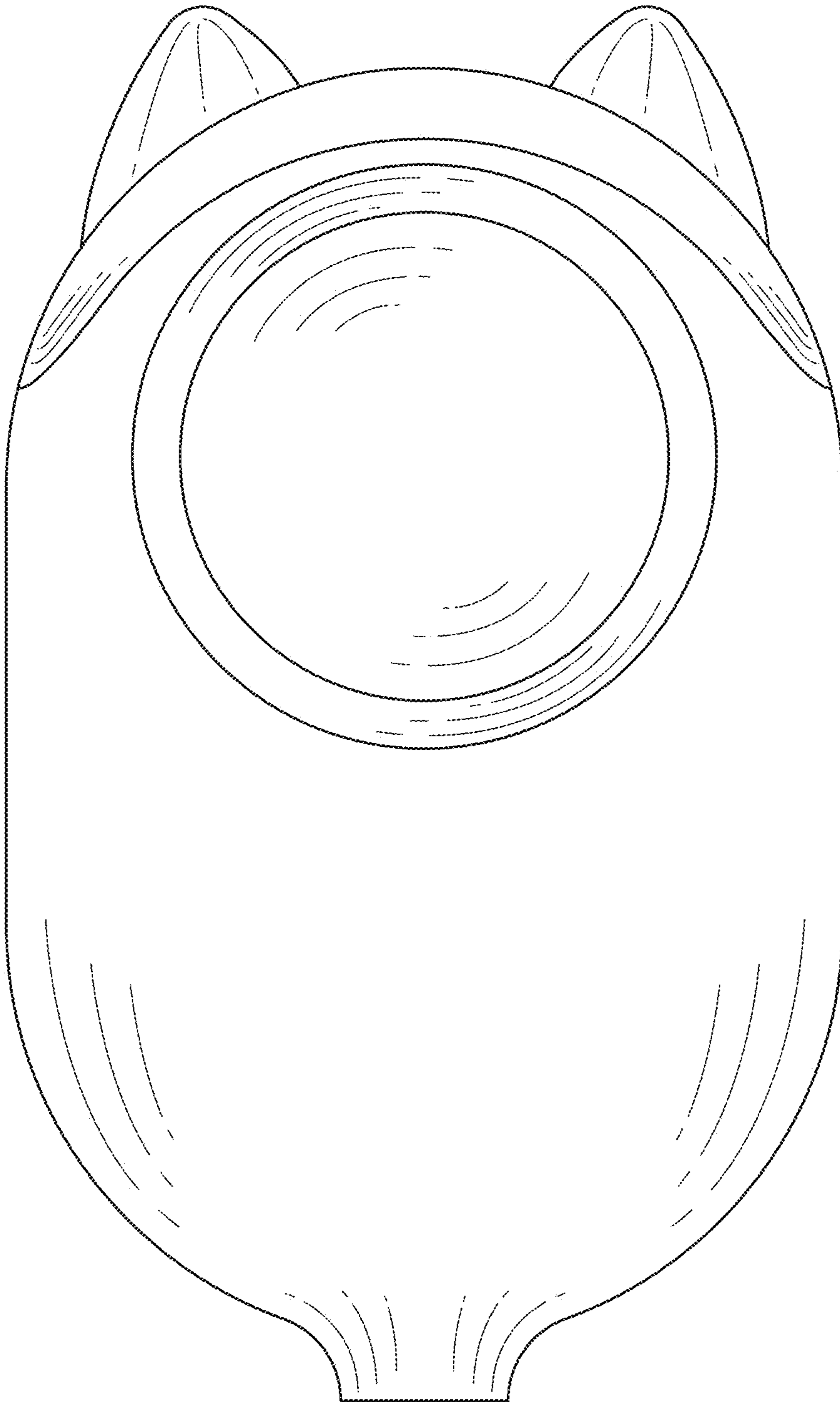

FIG.3

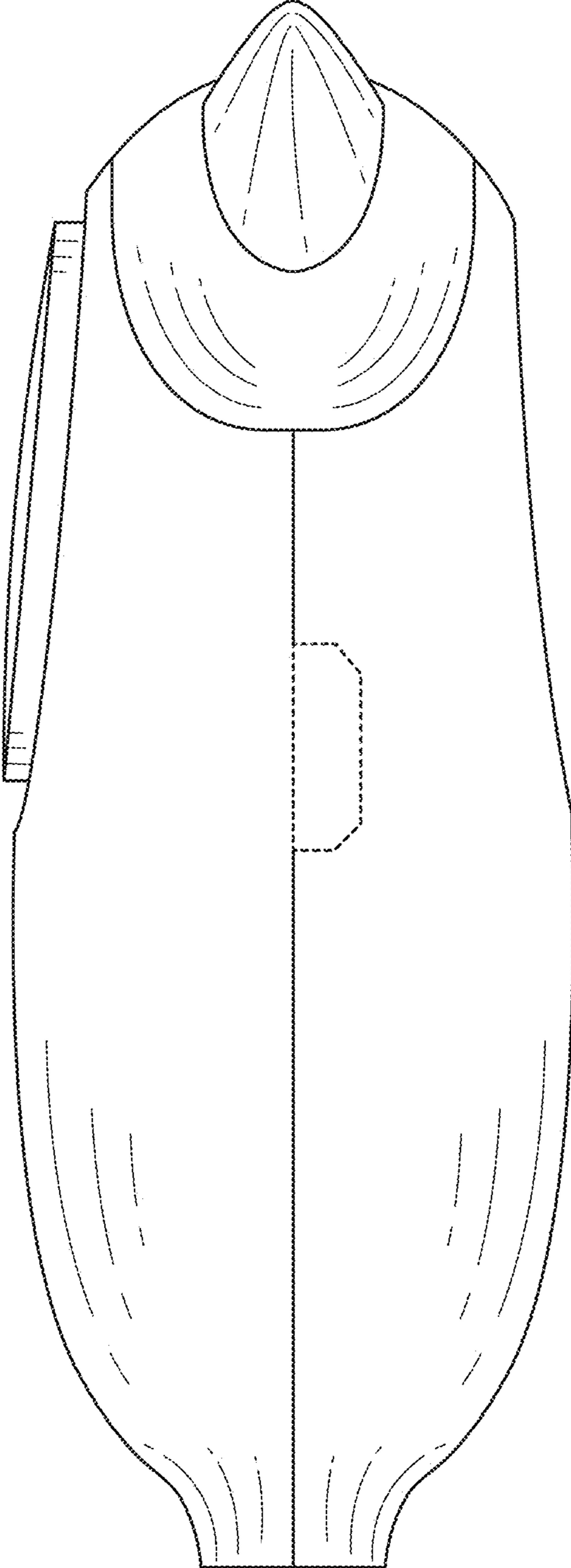

FIG.4

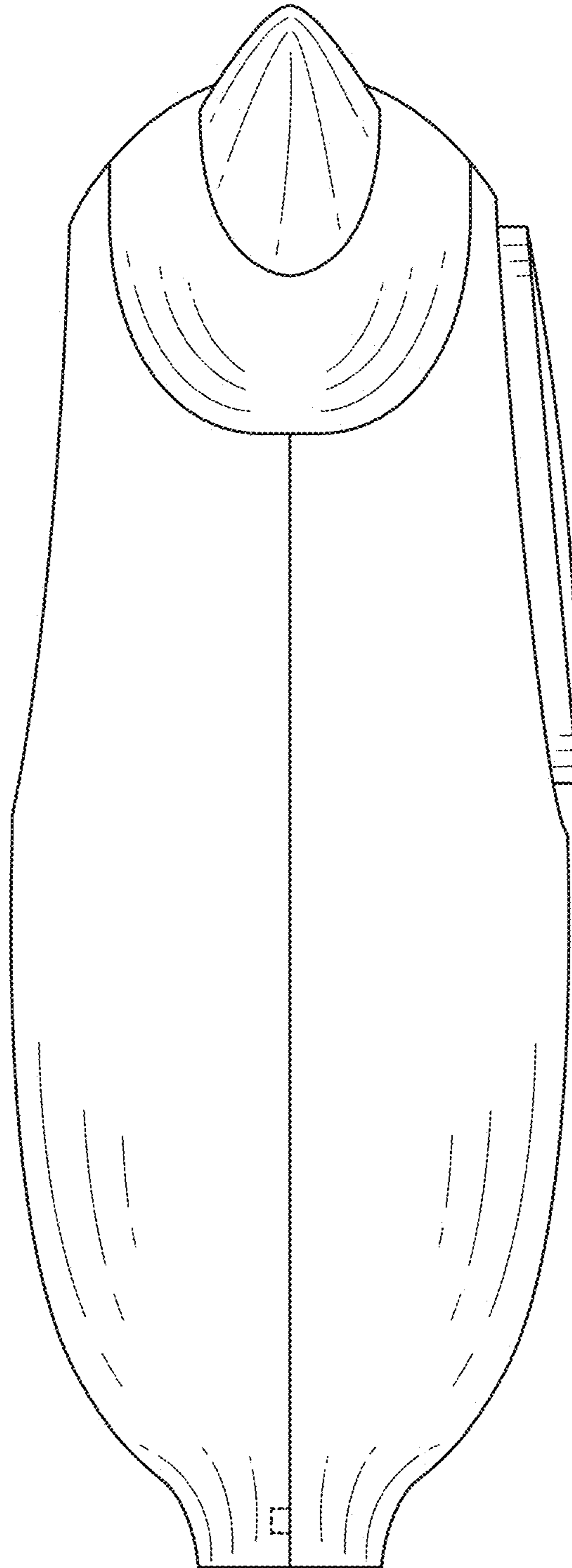

FIG.5

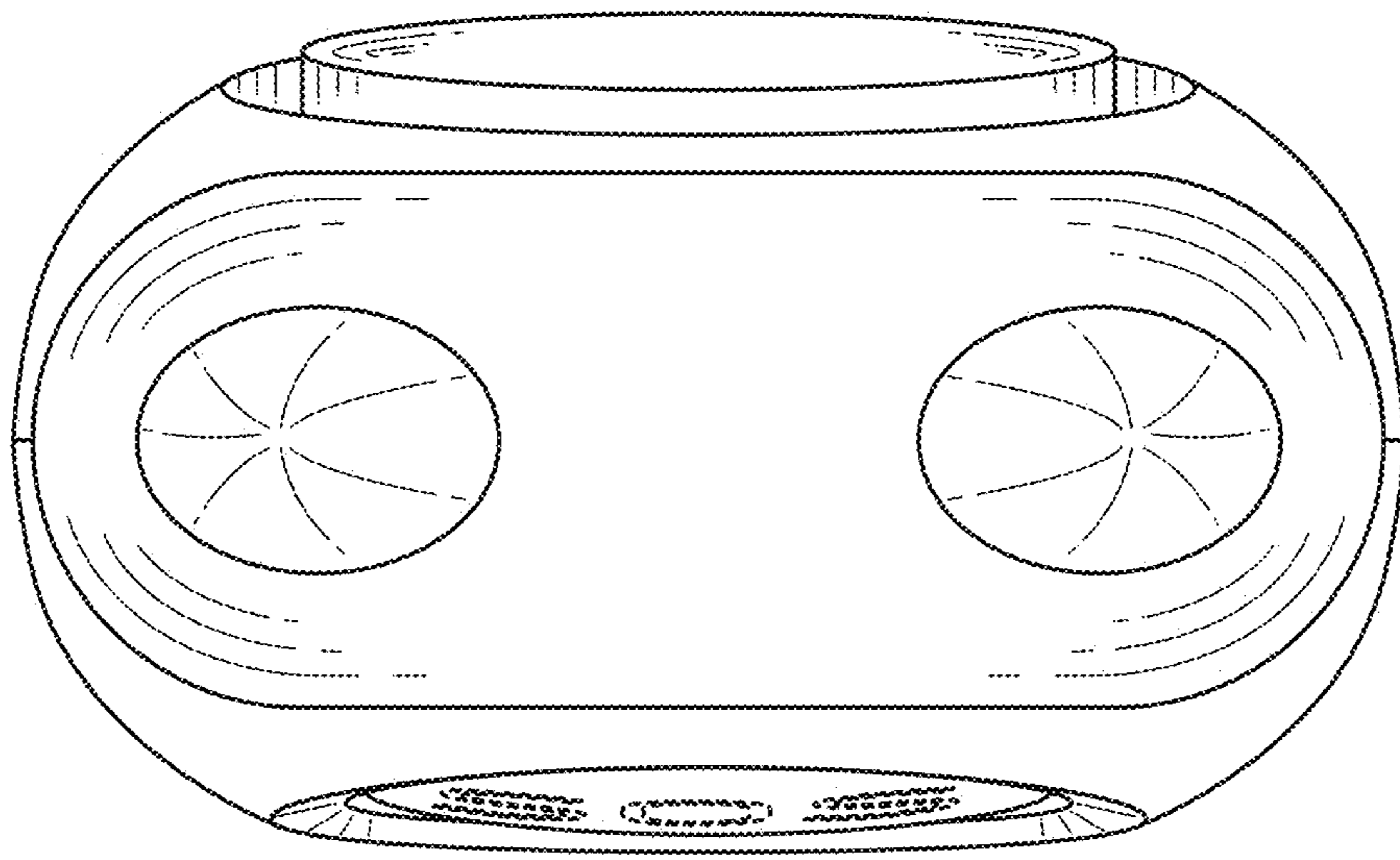

FIG.6

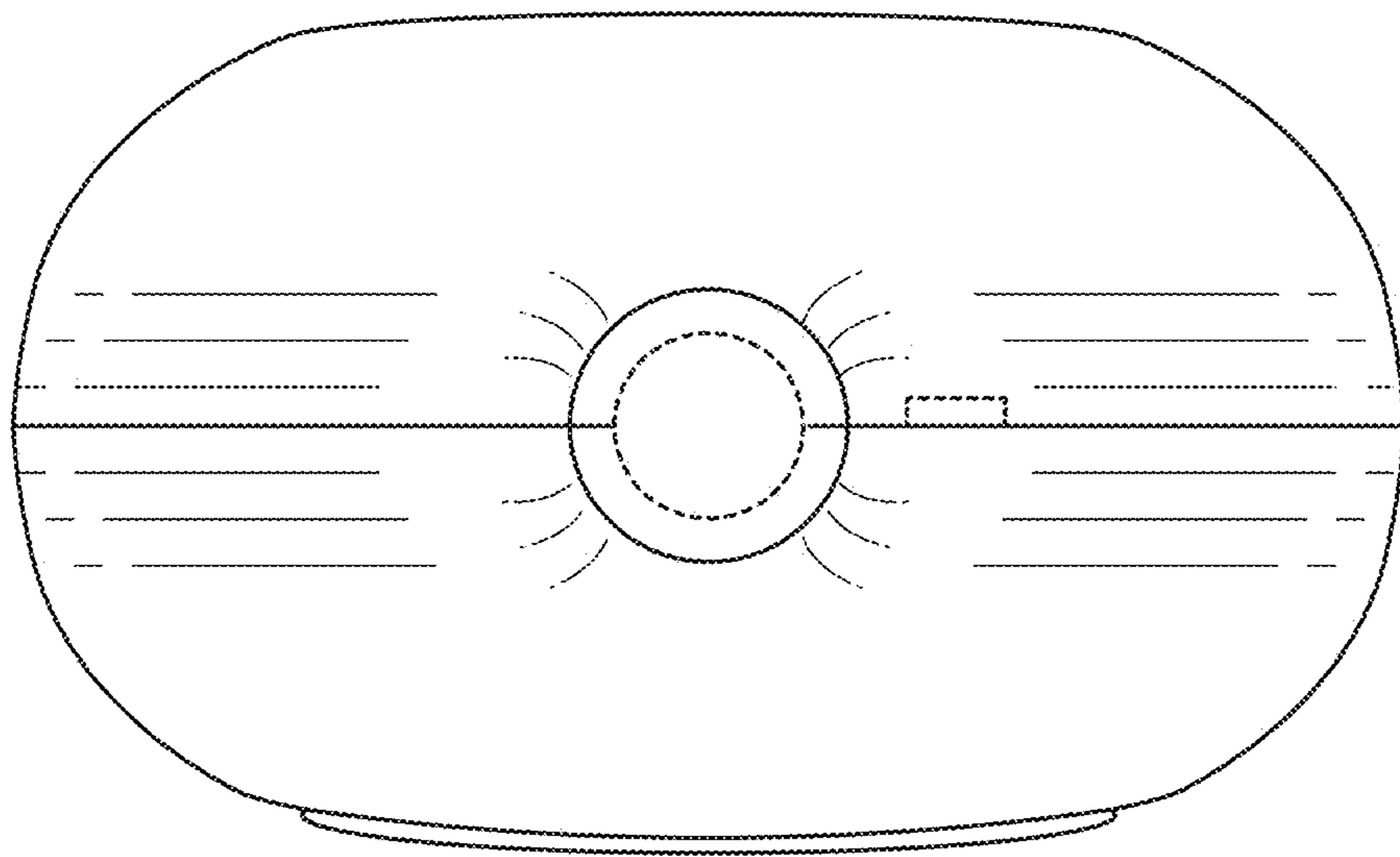

FIG. 7

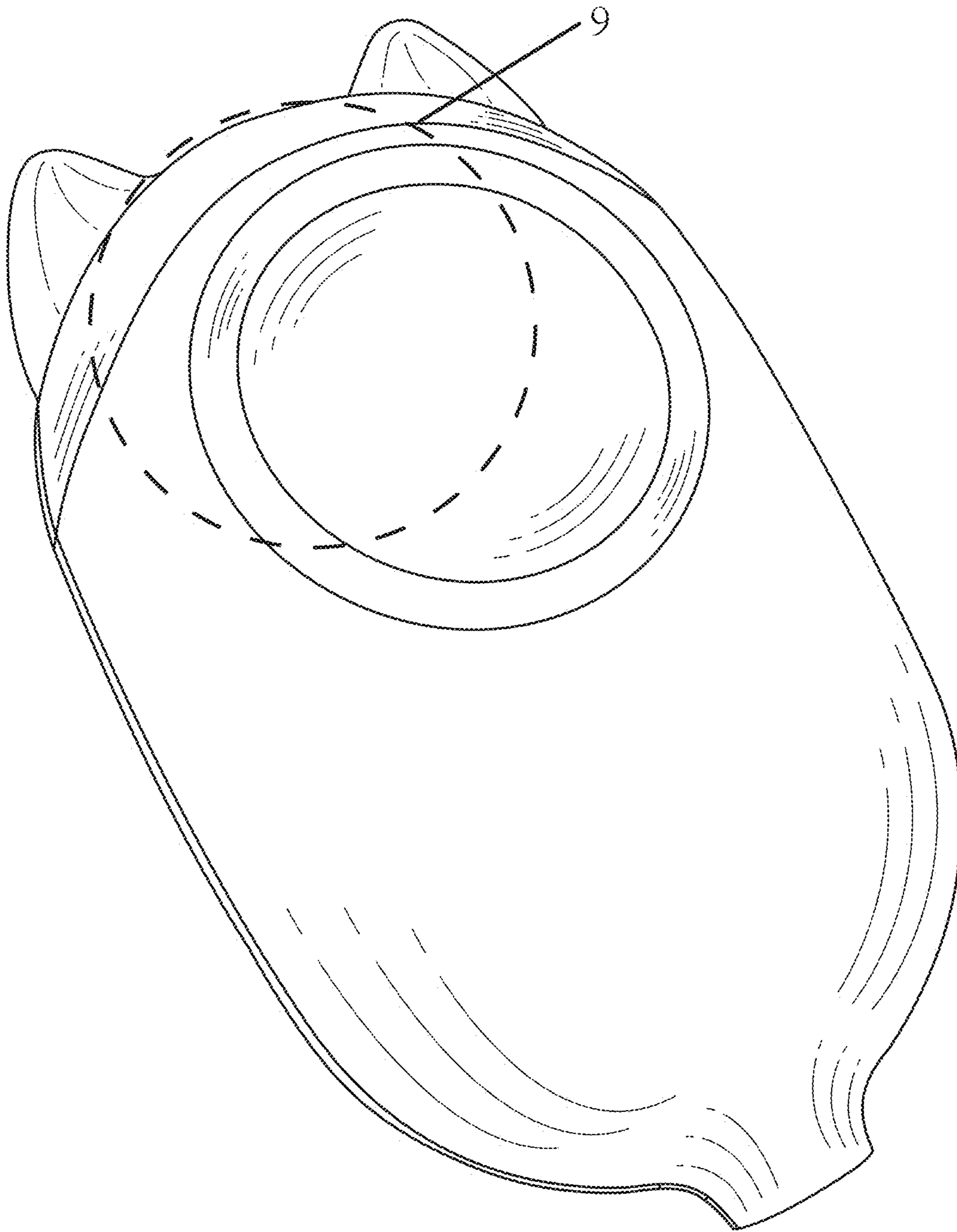

FIG.8

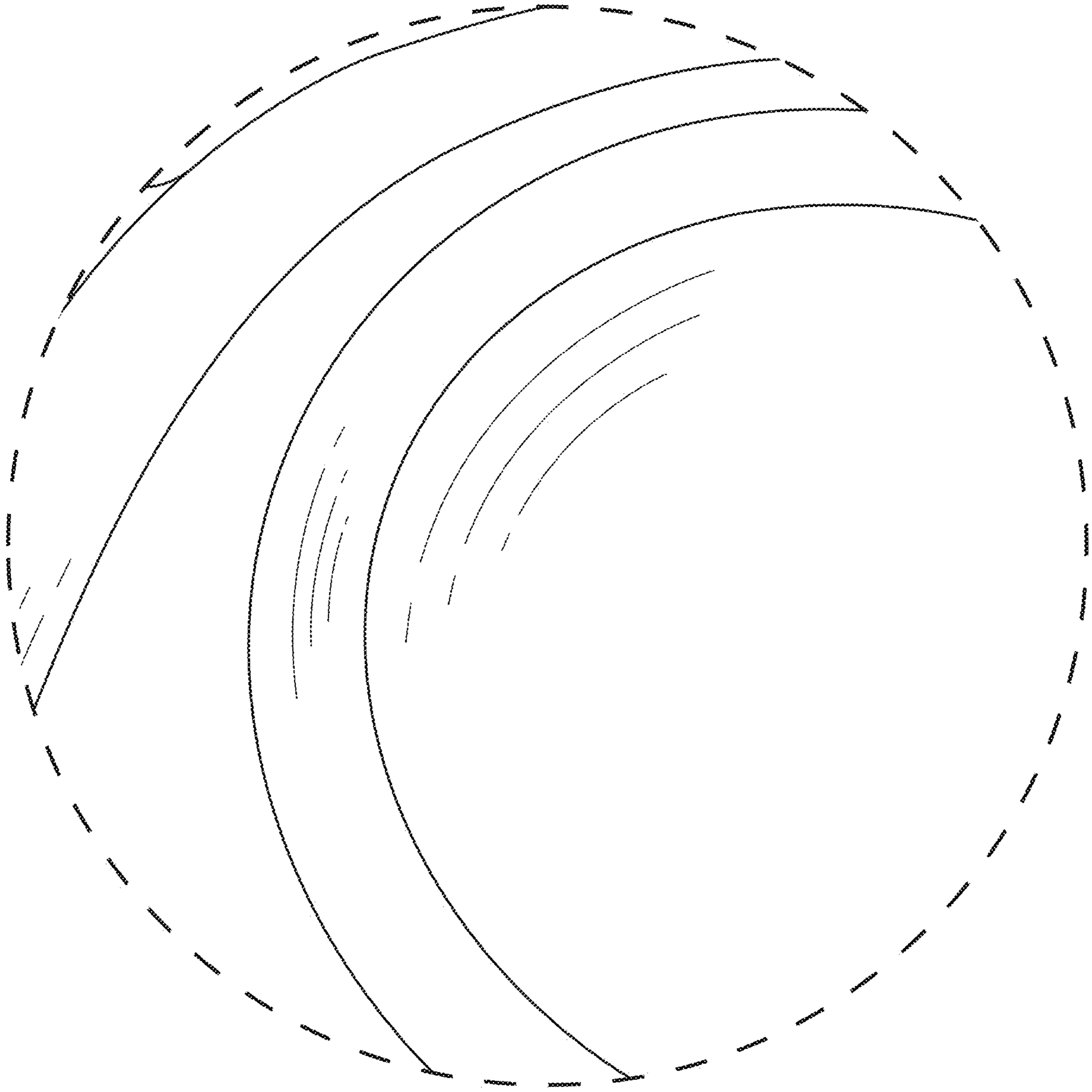

FIG.9