



US00D907962S

(12) **United States Design Patent** (10) **Patent No.:** **US D907,962 S**
Kim (45) **Date of Patent:** **** Jan. 19, 2021**

- (54) **TUMBLER**
- (71) Applicant: **Hyunsoo Kim**, Paju-si (KR)
- (72) Inventor: **Hyunsoo Kim**, Paju-si (KR)
- (**) Term: **15 Years**
- (21) Appl. No.: **29/703,686**
- (22) Filed: **Aug. 29, 2019**
- (30) **Foreign Application Priority Data**

D661,192 S *	6/2012	Hwang	D9/504
D697,410 S *	1/2014	Glasman	D9/503
D739,740 S *	9/2015	Sturdevant	D9/504
D782,313 S *	3/2017	Roser	D9/516
D817,115 S *	5/2018	Peng	D7/629
D832,708 S *	11/2018	Roser	D9/504
D838,141 S *	1/2019	Bertsch	D7/510
D845,766 S *	4/2019	Tartock	D9/454
D846,354 S *	4/2019	Omdahl, II	D7/510
D847,575 S *	5/2019	Rollens	D7/510
D847,638 S *	5/2019	Moretti	D9/500
D863,966 S *	10/2019	Kauffman	D9/504
D871,844 S *	1/2020	Adams, Jr.	D7/510
D876,173 S *	2/2020	Kotani	D7/608
D878,156 S *	3/2020	Rittri	D7/511

Aug. 20, 2019 (KR) 30-2019-0039721

- (51) **LOC (13) Cl.** **07-01**
- (52) **U.S. Cl.**
USPC **D7/523**; D7/532; D7/511
- (58) **Field of Classification Search**
USPC D7/507, 509, 510, 511, 529, 531, 532,
D7/523, 533, 534, 535, 536, 392.1, 296.1,
D7/396.2, 300.1, 608, 624.1, 624.2, 602,
D7/601; D3/202; D26/9; D9/501, 503,
D9/504
CPC A47G 19/22; A47G 19/2288; A47G
19/2205; A47J 41/0077; A47J 41/0088
See application file for complete search history.

* cited by examiner

Primary Examiner — Jae Liang
(74) *Attorney, Agent, or Firm* — KORUS Patent, LLC;
Seong Il Jeong

(56) **References Cited**

U.S. PATENT DOCUMENTS

D278,121 S *	3/1985	Sussman	D9/504
D316,371 S *	4/1991	Vola	D9/504
5,052,592 A *	10/1991	Wilken	B65D 83/0033 222/212
D438,376 S *	3/2001	Marshall	D3/257
D461,290 S *	8/2002	Shilling	D34/1
D497,778 S *	11/2004	Rich	D7/608
D516,766 S *	3/2006	Daams	D19/85
D545,676 S *	7/2007	Rica	D9/439
D637,997 S *	5/2011	Peller	D14/205

(57) **CLAIM**

The ornamental design for a tumbler, as shown and described.

DESCRIPTION

FIG. 1 is a front perspective view of a tumbler in accordance with the present design;
FIG. 2 is a front view thereof;
FIG. 3 is a rear view thereof;
FIG. 4 is a left side view thereof;
FIG. 5 is a right side view thereof;
FIG. 6 is a top plan view thereof;
FIG. 7 is a bottom plan view thereof; and,
FIG. 8 is an exploded view thereof.
The broken line showing of parts in FIG. 8 is included for the purpose of illustrating use and forms no part of the claimed design.

1 Claim, 7 Drawing Sheets

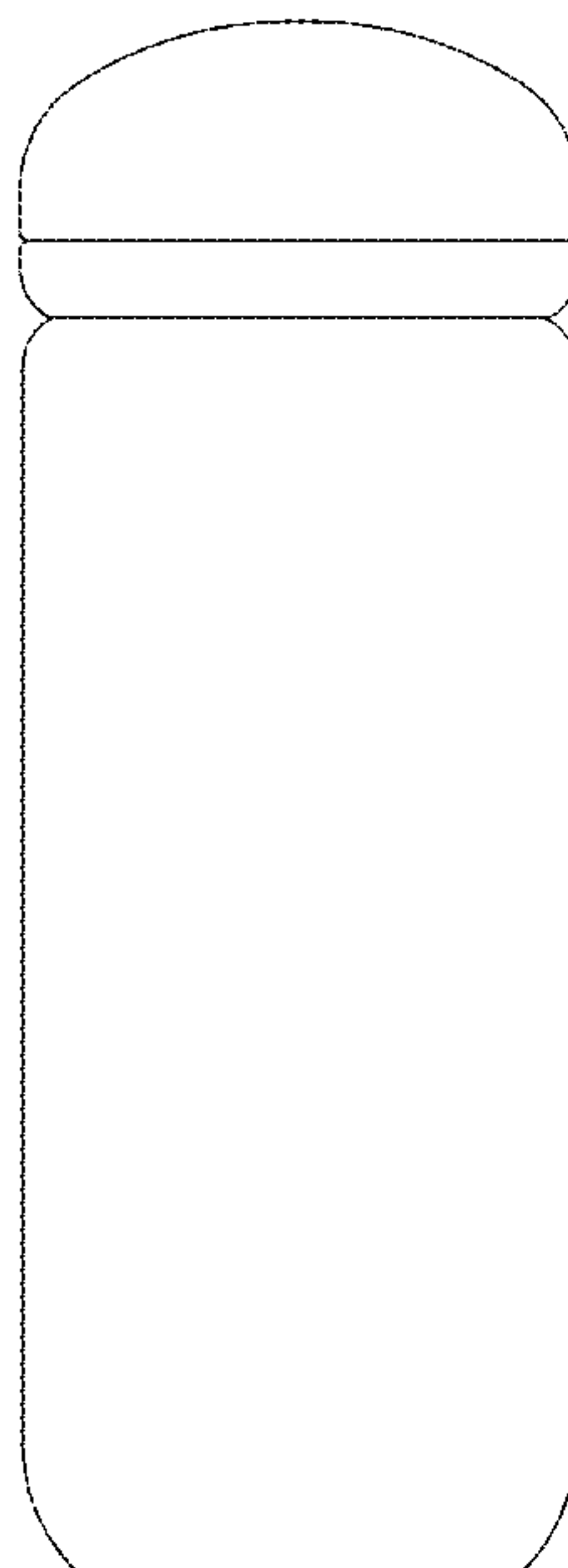

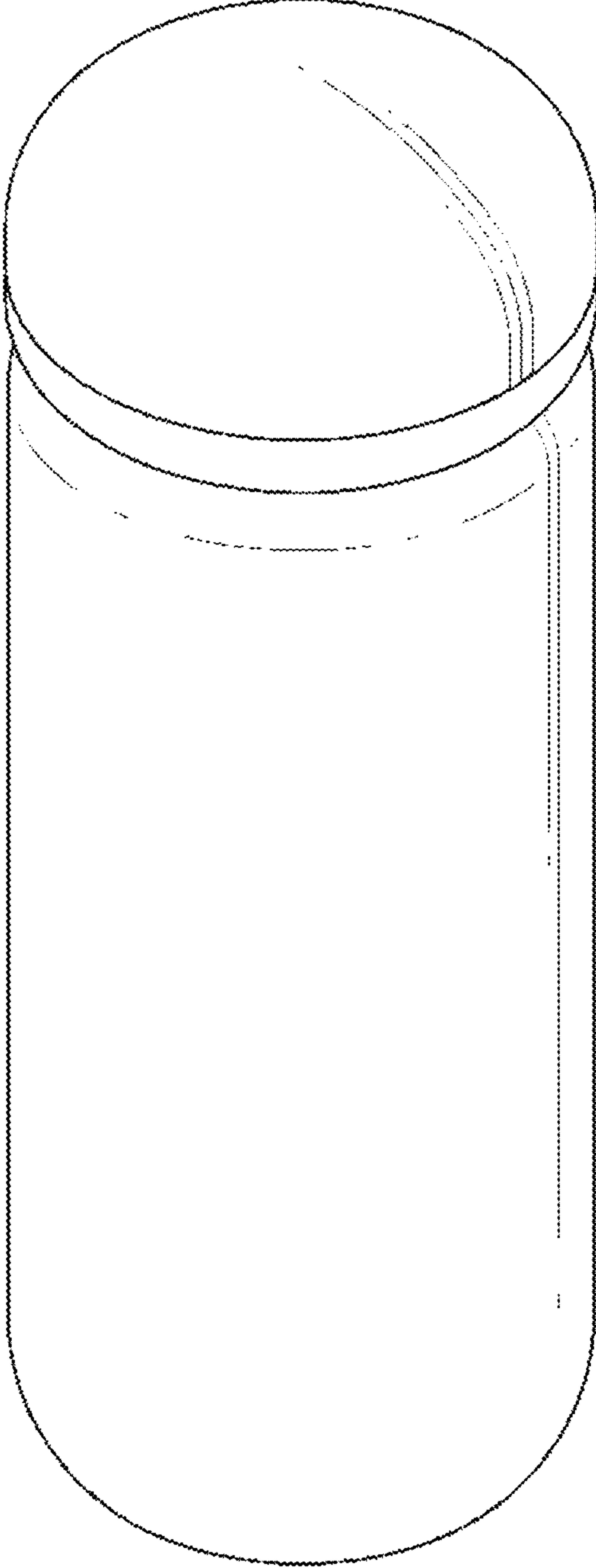

FIG. 1

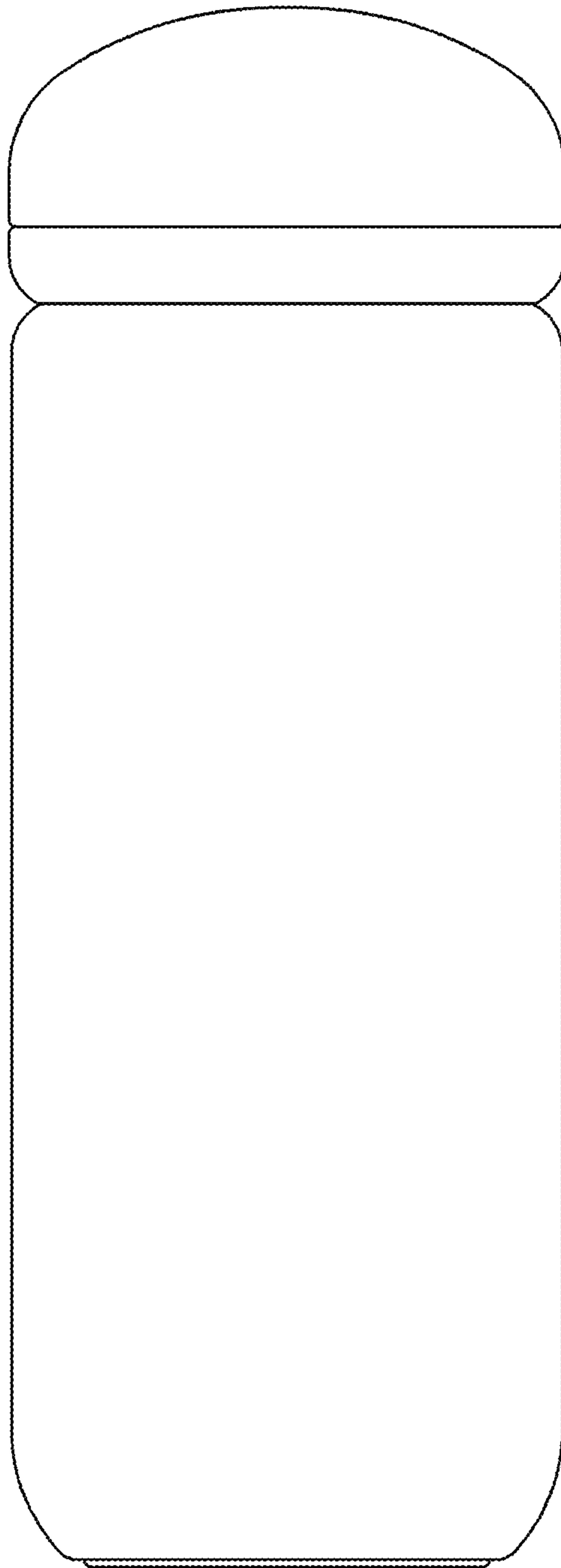

FIG.2

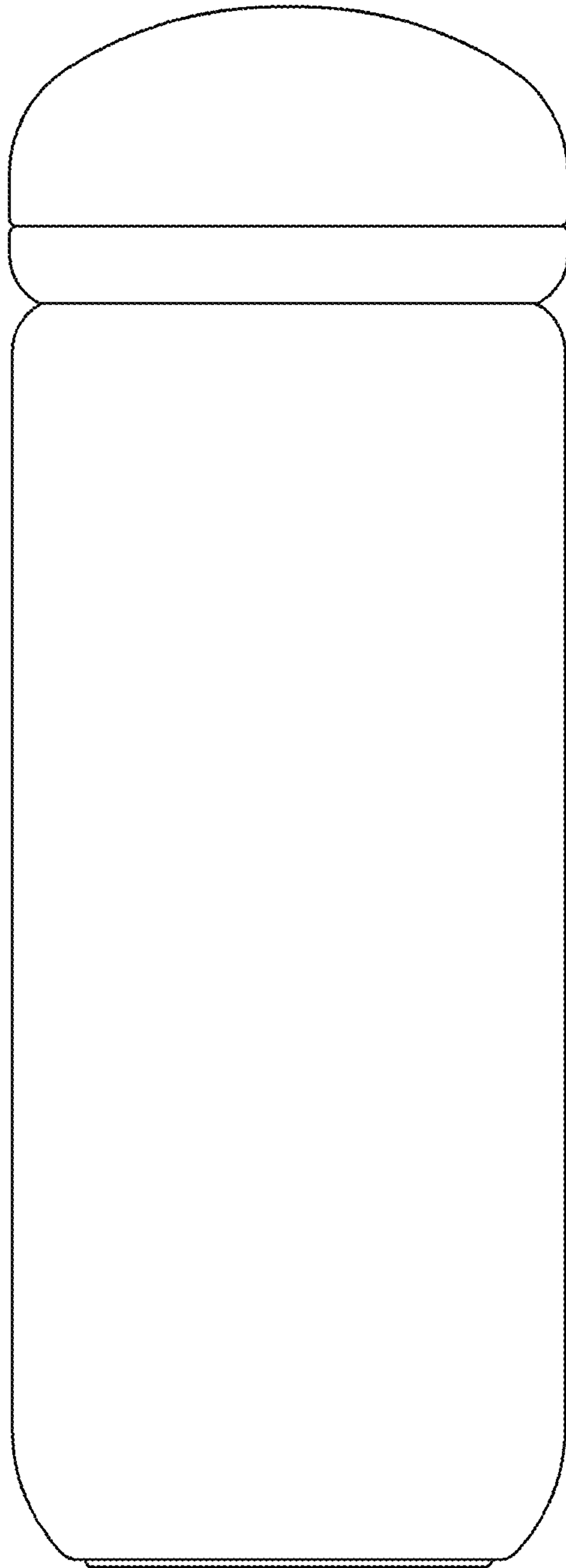

FIG. 3

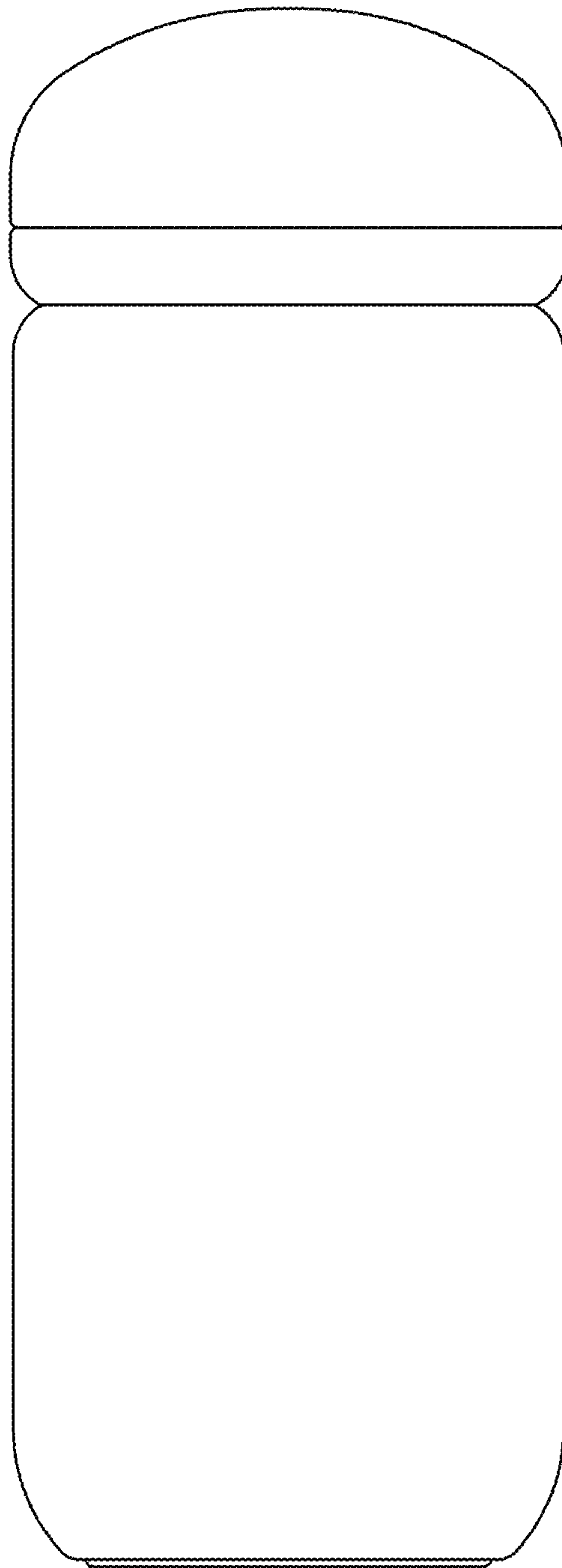

FIG.4

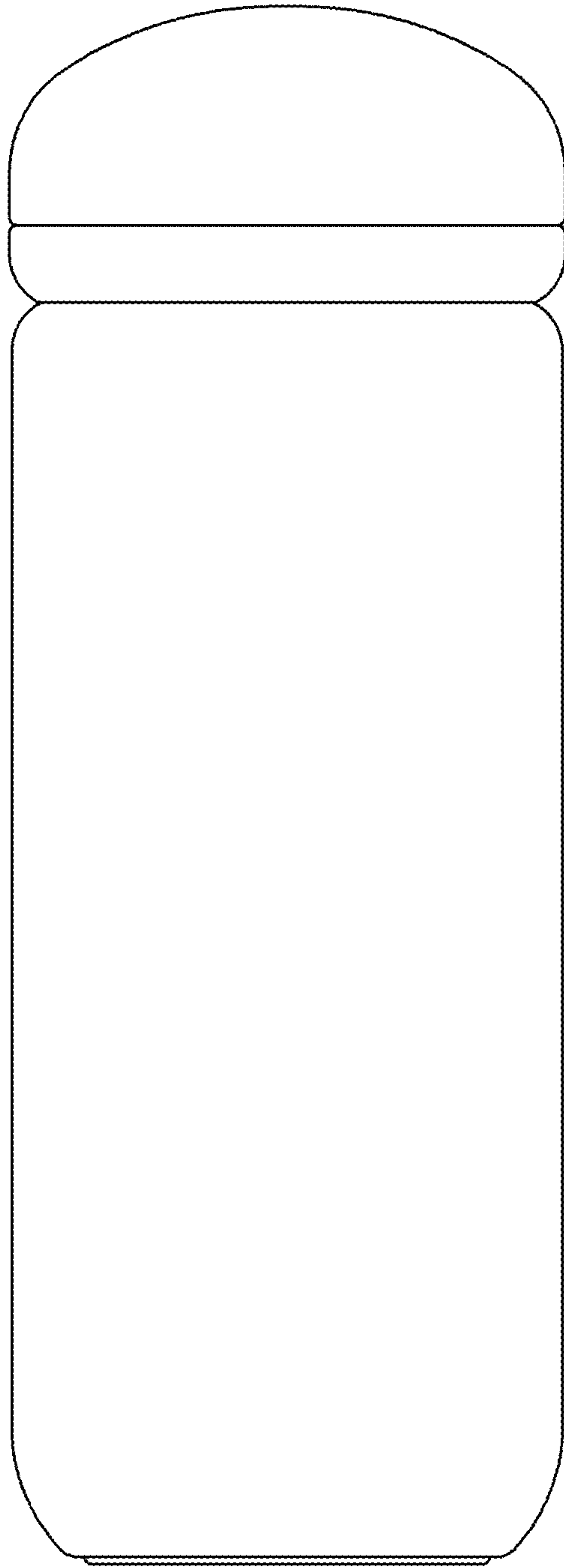

FIG.5

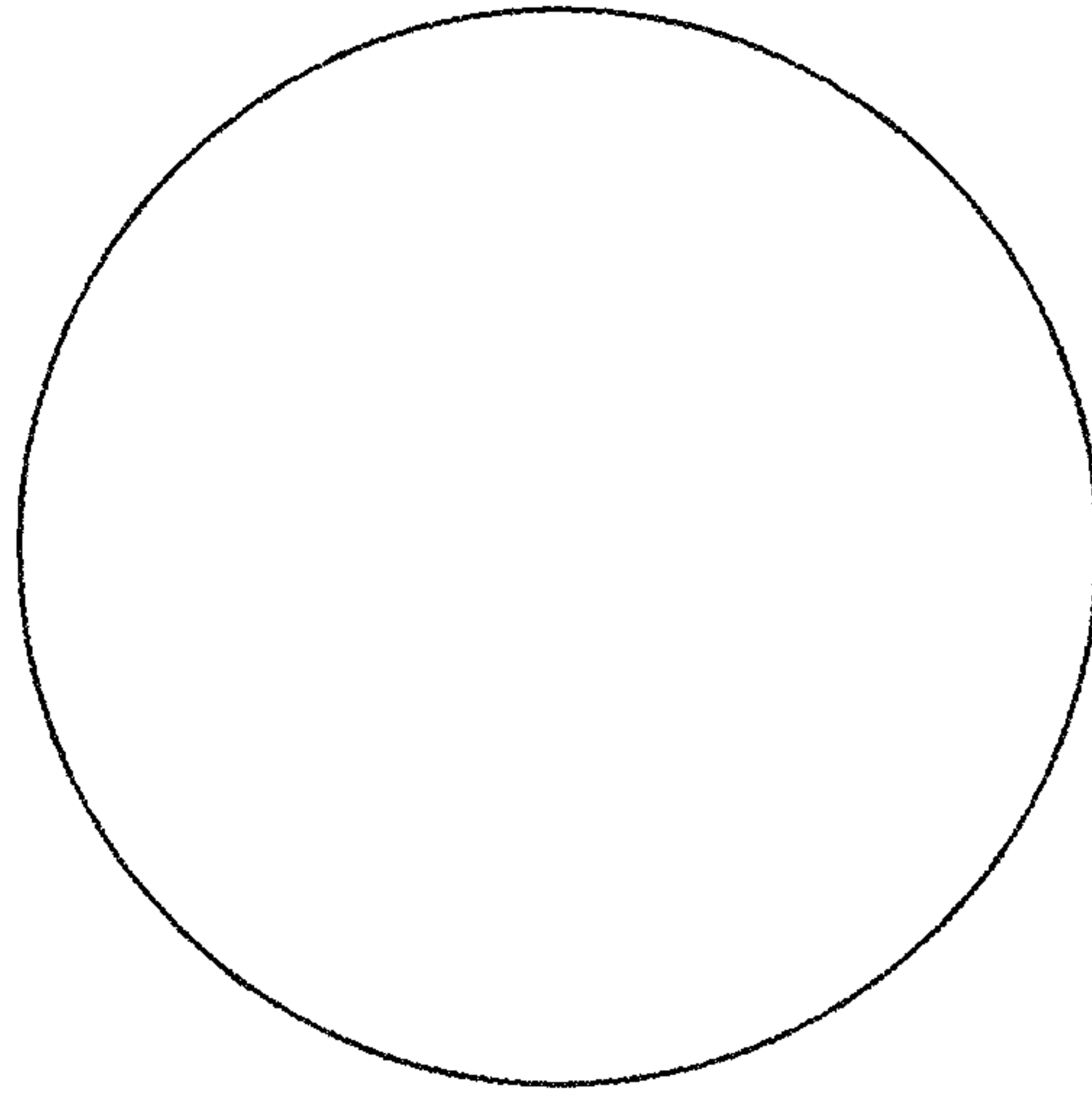

FIG.6

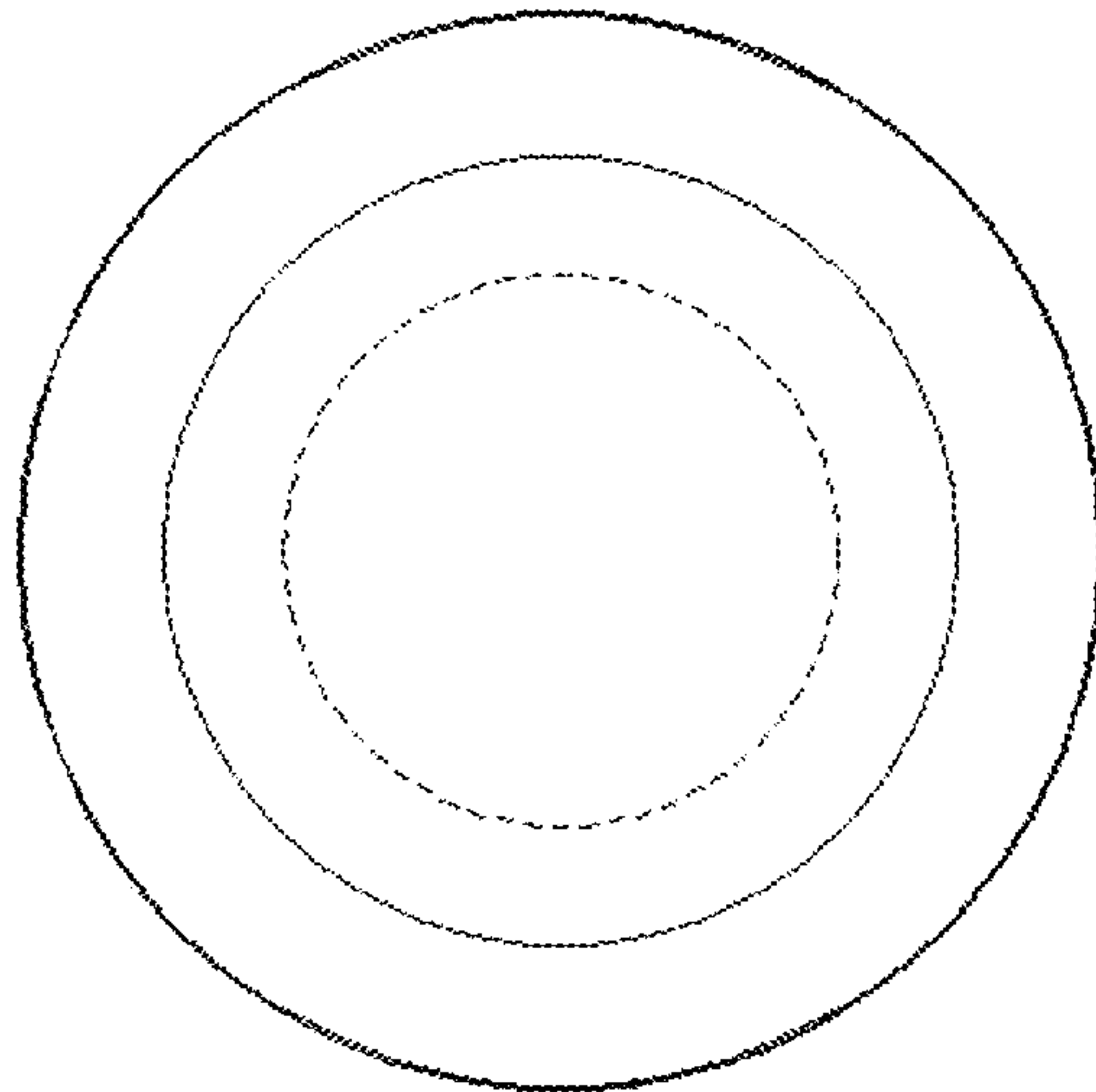

FIG.7

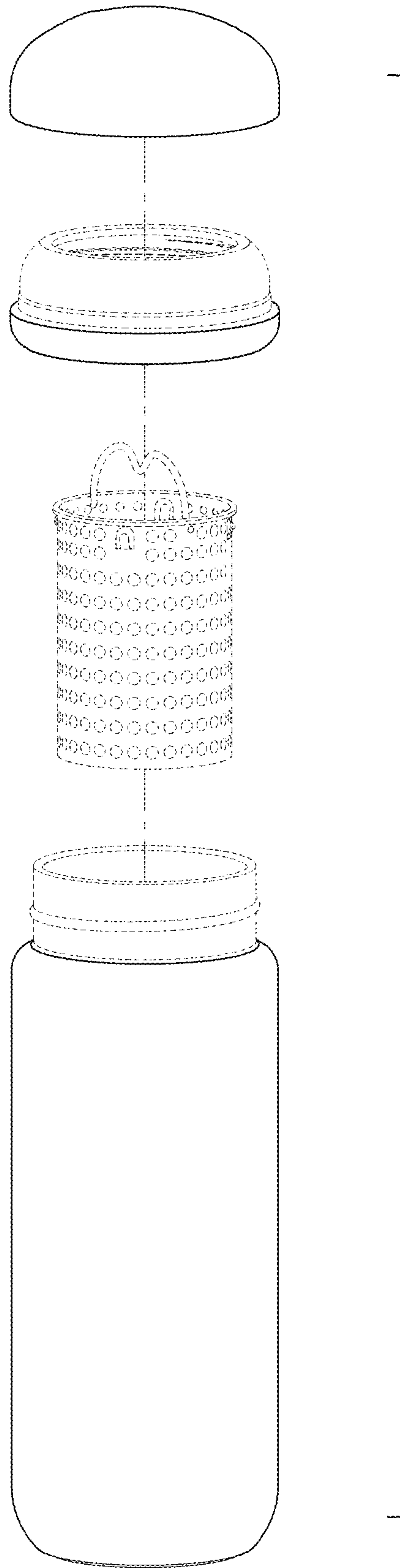

FIG. 8