



US00D907941S

(12) **United States Design Patent**
Chanfrau, IV

(10) **Patent No.:** **US D907,941 S**

(45) **Date of Patent:** **** Jan. 19, 2021**

(54) **MULTIPLE HEIGHT AND SLOPE PILLOW**

(71) Applicant: **Jose Manuel Chanfrau, IV**, Miramar,
FL (US)

(72) Inventor: **Jose Manuel Chanfrau, IV**, Miramar,
FL (US)

(**) Term: **15 Years**

(21) Appl. No.: **29/669,757**

(22) Filed: **Apr. 12, 2020**

(51) **LOC (13) Cl.** **06-09**

(52) **U.S. Cl.**
USPC **D6/601**

(58) **Field of Classification Search**
USPC D6/595-601, 604, 606; D24/183, 190;
D21/803, 809
CPC A47C 20/00; A47C 20/021; A47C 7/742;
A47C 7/021; A47D 15/001; A47D
15/008; A47G 9/00; A47G 9/10; B62J
1/26

See application file for complete search history.

(56) **References Cited**

U.S. PATENT DOCUMENTS

D398,181 S * 9/1998 Lange D6/596
D400,386 S * 11/1998 Keilhauer D6/601
6,360,387 B1 * 3/2002 Everhart A47C 20/027
5/490

D521,301 S * 5/2006 Dickson D6/601
D543,064 S * 5/2007 Hale D6/596
D642,412 S * 8/2011 Cuba D6/601
D753,312 S * 4/2016 Long D24/186
9,700,147 B2 * 7/2017 Kim Thi Pham A47C 9/005
D800,852 S * 10/2017 Flook D21/671
D805,325 S * 12/2017 Chan D6/601
D821,780 S * 7/2018 Strandberg D6/596
D864,612 S * 10/2019 Castellano D6/601
D882,296 S * 4/2020 Huang D6/601
2006/0027794 A1 * 2/2006 Heinz B32B 3/263
254/88

* cited by examiner

Primary Examiner — Jennifer L Rempfer

(57) **CLAIM**

The ornamental design for a multiple height and slope pillow, as shown and described.

DESCRIPTION

FIG. 1 shows a perspective top view of the multiple height and slope pillow;
FIG. 2 shows a top view thereof;
FIG. 3 shows a back view thereof;
FIG. 4 shows a side view thereof;
FIG. 5 shows a side view thereof;
FIG. 6 shows a top view thereof; and,
FIG. 7 shows a bottom view thereof.

1 Claim, 7 Drawing Sheets

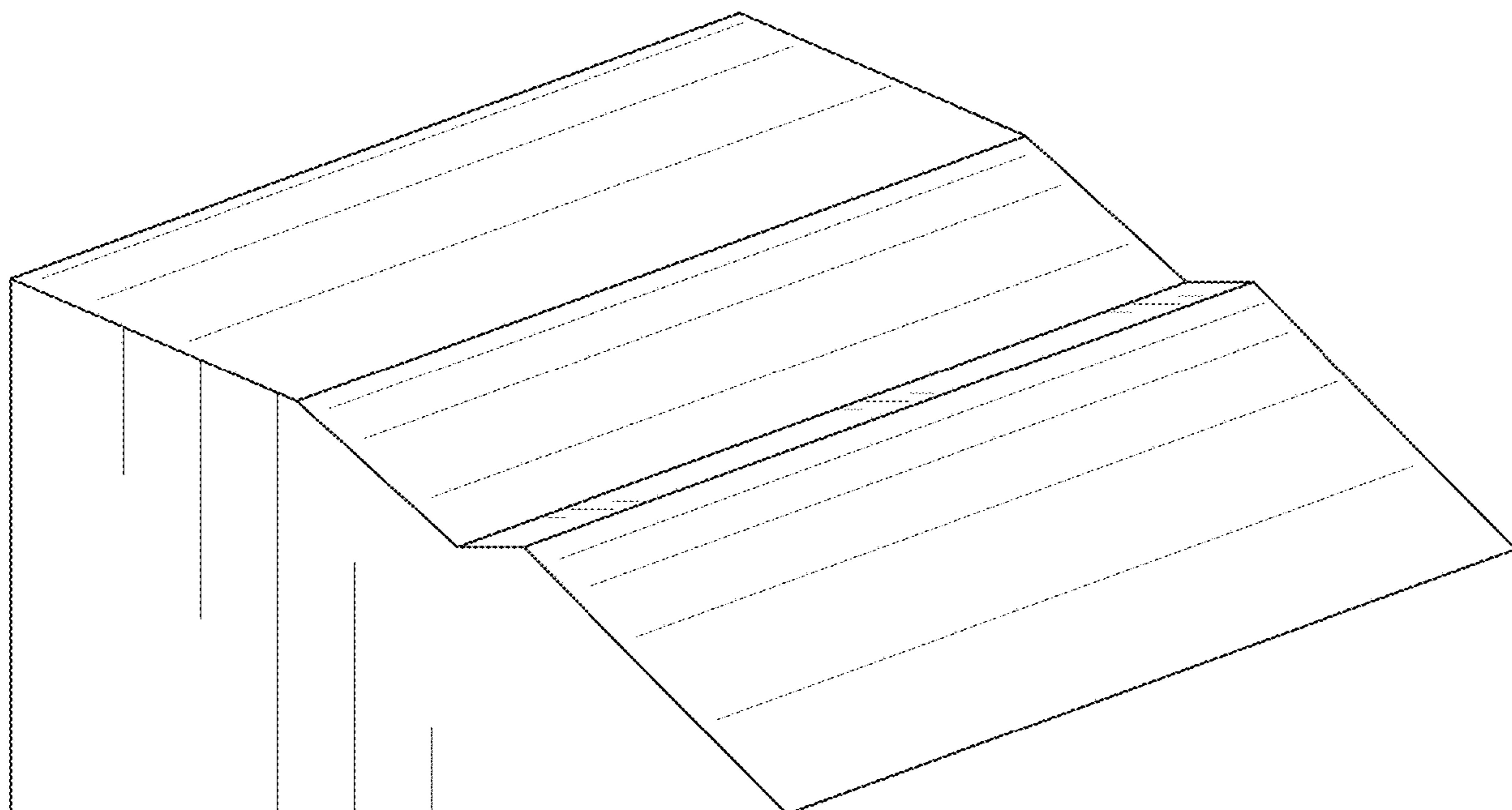

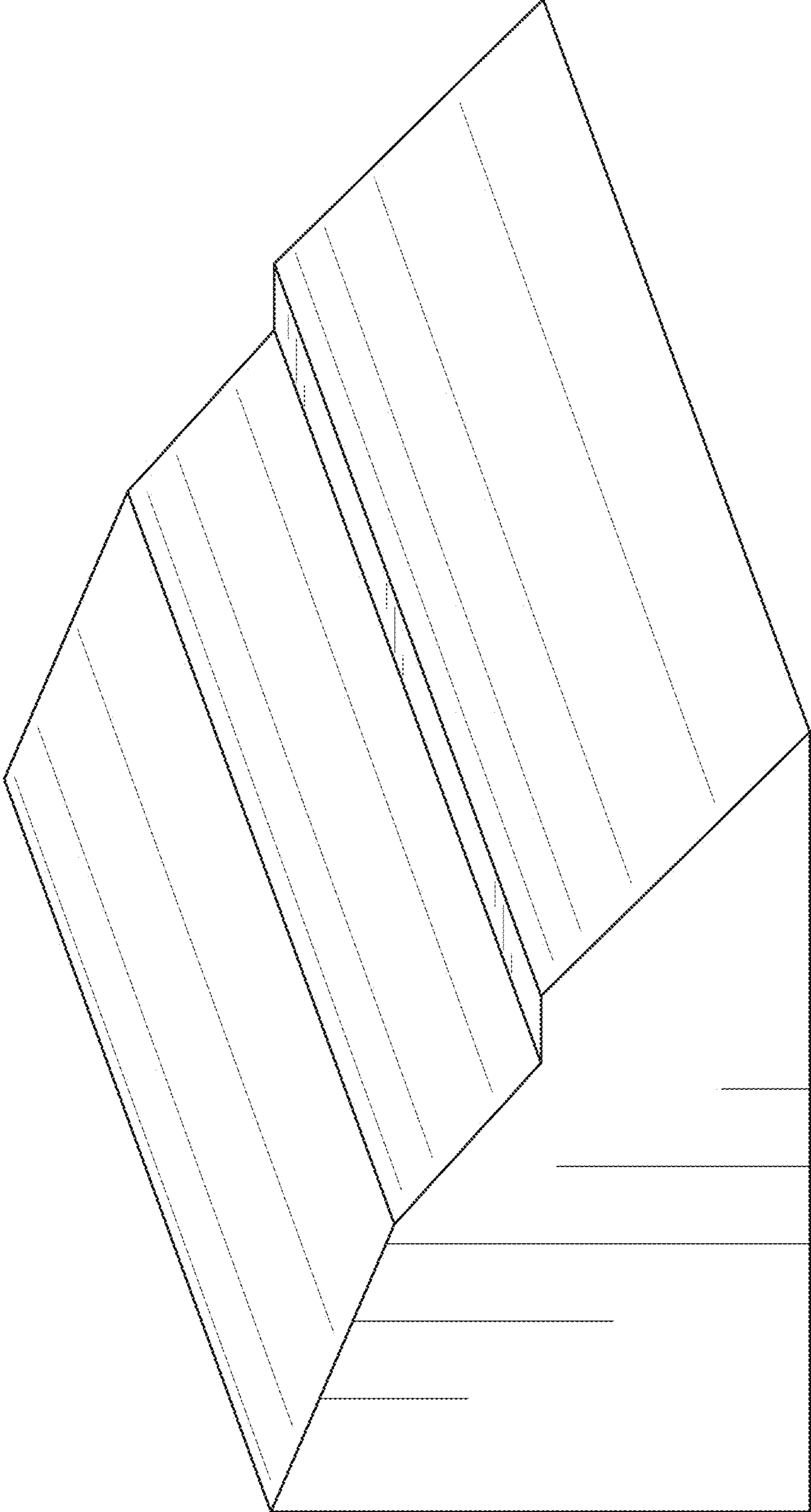

FIG. 1

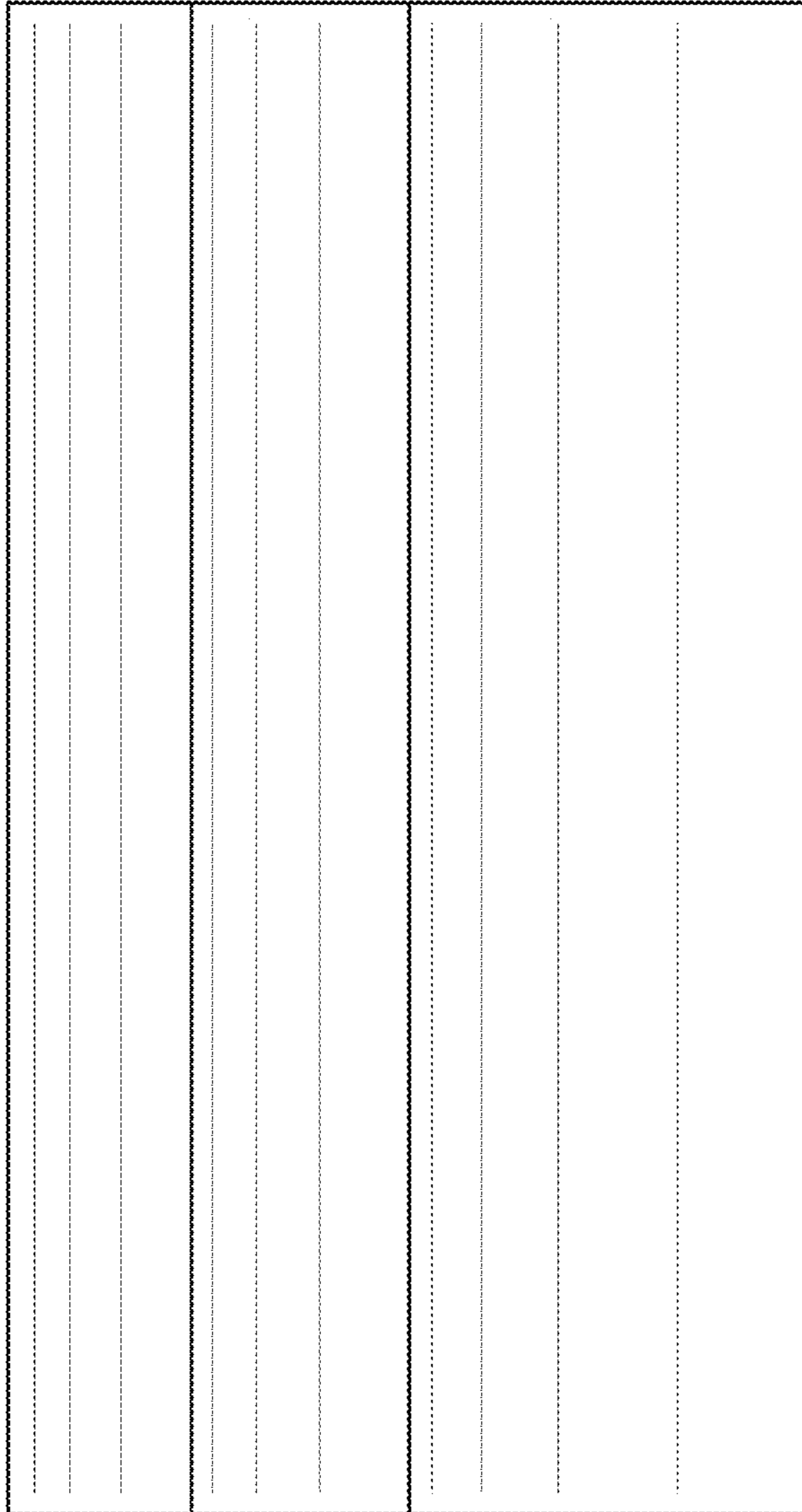

FIG. 2

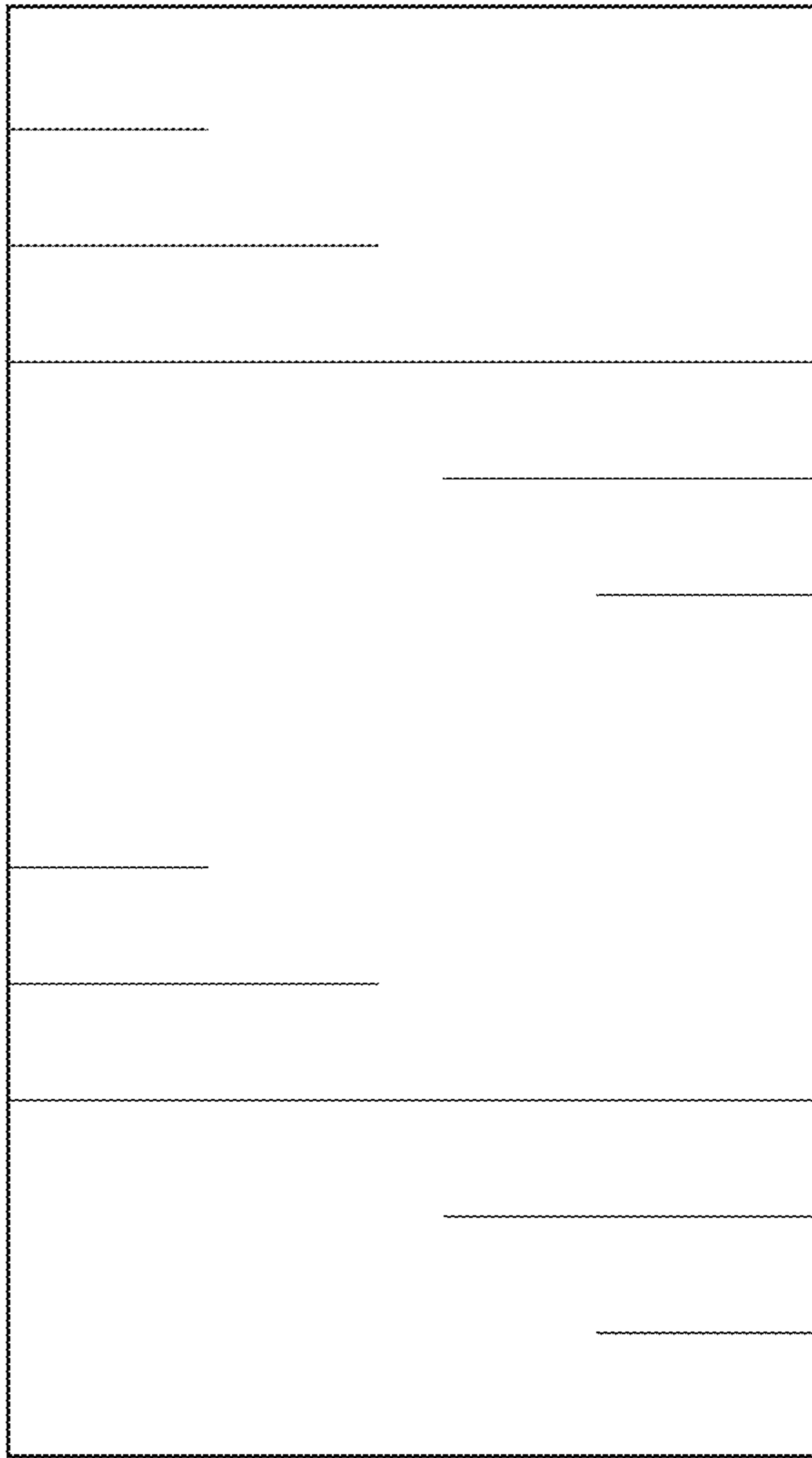

FIG. 3

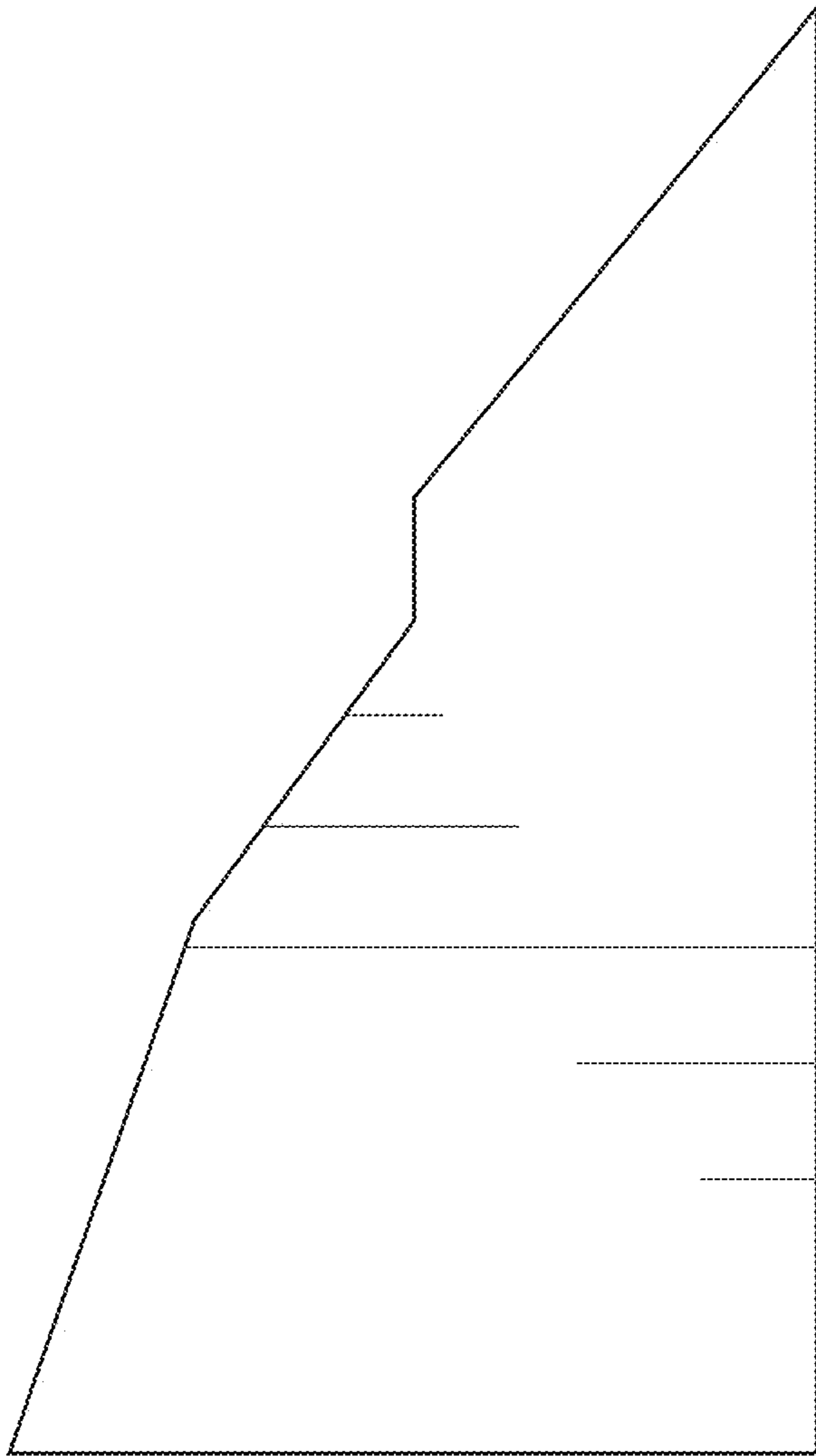

FIG. 4

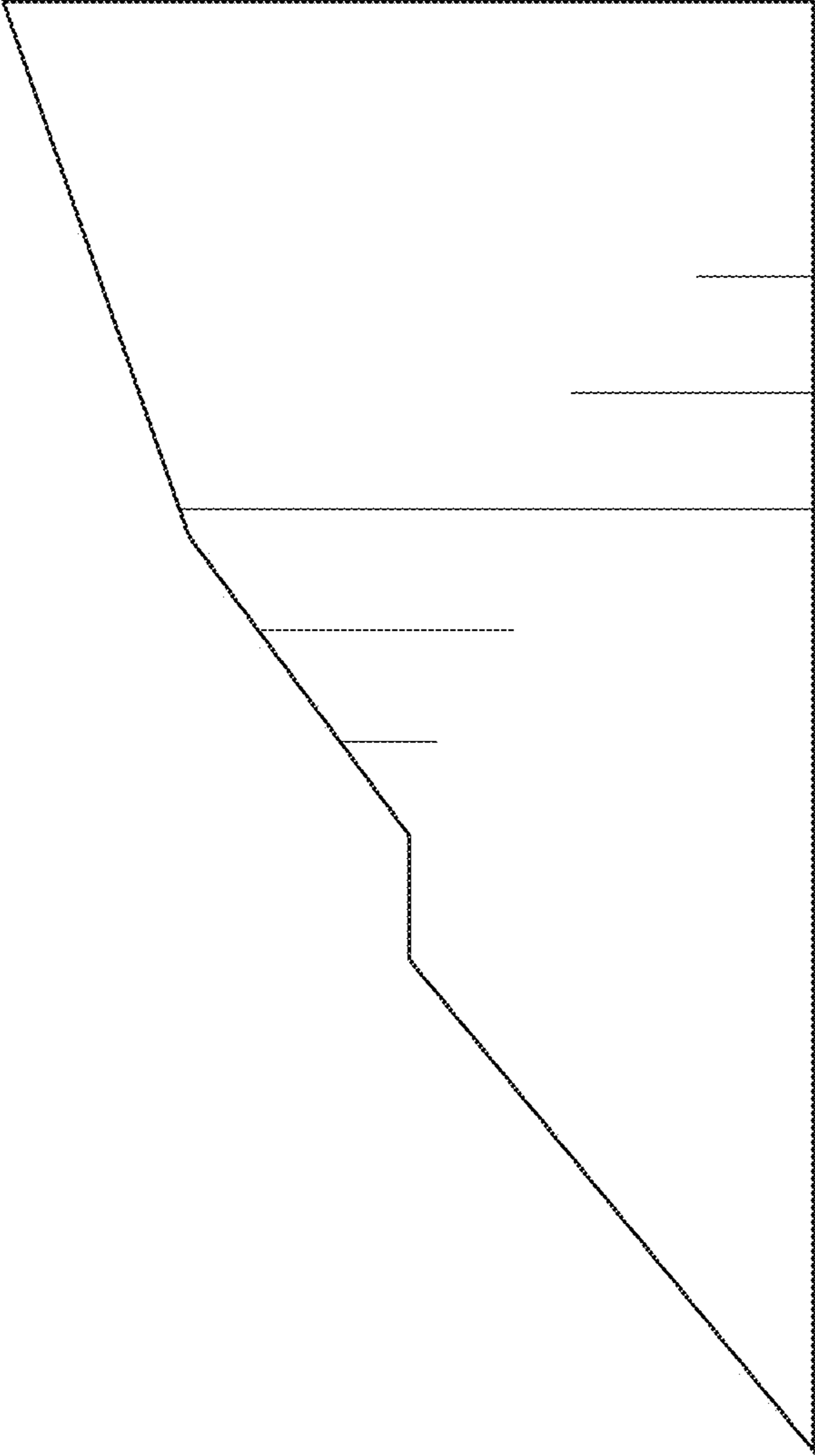

FIG. 5

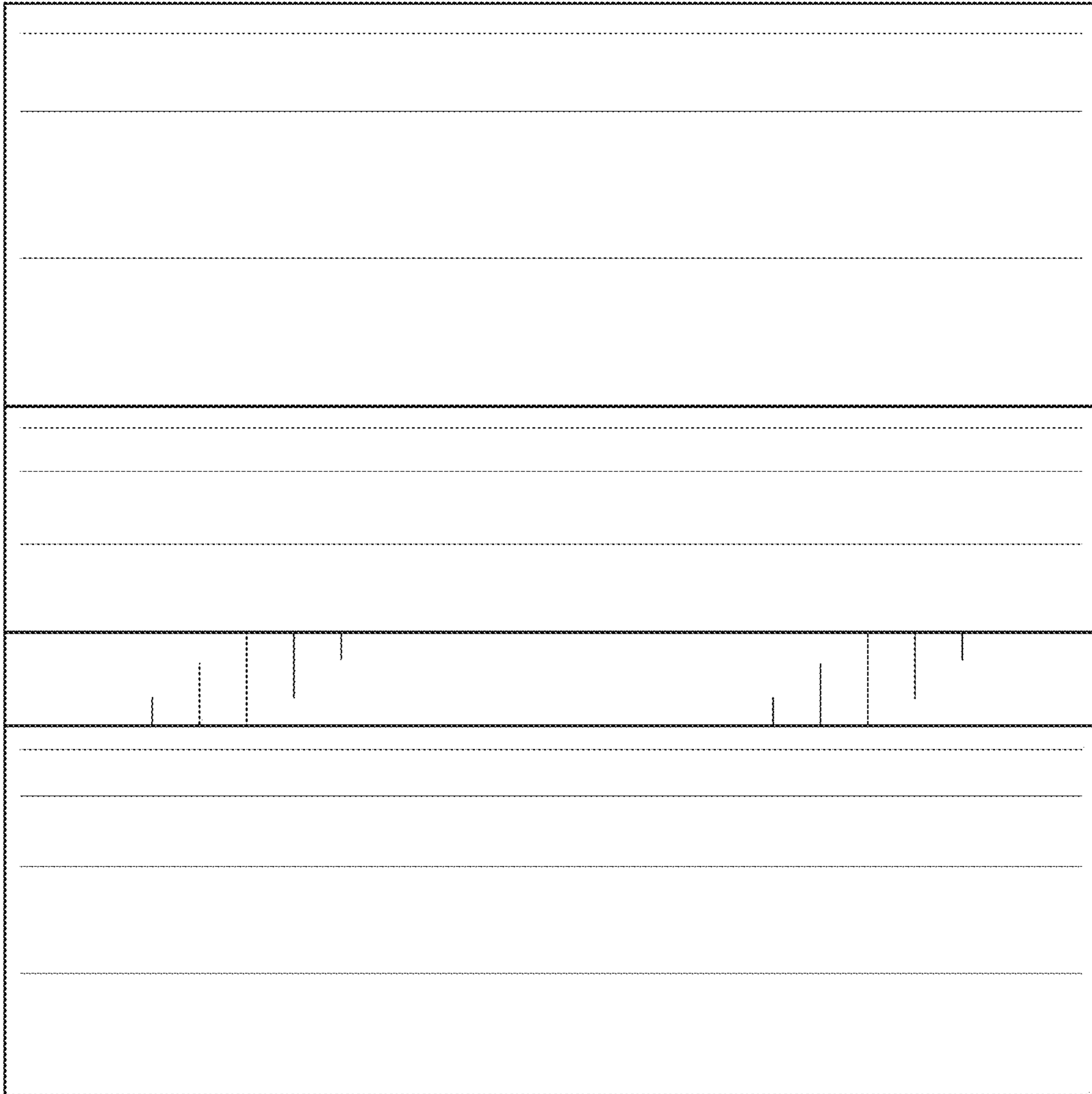

FIG. 6

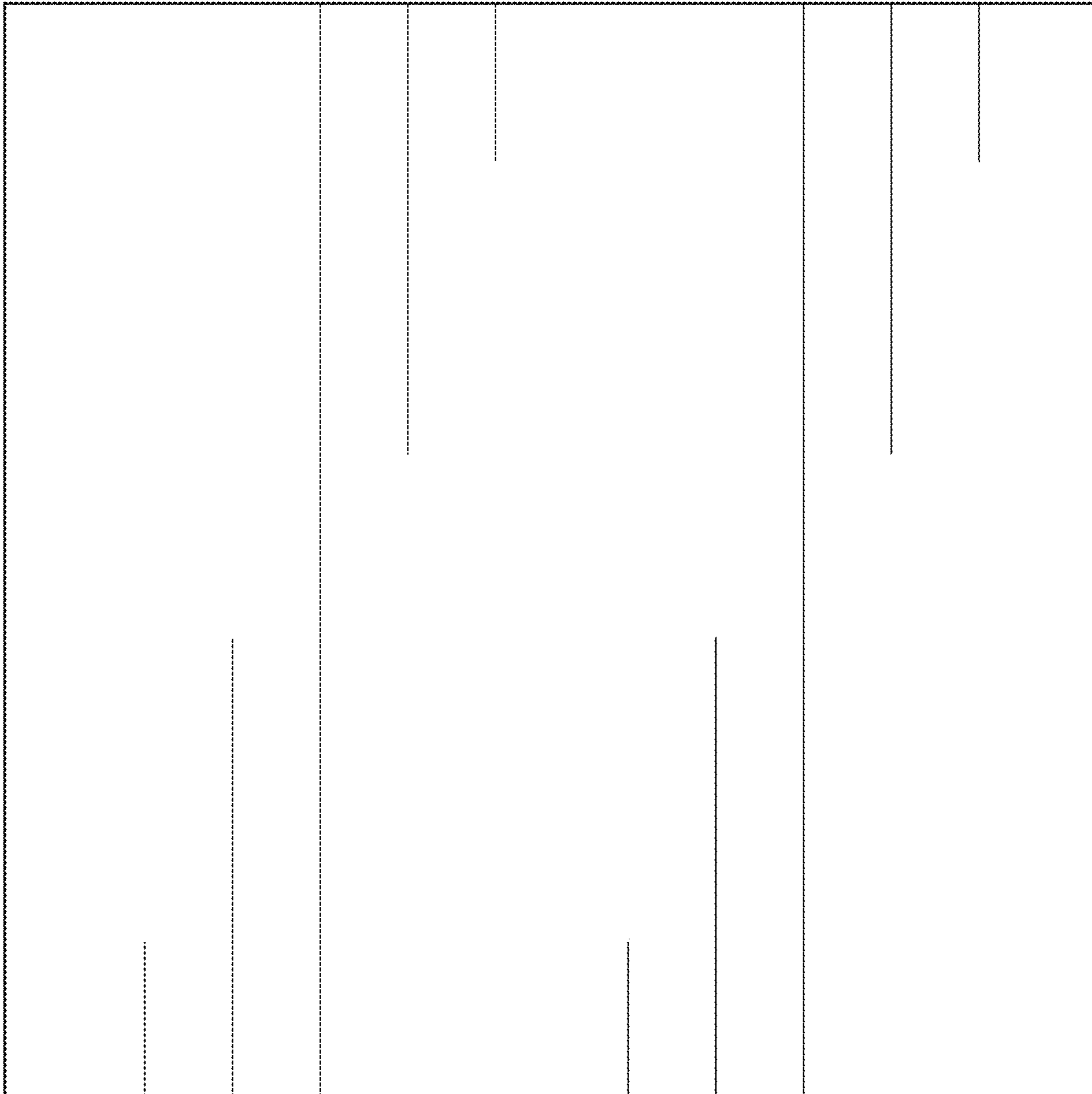

FIG. 7