



US00D907809S

(12) **United States Design Patent**
Burke

(10) **Patent No.:** **US D907,809 S**
(45) **Date of Patent:** **** Jan. 12, 2021**

(54) **SKYLIGHT GUARD**

(71) Applicant: **HIPPO INC. LLC**, Colorado Springs,
CO (US)

(72) Inventor: **David Shane Burke**, Colorado Springs,
CO (US)

(73) Assignee: **HIPPO Inc.**, Colorado Springs, CO
(US)

(**) Term: **15 Years**

(21) Appl. No.: **29/696,297**

(22) Filed: **Jun. 26, 2019**

(51) **LOC (13) Cl.** **25-02**

(52) **U.S. Cl.**
USPC **D25/48.8**

(58) **Field of Classification Search**
USPC D25/47.1, 48.1, 48.7, 48.8
CPC E04D 13/0335; E04D 3/32; F24F 13/08
See application file for complete search history.

(56) **References Cited**

U.S. PATENT DOCUMENTS

1,112,401	A *	9/1914	Allen	E04D 13/0335
					49/356
1,236,008	A *	8/1917	Rysdon	E04D 13/0335
					52/200
1,742,613	A *	1/1930	Moore	F24F 13/08
					454/331
5,179,992	A *	1/1993	Okarski	E04D 13/033
					160/327
5,419,090	A *	5/1995	Sadow	E04D 3/32
					52/200
6,009,929	A *	1/2000	Linderman	E04D 13/033
					160/104
D518,577	S *	4/2006	Bunting	D25/48.8

(Continued)

FOREIGN PATENT DOCUMENTS

EM 000094149-0001 * 2/2004

OTHER PUBLICATIONS

Skylight guards <https://skylight-guards.com/> Apr. 2019 (Year: 2019).*
(Continued)

Primary Examiner — Leanne Was-Englehart
(74) *Attorney, Agent, or Firm* — Martensen IP

(57) **CLAIM**

The ornamental design for a skylight guard, as shown and described.

DESCRIPTION

FIG. 1 is a front, top perspective drawing of one embodiment of a skylight guard showing our new design;
 FIG. 2 is a front view thereof;
 FIG. 3 is a back view thereof;
 FIG. 4 is a right side view thereof;
 FIG. 5 is a left side view thereof;
 FIG. 6 is a top view thereof;
 FIG. 7 is a bottom view thereof;
 FIG. 8 is a front, top perspective view of a second embodiment thereof;
 FIG. 9 is a front view thereof;
 FIG. 10 is a back view thereof;
 FIG. 11 is a right side view thereof;
 FIG. 12 is a left side view thereof;
 FIG. 13 is a top view thereof;
 FIG. 14 is a bottom view thereof;
 FIG. 15 is a front, top perspective view of a third embodiment thereof;
 FIG. 16 is a front view thereof;
 FIG. 17 is a back view thereof;
 FIG. 18 is a right side view thereof;
 FIG. 19 is a left side view thereof;
 FIG. 20 is a top view thereof; and,
 FIG. 21 is a bottom view thereof.

1 Claim, 18 Drawing Sheets

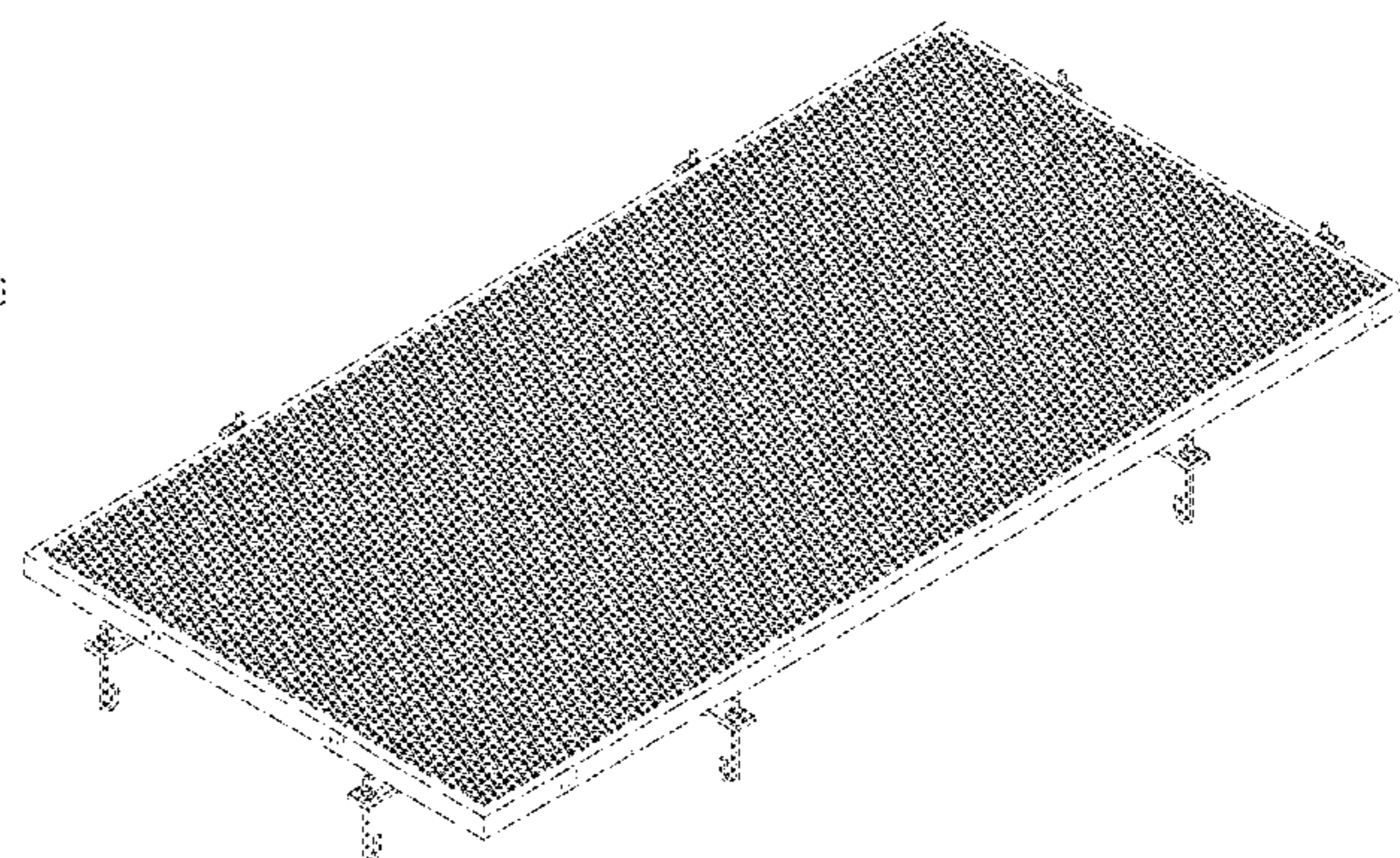
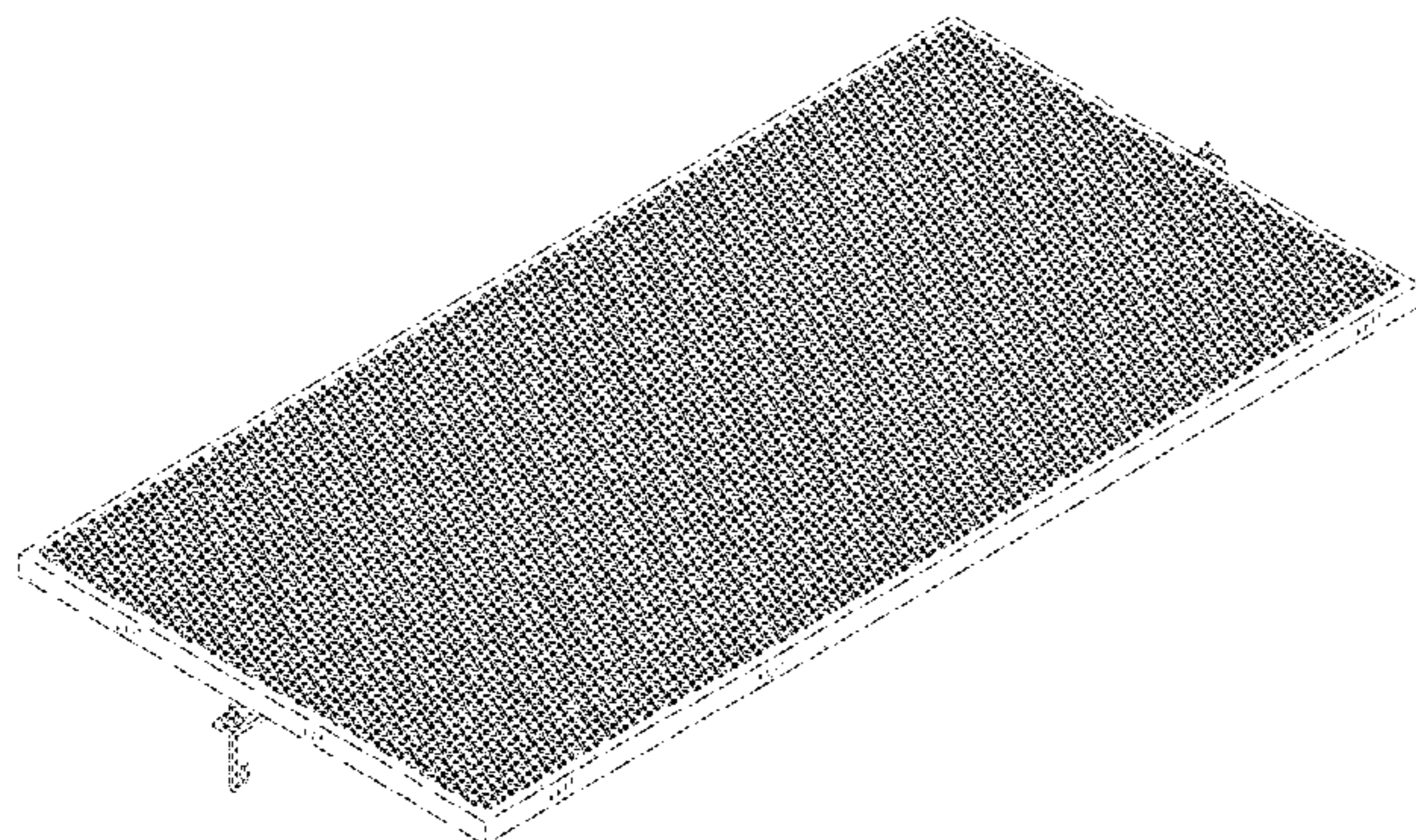

(56)

References Cited

U.S. PATENT DOCUMENTS

D634,413 S * 3/2011 Wallace D23/354
8,782,973 B1 * 7/2014 Everingham E04D 13/0335
52/200
8,911,286 B1 * 12/2014 Savigny F24F 7/00
454/248
D892,279 S * 8/2020 Ealer, Sr. D23/267

OTHER PUBLICATIONS

Skylight Guard YouTube <https://www.youtube.com/watch?v=52rWed-Dkaw> Posted Feb. 22, 2011 (Year: 2011).*

* cited by examiner

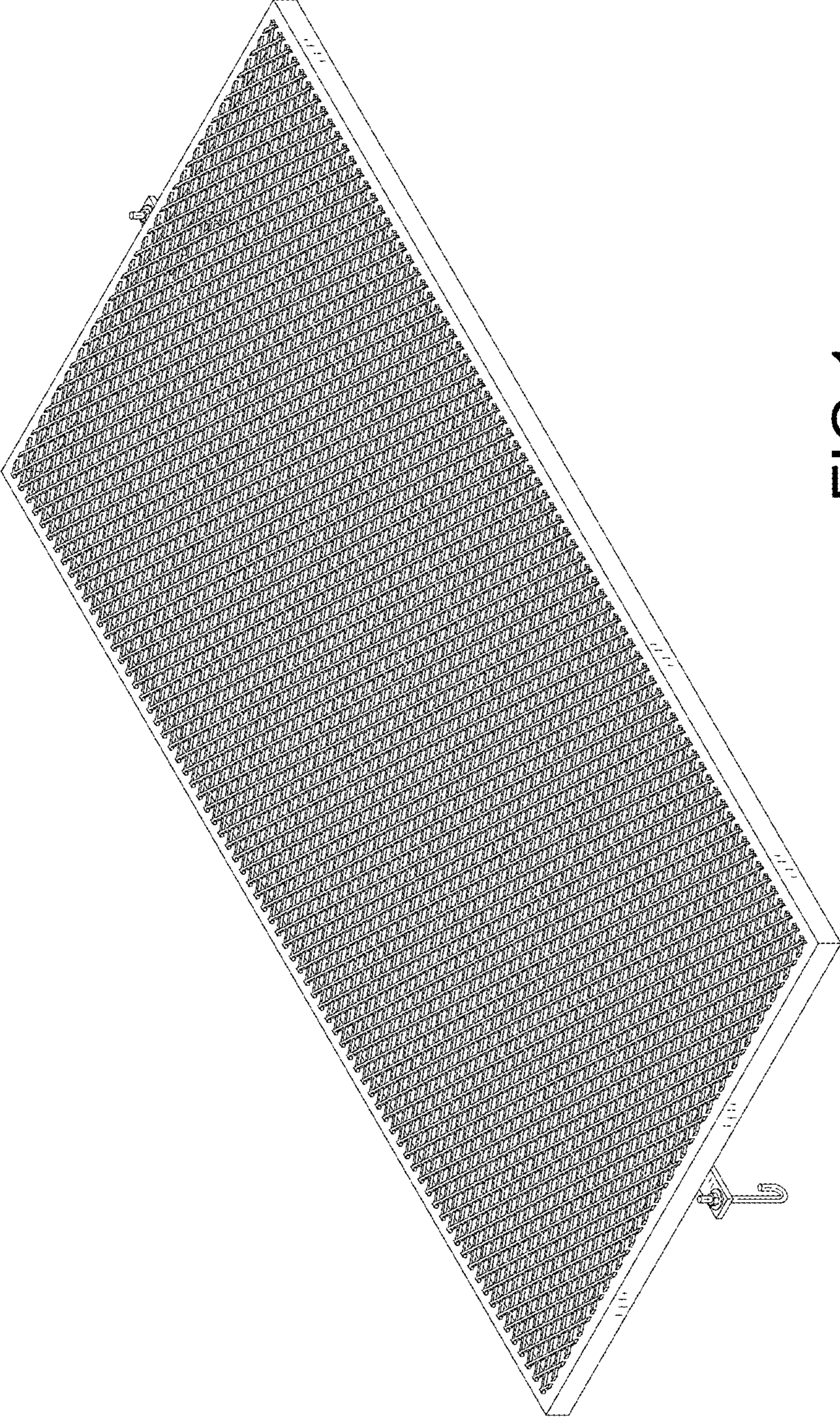

FIG.1

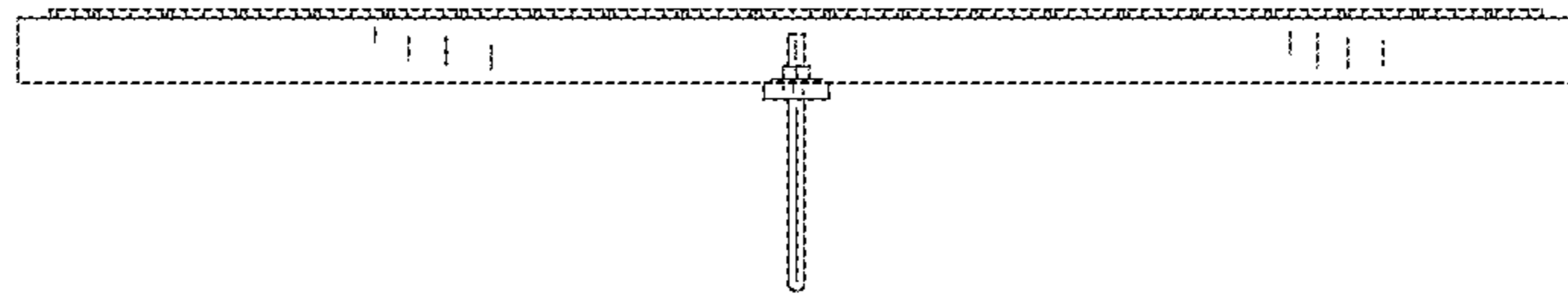

FIG. 2

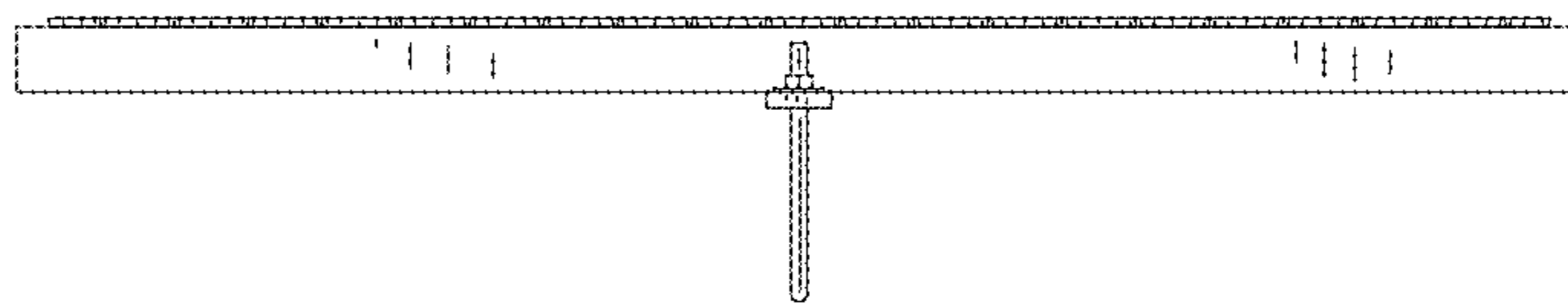

FIG. 3

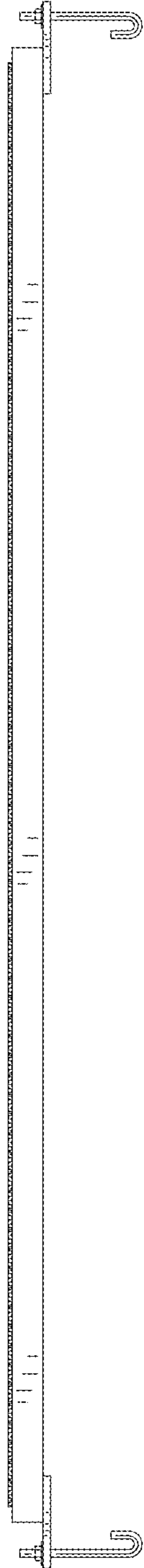

FIG.4

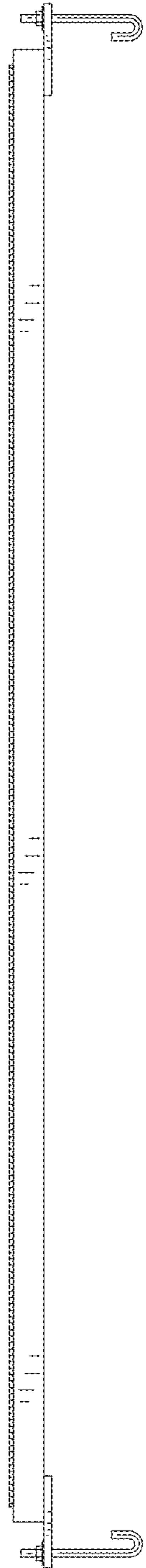

FIG.5

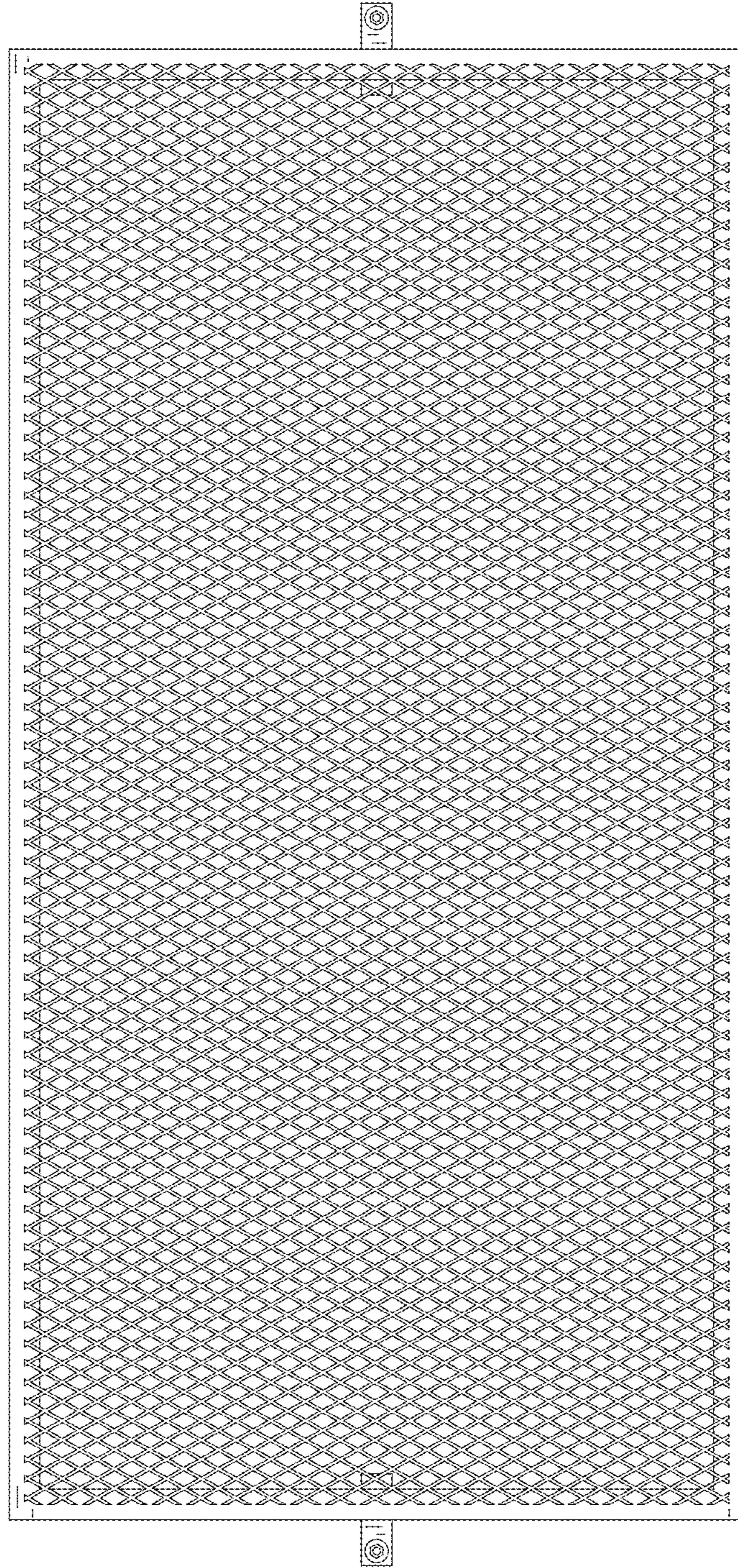

FIG.6

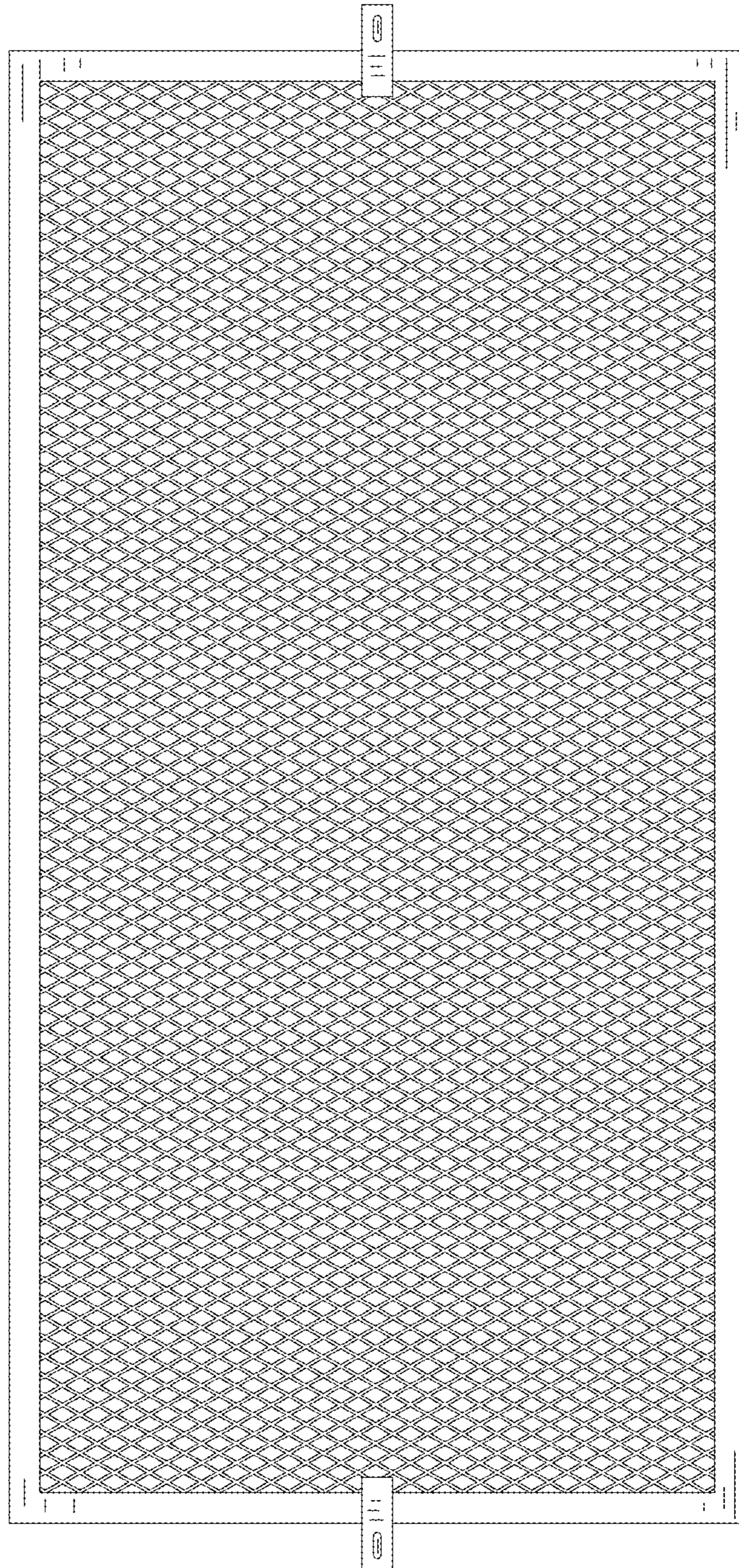

FIG.7

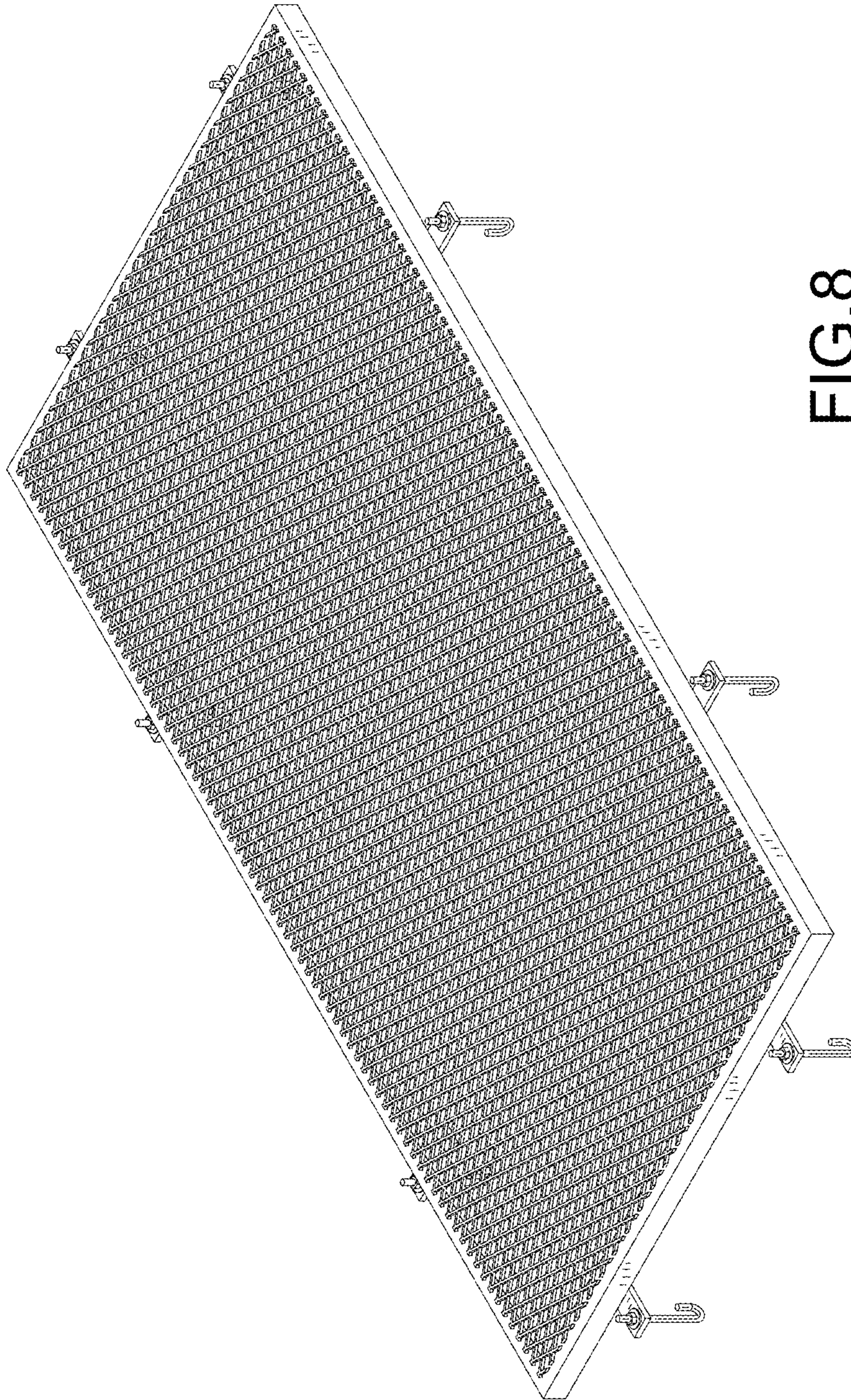

FIG.8

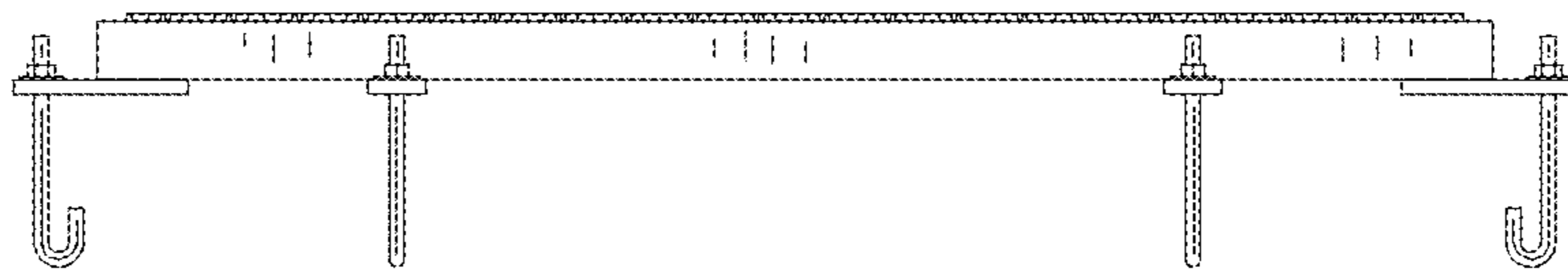

FIG. 9

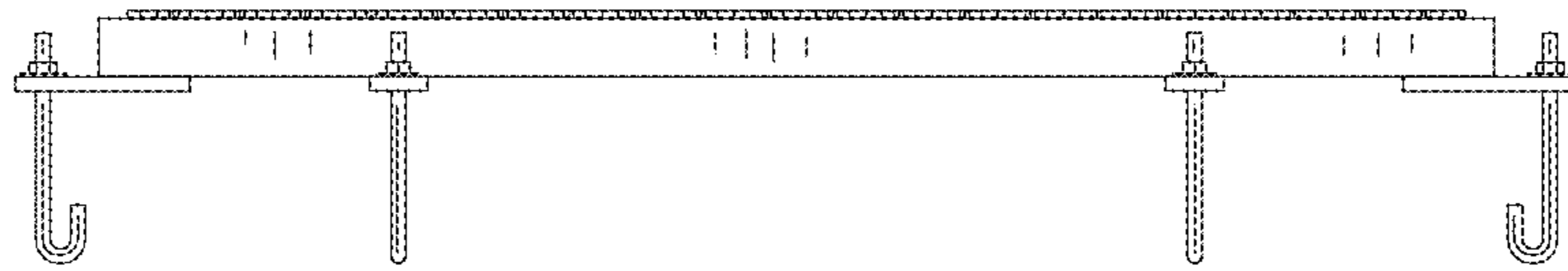

FIG. 10

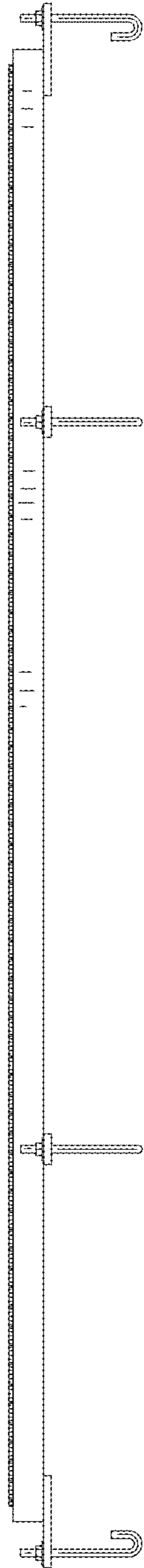

FIG.11

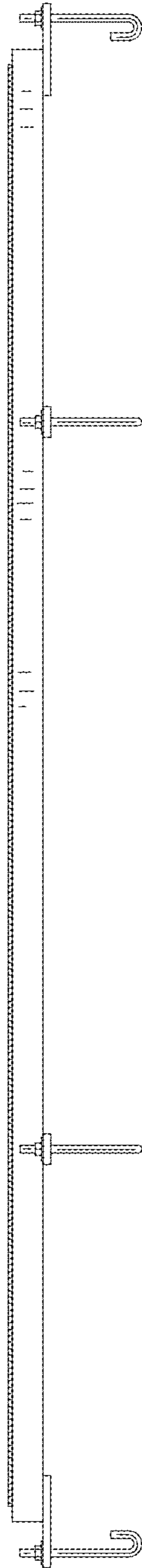

FIG.12

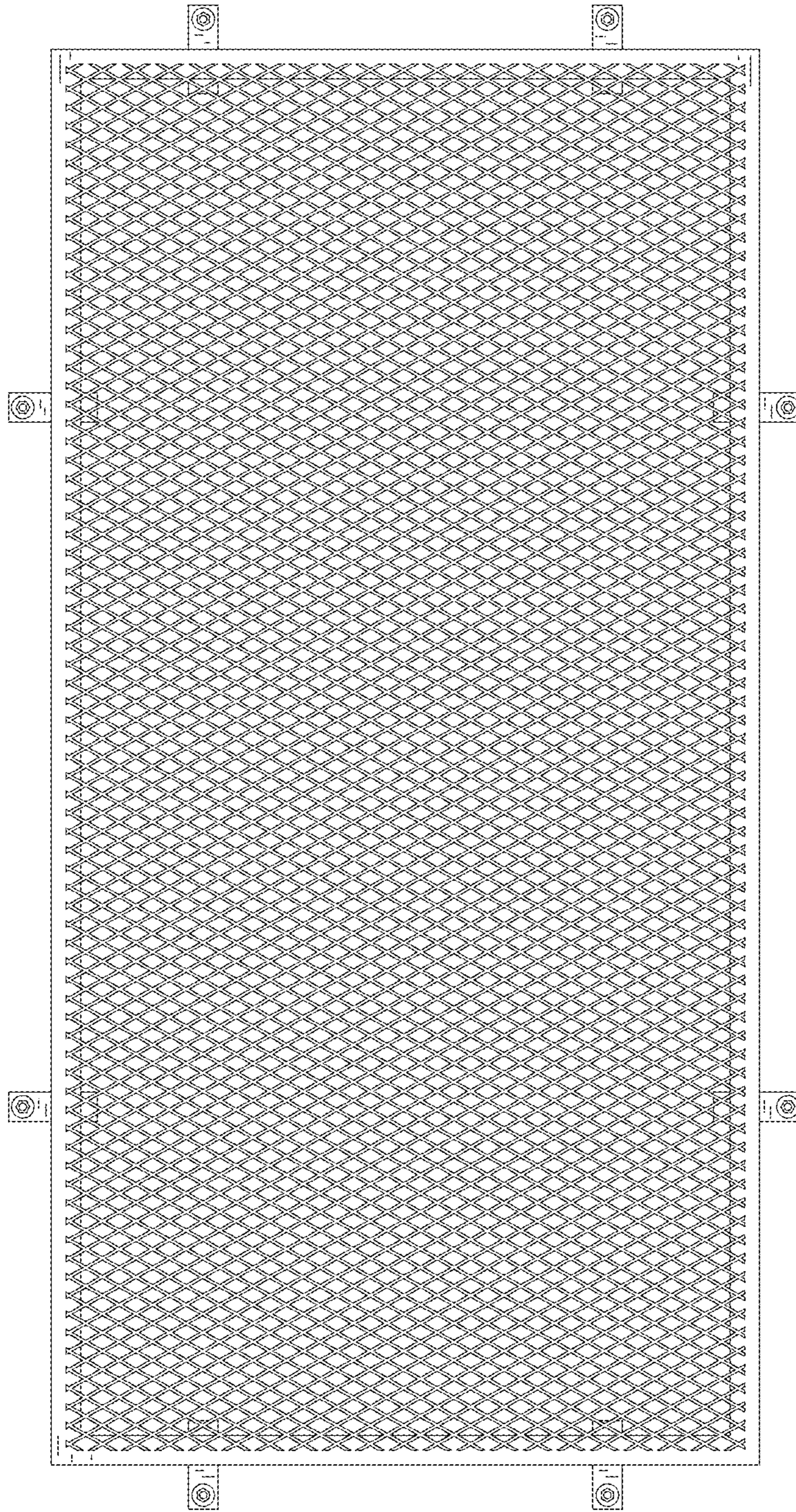

FIG.13

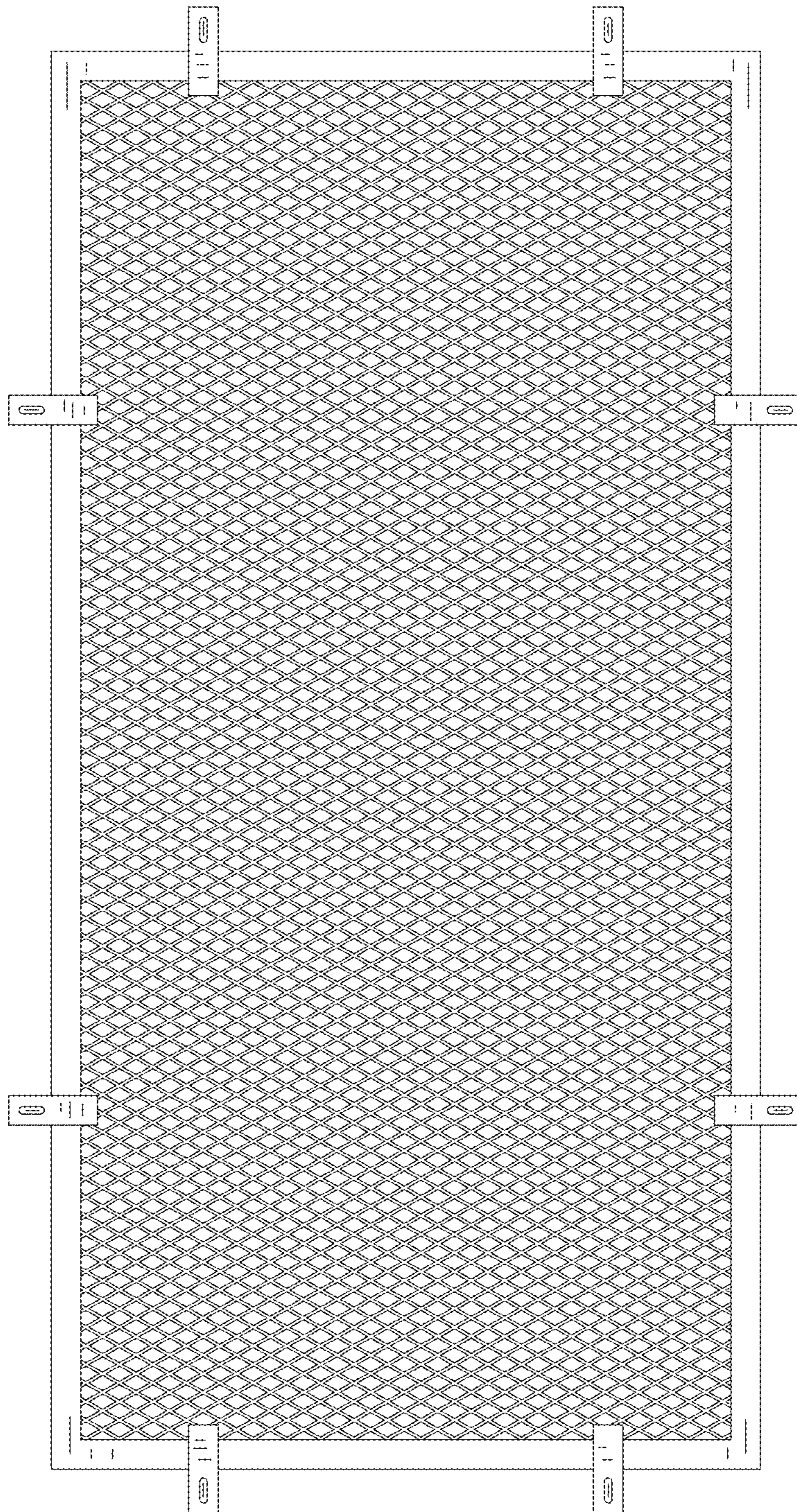

FIG.14

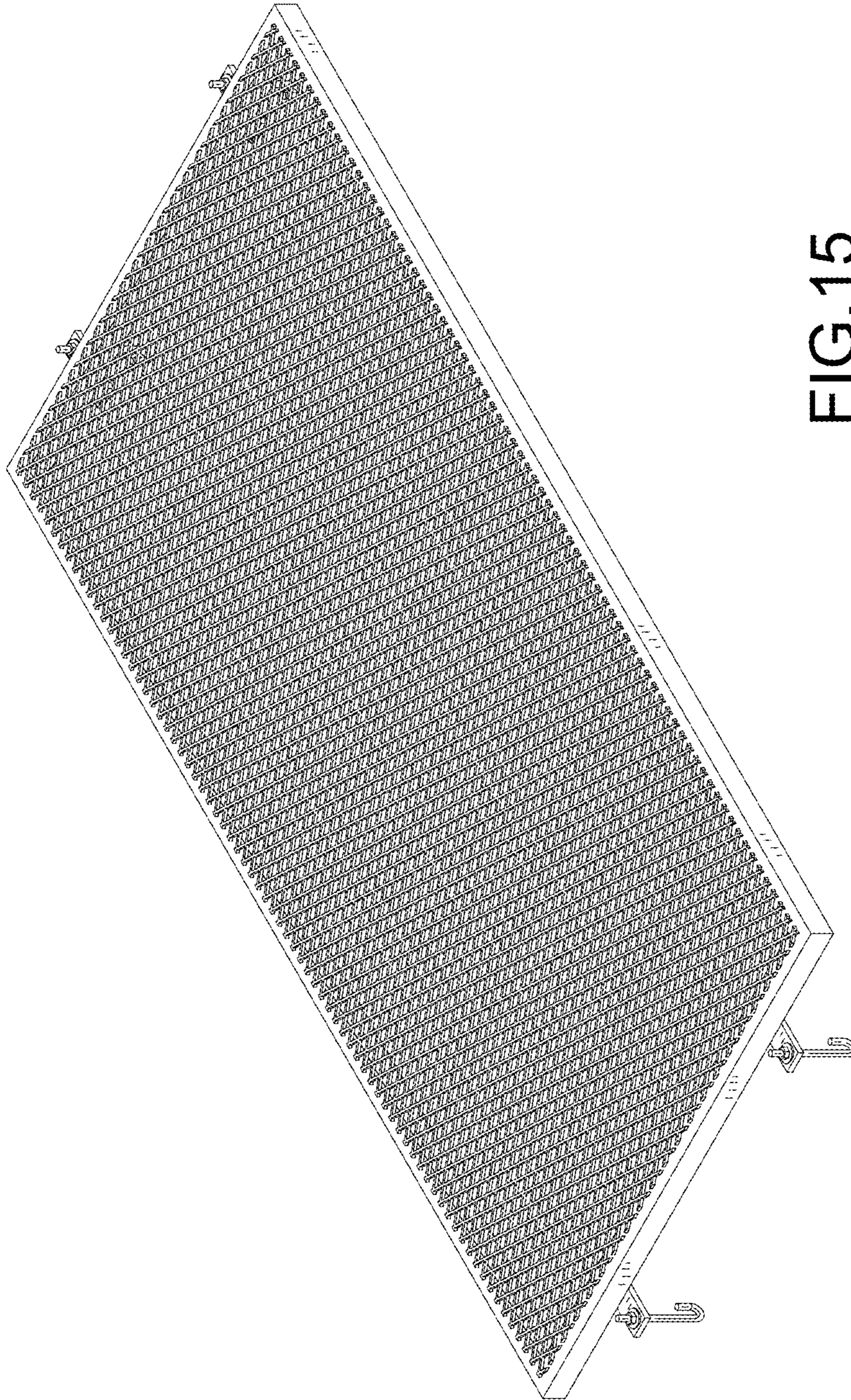

FIG.15

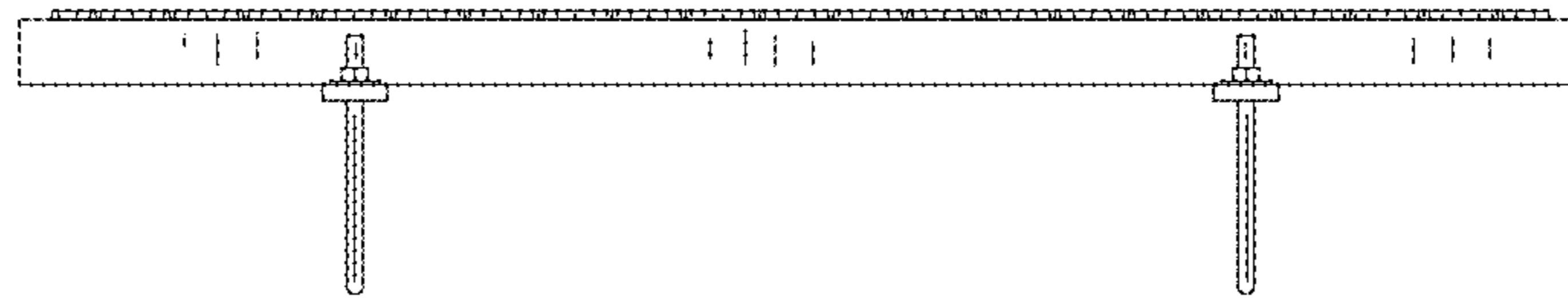

FIG.16

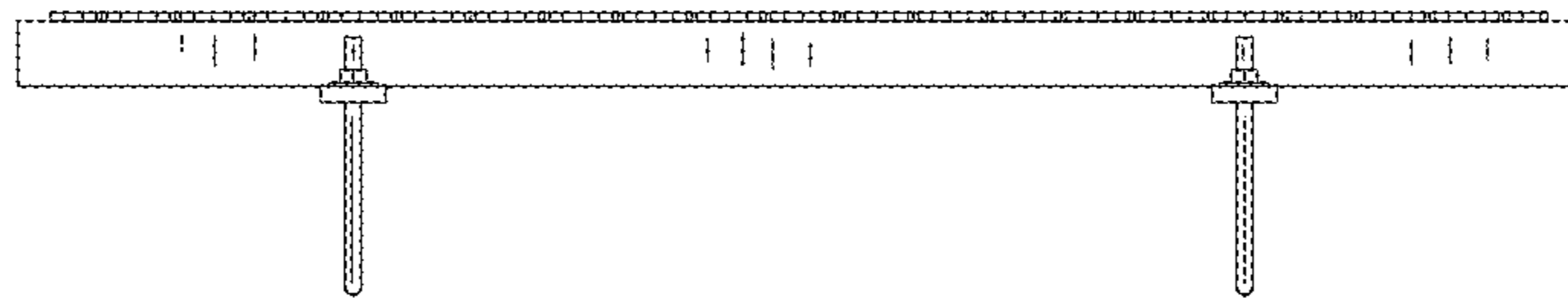

FIG.17

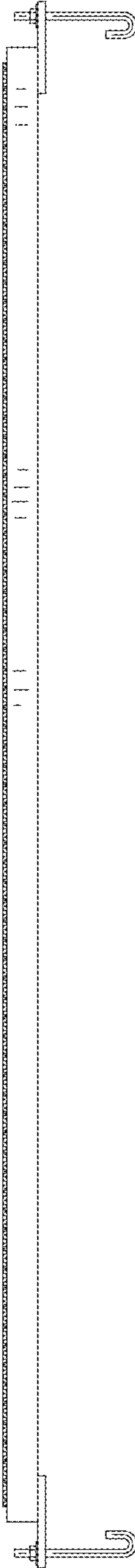

FIG.18

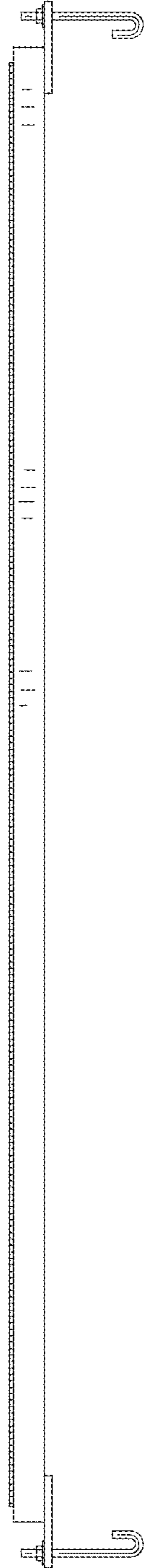

FIG.19

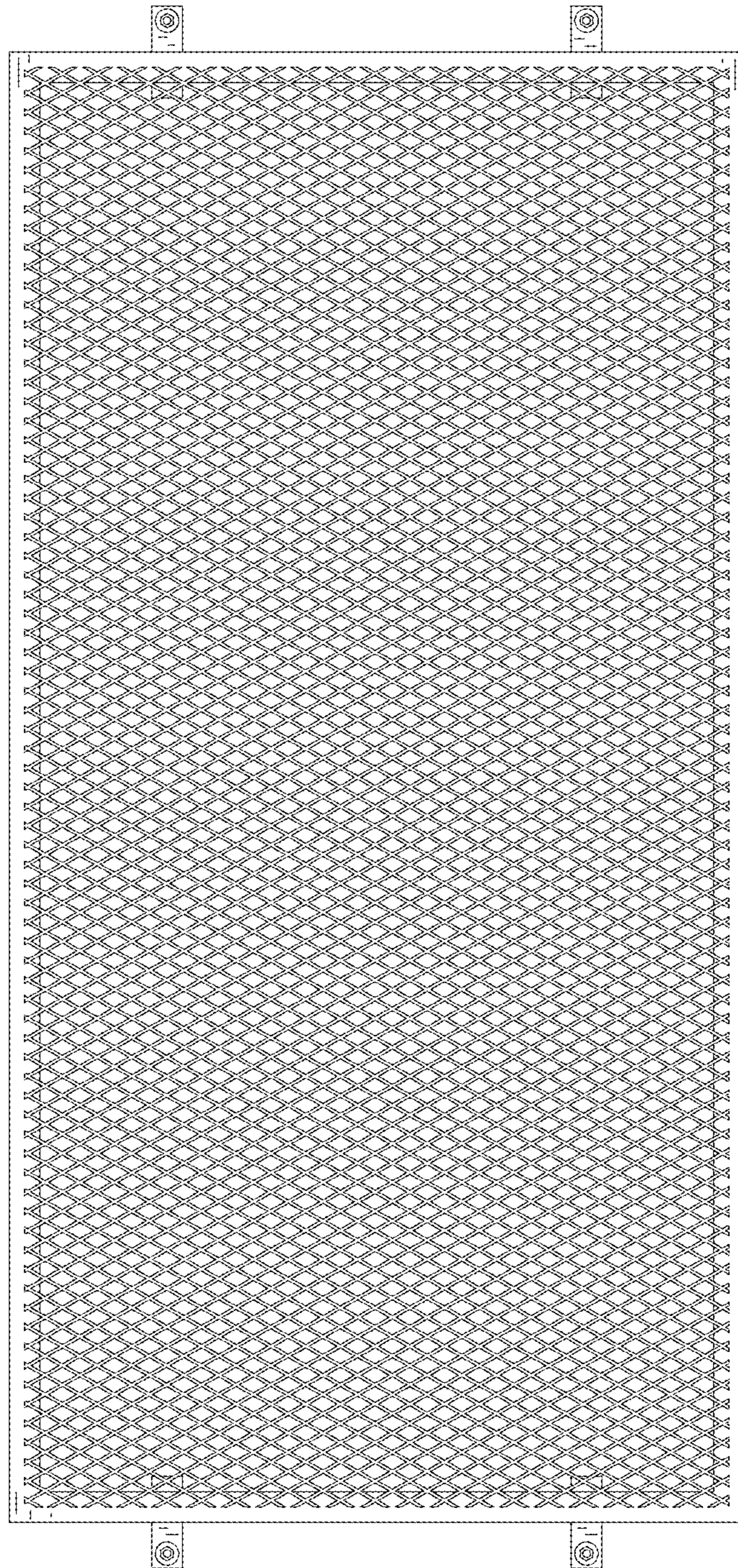

FIG.20

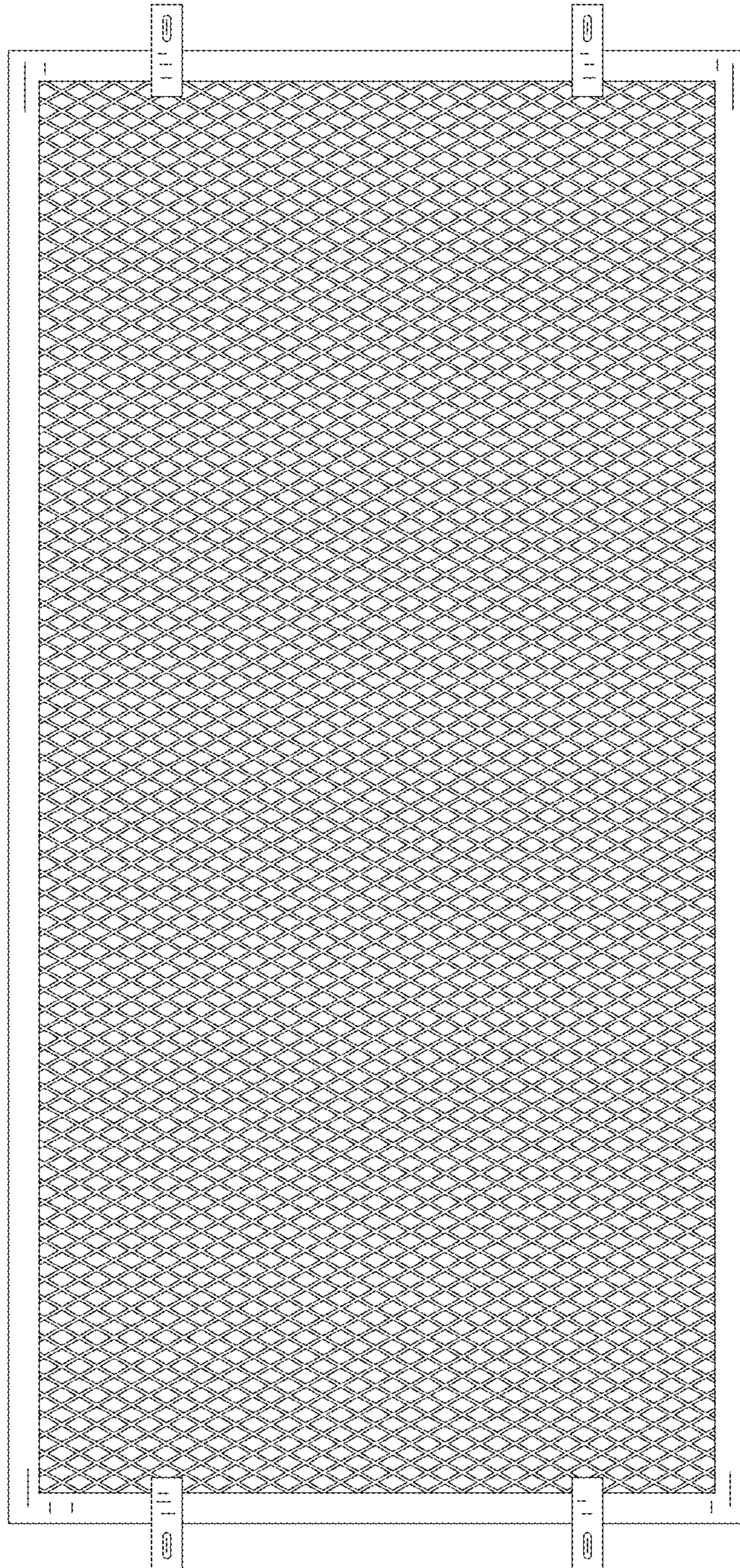

FIG.21