



US00D907791S

(12) **United States Design Patent** (10) **Patent No.:** **US D907,791 S**
Ackermann et al. (45) **Date of Patent:** **** Jan. 12, 2021**

- (54) **NASAL STIMULATOR BODY**
- (71) Applicant: **Oculeve, Inc.**, South San Francisco, CA (US)
- (72) Inventors: **Douglas Michael Ackermann**, San Francisco, CA (US); **James Donald Loudin**, Houston, TX (US); **John Wardle**, San Clemente, CA (US); **John W. Lai**, San Bruno, CA (US); **Natalie Catherine Vanns**, Hildenborough (GB)
- (73) Assignee: **Oculeve, Inc.**, South San Francisco, CA (US)
- (**) Term: **15 Years**
- (21) Appl. No.: **29/666,268**
- (22) Filed: **Oct. 11, 2018**

Related U.S. Application Data

- (60) Continuation of application No. 29/562,792, filed on Apr. 28, 2016, now Pat. No. Des. 837,396, which is a division of application No. 29/488,488, filed on Apr. 18, 2014, now abandoned.
- (51) **LOC (13) Cl.** **28-03**
- (52) **U.S. Cl.**
USPC **D24/215**
- (58) **Field of Classification Search**
USPC D24/200, 211, 212, 213, 214, 215
CPC A61N 1/3606; A61N 1/37205; A61F 5/08
See application file for complete search history.

References Cited

U.S. PATENT DOCUMENTS

D197,889 S	4/1964	Hass
3,885,550 A	5/1975	MacLeod
D257,495 S	11/1980	Bros et al.
4,590,942 A	5/1986	Brenman et al.
4,681,121 A	7/1987	Kobal
4,684,362 A	8/1987	Holt
5,099,829 A	3/1992	Wu
5,533,470 A	7/1996	Rose

5,577,983 A	11/1996	Fraser
5,683,436 A	11/1997	Mendes et al.
5,713,833 A	2/1998	Milligan
D437,938 S *	2/2001	Ko D24/200
6,604,528 B1	8/2003	Duncan
D484,608 S	12/2003	Tinsley
6,684,879 B1	2/2004	Coffee et al.
6,879,859 B1	4/2005	Boveja
7,117,033 B2	10/2006	Shalev et al.
7,228,184 B2	6/2007	Heath
D556,336 S	11/2007	Talbot et al.
7,650,186 B2	1/2010	Hastings et al.
D616,557 S	5/2010	Roehrig
7,805,200 B2	9/2010	Kast et al.
7,873,421 B2	1/2011	Karell
D631,972 S	2/2011	Imboden et al.
8,080,047 B2	12/2011	Yu
D657,066 S	4/2012	Imboden et al.
8,251,983 B2	8/2012	Larson et al.
D681,839 S	5/2013	Nathanson
8,494,641 B2	7/2013	Boling et al.
D692,571 S	10/2013	Luzon et al.
D696,411 S	12/2013	Imboden et al.
D696,412 S	12/2013	Imboden et al.
D697,222 S	1/2014	Imboden et al.
D699,366 S	2/2014	Marshall
D699,367 S	2/2014	Lee et al.
8,676,324 B2	3/2014	Simon et al.
8,728,136 B2	5/2014	Feldman
D712,565 S	9/2014	Guang
8,821,421 B2	9/2014	Imboden et al.
8,936,594 B2	1/2015	Wolf et al.
8,986,301 B2	3/2015	Wolf et al.
8,996,137 B2	3/2015	Ackermann et al.
D739,541 S *	9/2015	Cole D24/200
D739,546 S	9/2015	Cheung
D756,527 S *	5/2016	Cole D24/200
9,717,643 B2	8/2017	Guang
D824,037 S *	7/2018	Yueh D24/215
D826,420 S *	8/2018	Ackermann D24/215
D829,335 S *	9/2018	Park D24/215
D837,396 S	1/2019	Ackermann et al.
2002/0188331 A1	12/2002	Fang et al.
2004/0098036 A1	5/2004	Bergersen
2004/0220644 A1	11/2004	Shalev et al.
2006/0095108 A1	5/2006	Chowdhury et al.
2006/0107958 A1	5/2006	Sleeper
2006/0271024 A1	11/2006	Gertner et al.
2007/0150034 A1	6/2007	Rooney et al.
2007/0219600 A1	9/2007	Gertner et al.
2007/0248930 A1	10/2007	Brawn
2008/0009897 A1	1/2008	Duran Von Arx
2008/0033512 A1	2/2008	Yu

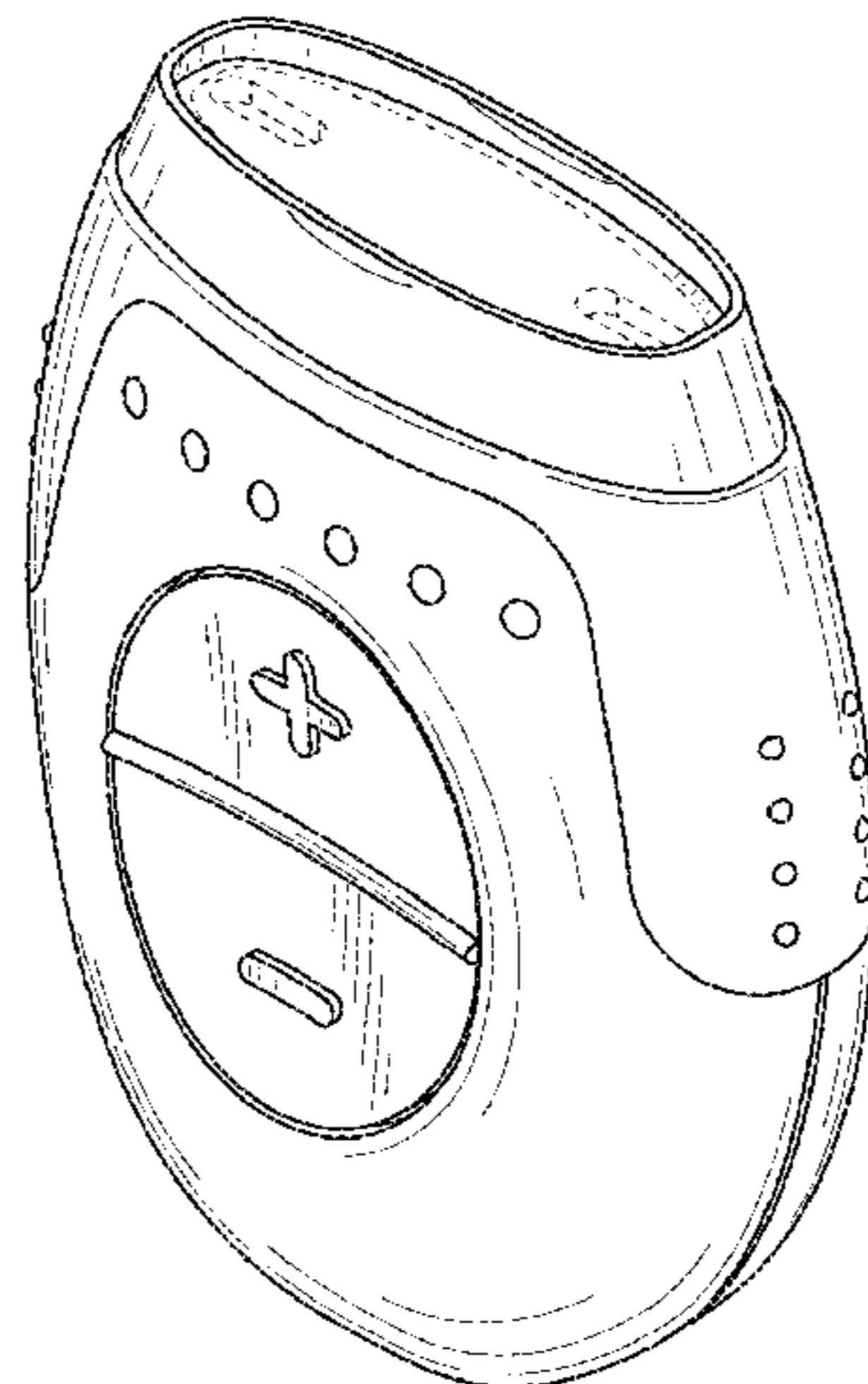

2008/0109054	A1	5/2008	Hastings et al.	
2009/0012573	A1	1/2009	Karell	
2009/0018582	A1	1/2009	Ishikawa et al.	
2009/0101139	A1	4/2009	Karell	
2009/0281596	A1	11/2009	King et al.	
2010/0179457	A1	7/2010	Blaine et al.	
2010/0249763	A1	9/2010	Larson et al.	
2010/0288275	A1	11/2010	Djupestrand et al.	
2010/0318159	A1	12/2010	Aghassian et al.	
2011/0021975	A1	1/2011	Covello	
2011/0077551	A1	3/2011	Videbaek	
2011/0202121	A1	8/2011	Wen	
2011/0276107	A1	11/2011	Simon et al.	
2011/0282251	A1	11/2011	Baker et al.	
2012/0130398	A1	5/2012	Ackermann et al.	
2012/0197338	A1	8/2012	Su et al.	
2012/0232615	A1	9/2012	Barolat et al.	
2012/0232618	A1	9/2012	Feldman	
2012/0234332	A1	9/2012	Shantha	
2012/0316557	A1	12/2012	Sartor et al.	
2012/0323227	A1	12/2012	Wolf et al.	
2012/0323232	A1	12/2012	Wolf et al.	
2013/0006326	A1	1/2013	Ackermann et al.	
2013/0138451	A1	5/2013	Shiono et al.	
2013/0253387	A1	9/2013	Bonutti et al.	
2014/0081353	A1	3/2014	Cook et al.	
2014/0088463	A1	3/2014	Wolf et al.	
2014/0316310	A1*	10/2014	Ackermann	A61N 1/36146 601/46
2014/0316396	A1	10/2014	Wolf et al.	
2017/0157401	A1*	6/2017	Loudin	A61B 5/053
2017/0239459	A1*	8/2017	Loudin	A61N 1/36014
2020/0155830	A1*	5/2020	Baldwin	A61N 1/0456
2020/0155831	A1*	5/2020	Wardle	A61N 1/36025
2020/0238076	A1*	7/2020	Ackermann	A61N 1/36175

FOREIGN PATENT DOCUMENTS

EM	2102681-0001	10/2012
EM	2199000-0001	3/2013
GB	2 129 690 B	3/1987
WO	WO-2005/030025 A2	4/2005
WO	WO-2005/030025 A3	4/2005
WO	WO-2011/011373 A1	1/2011
WO	WO-2013/165697 A1	11/2013

OTHER PUBLICATIONS

Biodesign, “Tackling Dry Eye”, Aug. 19, 2020. <https://biodesign.stanford.edu/our-impact/technologies/oculeve.html>. Shown on p. 1. (Year: 2020).*

Youtube, “Allergan TrueTear”, May 19, 2017. <https://www.youtube.com/watch?v=mbNPGg60Rpc>. Shown at the 00:50 minute mark. (Year: 2017).*

Office Action received for Canadian Patent Application No. 159163, dated Feb. 6, 2015, 2 pages.

Office Action Received for Mexican Patent Application No. MXF2014003178, dated Sep. 22, 2015, 6 pages (3 pages of English Translation).

Notice of Allowance received for U.S. Appl. No. 29/488,488, dated Jan. 29, 2016, 10 pages.

* cited by examiner

Primary Examiner — Cynthia Ramirez
Assistant Examiner — Michael A Maharajh

(74) *Attorney, Agent, or Firm* — Mintz Levin Cohn Ferris Glovsky and Popeo, P.C.

(57) **CLAIM**

The ornamental design for a nasal stimulator body, as shown and described.

DESCRIPTION

FIG. 1 is a front perspective view of a first embodiment of a nasal stimulator body showing the new design; FIG. 2 is a front elevation view thereof; FIG. 3 is a rear elevation view thereof; FIG. 4 is a right side elevation view thereof; FIG. 5 is a left side elevation view thereof; FIG. 6 is a top plan view thereof; and FIG. 7 is a bottom plan view thereof. FIG. 8 is a front perspective view of a second embodiment of a nasal stimulator body showing the new design; FIG. 9 is a front elevation view thereof; FIG. 10 is a rear elevation view thereof; FIG. 11 is a right side elevation view thereof; FIG. 12 is a left side elevation view thereof; FIG. 13 is a top plan view thereof; and FIG. 14 is a bottom plan view thereof. FIG. 15 is a front perspective view of a third embodiment of a nasal stimulator body showing the new design; FIG. 16 is a front elevation view thereof; FIG. 17 is a rear elevation view thereof; FIG. 18 is a right side elevation view thereof; FIG. 19 is a left side elevation view thereof; FIG. 20 is a top plan view thereof; and FIG. 21 is a bottom plan view thereof. FIG. 22 is a front perspective view of a fourth embodiment of a nasal stimulator body showing the new design; FIG. 23 is a front elevation view thereof; FIG. 24 is a rear elevation view thereof; FIG. 25 is a right side elevation view thereof; FIG. 26 is a left side elevation view thereof; FIG. 27 is a top plan view thereof; and FIG. 28 is a bottom plan view thereof. FIG. 29 is a front perspective view of a fifth embodiment of a nasal stimulator body showing the new design; FIG. 30 is a front elevation view thereof; FIG. 31 is a rear elevation view thereof; FIG. 32 is a right side elevation view thereof; FIG. 33 is a left side elevation view thereof; FIG. 34 is a top plan view thereof; and FIG. 35 is a bottom plan view thereof. FIG. 36 is a front perspective view of a sixth embodiment of a nasal stimulator body showing the new design; FIG. 37 is a front elevation view thereof; FIG. 38 is a rear elevation view thereof; FIG. 39 is a right side elevation view thereof; FIG. 40 is a left side elevation view thereof; FIG. 41 is a top plan view thereof; and FIG. 42 is a bottom plan view thereof. The broken lines in the drawings are for the purpose of illustrating portions of the nasal stimulator body, which form no part of the claimed design.

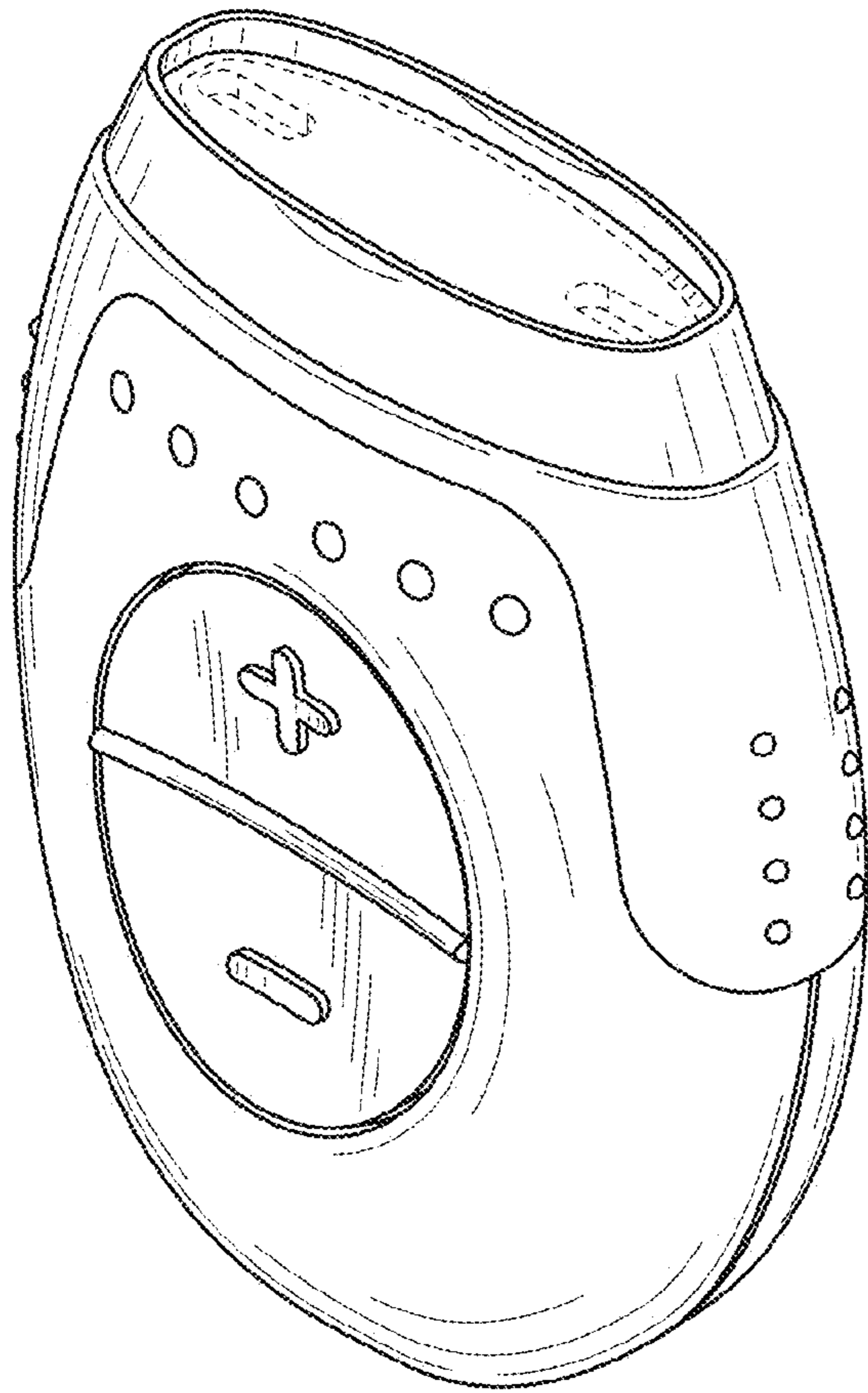

FIG. 1

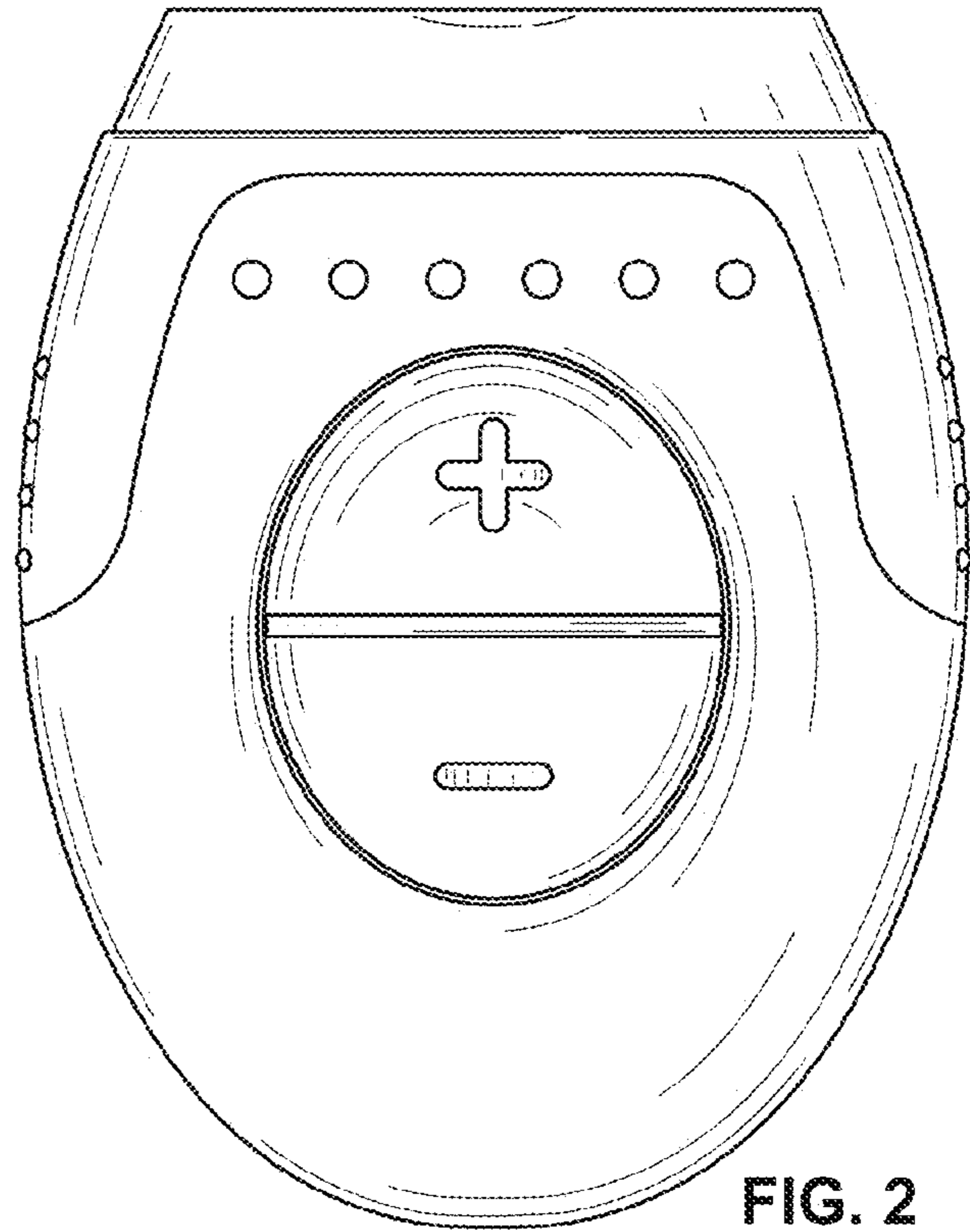

FIG. 2

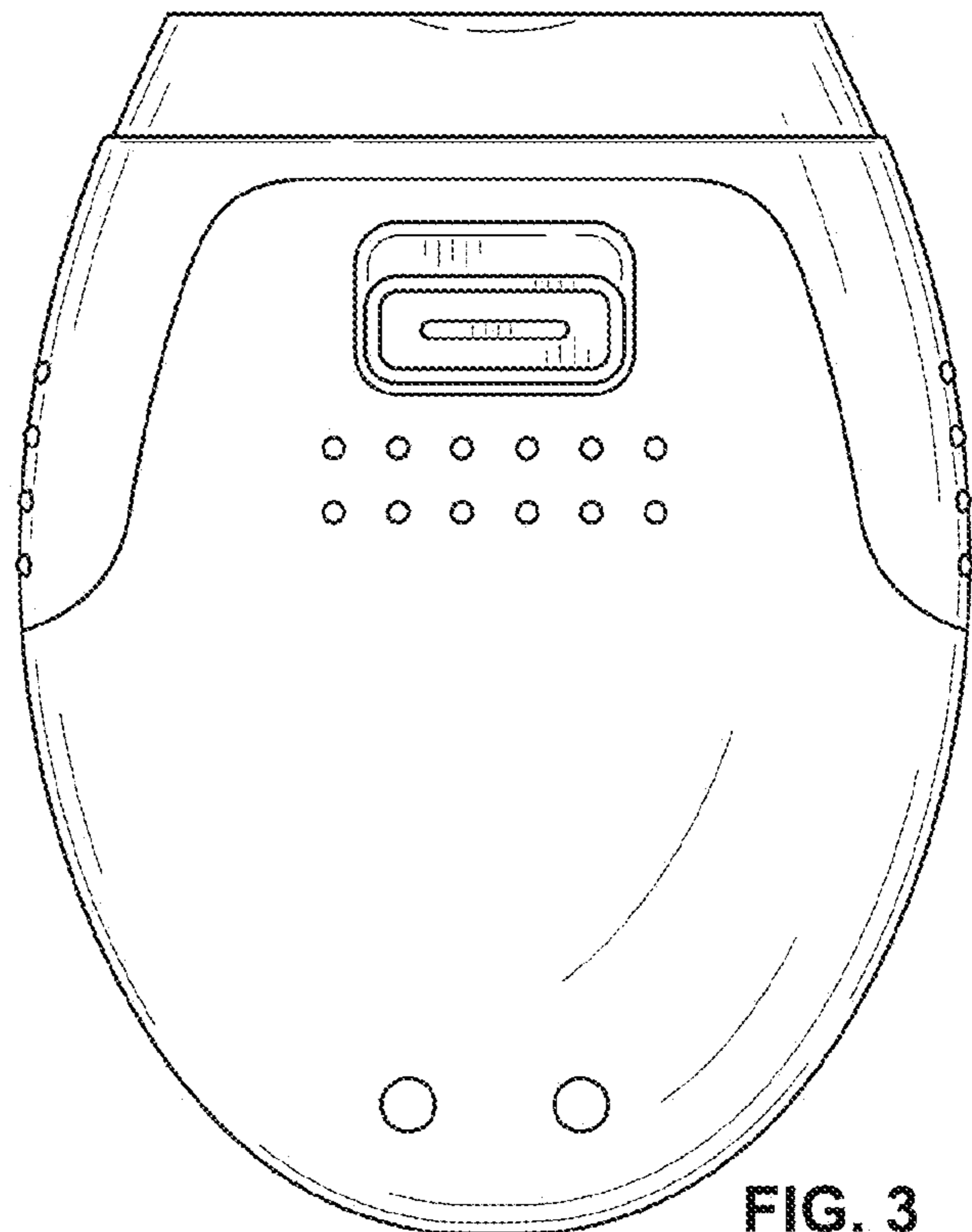

FIG. 3

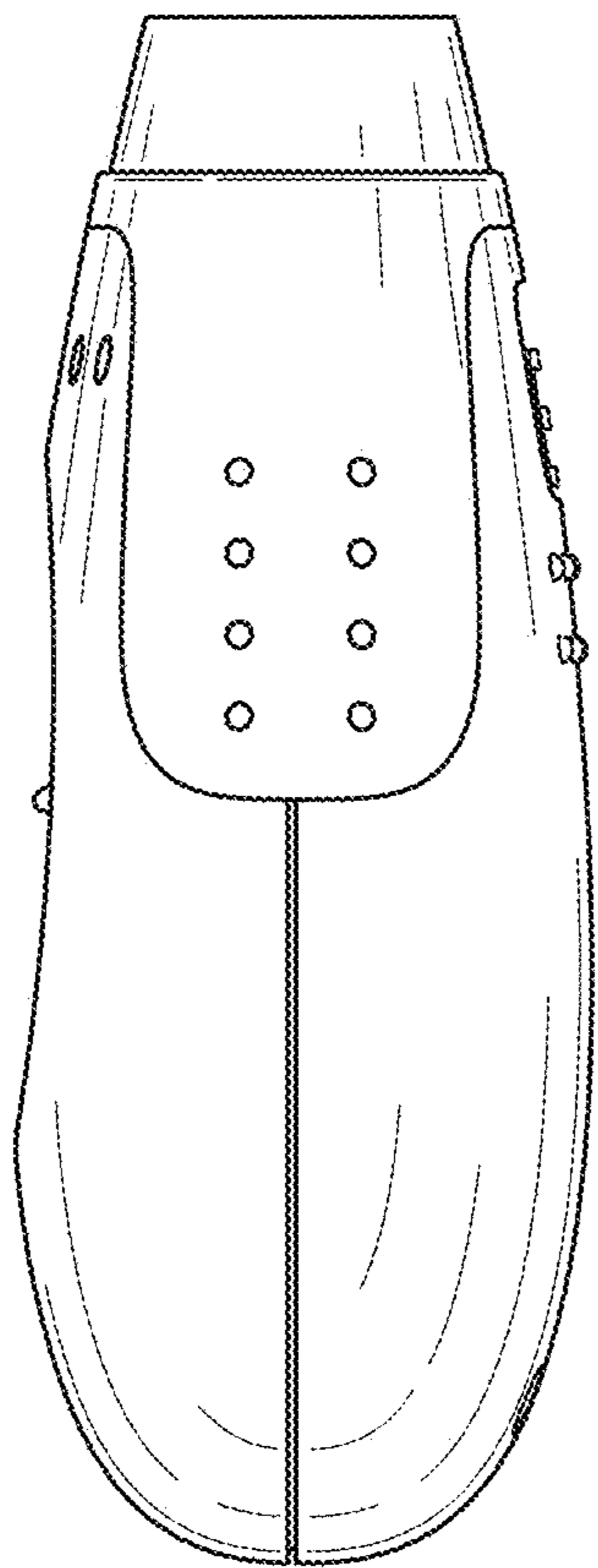

FIG. 4

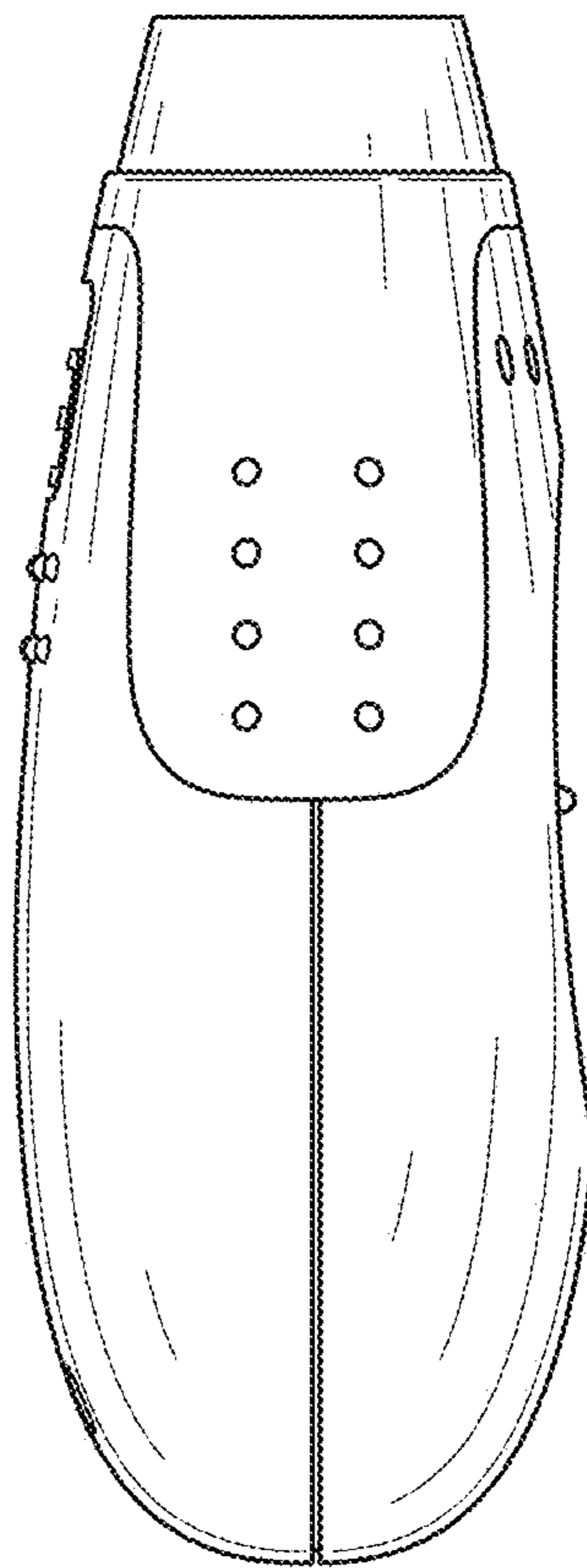

FIG. 5

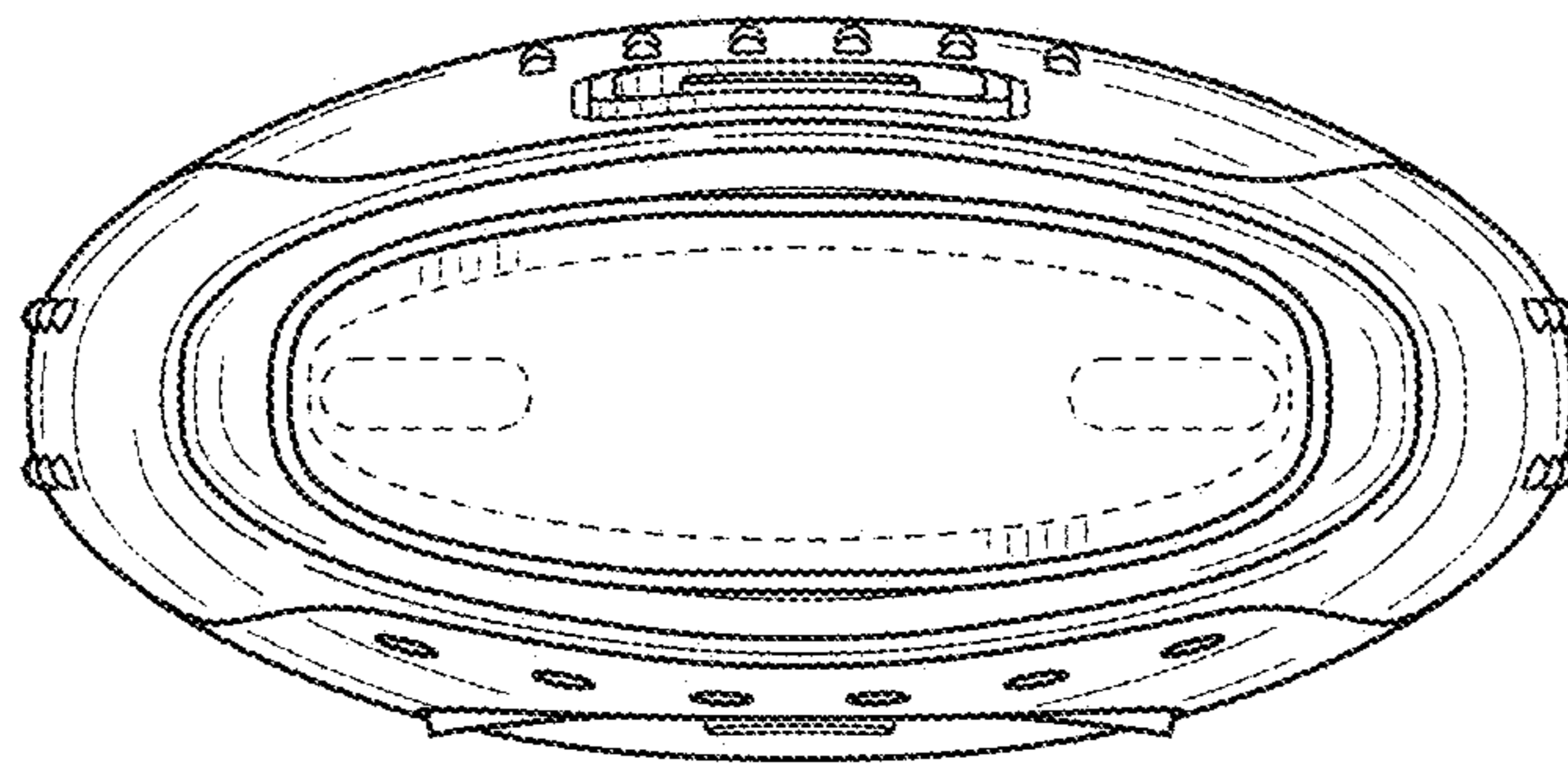

FIG. 6

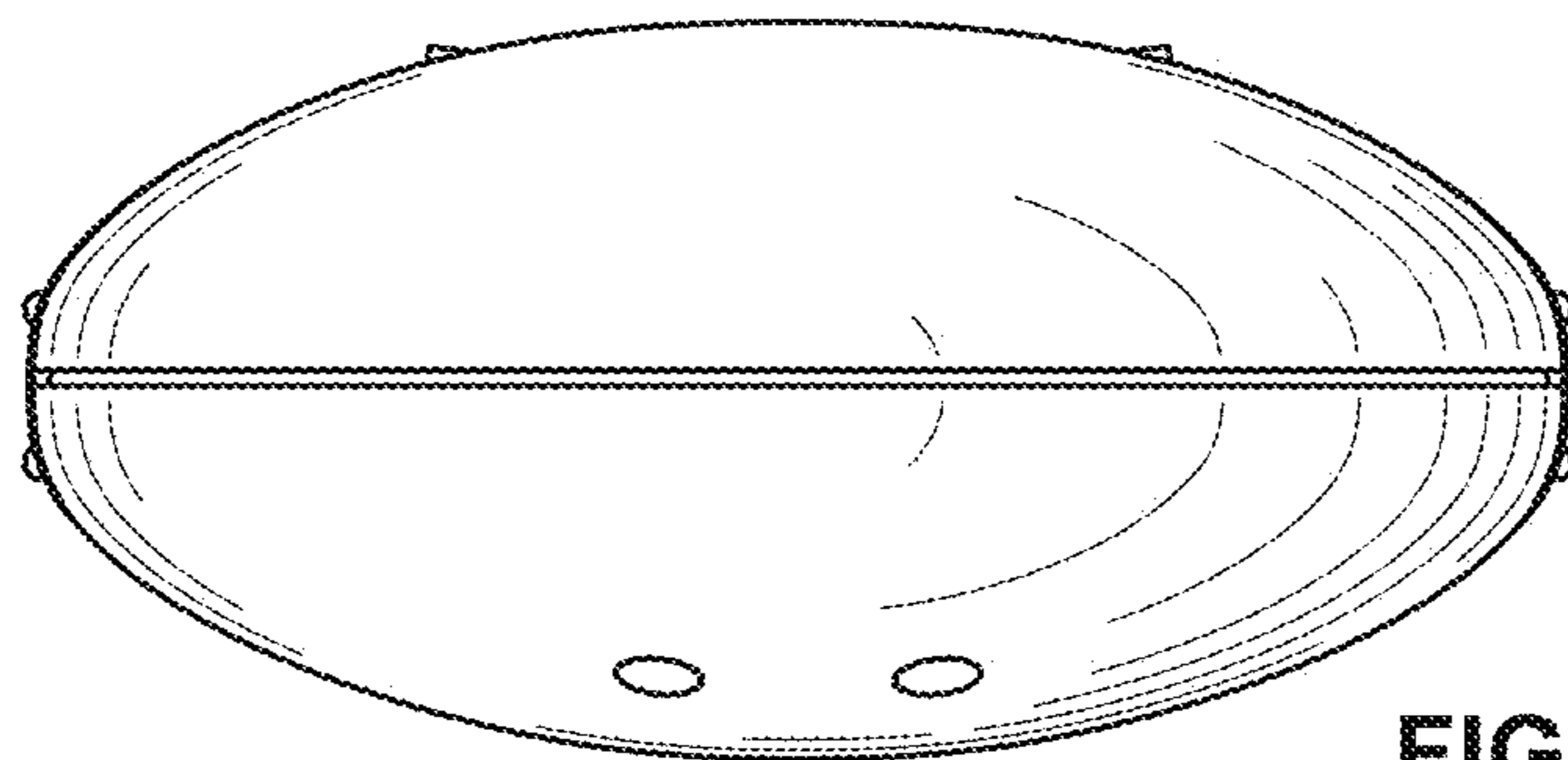

FIG. 7

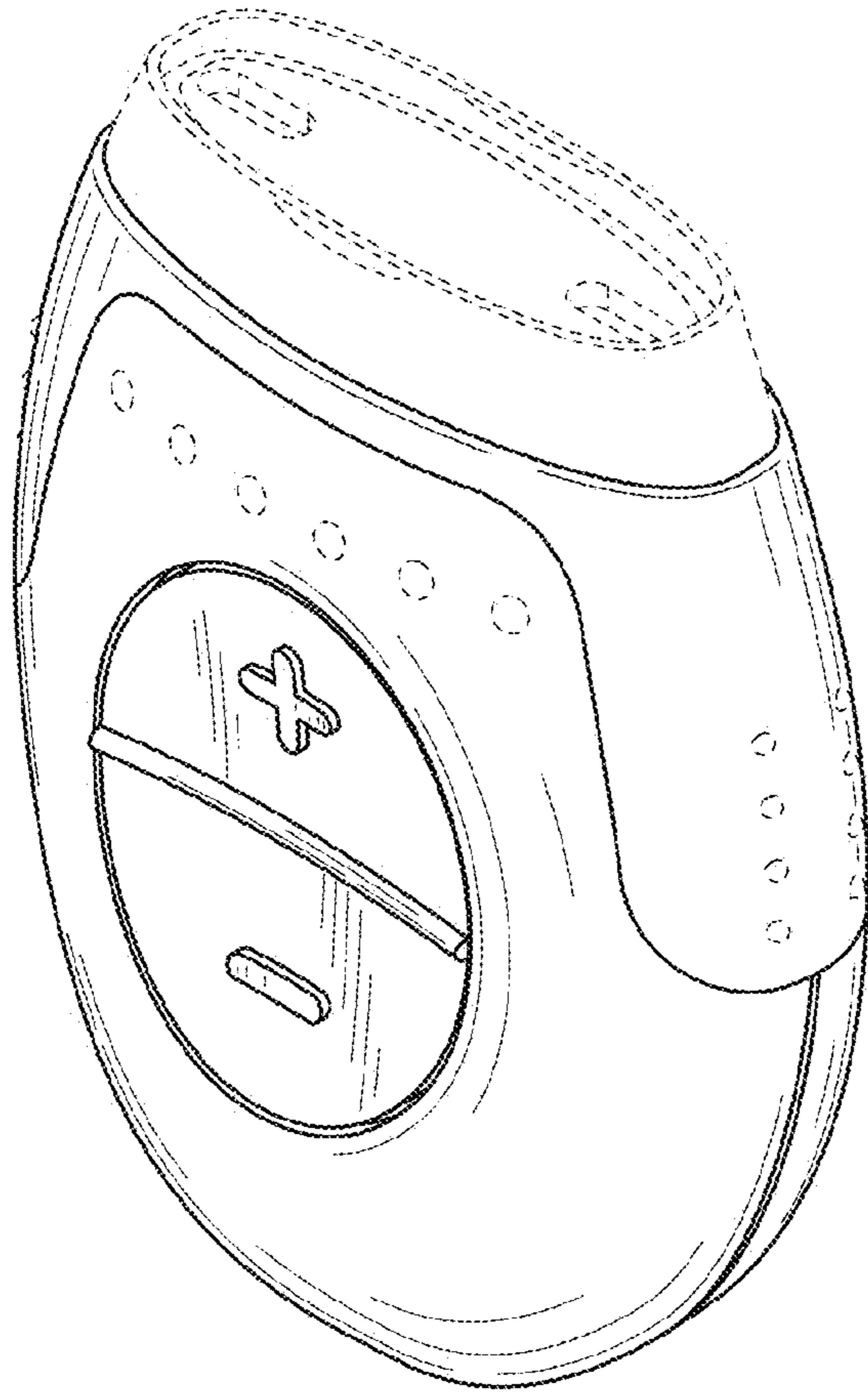

FIG. 8

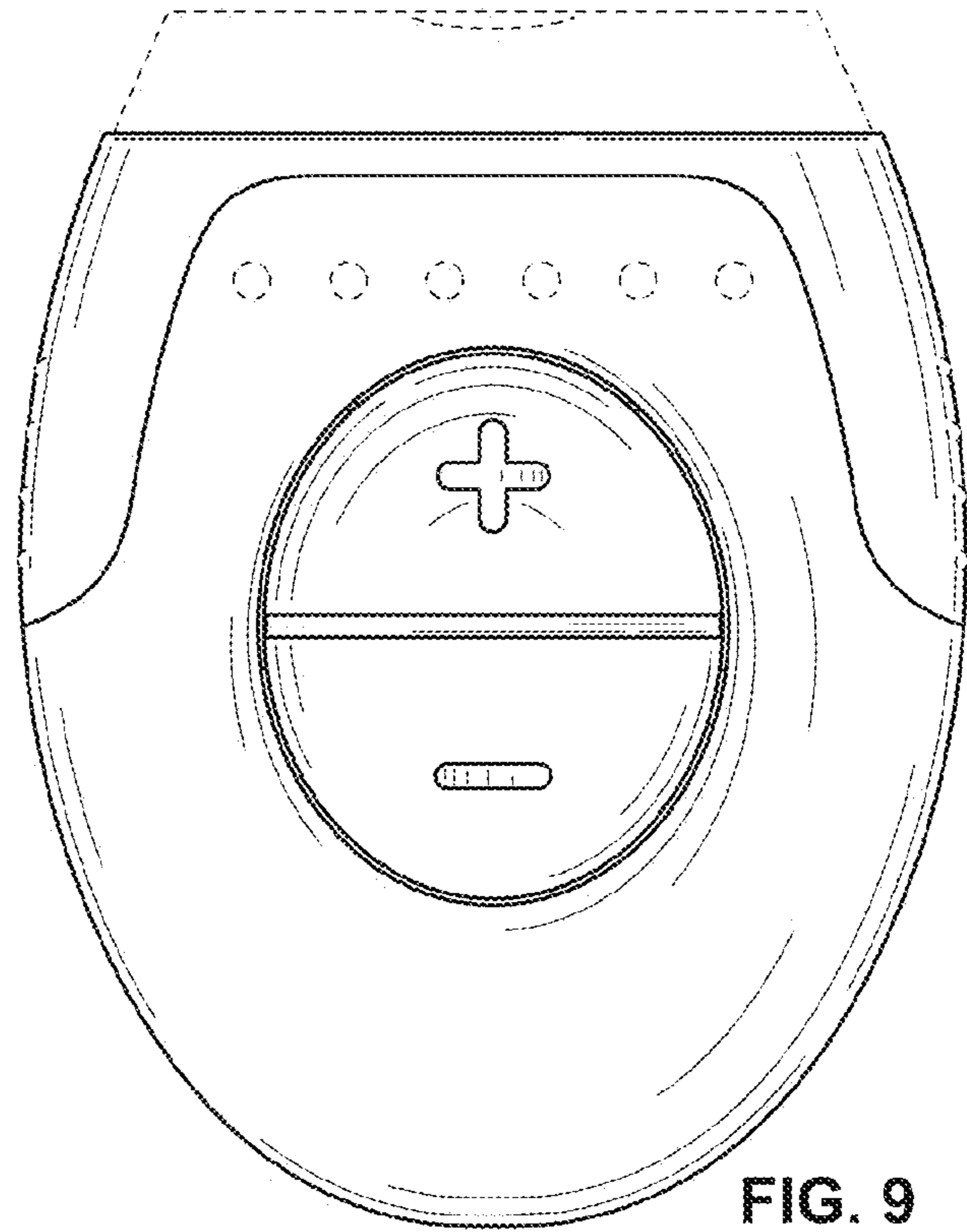

FIG. 9

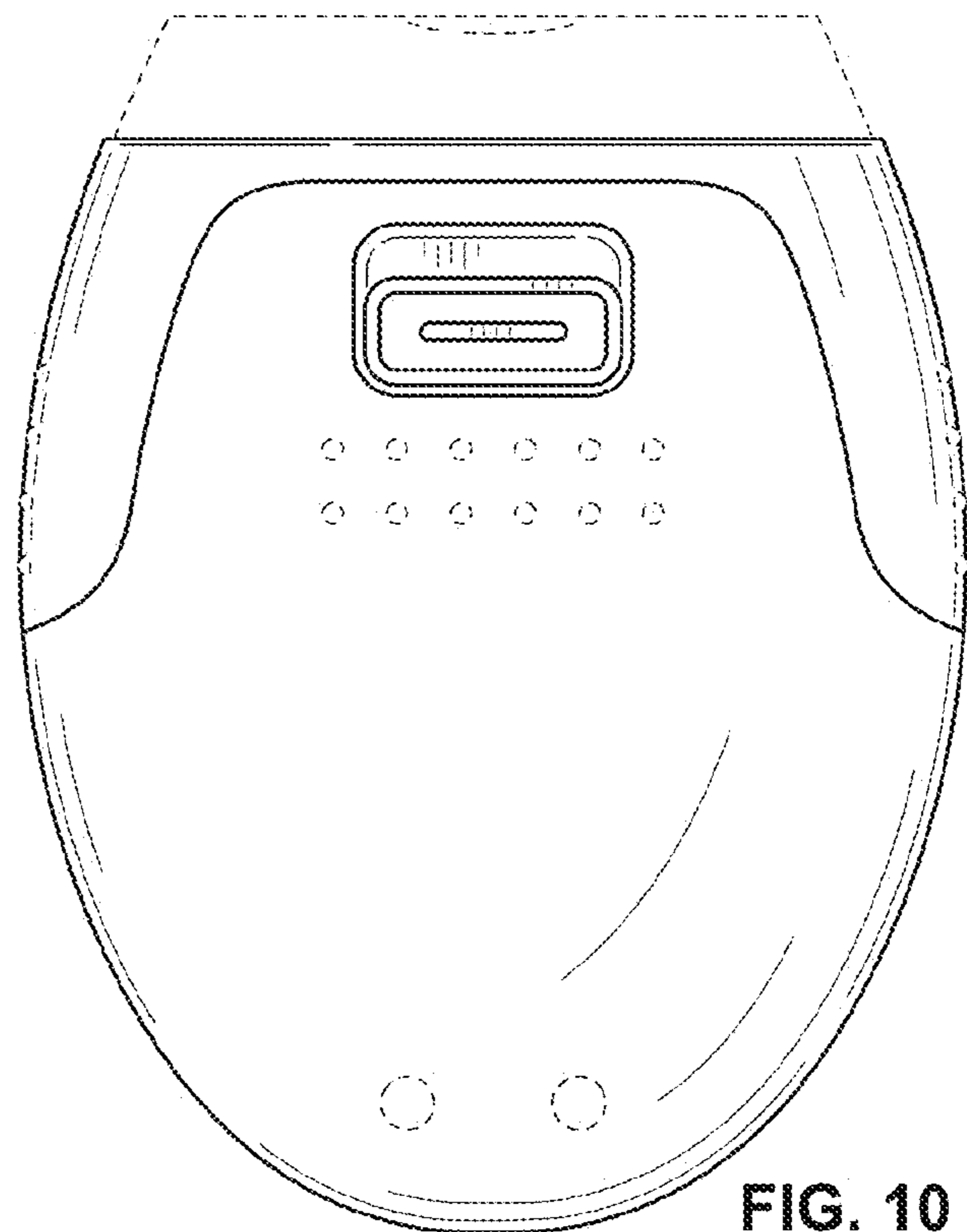

FIG. 10

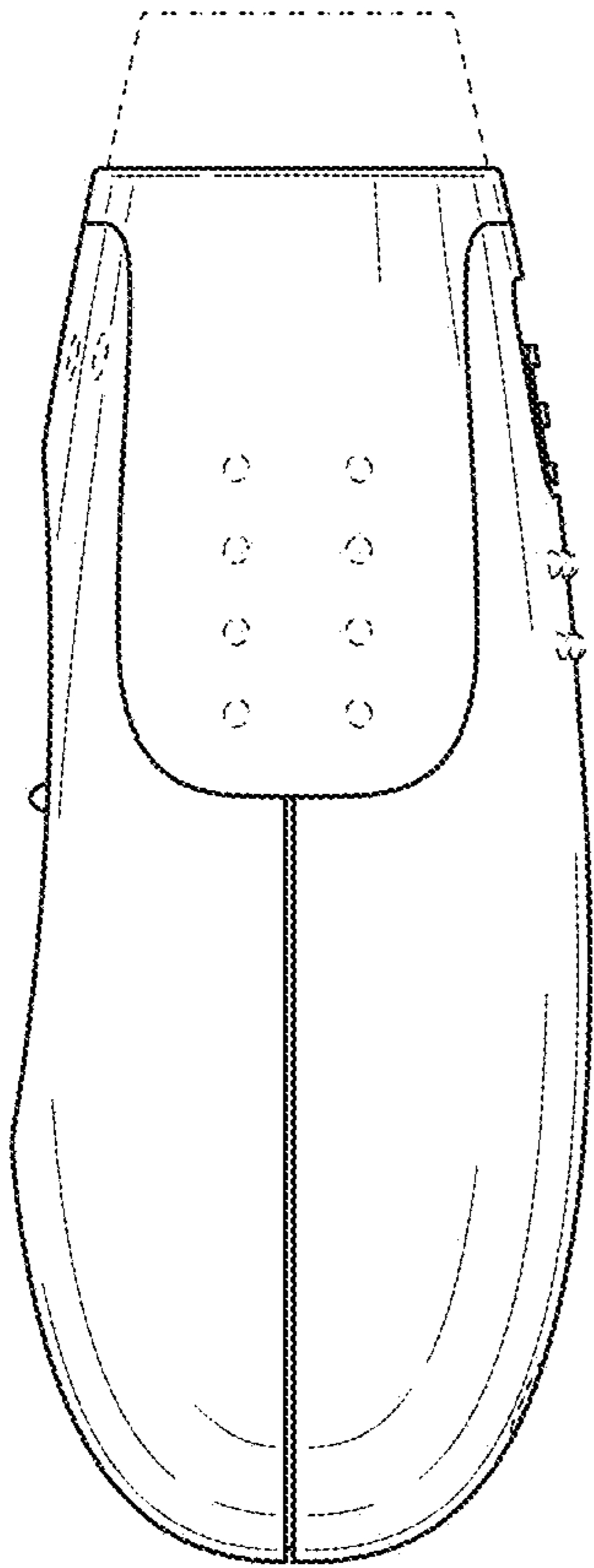

FIG. 11

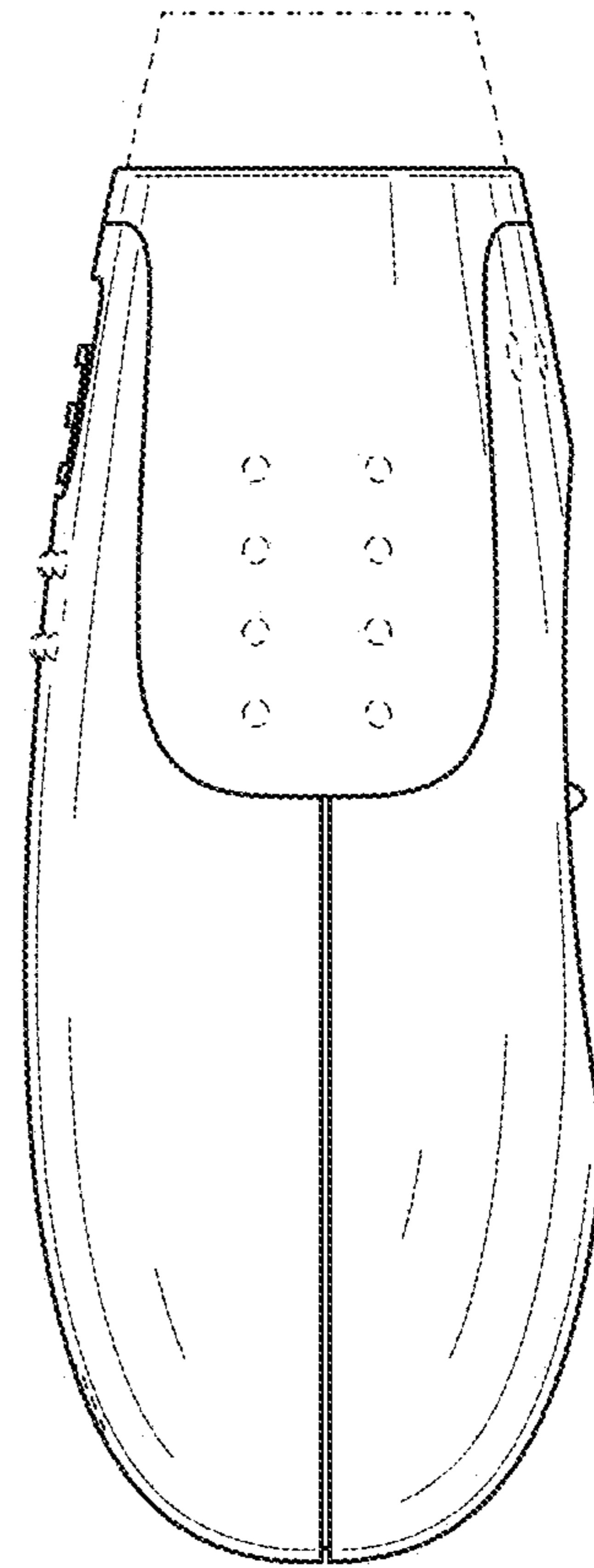

FIG. 12

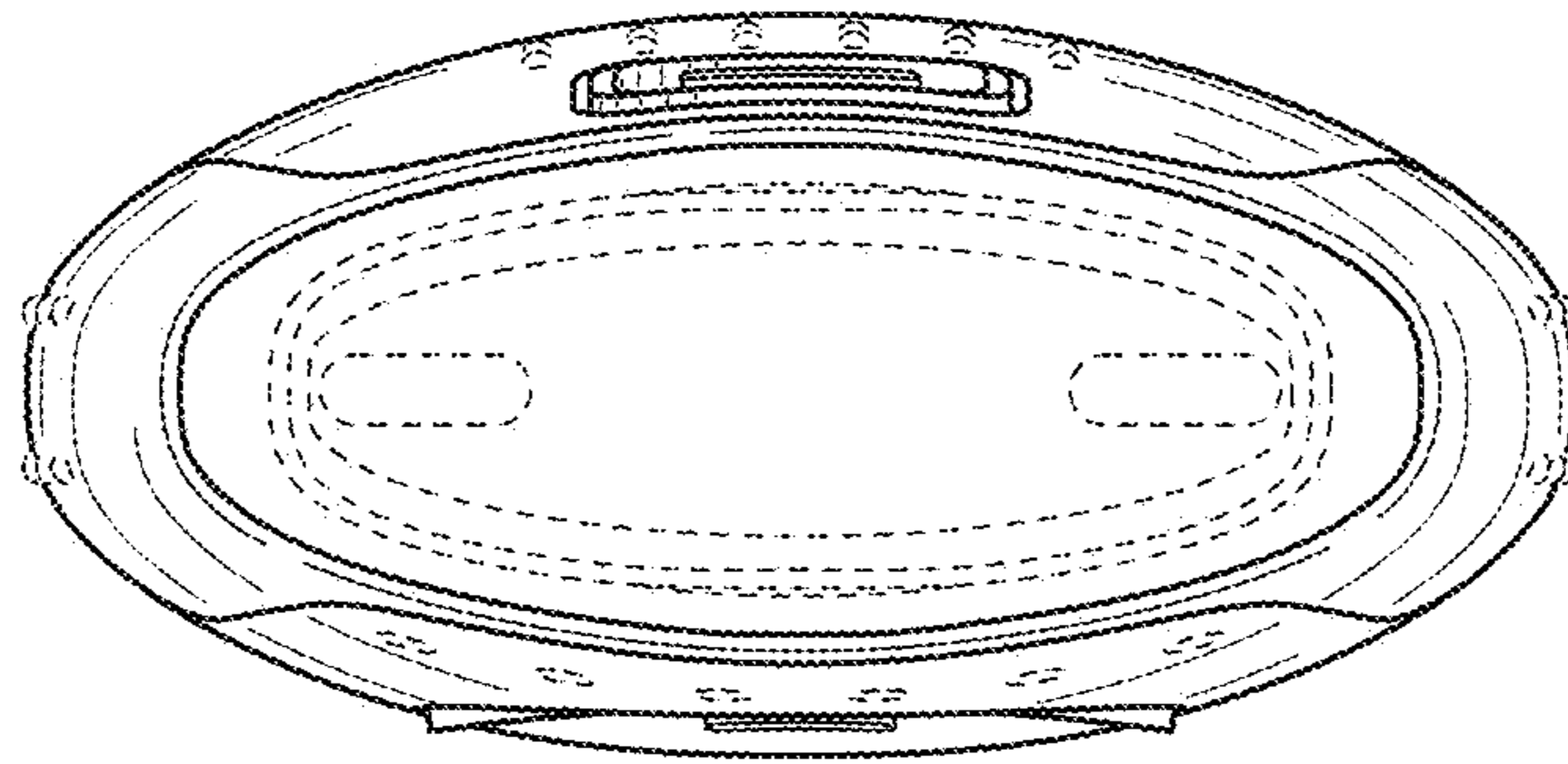

FIG. 13

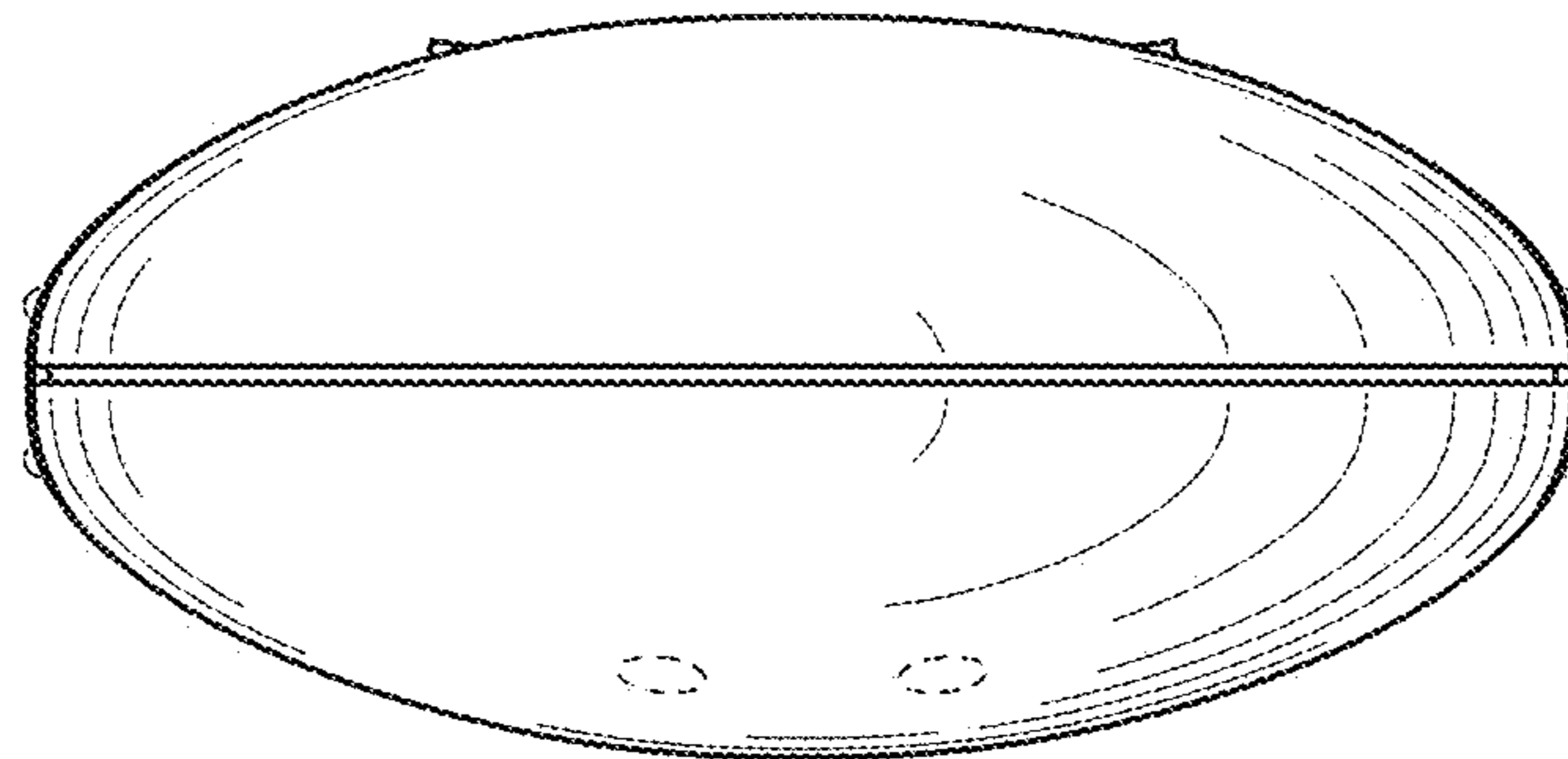

FIG. 14

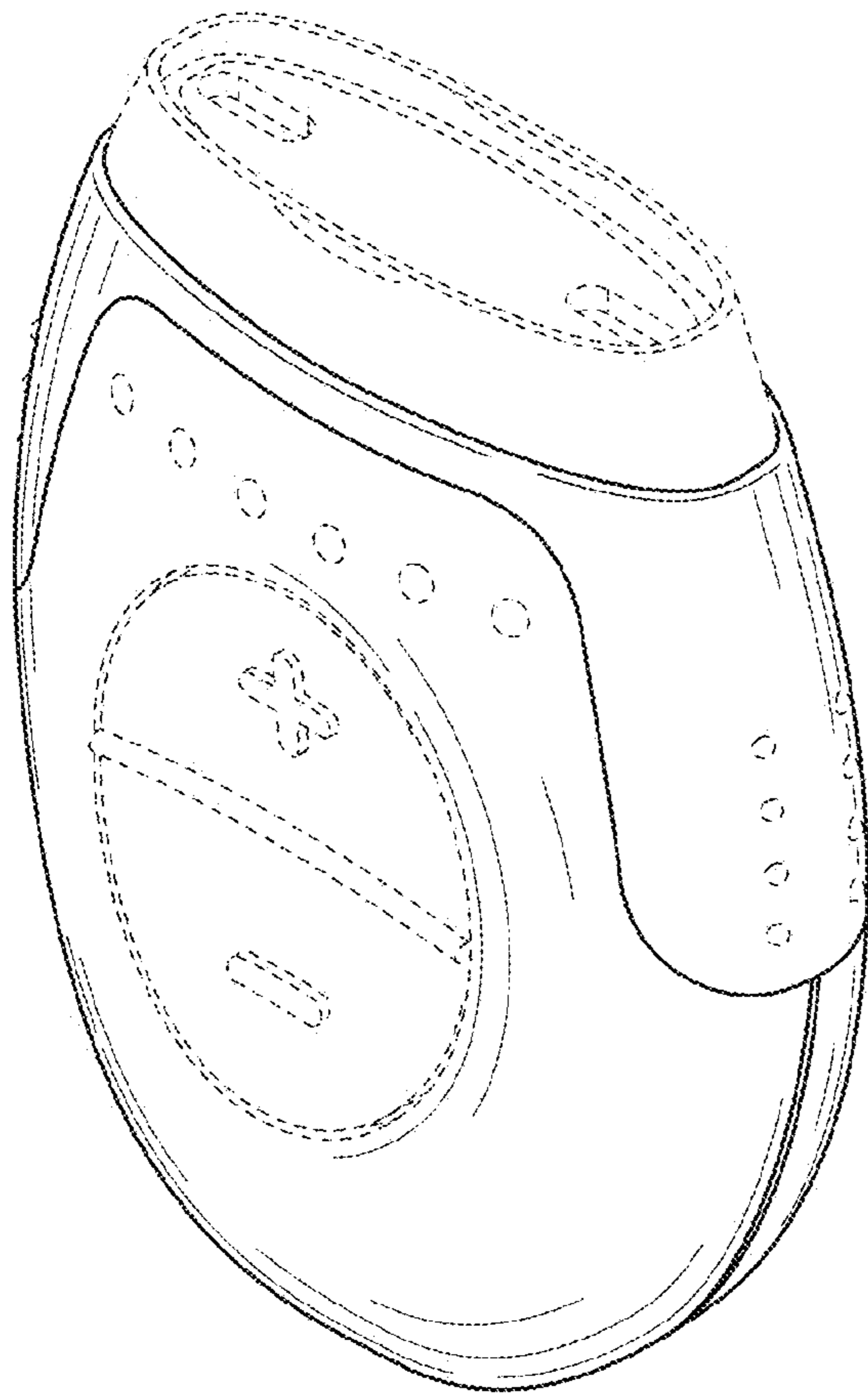

FIG. 15

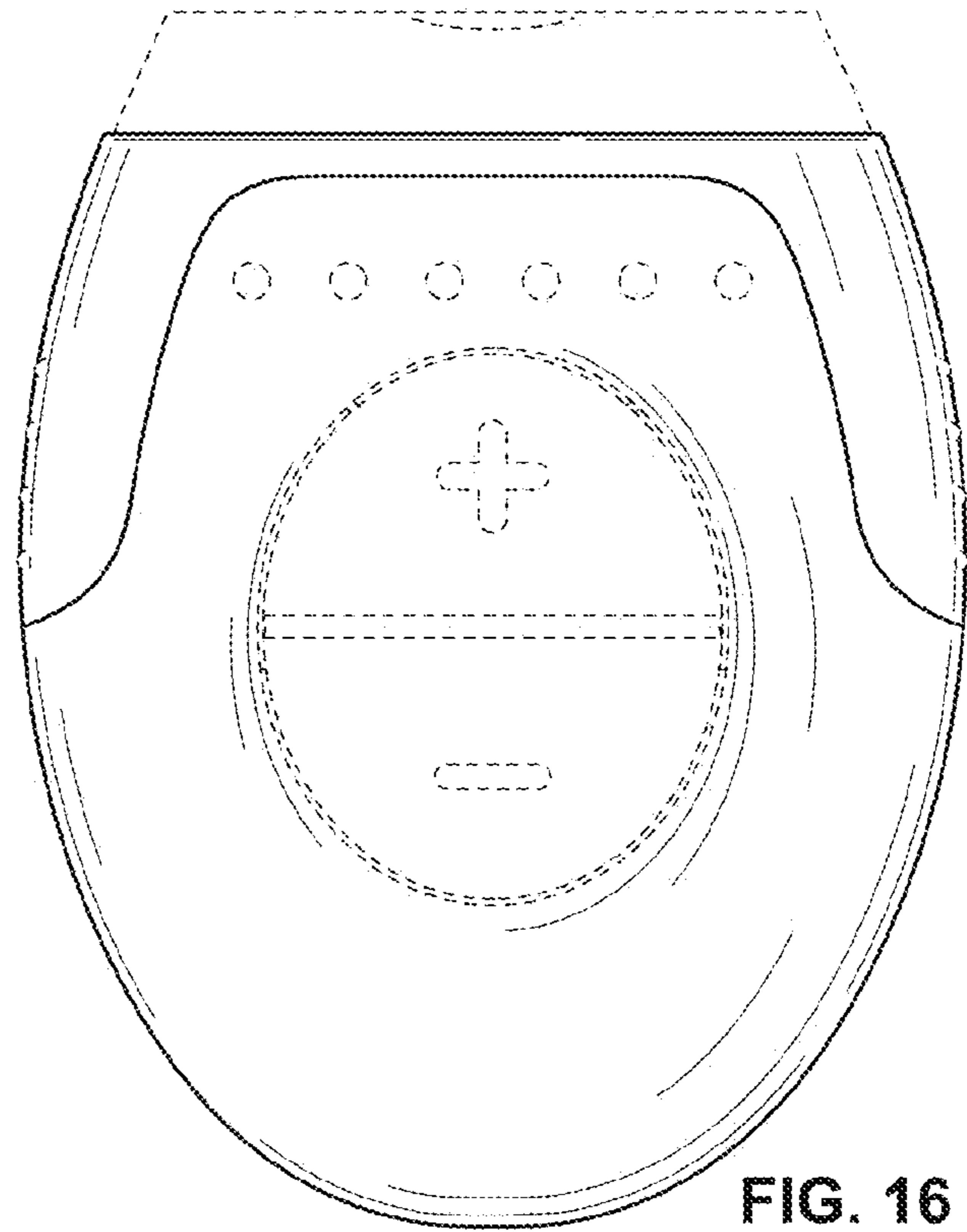

FIG. 16

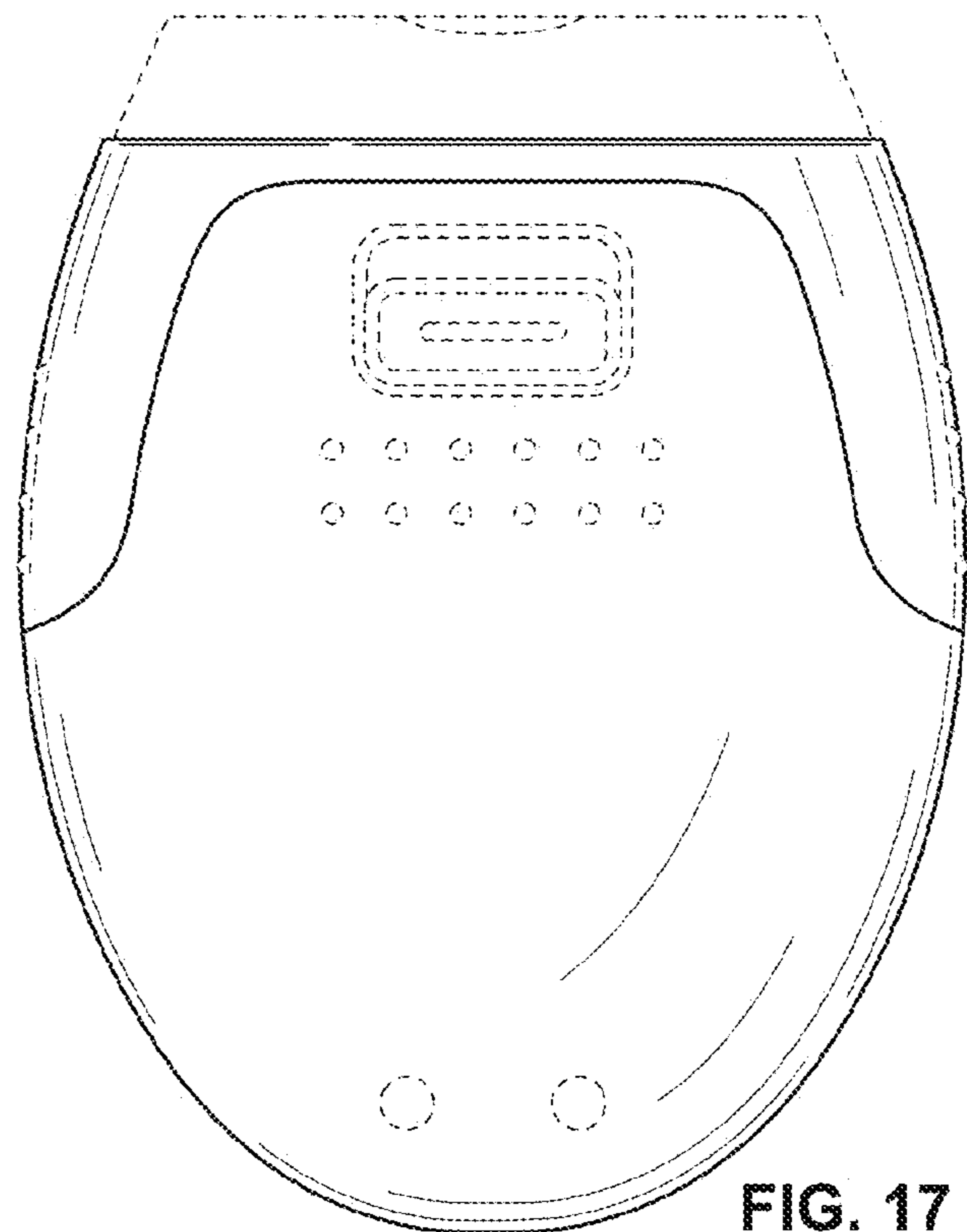

FIG. 17

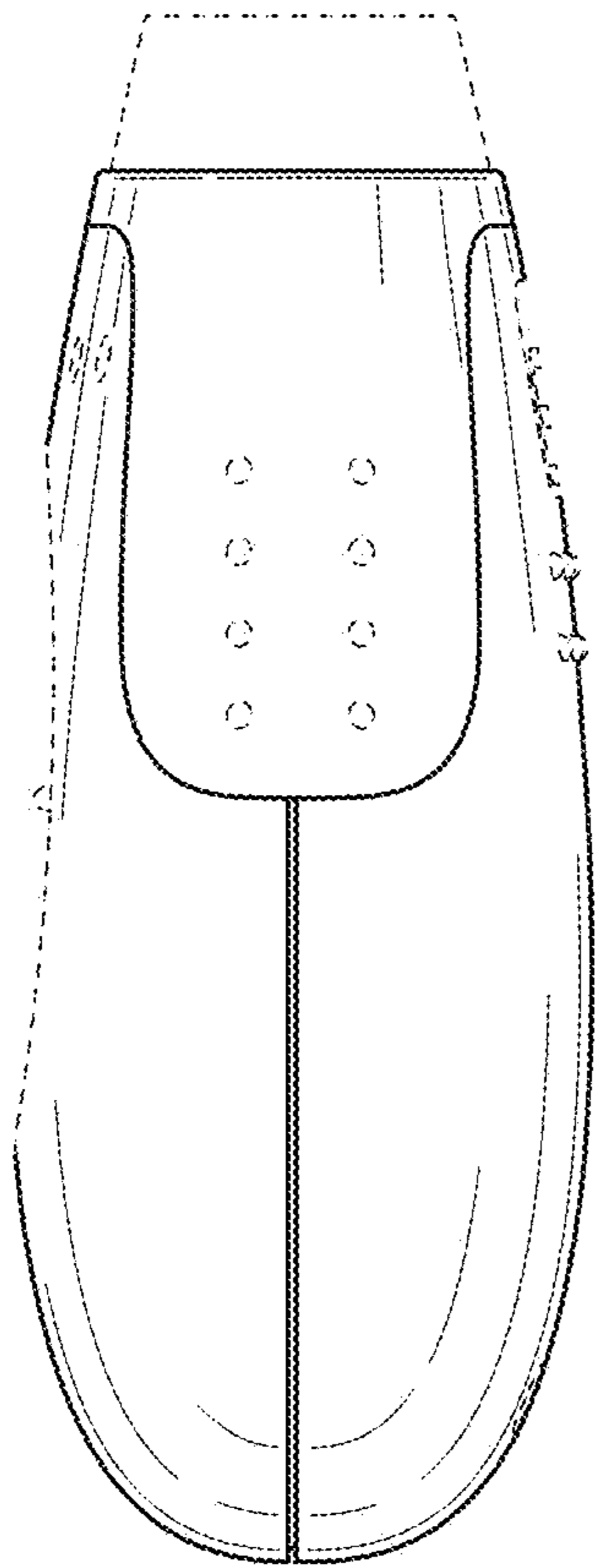

FIG. 18

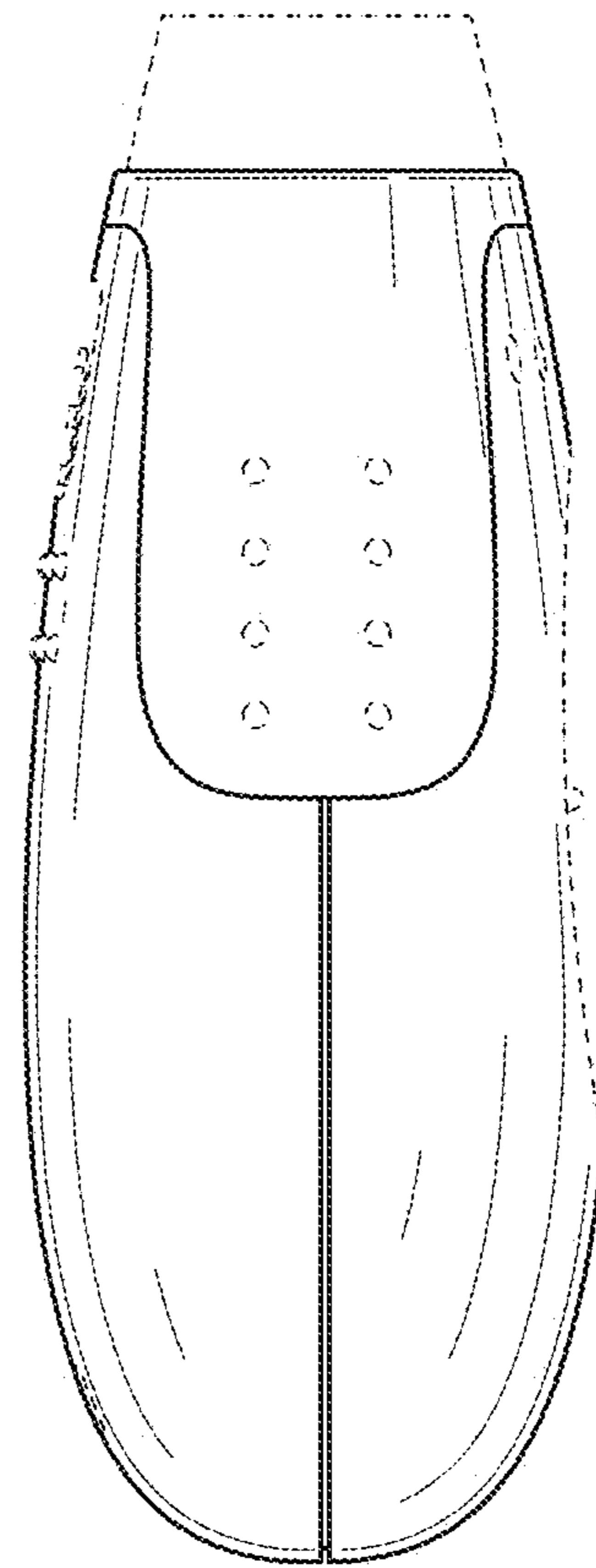

FIG. 19

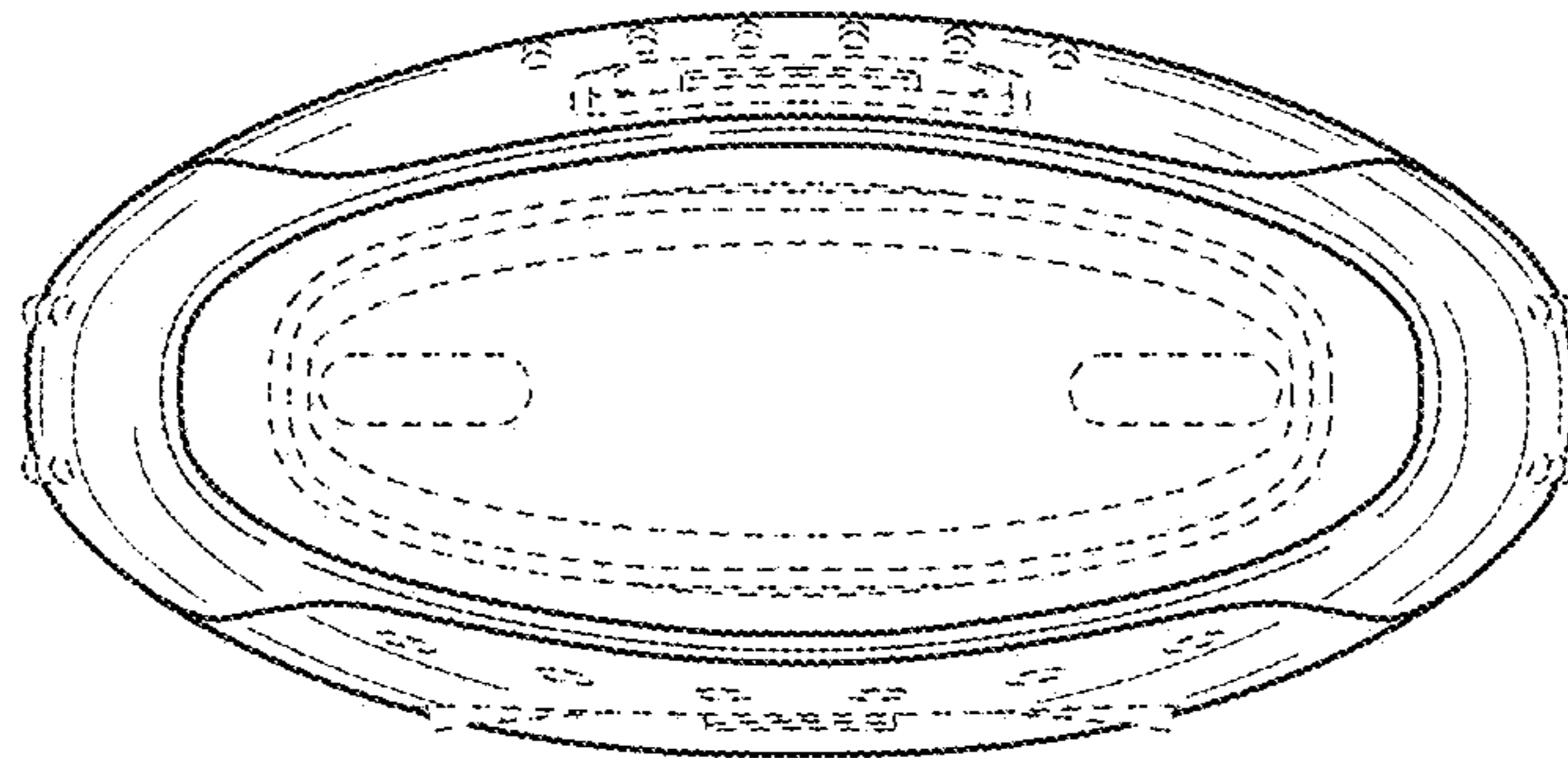

FIG. 20

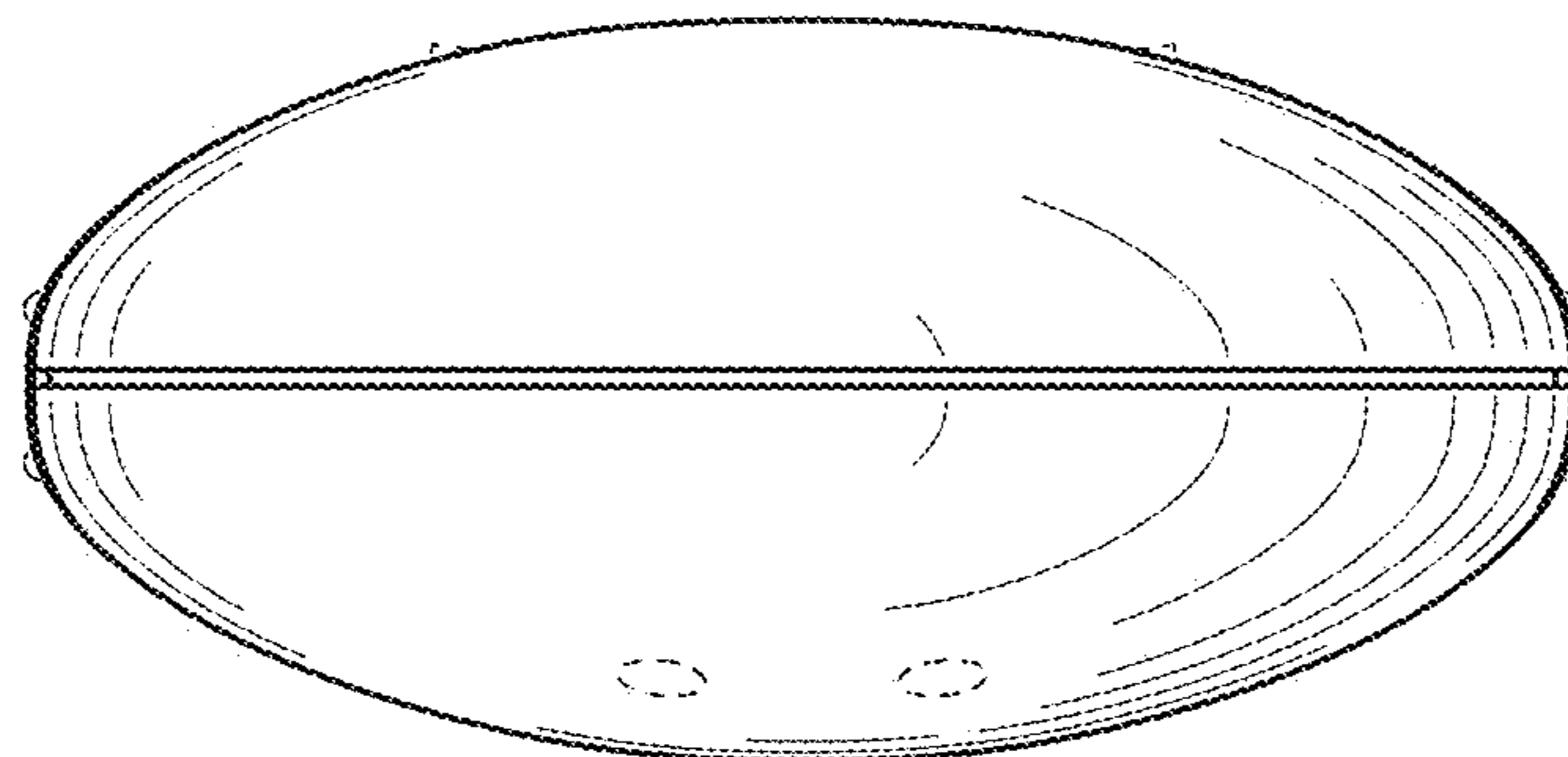

FIG. 21

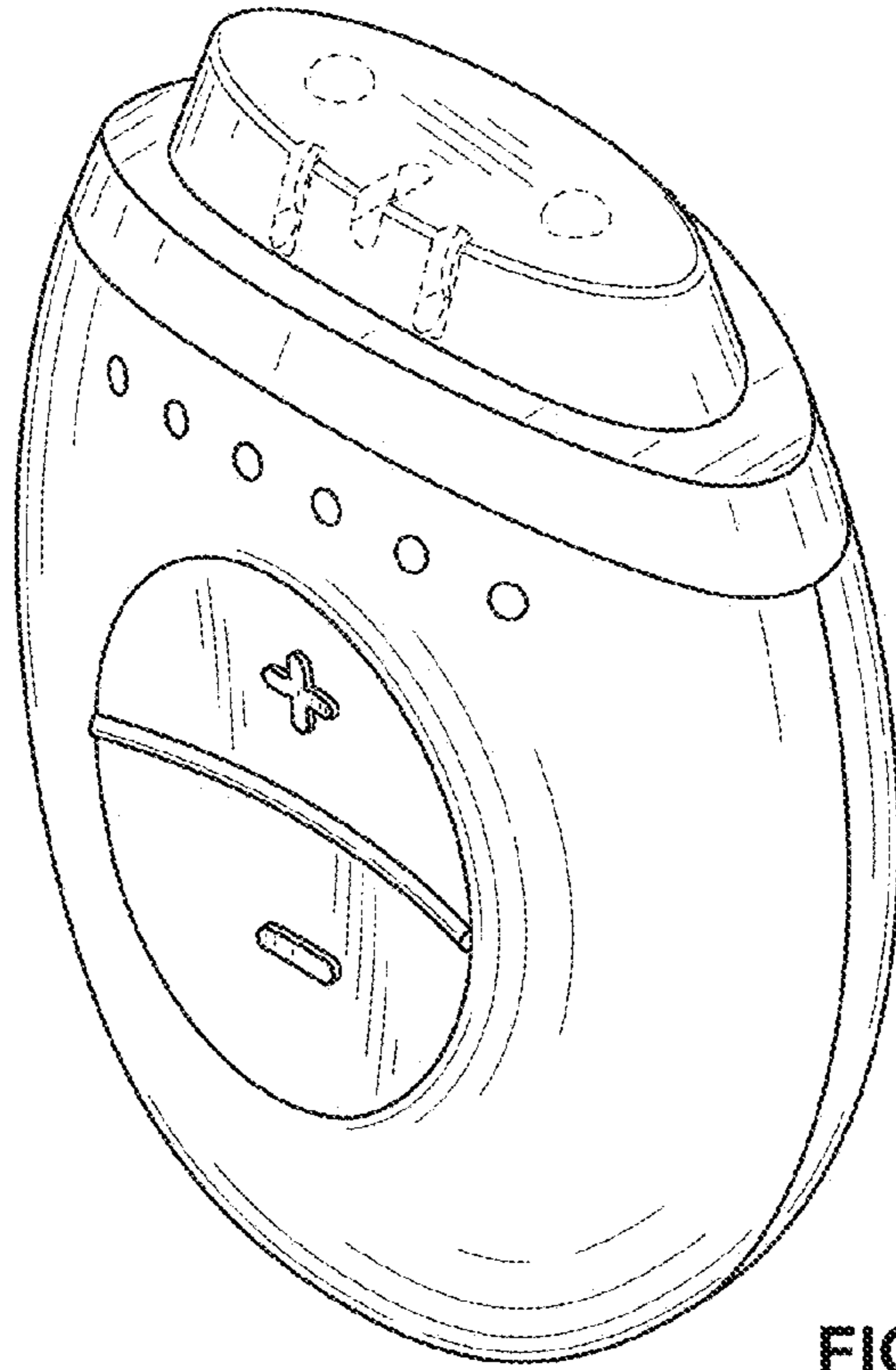

FIG. 22

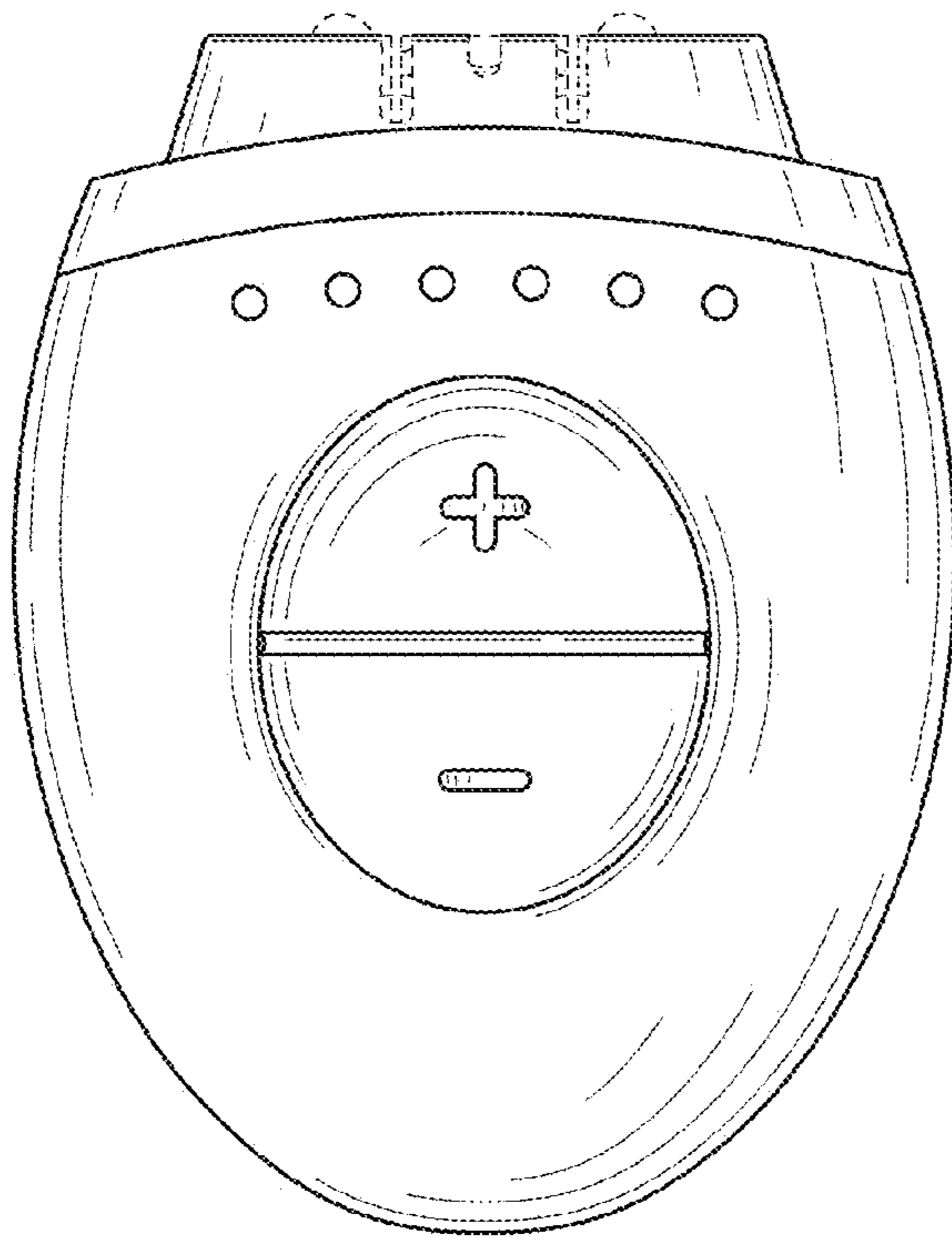

FIG. 23

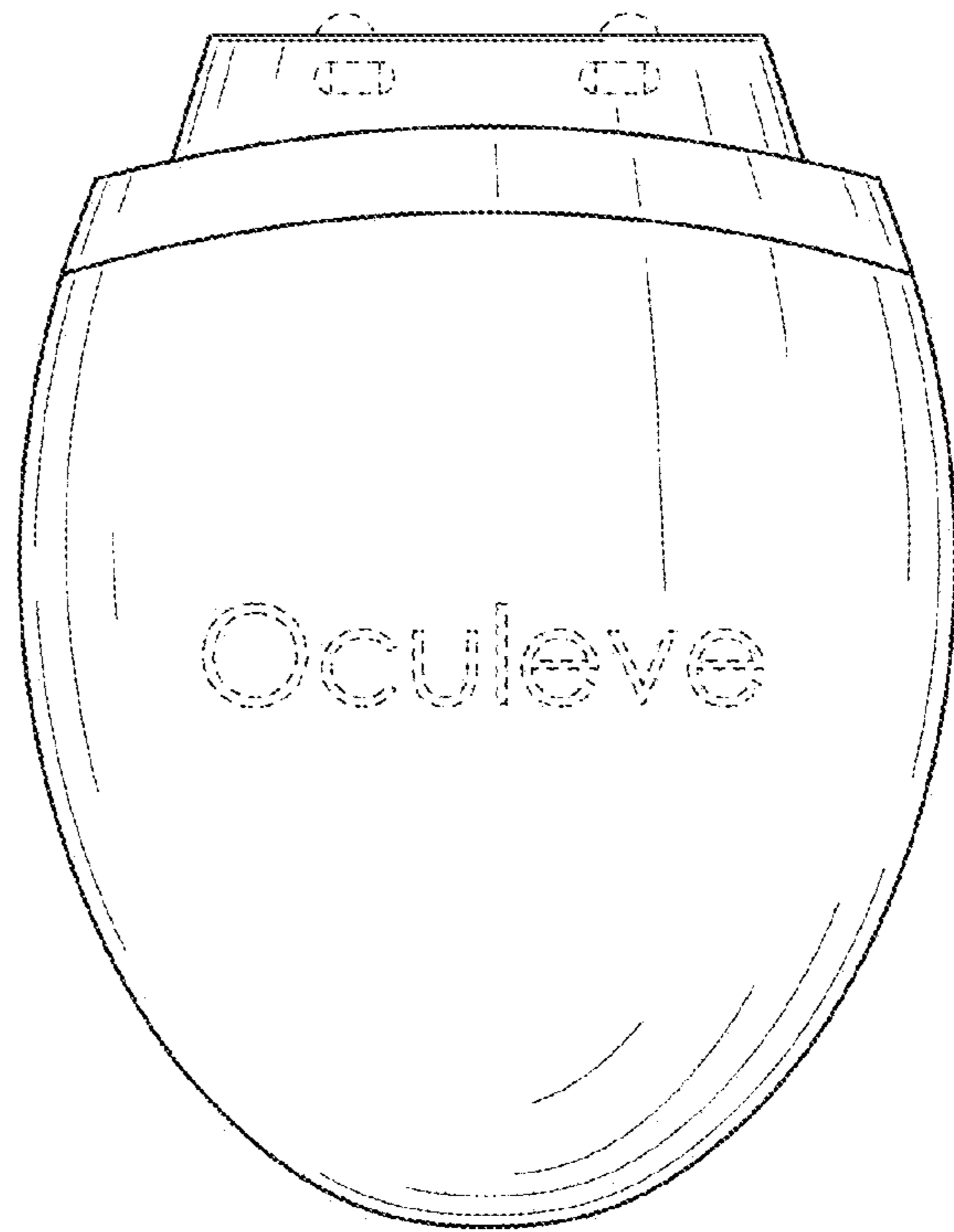

FIG. 24

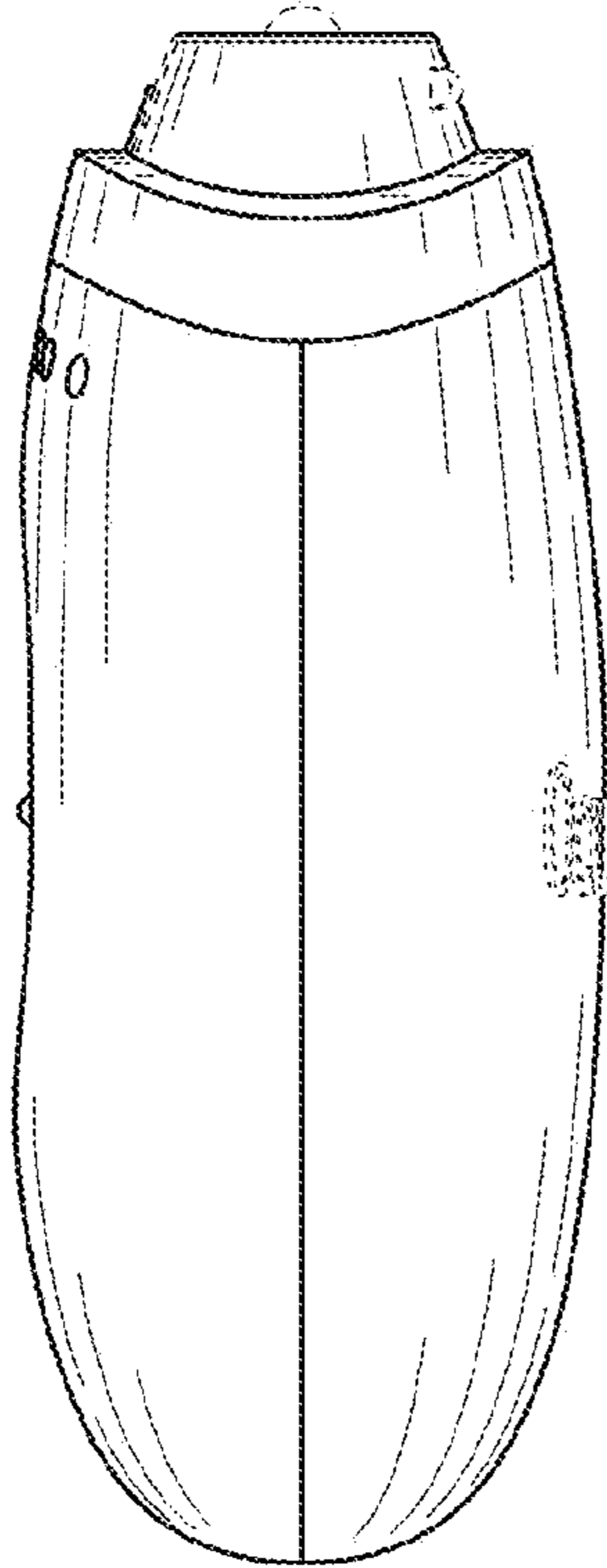

FIG. 25

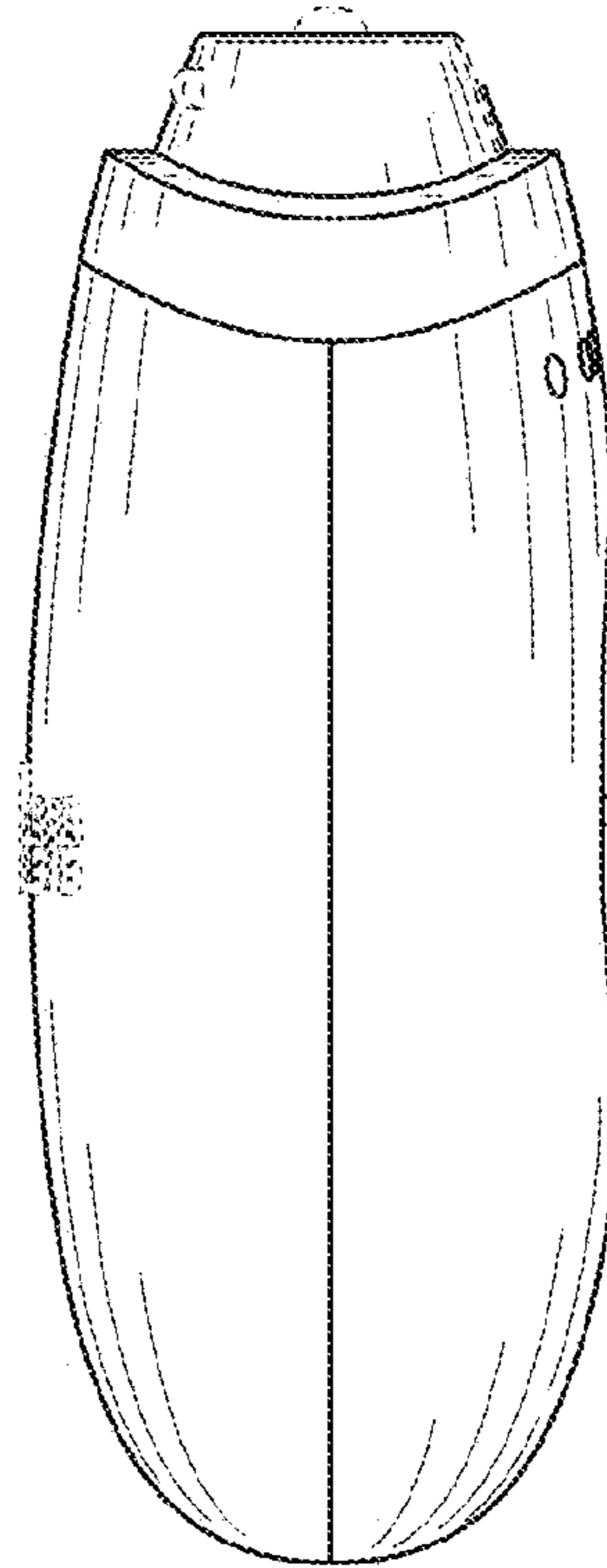

FIG. 26

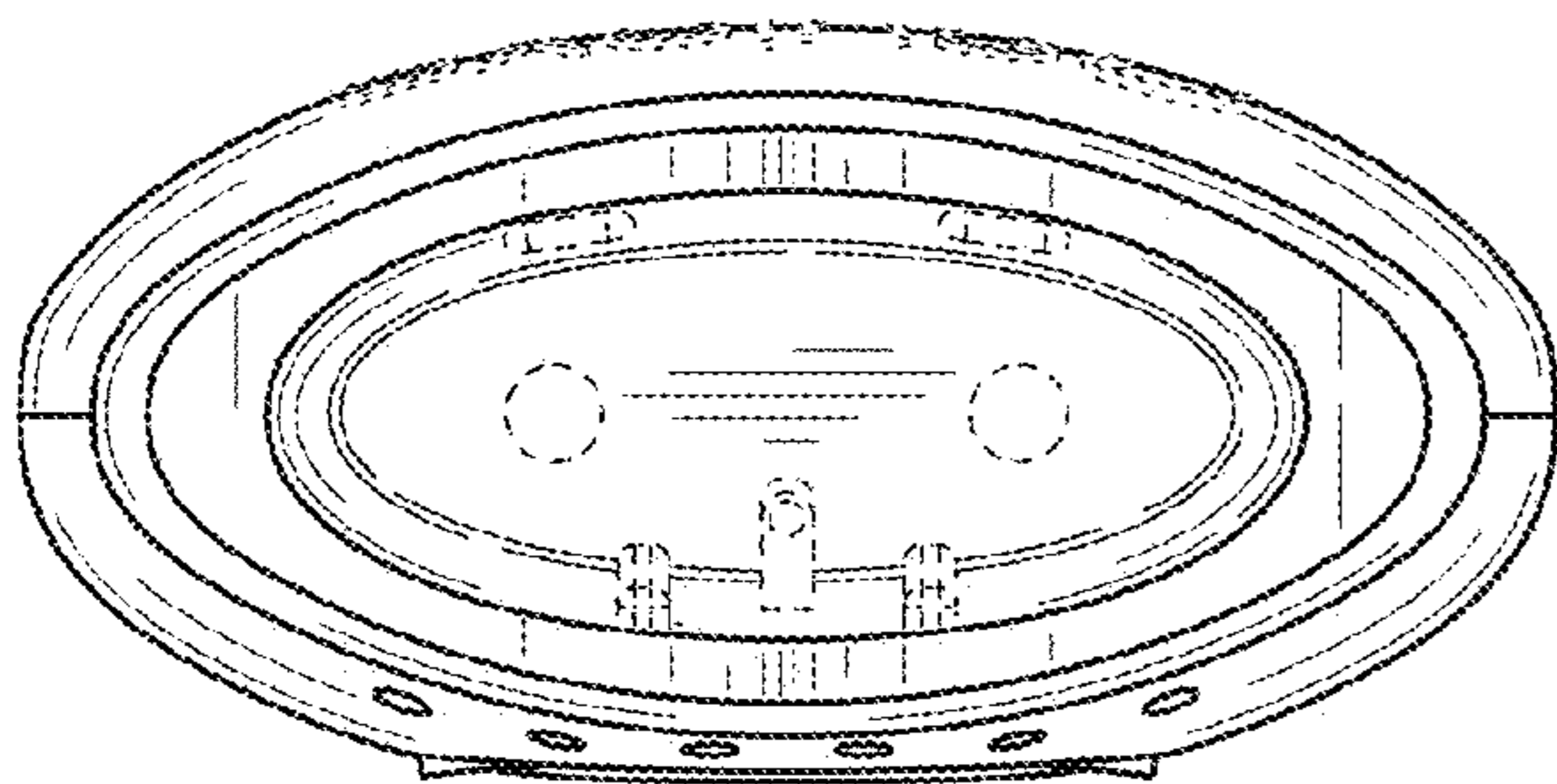

FIG. 27

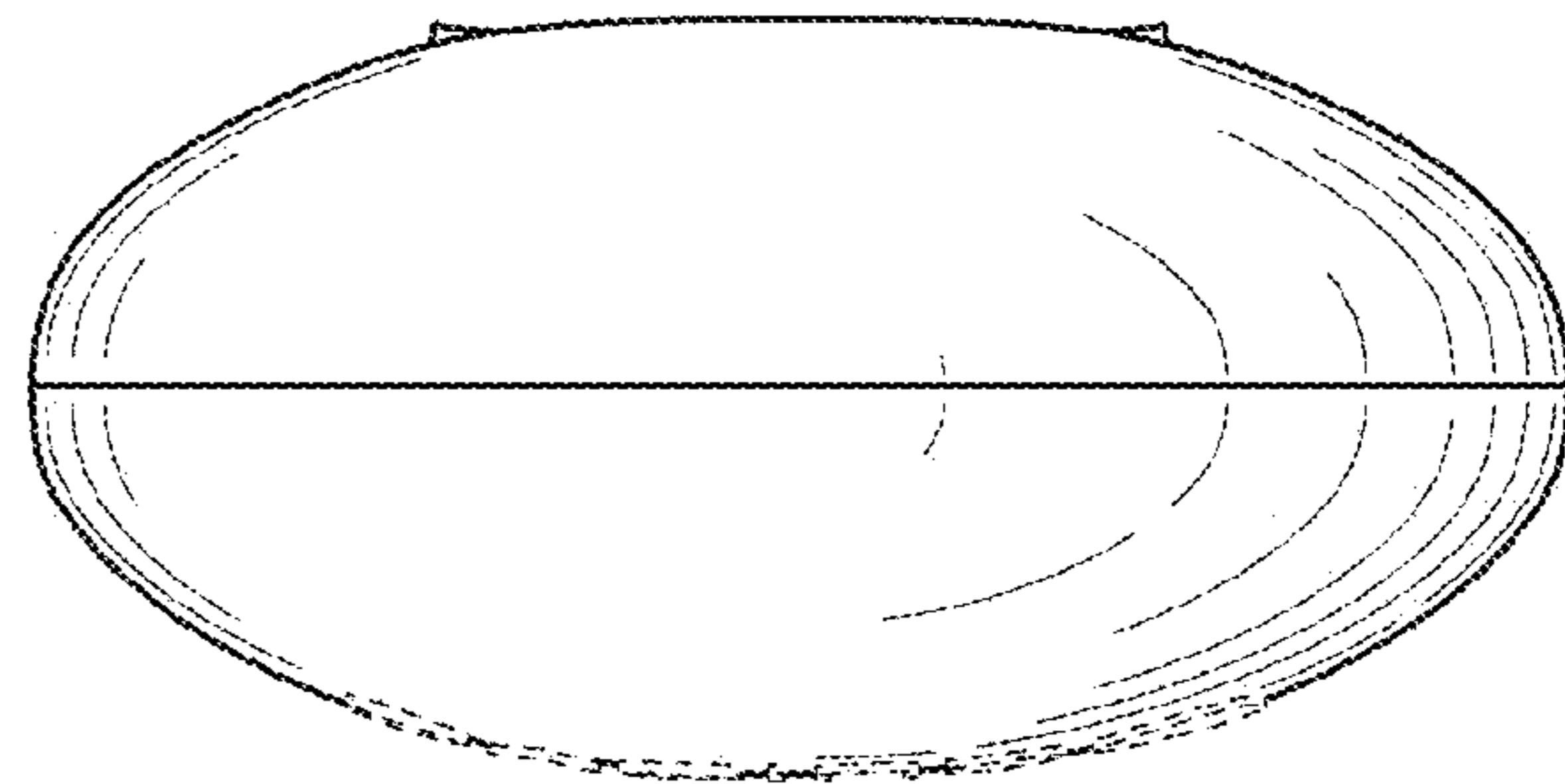

FIG. 28

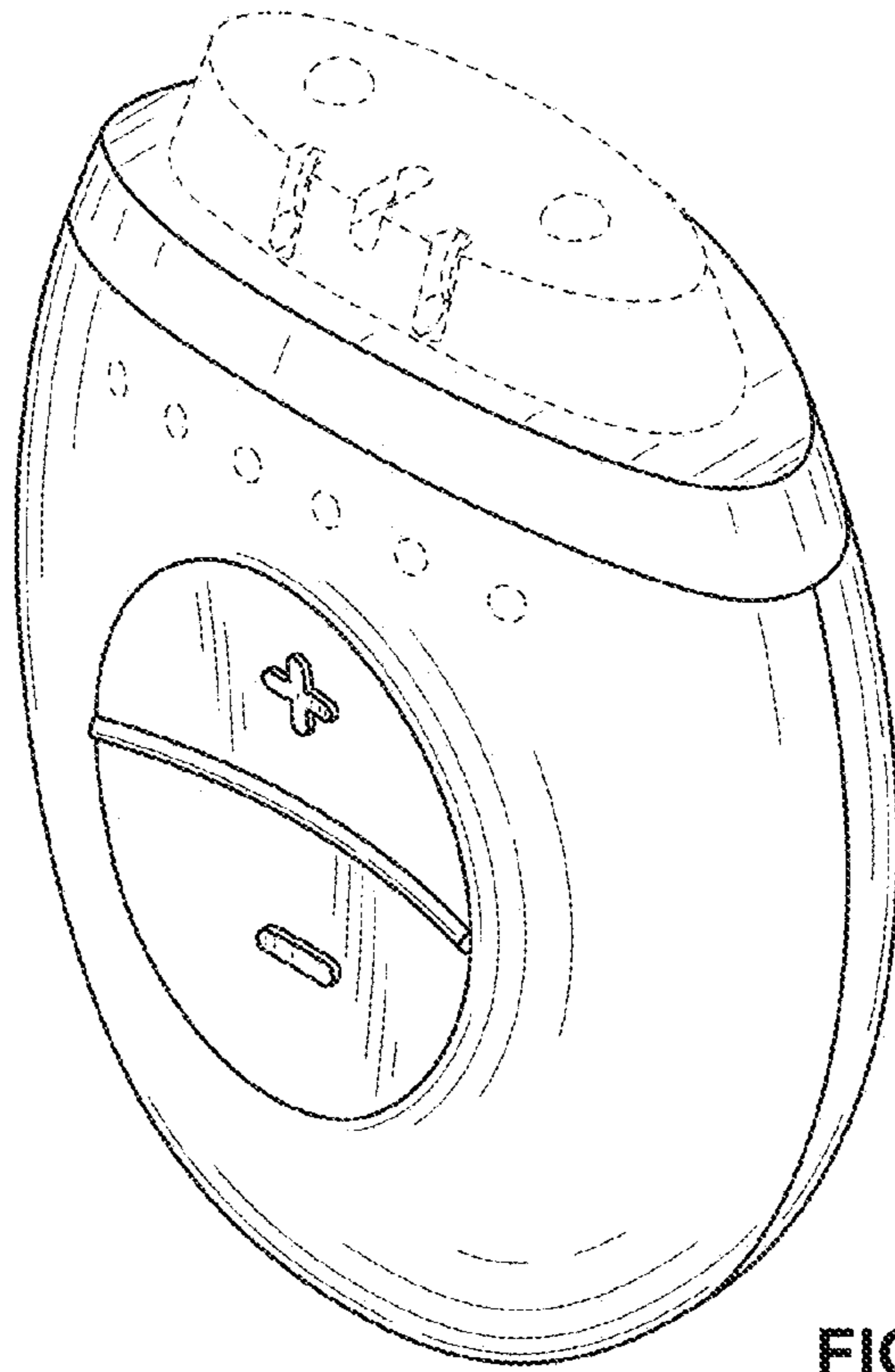

FIG. 29

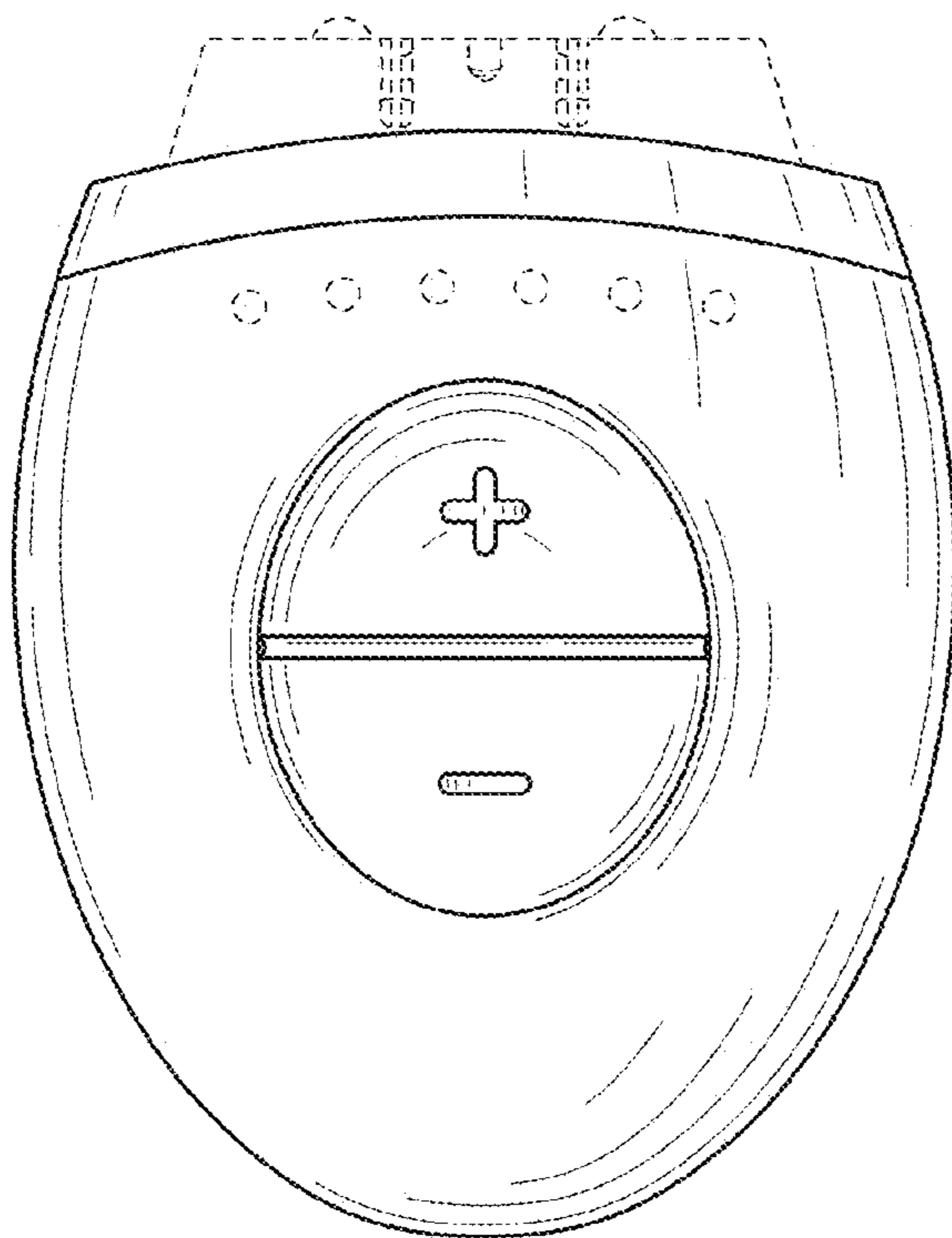

FIG. 30

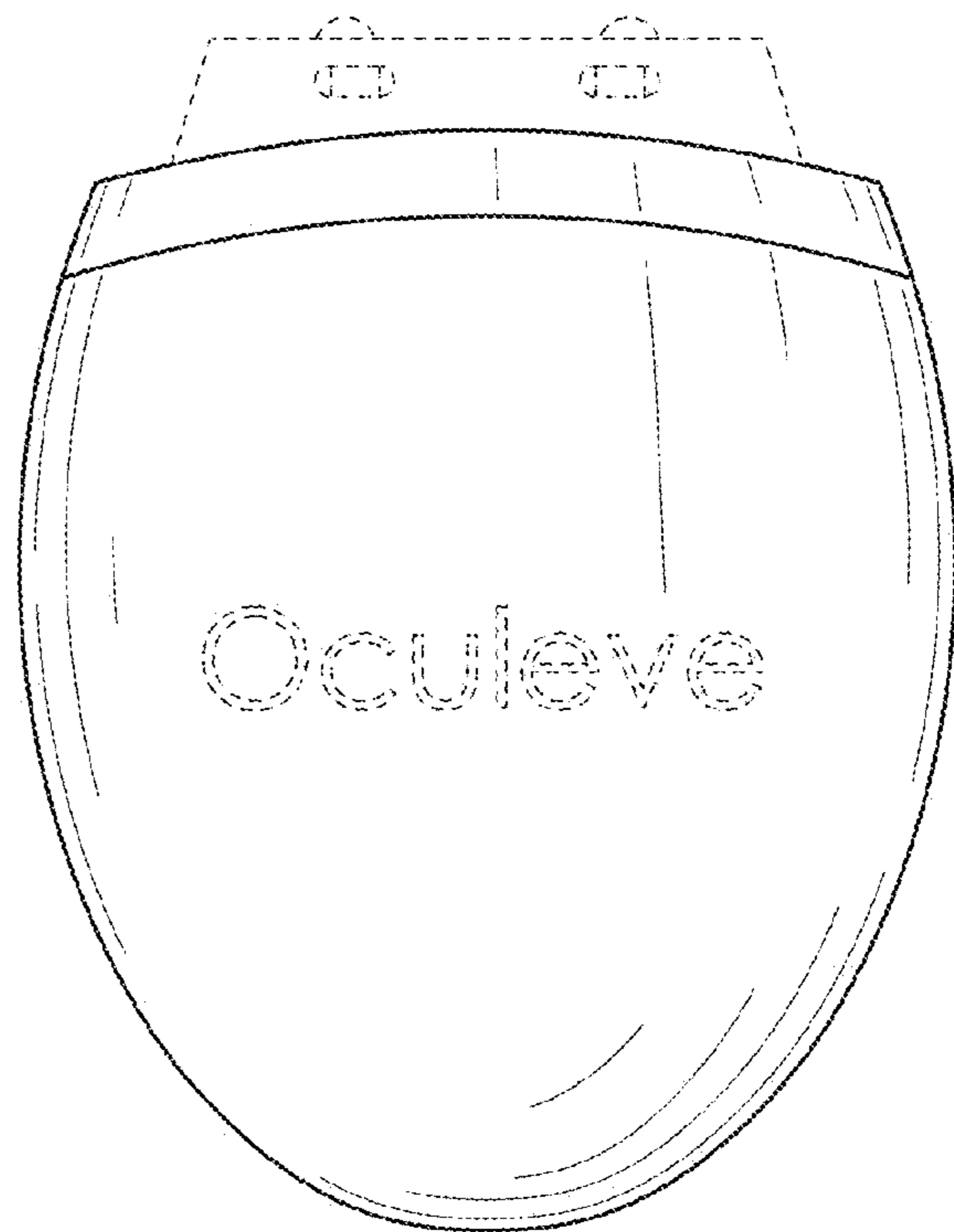

FIG. 31

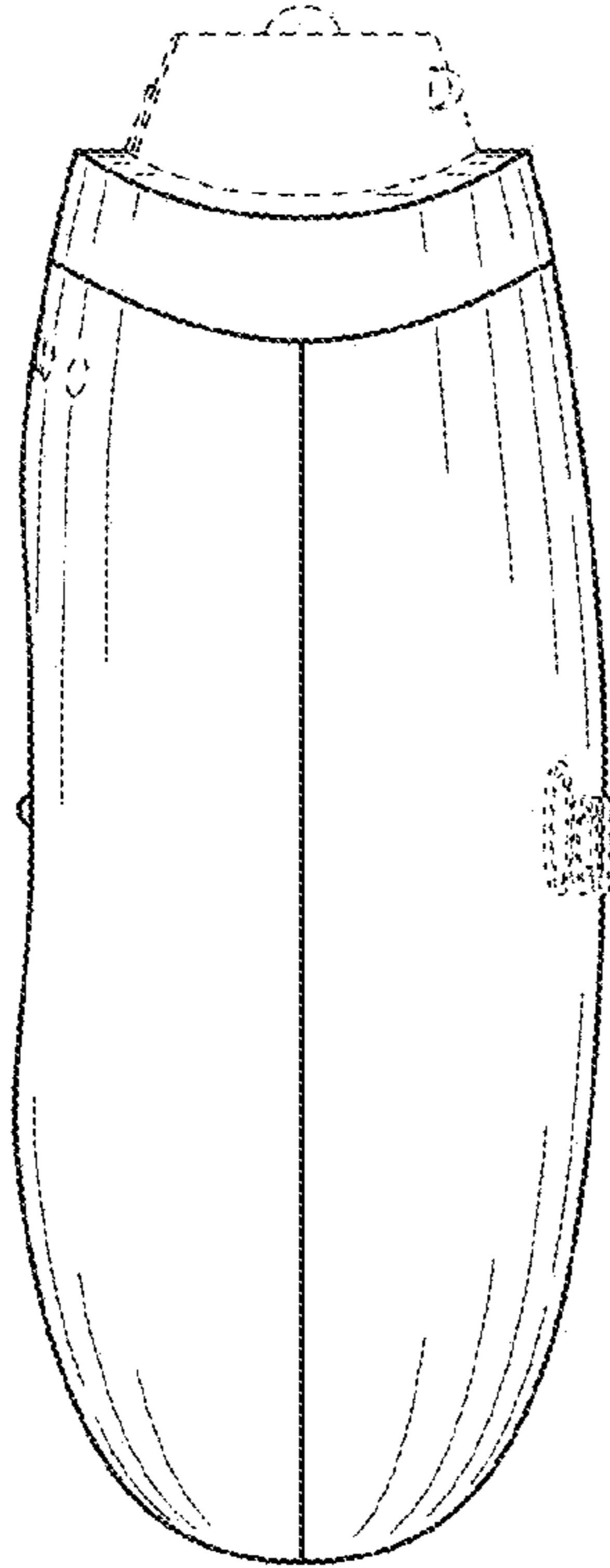

FIG. 32

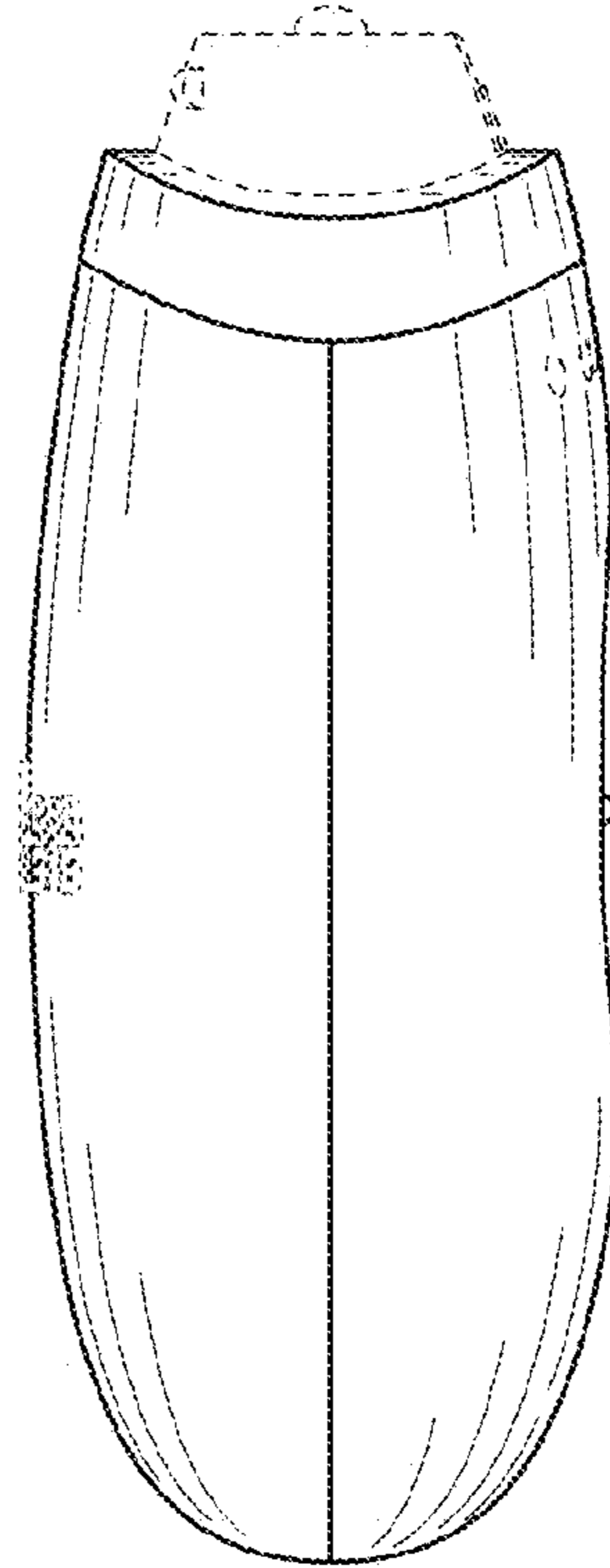

FIG. 33

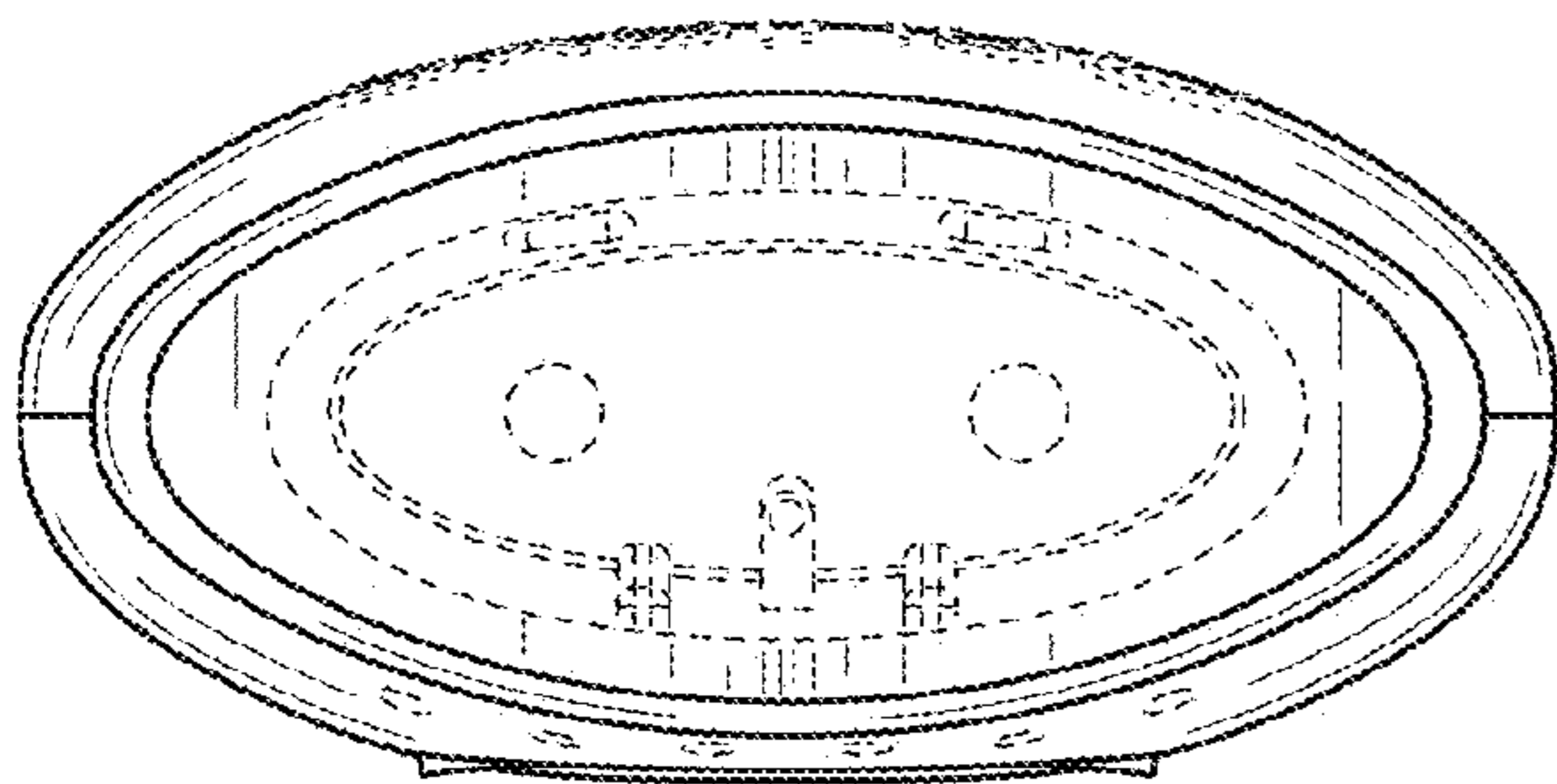

FIG. 34

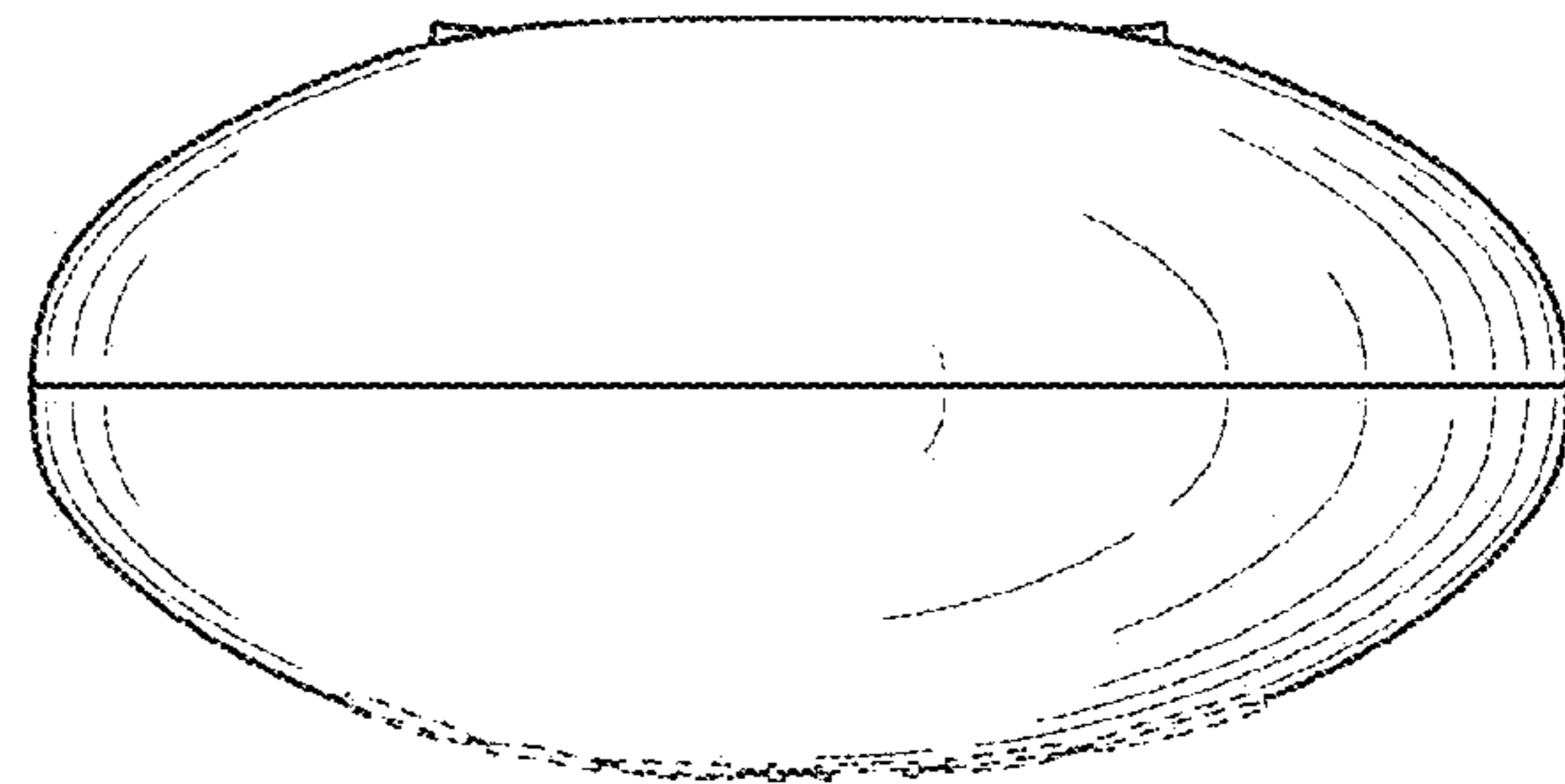

FIG. 35

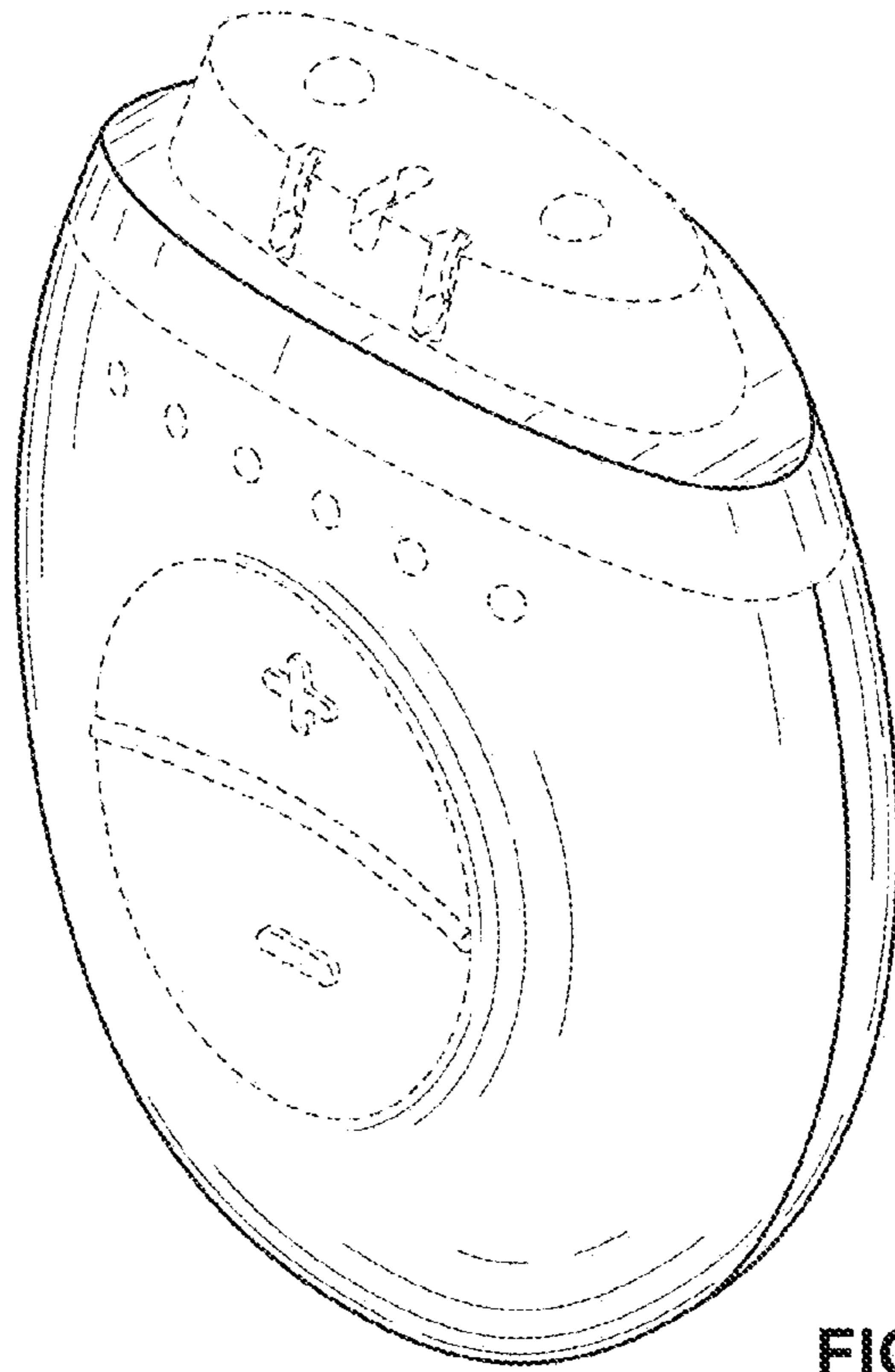

FIG. 36

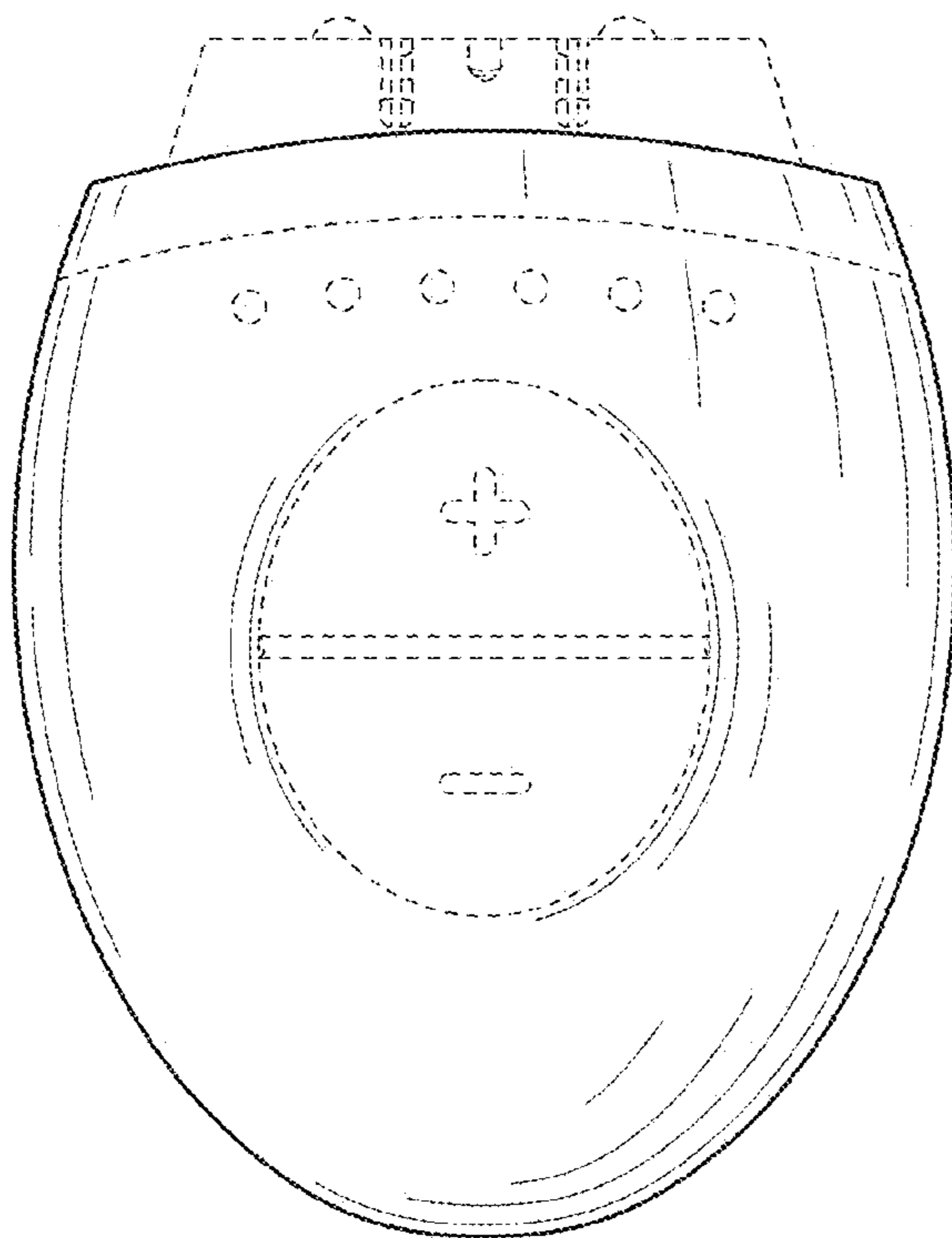

FIG. 37

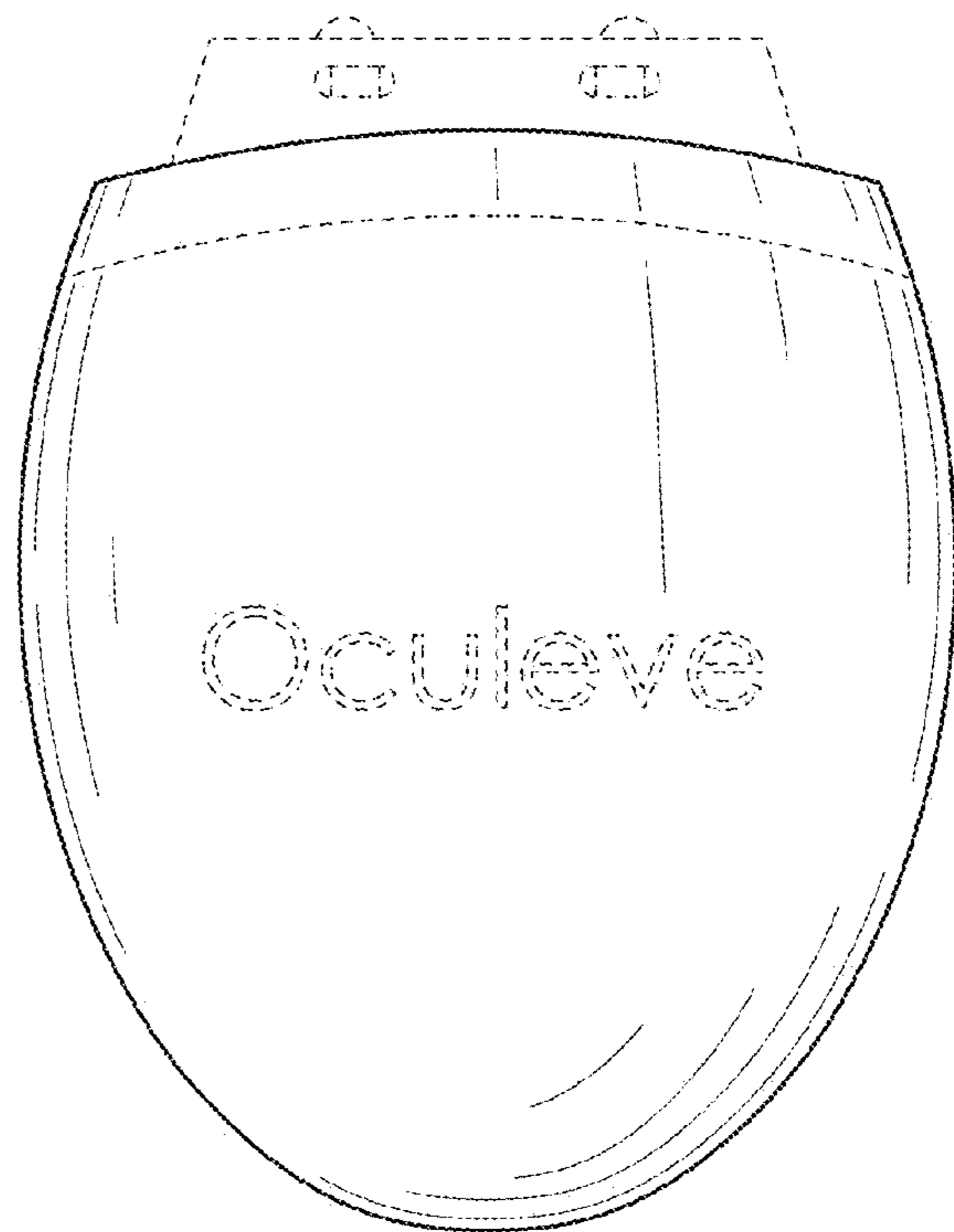

FIG. 38

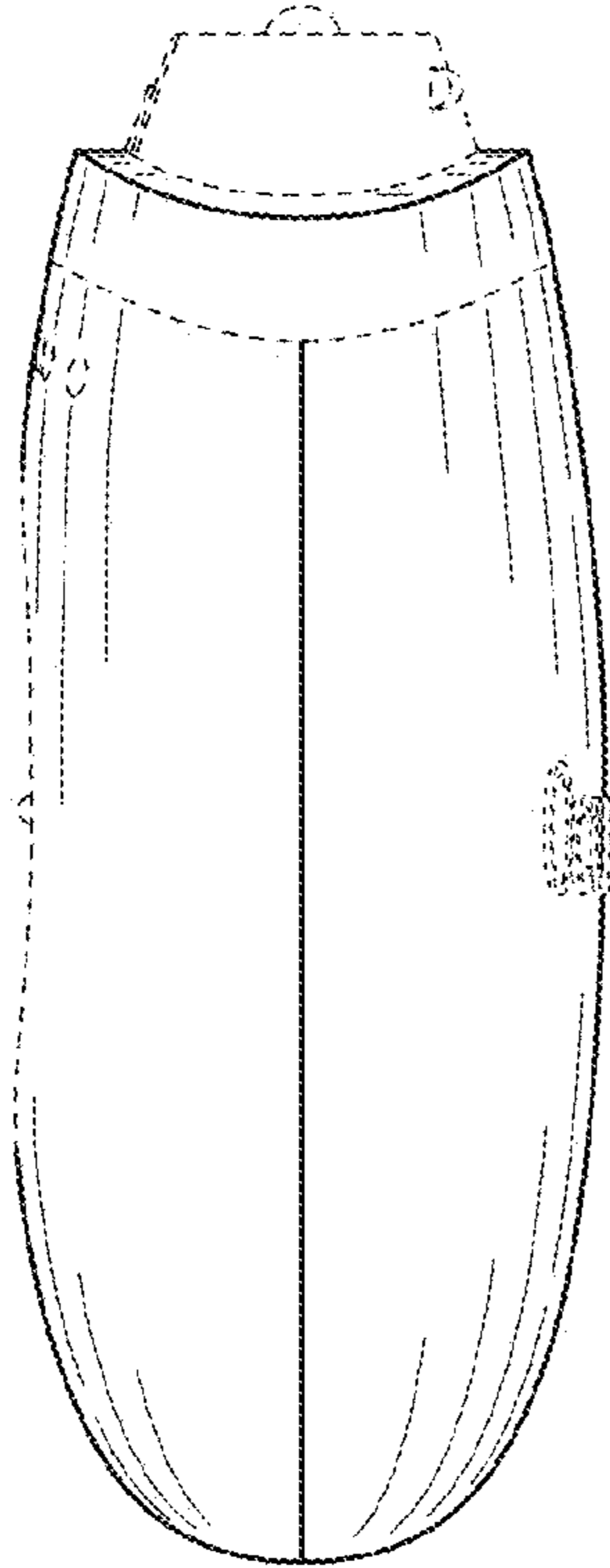

FIG. 39

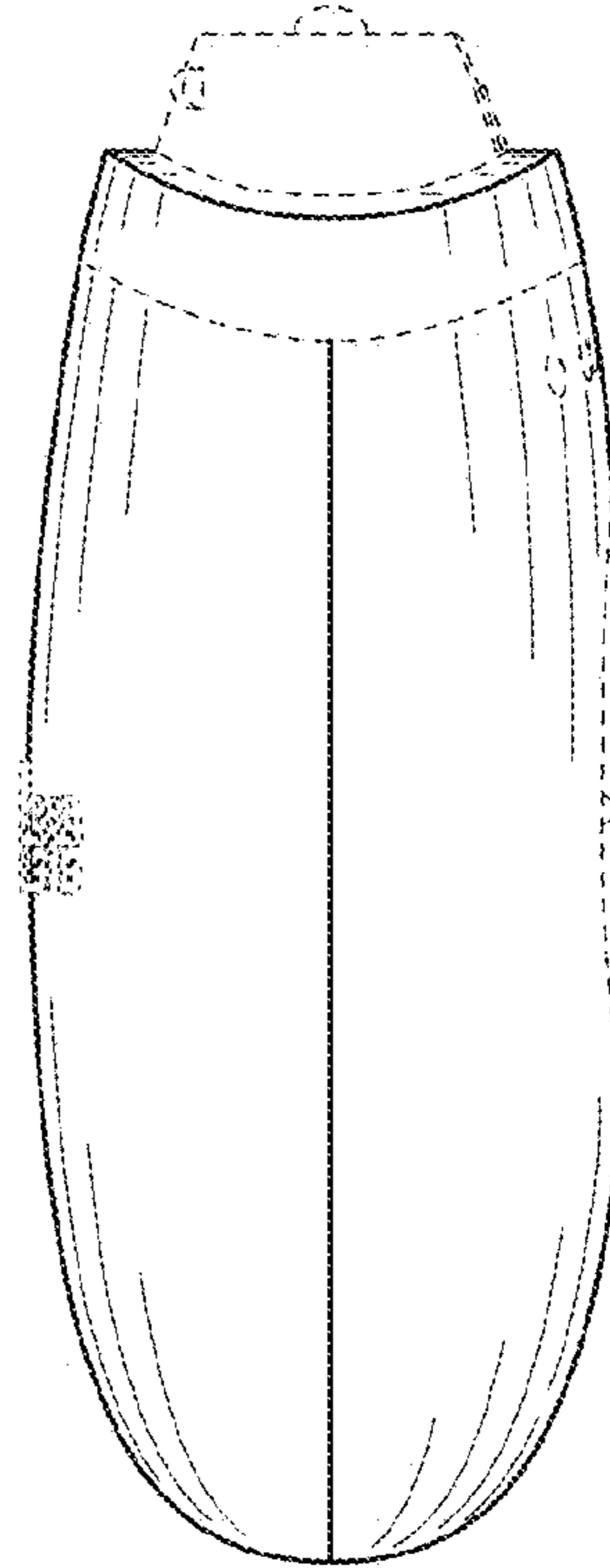

FIG. 40

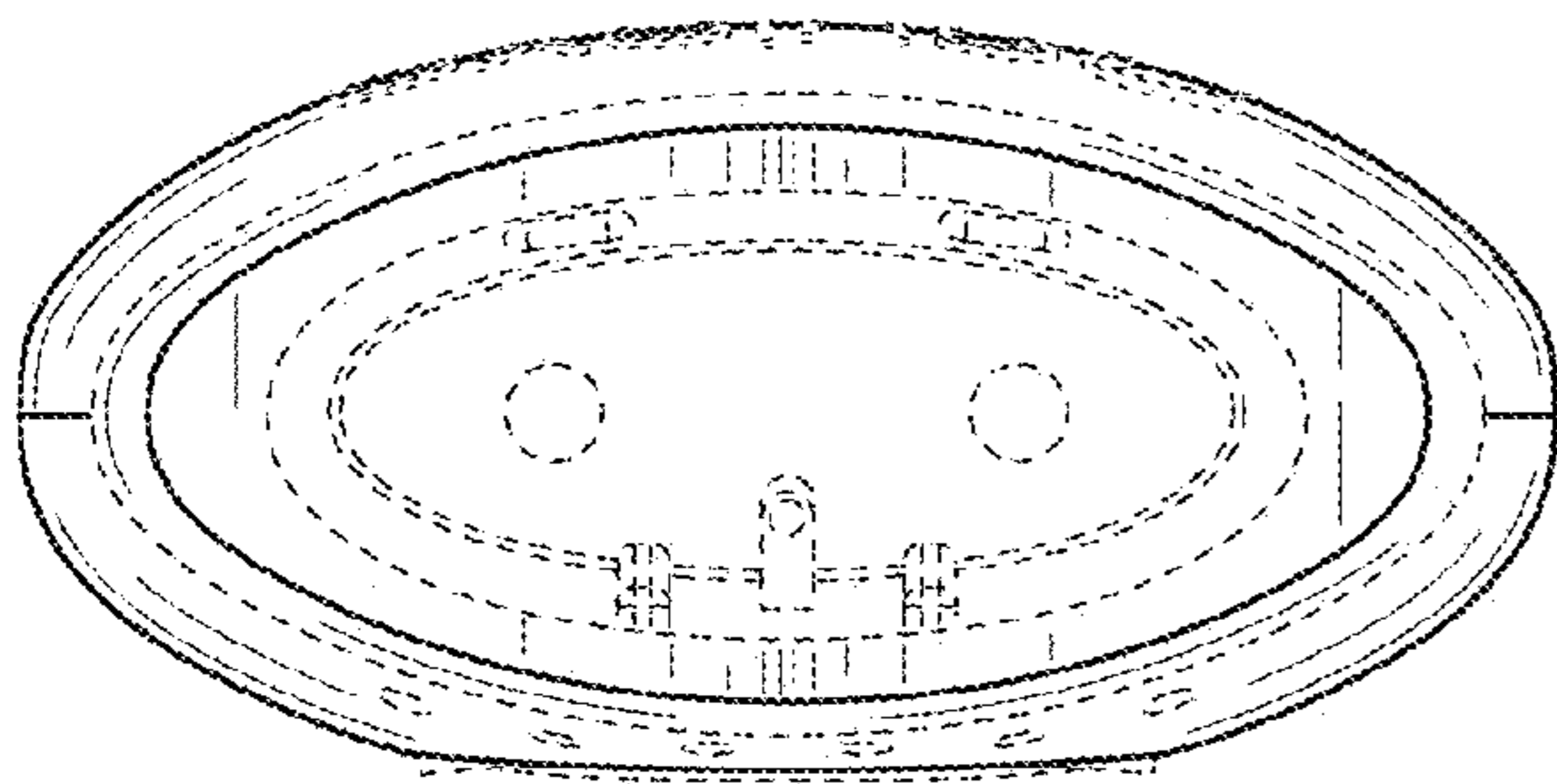

FIG. 41

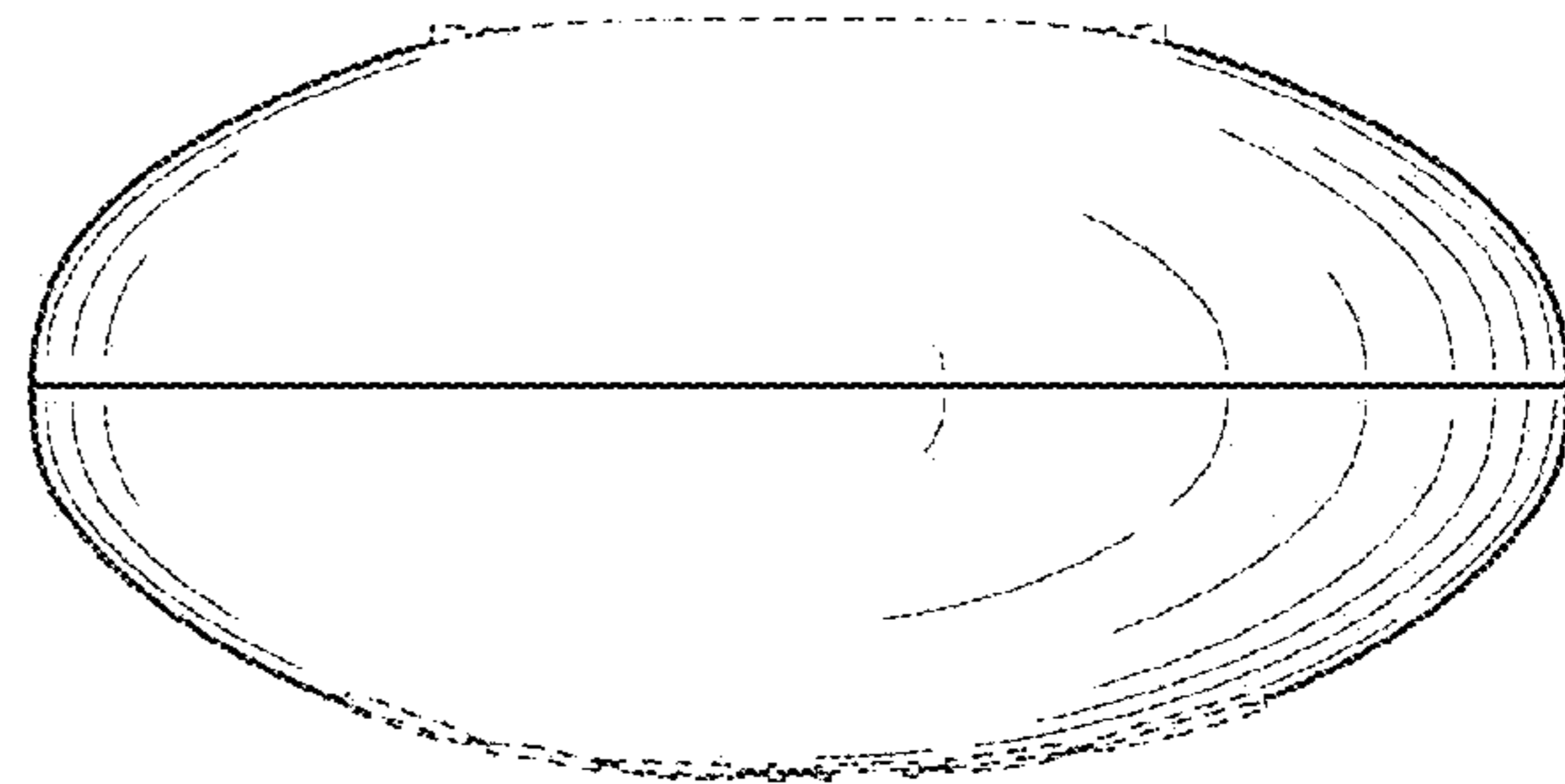

FIG. 42