



US00D907738S

(12) **United States Design Patent**
Fischer

(10) **Patent No.:** **US D907,738 S**
(45) **Date of Patent:** **** Jan. 12, 2021**

(54) **FIREARM HOLSTER SUPPORT**

Primary Examiner — Michael A. Pratt

(71) Applicant: **David John Fischer**, Haymarket, VA
(US)

(72) Inventor: **David John Fischer**, Haymarket, VA
(US)

(**) Term: **15 Years**

(21) Appl. No.: **29/698,410**

(22) Filed: **Jul. 16, 2019**

Related U.S. Application Data

(63) Continuation of application No. 29/664,639, filed on
Sep. 26, 2018, now Pat. No. Des. 855,139.

(51) **LOC (13) Cl.** **22-01**

(52) **U.S. Cl.**
USPC **D22/108; D3/222**

(58) **Field of Classification Search**
USPC **D22/108; D3/222; 224/149–150;**
D8/394–396; 248/229.16, 229.2

(Continued)

(56) **References Cited**

U.S. PATENT DOCUMENTS

2,761,112 A * 8/1956 Torcivia H01R 13/447
174/50
4,154,015 A * 5/1979 Holland A01K 97/10
43/17

(Continued)

FOREIGN PATENT DOCUMENTS

WO WO 2007/045849 A1 4/2007

OTHER PUBLICATIONS

U.S. Patent Application entitled Barrel Held Firearm Carrier U.S.
Appl. No. 16/143,443, filed Sep. 26, 2018.

(Continued)

(57) **CLAIM**

The ornamental design for a firearm holster support, as
shown and described.

DESCRIPTION

FIG. 1 is a top perspective view of a firearm holster support
in accordance with an embodiment of the present design.

FIG. 2 is a top view for the firearm holster support in
accordance with the embodiment of the present design.

FIG. 3 is a bottom view for the firearm holster support in
accordance with the embodiment of the present design.

FIG. 4 is a right side view of the firearm holster support in
accordance with the embodiment of the present design.

FIG. 5 is a left side view for the firearm holster support in
accordance with the embodiment of the present design.

FIG. 6 is a front view for the firearm holster support in
accordance with the embodiment of the present design.

FIG. 7 is a rear view for the firearm holster support in
accordance with the embodiment of the present design; and,

FIG. 8 is a front view of an exemplary firearm holster
suitable for having the firearm holster support attached
thereto according to one embodiment.

The features shown in broken lines in the various figures are
for illustrating environmental structure and form no part of
the claimed design.

The firearm holster support can serve to support a firearm
with respect to a firearm holster. The firearm holster support
can also be referred to as a barrel support member or a barrel
shroud. Additional details on firearm holster and firearm
holster supports are provided in U.S. Patent application Ser.
No. 16/143,443, filed Sep. 26, 2018, and entitled “Barrel
Held Firearm Carrier,” which is hereby incorporated herein
by reference.

The firearm holster support can serve to support a firearm
with respect to a firearm holster. The firearm holster support
can also be referred to as a barrel support member or a barrel
shroud. Additional details on firearm holster and firearm
holster supports are provided in U.S. Patent application Ser.
No. 16/143,443, filed Sep. 26, 2018, and entitled “Barrel
Held Firearm Carrier,” which is hereby incorporated herein
by reference.

The firearm holster support can serve to support a firearm
with respect to a firearm holster. The firearm holster support
can also be referred to as a barrel support member or a barrel
shroud. Additional details on firearm holster and firearm
holster supports are provided in U.S. Patent application Ser.
No. 16/143,443, filed Sep. 26, 2018, and entitled “Barrel
Held Firearm Carrier,” which is hereby incorporated herein
by reference.

The firearm holster support can serve to support a firearm
with respect to a firearm holster. The firearm holster support
can also be referred to as a barrel support member or a barrel
shroud. Additional details on firearm holster and firearm
holster supports are provided in U.S. Patent application Ser.
No. 16/143,443, filed Sep. 26, 2018, and entitled “Barrel
Held Firearm Carrier,” which is hereby incorporated herein
by reference.

The firearm holster support can serve to support a firearm
with respect to a firearm holster. The firearm holster support
can also be referred to as a barrel support member or a barrel
shroud. Additional details on firearm holster and firearm
holster supports are provided in U.S. Patent application Ser.
No. 16/143,443, filed Sep. 26, 2018, and entitled “Barrel
Held Firearm Carrier,” which is hereby incorporated herein
by reference.

The firearm holster support can serve to support a firearm
with respect to a firearm holster. The firearm holster support
can also be referred to as a barrel support member or a barrel
shroud. Additional details on firearm holster and firearm
holster supports are provided in U.S. Patent application Ser.
No. 16/143,443, filed Sep. 26, 2018, and entitled “Barrel
Held Firearm Carrier,” which is hereby incorporated herein
by reference.

1 Claim, 5 Drawing Sheets

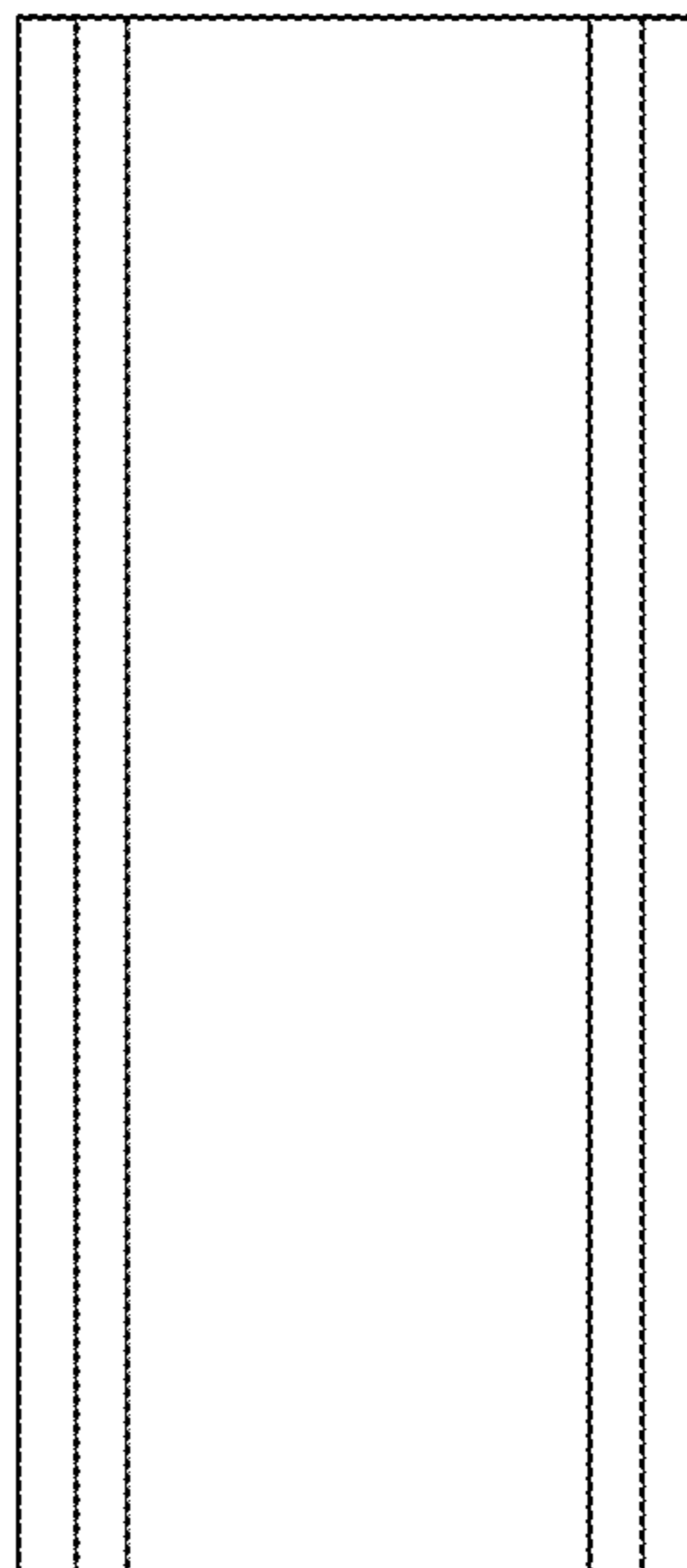

(58) **Field of Classification Search**
 CPC F41C 33/046; F41C 33/007
 See application file for complete search history.

(56) **References Cited**

U.S. PATENT DOCUMENTS

D325,300 S	4/1992	Miklus, II	
5,184,797 A *	2/1993	Hurner	A01K 97/10 248/515
D378,398 S *	3/1997	Osburn	D22/147
D407,137 S *	3/1999	Thompson	D22/147
6,755,331 B2	6/2004	Rassias	
7,258,259 B1	8/2007	Owens	
D605,851 S *	12/2009	Drake	D22/147
D752,176 S *	3/2016	Johns	D22/147
9,914,655 B2	3/2018	Oinuma et al.	
2002/0002791 A1 *	1/2002	Thompson	A01K 97/08 43/21.2
2007/0185457 A1 *	8/2007	Euteneuer	A61B 17/22032 604/170.02
2007/0292647 A1 *	12/2007	Princell	B29C 65/5021 428/36.9
2009/0000137 A1 *	1/2009	Diaz	E04B 1/4157 33/562

2009/0025942 A1 *	1/2009	Hall	E21B 7/068 166/381
2010/0314423 A1	12/2010	Kawamoto et al.	
2012/0172153 A1 *	7/2012	Newman	A63B 69/0075 473/417
2012/0210793 A1 *	8/2012	Daton-Lovett	E21B 47/0001 73/570
2016/0033059 A1 *	2/2016	Fonte	C22F 1/183 138/171
2016/0113370 A1 *	4/2016	Arel, Jr.	A45C 15/00 220/592.09
2016/0210955 A1 *	7/2016	Lagarrigue	G10K 11/172
2016/0363488 A1 *	12/2016	Sipila	G01L 3/102
2019/0001783 A1 *	1/2019	Garcia	B60G 17/08

OTHER PUBLICATIONS

“Mossberg 500 Just In Case,” O.F. Mossberg & Sons, Inc., 2018, downloaded from <http://www.mossberg.com/category/series/500-jic>.
 “Voodoo Tactical Breachers Shotgun Scabbard,” www.opticsplanet.com, 2018, downloaded from <https://www.opticsplanet.com/voodoo-tactical-breaches-shotgun-scabbard.html>.

* cited by examiner

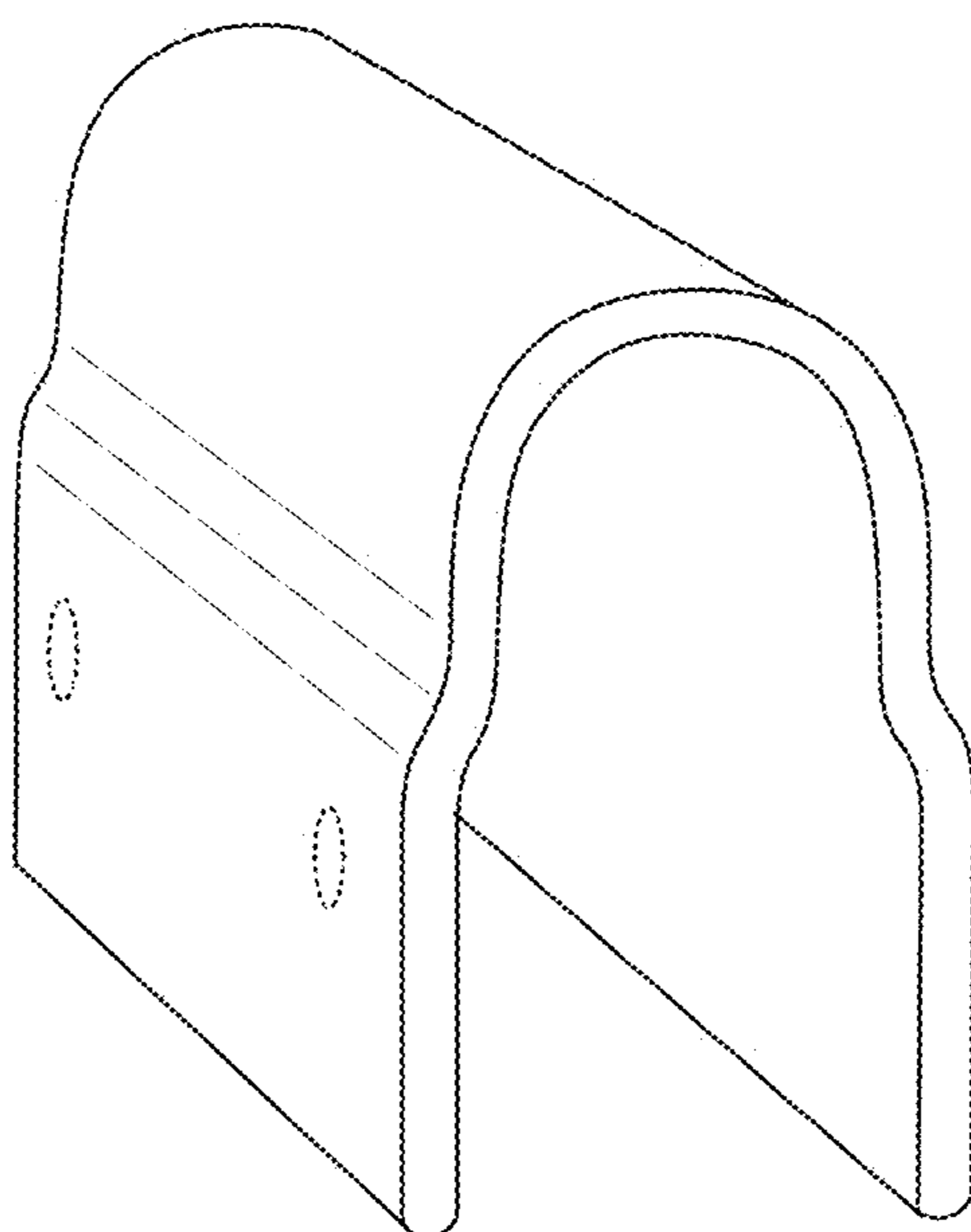

FIG. 1

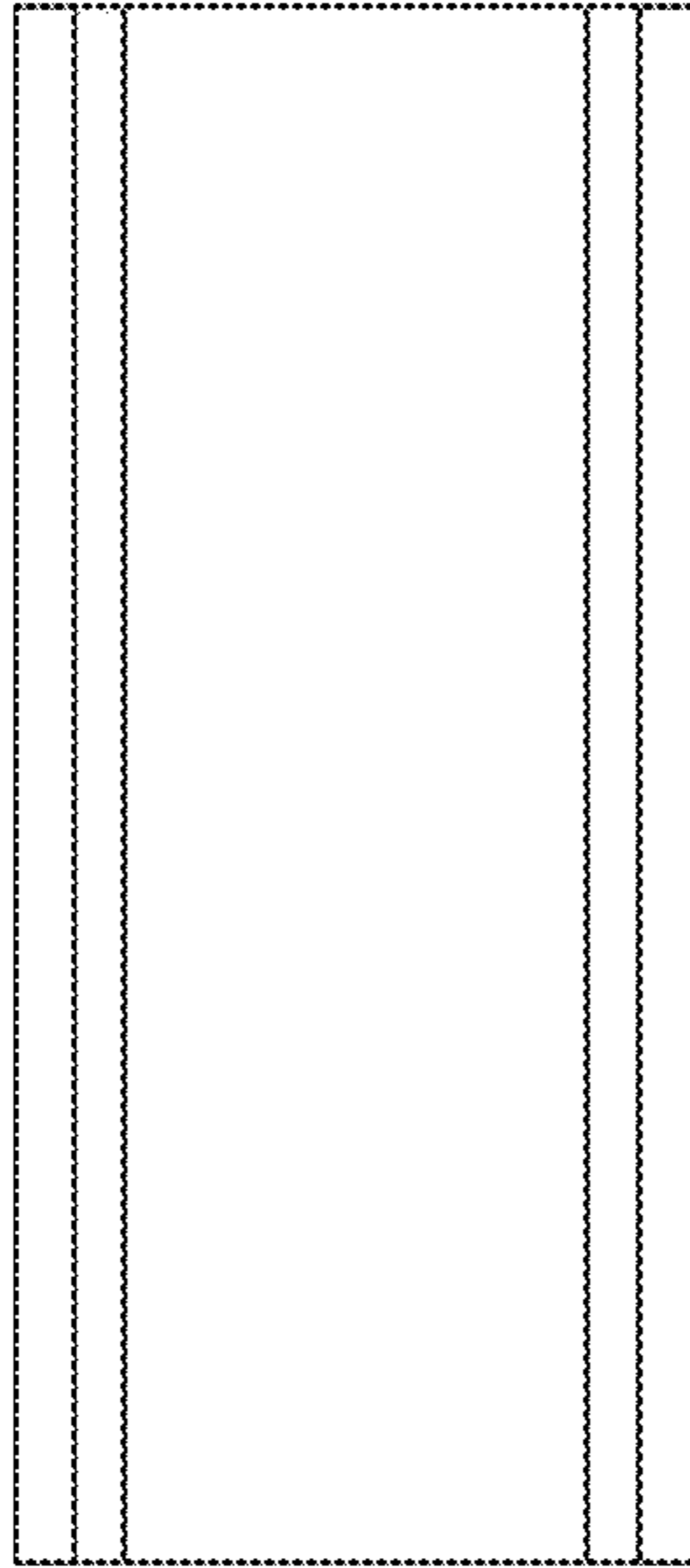

FIG. 2

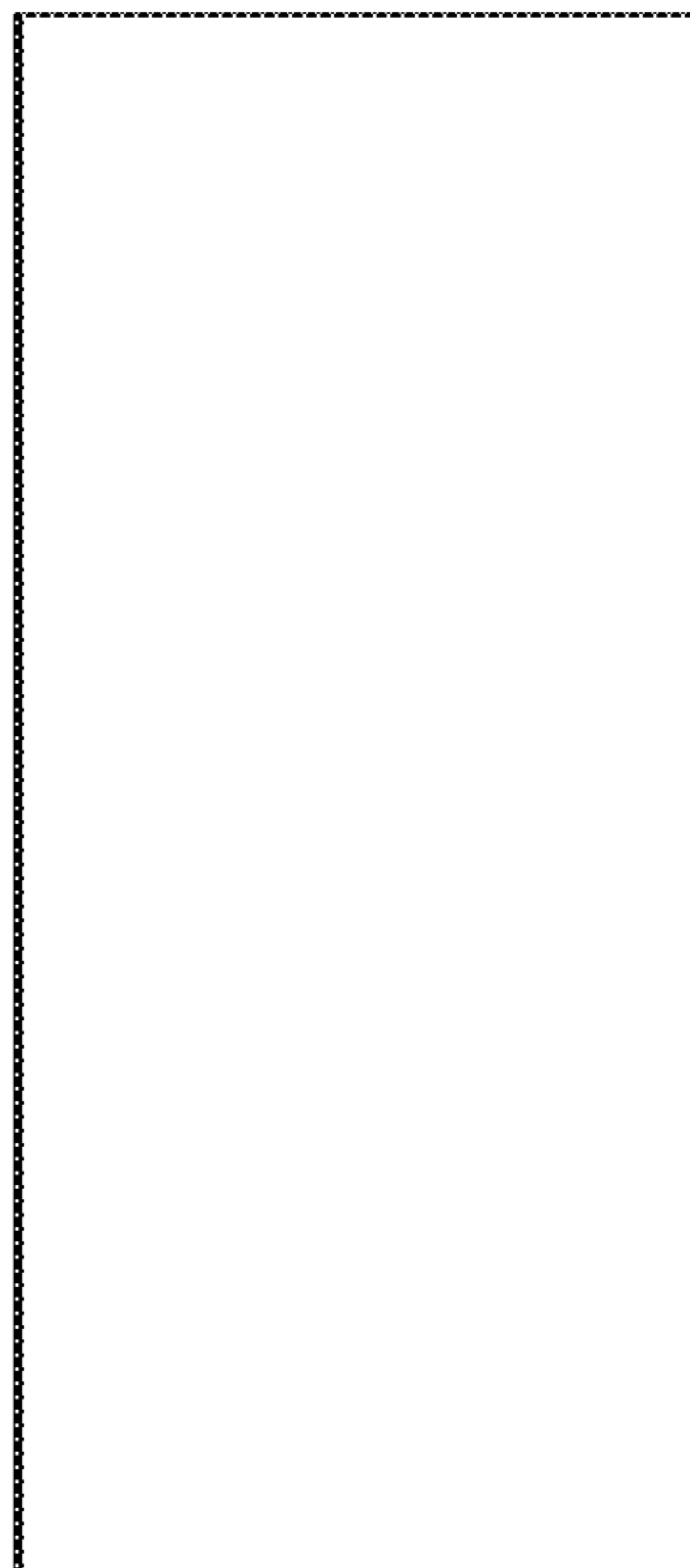

FIG. 3

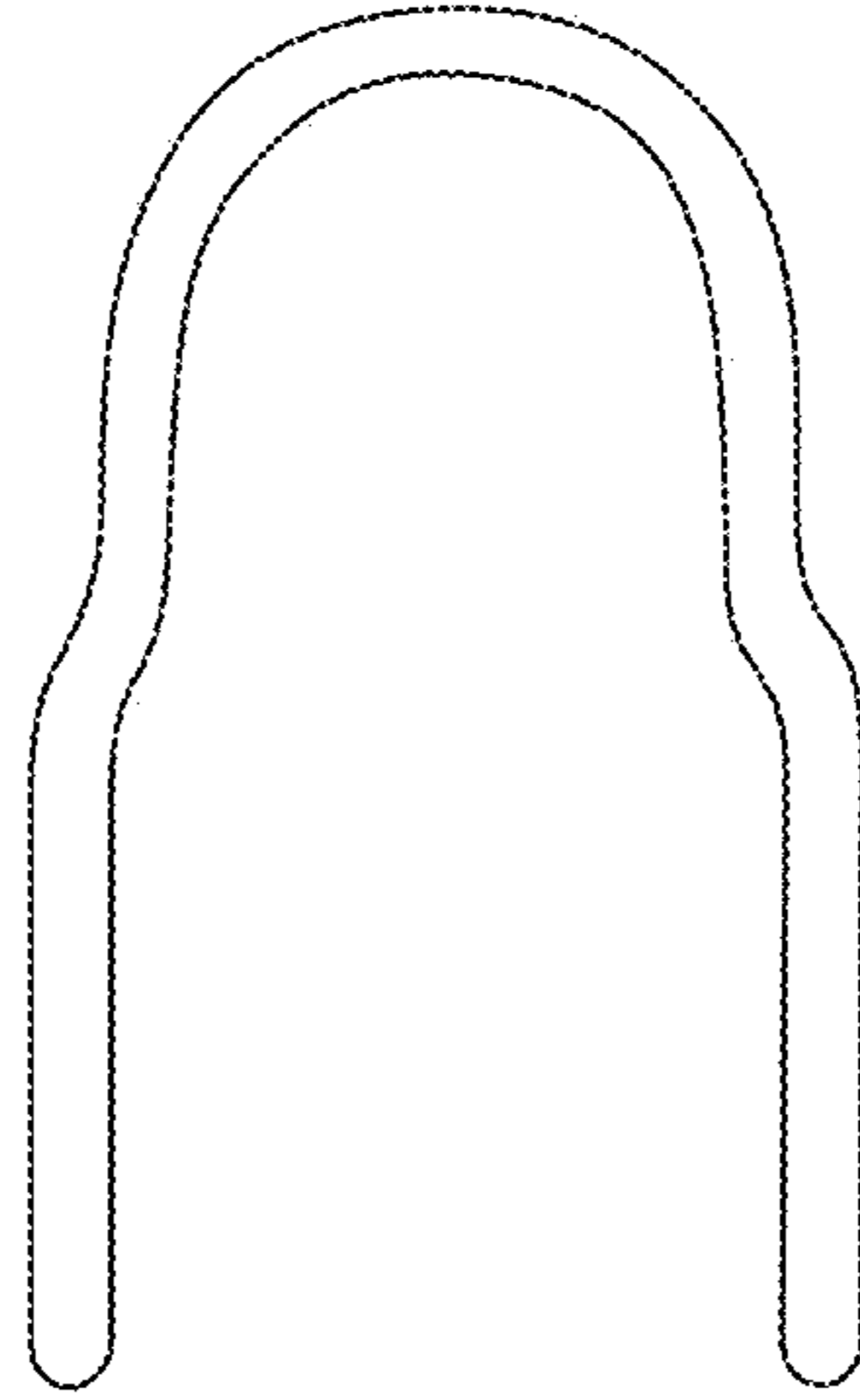

FIG. 4

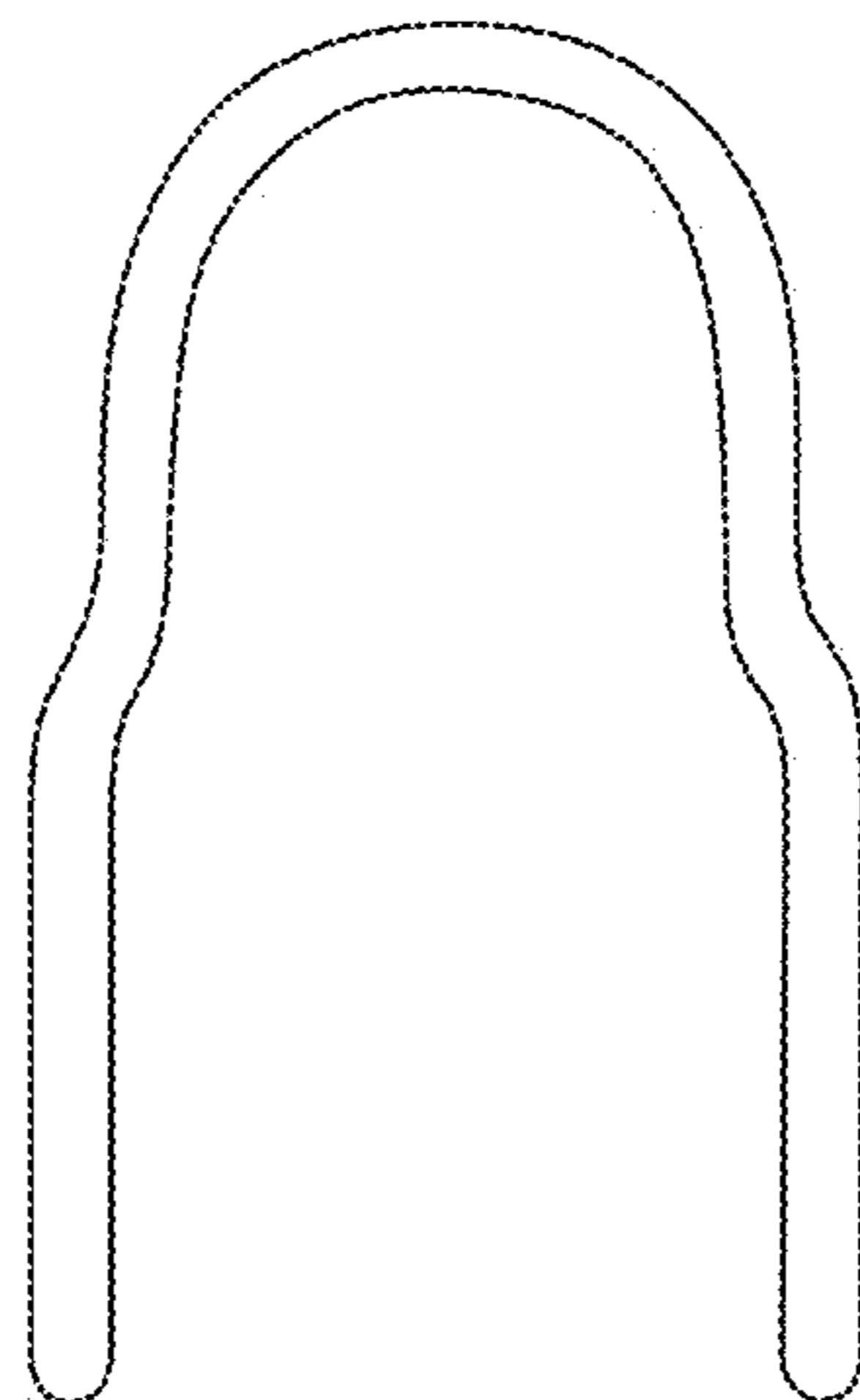

FIG. 5

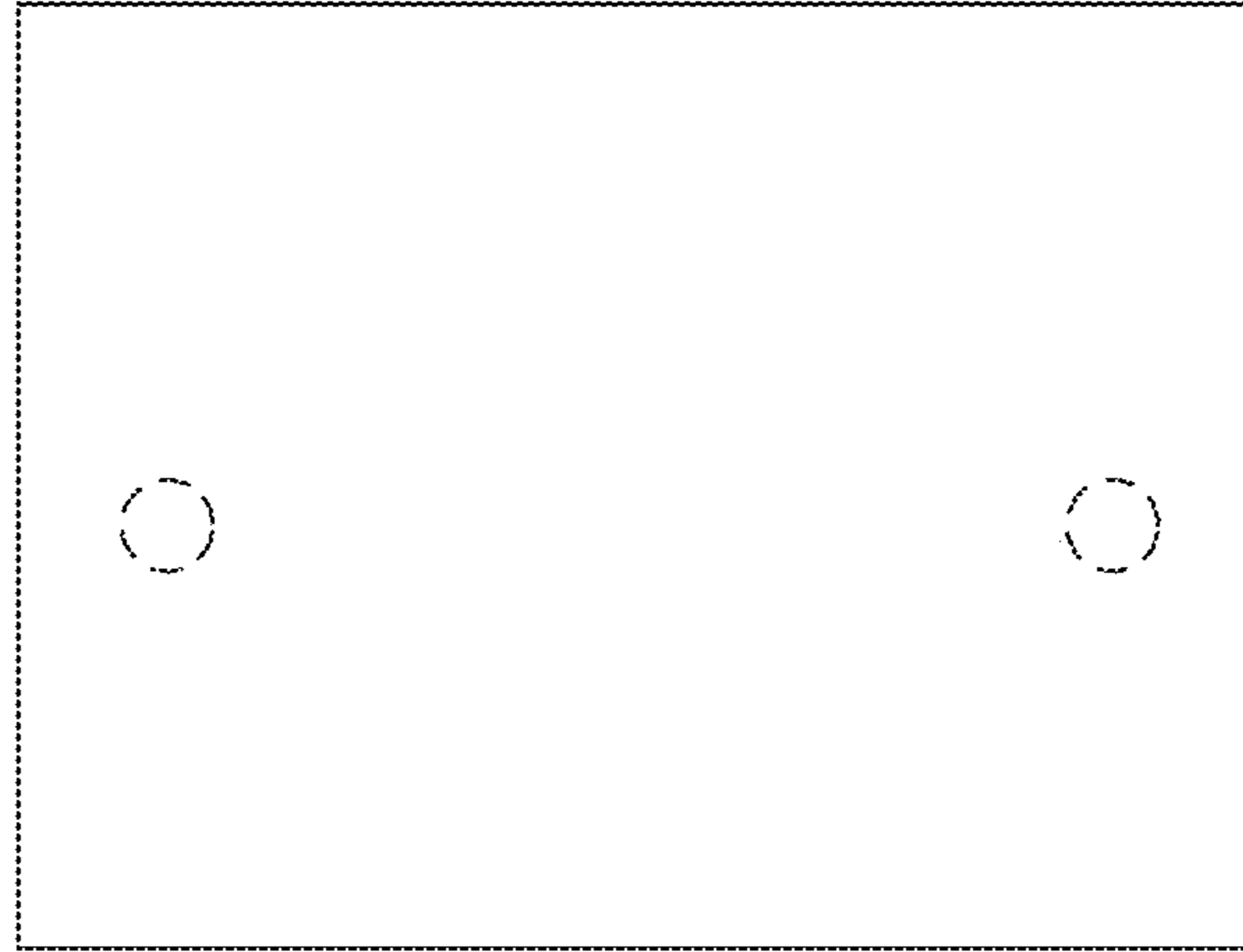

FIG. 6



FIG. 7

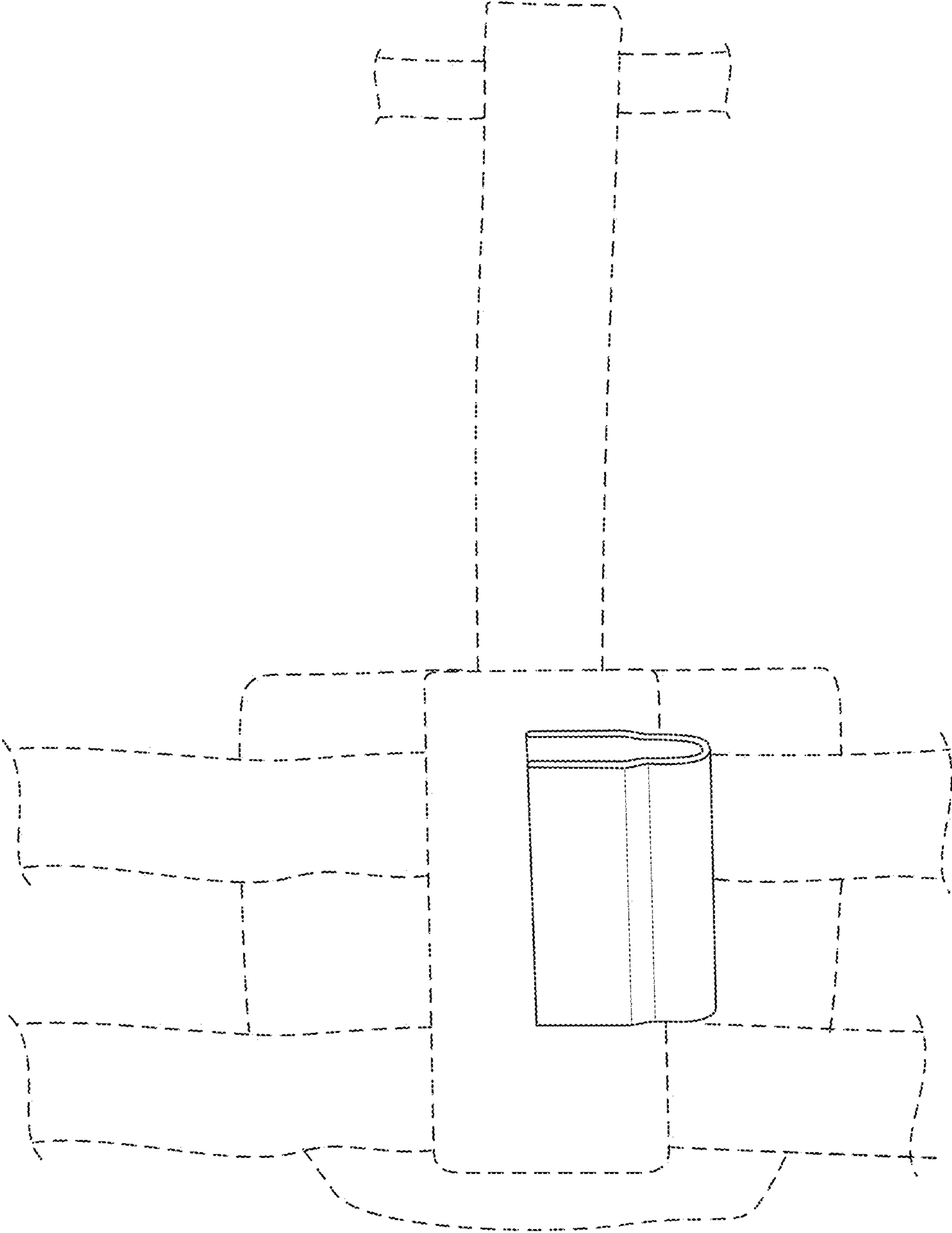

FIG. 8