



US00D907723S

(12) **United States Design Patent** (10) **Patent No.:** **US D907,723 S**
Barton et al. (45) **Date of Patent:** **** Jan. 12, 2021**

(54) **PAIR OF SPACED-APART EXERCISE HANDLES**

(71) Applicant: **Barton Innovations, LLC**,
Waynesfield, OH (US)

(72) Inventors: **Thomas Jeffrey Barton**, Waynesfield,
OH (US); **David Joseph Barton**,
Waynesfield, OH (US); **Sara Anne
Barton**, Waynesfield, OH (US)

(73) Assignee: **Barton Innovations, LLC**,
Waynesfield, OH (US)

(**) Term: **15 Years**

(21) Appl. No.: **29/666,541**

(22) Filed: **Oct. 14, 2018**

Related U.S. Application Data

(63) Continuation-in-part of application No. 29/571,569,
filed on Jul. 19, 2016, now abandoned.

(51) **LOC (13) Cl.** **21-02**

(52) **U.S. Cl.**
USPC **D21/694**

(58) **Field of Classification Search**
USPC D21/673, 679, 682, 694, 662, 684, 686,
D21/691; 482/139, 93, 98, 38, 39, 108,
482/40, 148, 904; D32/35, 50; D8/45,
D8/316
CPC ... A63B 21/4035; A63B 1/00; A63B 21/4017;
A63B 23/1218; A63B 21/072; A63B
21/0724
See application file for complete search history.

(56) **References Cited**

U.S. PATENT DOCUMENTS

D226,151 S * 1/1973 Pawsat D12/178
3,837,642 A * 9/1974 Martin A63B 21/068
482/38
D262,730 S * 1/1982 Lambert, Jr. D21/694

(Continued)

OTHER PUBLICATIONS

Products by MAG dated no date given. Found online [Apr. 29,
2020] <https://www.maxagrip.com/products/>.*

(Continued)

Primary Examiner — Ryan Harvey
(74) *Attorney, Agent, or Firm* — The Law Office of
Patrick F. O'Reilly III, LLC

(57) **CLAIM**

The ornamental design for a pair of spaced-apart exercise
handles, as shown and described.

DESCRIPTION

FIG. 1 is a bottom-front perspective view of an embodiment
of a pair of spaced-apart exercise handles showing our new
design;

FIG. 2 is a rear-bottom perspective view of the embodiment
shown in FIG. 1;

FIG. 3 is a front elevational view of the embodiment shown
in FIG. 1;

FIG. 4 is a rear elevational view of the embodiment shown
in FIG. 1;

FIG. 5 is a bottom plan view of the embodiment shown in
FIG. 1;

FIG. 6 is a top plan view of the embodiment shown in FIG.
1;

FIG. 7 is a right side elevational view of the embodiment
shown in FIG. 1; and,

FIG. 8 is a left side elevational view of the embodiment
shown in FIG. 1.

The broken line portions of the drawing figures are included
to show unclaimed subject matter only and form no part of
the claimed design. In particular, the connector bar between
the exercise handles shown in broken lines forms no part of
the claimed invention.

1 Claim, 5 Drawing Sheets

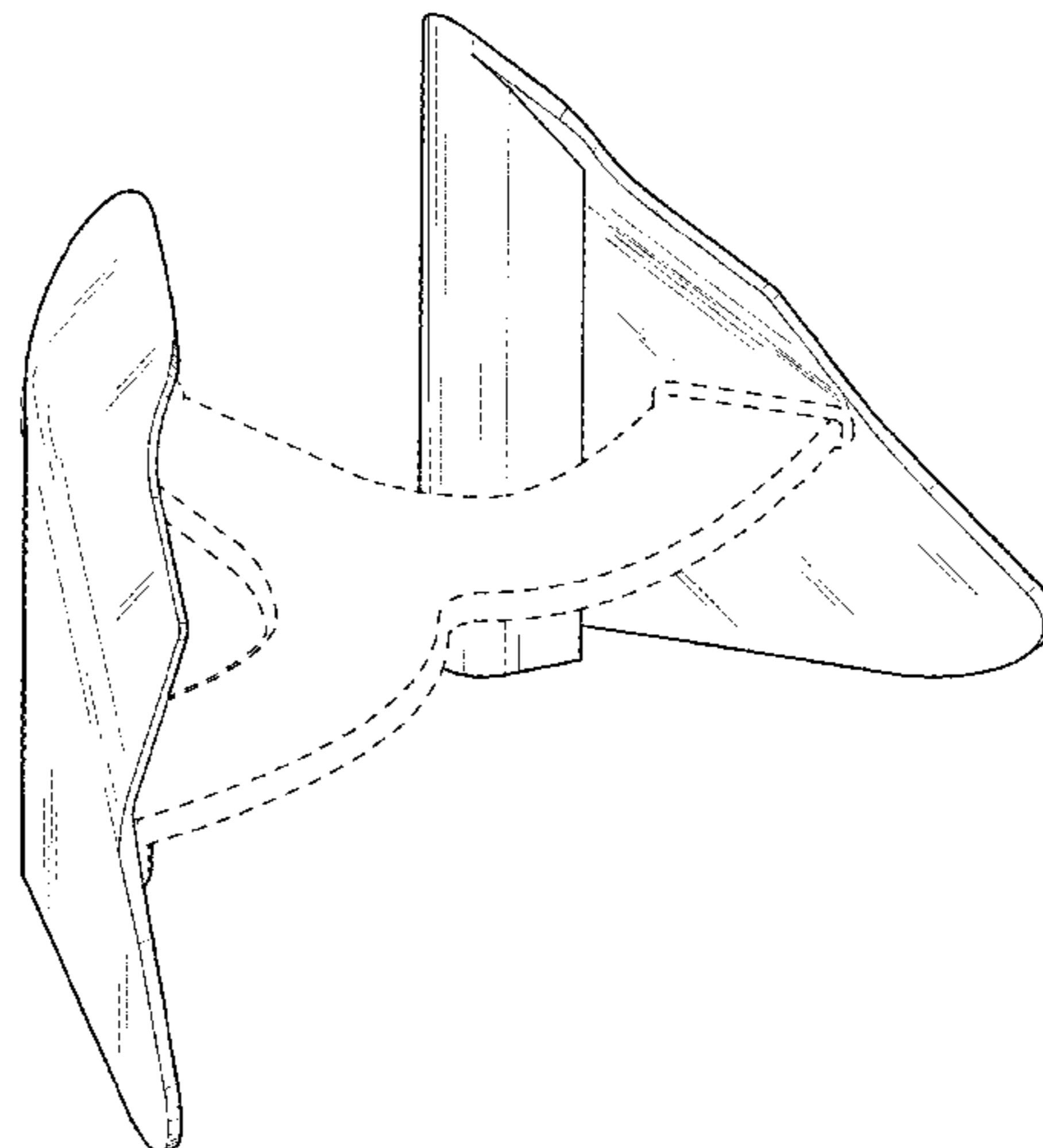

(56)

References Cited

U.S. PATENT DOCUMENTS

D305,256	S	12/1989	Pearson	
D317,032	S	5/1991	Eckler	
5,076,578	A	12/1991	Askonen	
D324,894	S *	3/1992	Porcello	D21/679
5,312,314	A *	5/1994	Stephan	A63B 21/0602 482/106
D394,482	S *	5/1998	Colonello	D21/673
5,761,767	A	6/1998	Barton	
D396,510	S *	7/1998	Marney	D21/684
6,220,988	B1	4/2001	Williams	
7,093,698	B1 *	8/2006	Chen	B62K 21/14 188/379
D549,414	S	8/2007	Van Landingham, Jr.	
D565,133	S *	3/2008	Mollet	D21/694
7,350,437	B2 *	4/2008	Mangano	B62K 21/12 74/551.1
D577,276	S	9/2008	Matijevic	
7,993,245	B1	8/2011	Dorfinan	
D662,161	S *	6/2012	Miller	D21/662
D704,779	S *	5/2014	Boatwright	D21/686
D716,625	S	11/2014	Pereyra	
D725,455	S *	3/2015	Carlini	D8/303
D728,039	S	4/2015	Groshek et al.	
9,254,410	B1 *	2/2016	Mirza	A63B 21/0004
D777,625	S *	1/2017	Chang	D12/178
D786,518	S	5/2017	Szekely	
D812,158	S *	3/2018	Campanaro	D21/690
D812,159	S *	3/2018	Campanaro	D21/690
D815,575	S *	4/2018	Temmerman	D12/178
D818,058	S *	5/2018	Barton	D21/679
D818,059	S *	5/2018	Barton	D21/679
D818,060	S *	5/2018	Barton	D21/679
D818,061	S *	5/2018	Barton	D21/679
D818,063	S *	5/2018	Barton	D21/694
D843,506	S *	3/2019	Campanaro	D21/679
2005/0143230	A1 *	6/2005	Dalebout	A63B 23/03525 482/121
2006/0211552	A1	9/2006	Williams	
2010/0018341	A1 *	1/2010	Greppi	B62K 21/12 74/551.1
2010/0186543	A1 *	7/2010	Menghini	B62K 21/145 74/551.1
2013/0303348	A1	11/2013	Cardin	
2014/0287886	A1	9/2014	Patti	
2018/0001127	A1 *	1/2018	Caouette	A63B 21/0724

OTHER PUBLICATIONS

Michael Gundill by Michael Gundill dated Jun. 5, 2012. Found online [Apr. 29, 2020] <https://www.youtube.com/watch?v=r9GbFd2xuFQ>.*

MAG Grip Products Webpage, MAG Maximum Advantage Grip Website, Web page <<http://maxagrip.com/products.html>>, 2 pages, dated Oct. 17, 2013, retrieved from Internet Archive Wayback Machine <<https://web.archive.org/web/20131017005713/http://maxagrip.com/products.html>> on Sep. 14, 2016.

Close Grip Neutral on MAG Grip Products Webpage, MAG Maximum Advantage Grip Website, Web page <<http://maxagrip.com/products.html>>, 2 pages, dated Oct. 17, 2013, retrieved from Internet Archive Wayback Machine <<https://web.archive.org/web/20131017005713/http://maxagrip.com/products.html>> on Sep. 14, 2016.

Close Grip Pronate on MAG Grip Products Webpage, MAG Maximum Advantage Grip Website, Web page <<http://maxagrip.com/products.html>>, 2 pages, dated Oct. 17, 2013, retrieved from Internet Archive Wayback Machine <<https://web.archive.org/web/20131017005713/http://maxagrip.com/products.html>> on Sep. 14, 2016.

Close Grip Supinate on MAG Grip Products Webpage, MAG Maximum Advantage Grip Website, Web page <<http://maxagrip.com/products.html>>, 2 pages, dated Oct. 17, 2013, retrieved from Internet Archive Wayback Machine <<https://web.archive.org/web/20131017005713/http://maxagrip.com/products.html>> on Sep. 14, 2016.

Medium Grip Neutral on MAG Grip Products Webpage, MAG Maximum Advantage Grip Website, Web page <<http://maxagrip.com/products.html>>, 2 pages, dated Oct. 17, 2013, retrieved from Internet Archive Wayback Machine <<https://web.archive.org/web/20131017005713/http://maxagrip.com/products.html>> on Sep. 14, 2016.

Medium Grip Pronate on MAG Grip Products Webpage, MAG Maximum Advantage Grip Website, Web page <<http://maxagrip.com/products.html>>, 2 pages, dated Oct. 17, 2013, retrieved from Internet Archive Wayback Machine <<https://web.archive.org/web/20131017005713/http://maxagrip.com/products.html>> on Sep. 14, 2016.

Medium Grip Supinate on MAG Grip Products Webpage, MAG Maximum Advantage Grip Website, Web page <<http://maxagrip.com/products.html>>, 2 pages, dated Oct. 17, 2013, retrieved from Internet Archive Wayback Machine <<https://web.archive.org/web/20131017005713/http://maxagrip.com/products.html>> on Sep. 14, 2016.

Michael Gundill by Michael Gundill dated Jun. 4, 2012. Found online [Jan. 2, 2017] <https://www.youtube.com/watch?v=r9GbFd2xuFQ>.

Products MAG Lat Bar by MAG dated no date given. Found online [Jan. 2, 2017] <http://maxagrip.com/products.html>.

First office action on the merits (Non-Final Rejection) in U.S. Appl. No. 29/571,569, dated Jan. 3, 2018.

Second office action on the merits (Final Rejection) in U.S. Appl. No. 29/571,569, dated May 14, 2018.

* cited by examiner

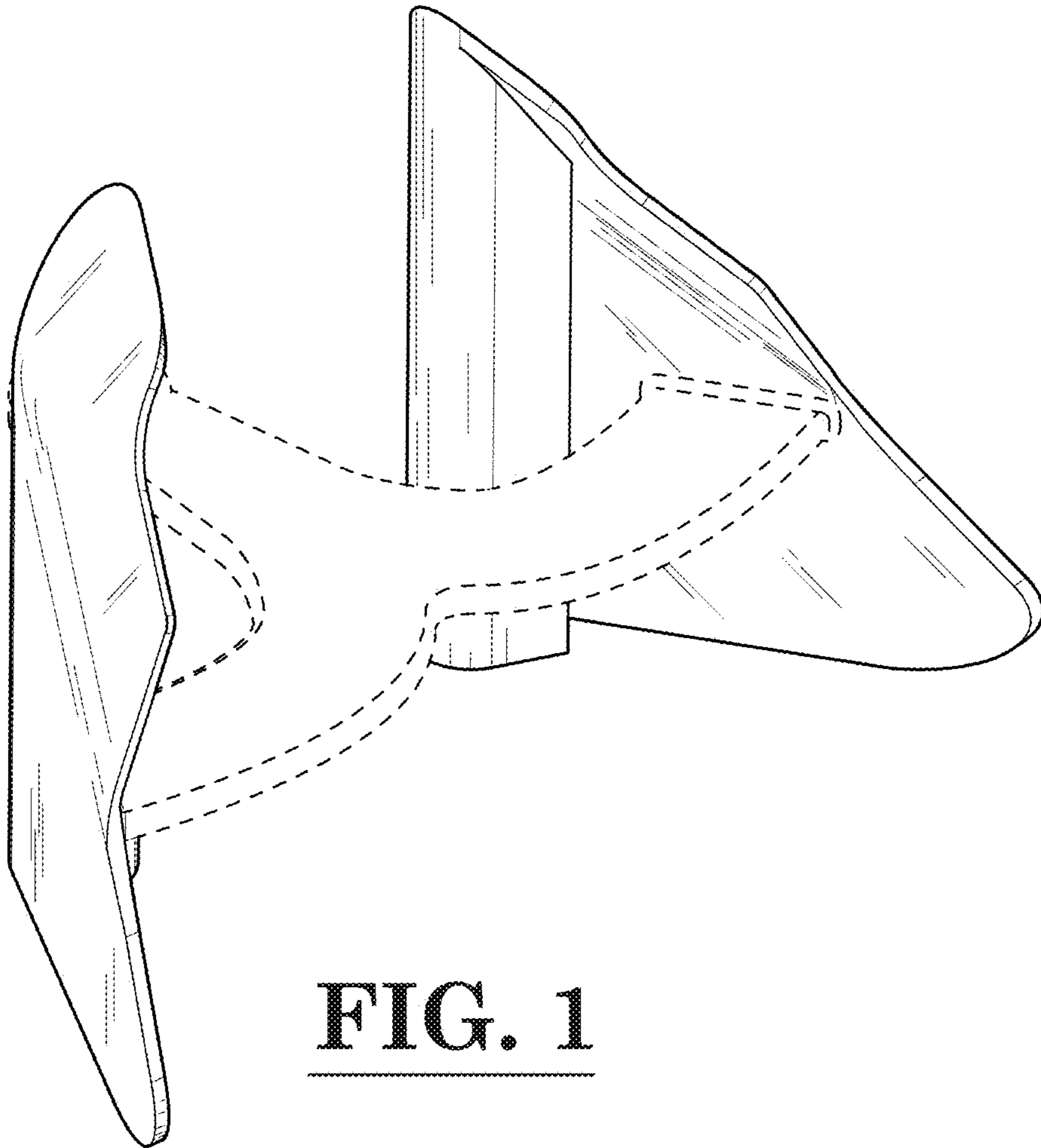

FIG. 1

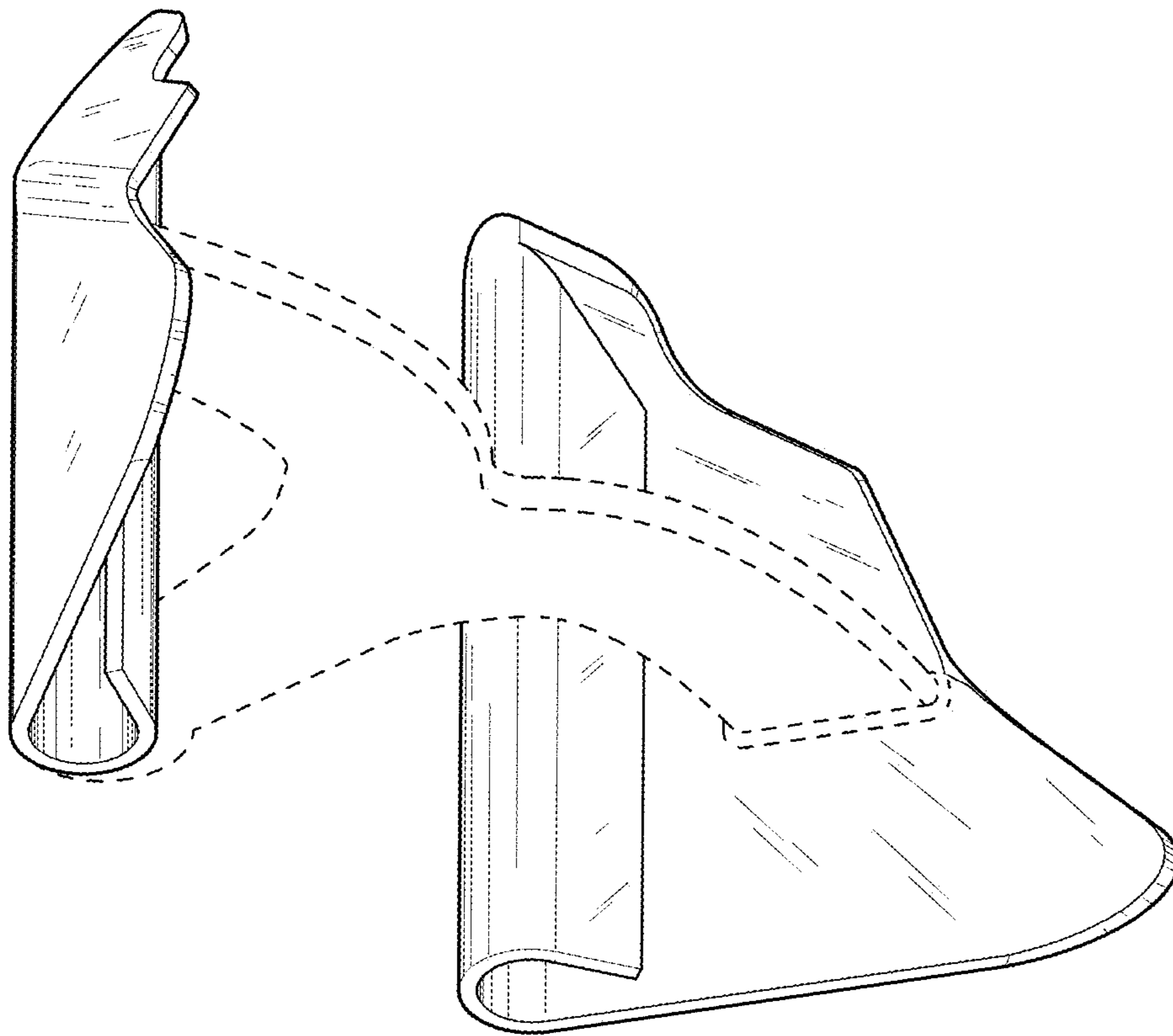
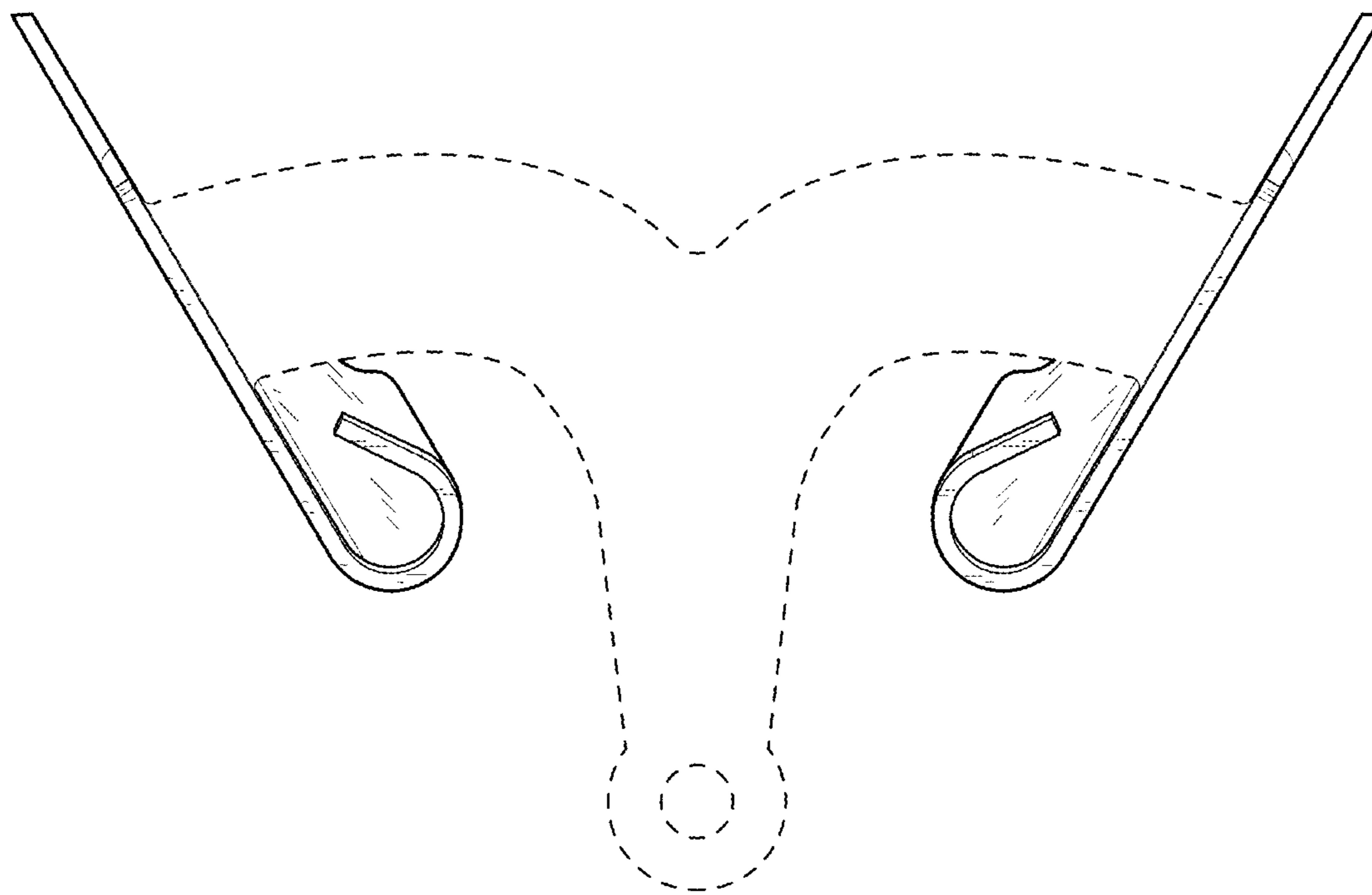
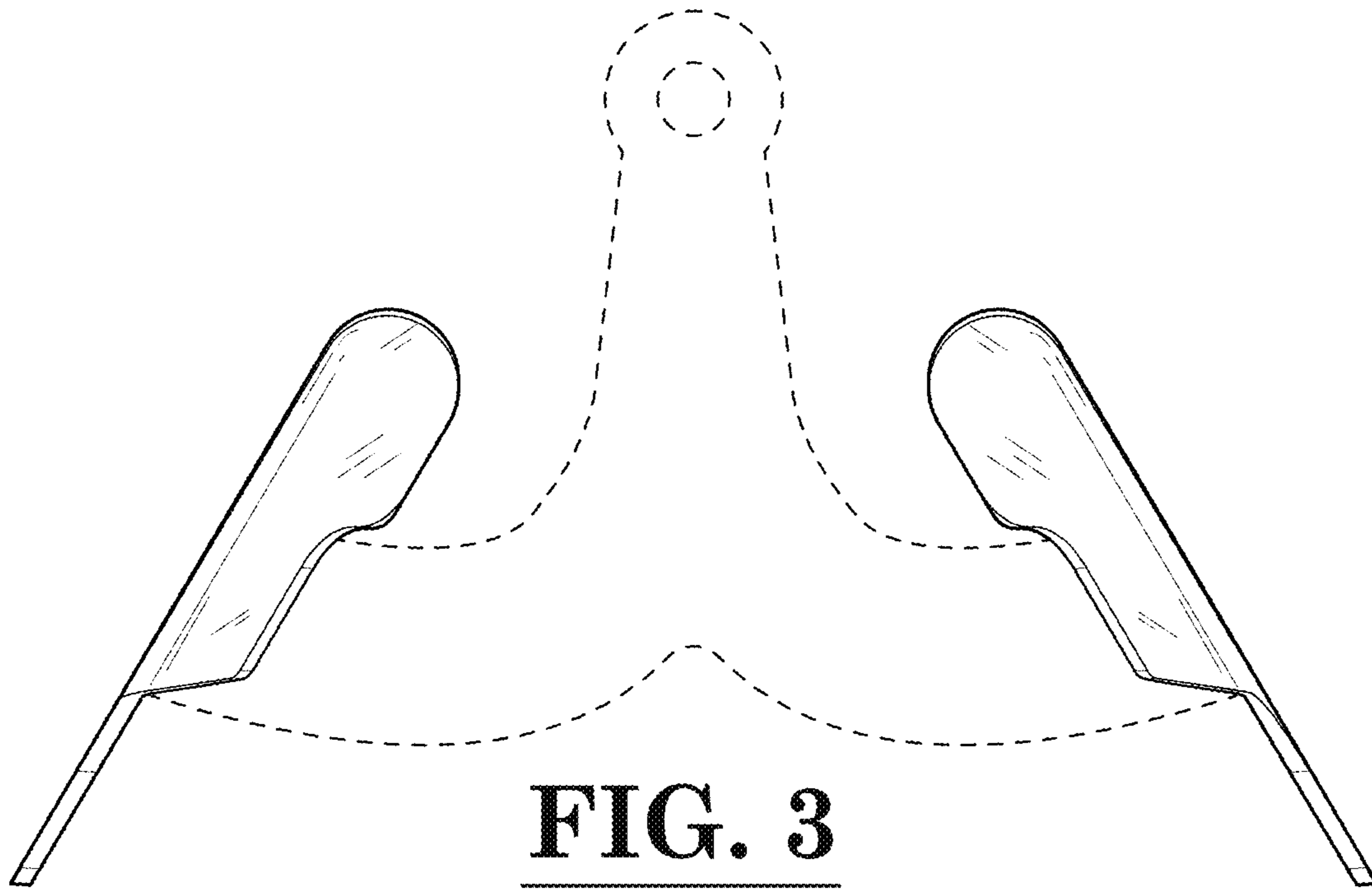

FIG. 2



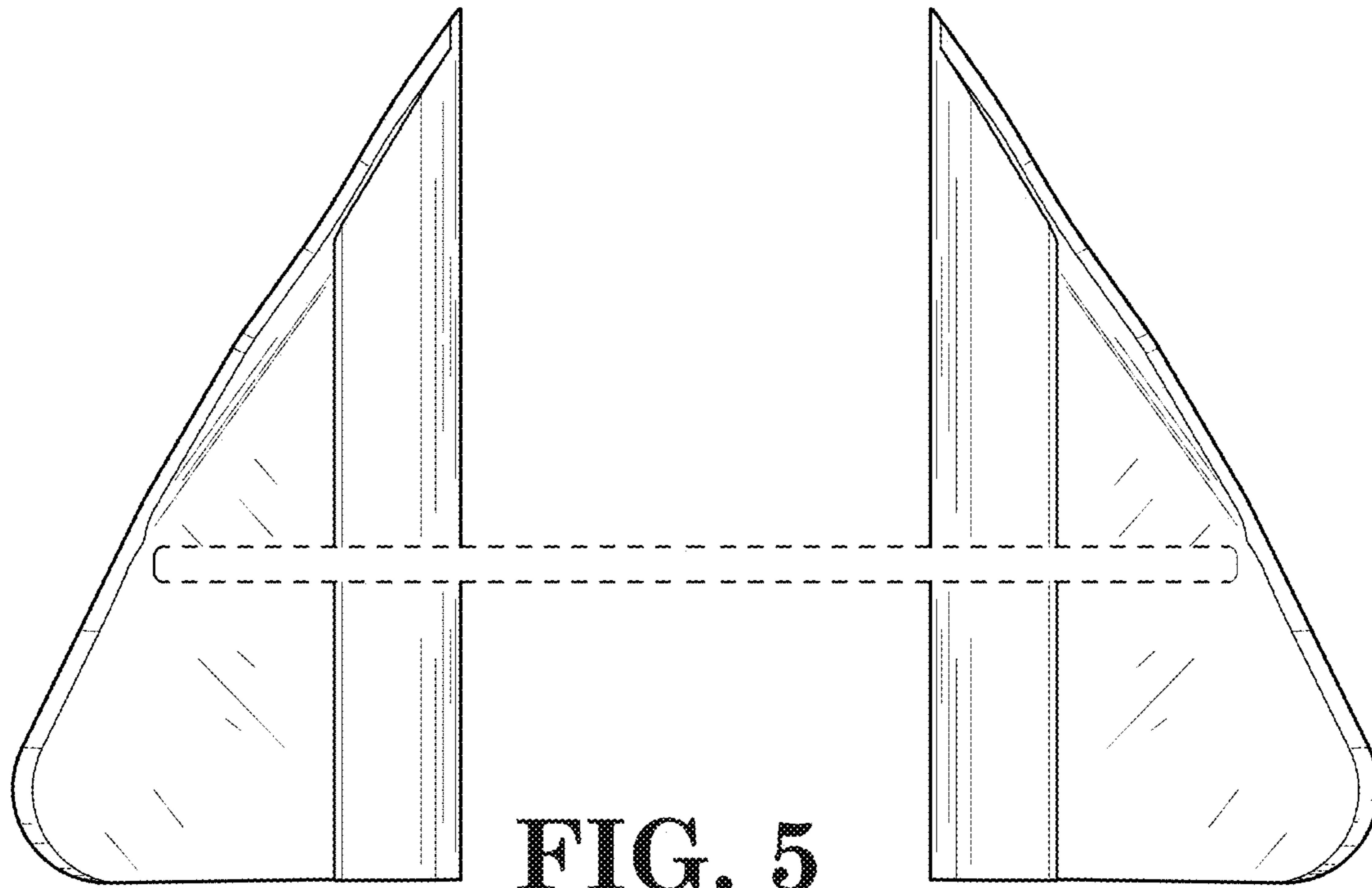

FIG. 5

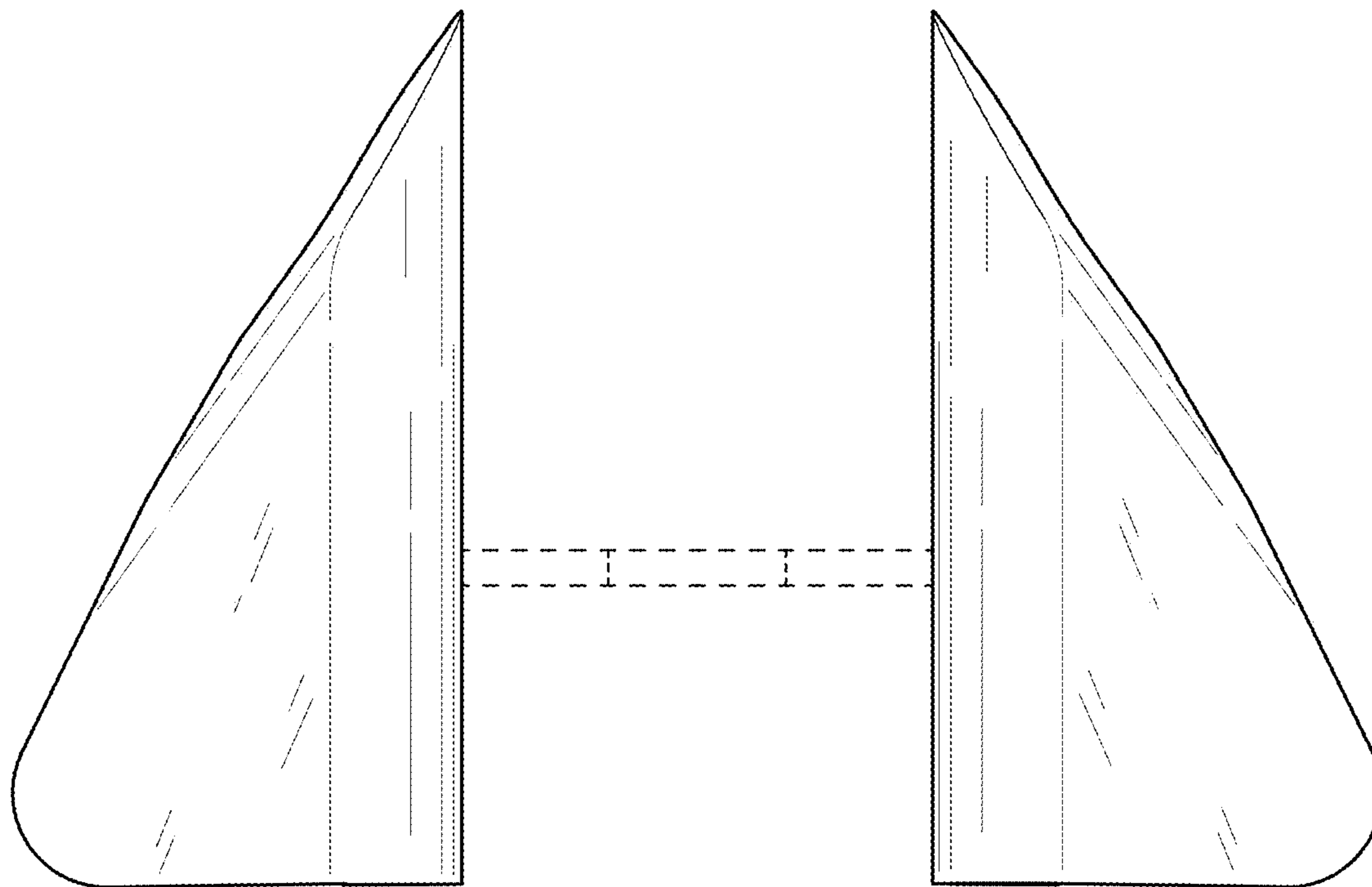

FIG. 6

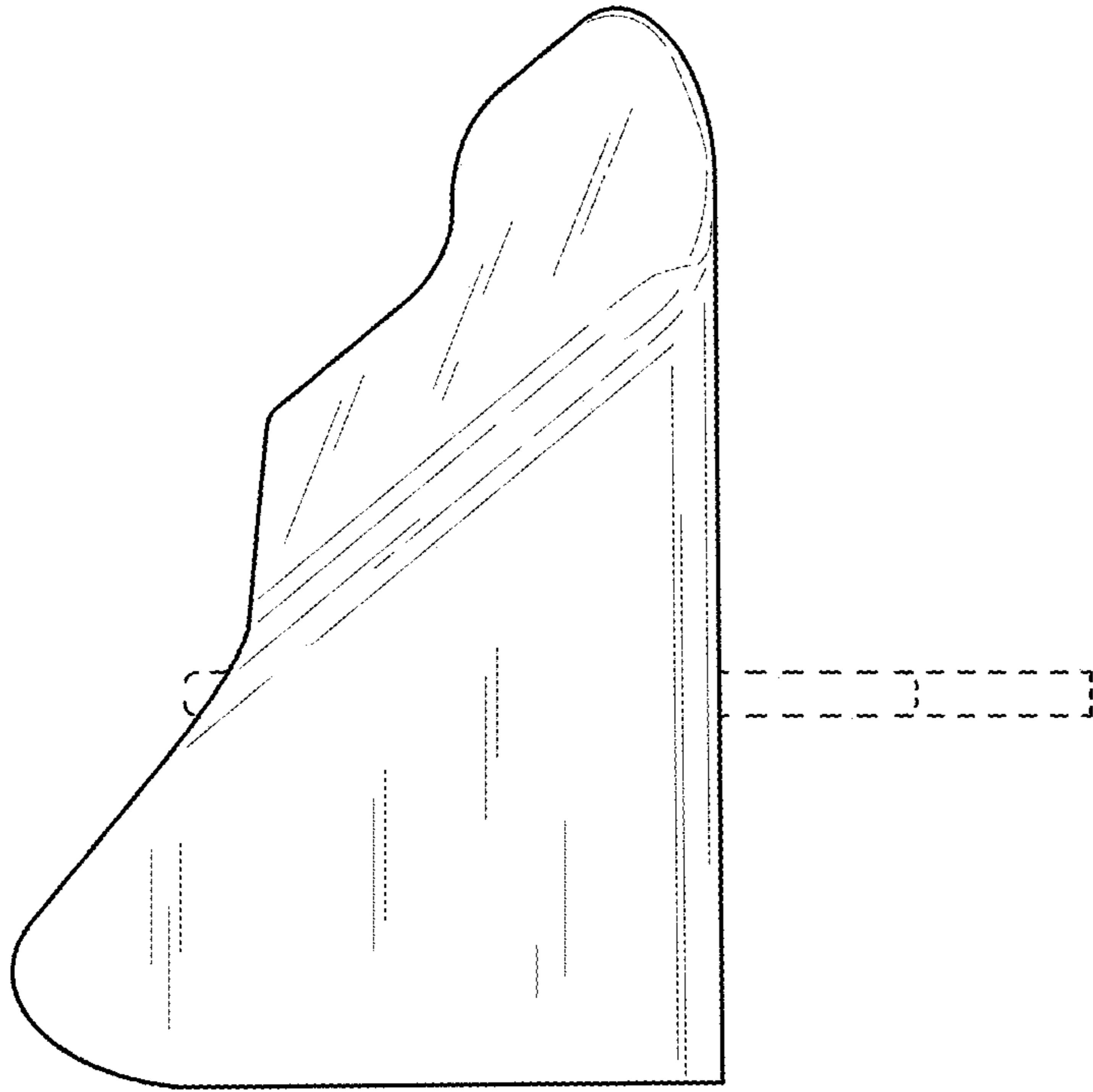

FIG. 7

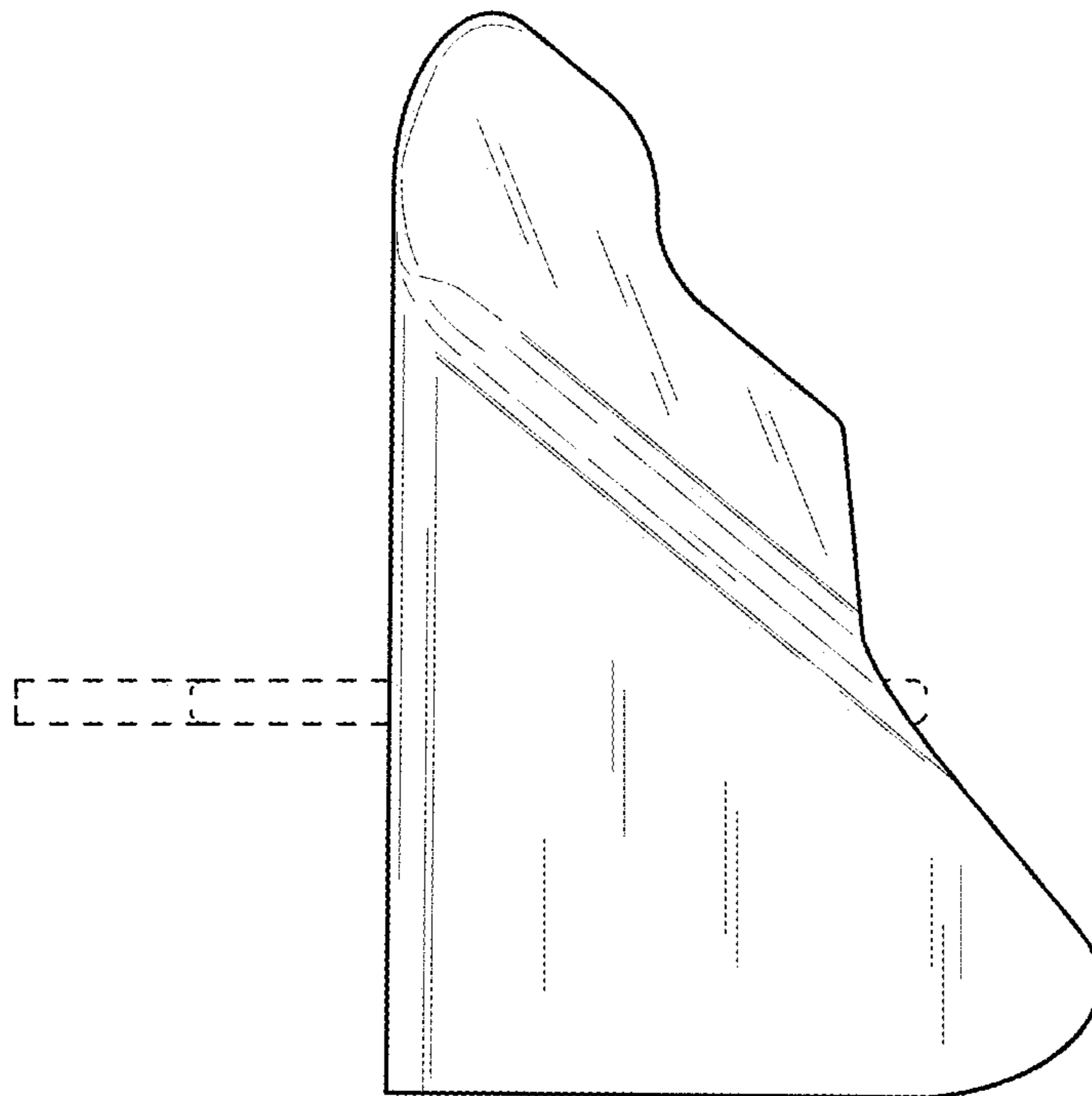

FIG. 8