



US00D907712S

(12) **United States Design Patent** (10) **Patent No.:** **US D907,712 S**
DeMarco et al. (45) **Date of Patent:** **** *Jan. 12, 2021**

(54) **GAMING MACHINE**

CPC G07F 17/32; G07F 17/34; G07F 17/3211;
G07F 17/3244; G07F 17/3267
See application file for complete search history.

(71) Applicant: **ARISTOCRAT TECHNOLOGIES AUSTRALIA PTY LIMITED**, North Ryde (AU)

(56)

References Cited

U.S. PATENT DOCUMENTS

(72) Inventors: **Dominic J. DeMarco**, Round Rock, TX (US); **Bruce Edward Urban**, Las Vegas, NV (US); **James Franklin Stair**, Las Vegas, NV (US); **Ariel David Turgel**, San Francisco, CA (US); **Daniel Harden**, Palo Alto, CA (US); **Alexander Abele**, Aalen (DE)

D415,124	S	*	10/1999	Rooyakkers	D14/306
D428,864	S	*	8/2000	Rooyakkers	D14/306
D464,377	S		10/2002	Wurz		
D479,243	S		9/2003	Ohashi		
D508,719	S	*	8/2005	de Haas	D21/325
D513,044	S	*	12/2005	Morrison	D21/370
6,997,810	B2		2/2006	Cole		
D531,677	S		11/2006	Mallory		
D546,893	S	*	7/2007	Yamashita	D21/325
D560,724	S		1/2008	Johnson		
D560,725	S		1/2008	Johnson		
D562,338	S		2/2008	Keohane		
D572,314	S		7/2008	Vallejo		
D579,456	S		10/2008	Chen		
D587,319	S		2/2009	Moises Deiab		
D599,858	S		9/2009	Lesley		
D599,859	S		9/2009	Lesley		
D604,773	S	*	11/2009	De Viveiros Ortiz	D21/325
D612,432	S	*	3/2010	De Viveiros Ortiz	D21/325
D613,802	S		4/2010	Meyers		
D619,177	S	*	7/2010	Lee	D21/325
D622,781	S		8/2010	Lesley		
D626,182	S		10/2010	Cole		
D628,208	S		11/2010	Potemski		
D646,337	S		10/2011	Kelly		
D652,454	S		1/2012	Yopez		
D666,625	S		9/2012	Gilmore		
D668,261	S		10/2012	Arnold		
D673,620	S		1/2013	Johnson		
D673,621	S		1/2013	Johnson		
D677,736	S		3/2013	Dorn		
D678,956	S		3/2013	Lesley		
D679,722	S		4/2013	Ray		
D685,033	S		6/2013	Wudtke		
D689,899	S		9/2013	Lee		
D691,665	S		10/2013	Chudek		
D693,841	S		11/2013	Velasco		
D695,733	S	*	12/2013	Damhuis	D14/307
D697,558	S		1/2014	Myers		
D704,273	S		5/2014	Chudek		
D706,741	S		6/2014	Myers		
D707,646	S		6/2014	Kim		
D713,841	S		9/2014	Lim		
8,832,598	B2		9/2014	Hirata		
D719,616	S		12/2014	Inoue		

(73) Assignee: **Aristocrat Technologies Australia Pty Ltd.**, North Ryde (AU)

(*) Notice: This patent is subject to a terminal disclaimer.

(**) Term: **15 Years**

(21) Appl. No.: **29/684,838**

(22) Filed: **Mar. 25, 2019**

(51) **LOC (13) Cl.** **21-03**

(52) **U.S. Cl.**
USPC **D21/369**

(58) **Field of Classification Search**
USPC D21/369, 370, 371, 385, 329, 325, 394;
D14/307, 172, 129, 325, 401, 371, 126,
D14/439, 432, 450, 128, 375, 248, 374,
D14/341, 138 G, 127; 463/28, 13, 11,
463/16, 20, 25, 31, 46, 23, 30, 17, 36, 29,
463/42, 34, 32, 35, 19, 21, 22; 273/292,
273/203, 138.2, 143 R, 142 R, 138.1;
D19/60; D16/226; D8/335, 331, 334;
D26/141; D7/641

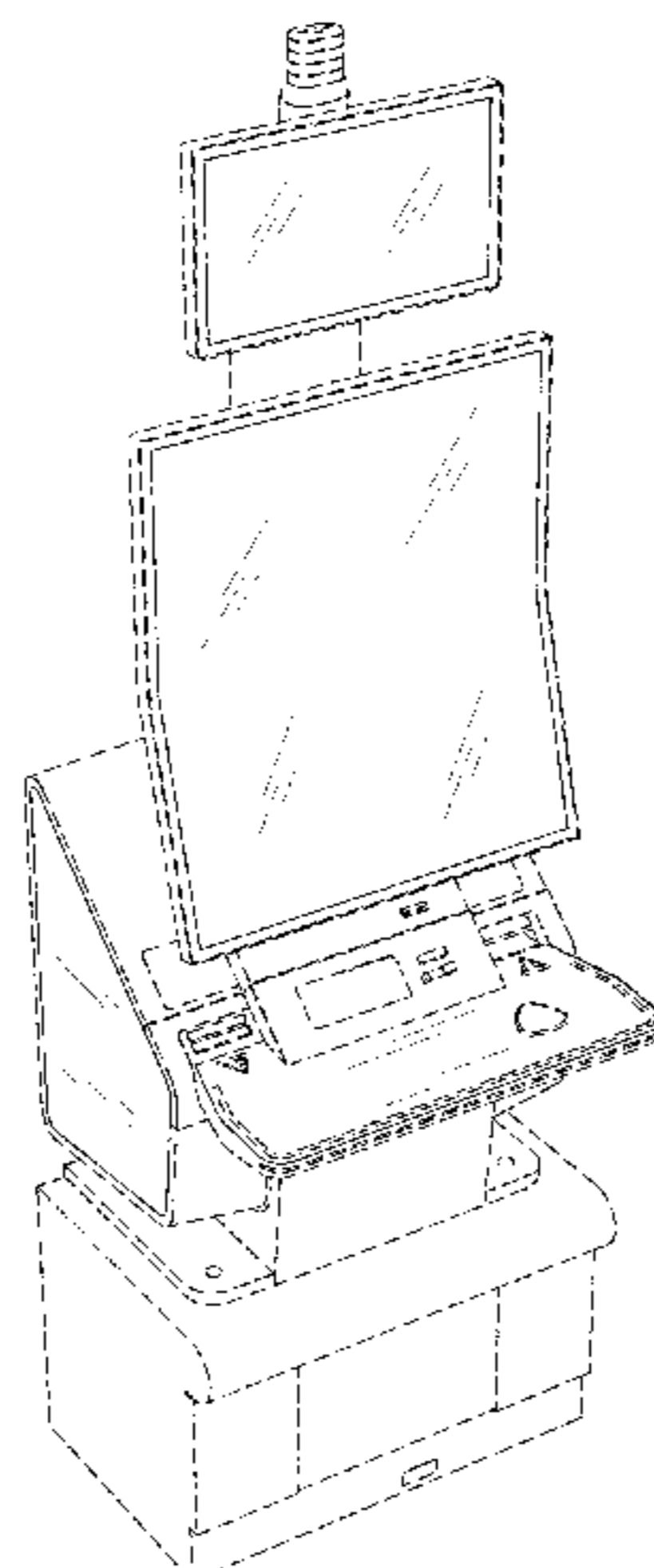

US D907,712 S

D723,626 S	3/2015	Vasquez		D872,190 S *	1/2020	Zedell, Jr.	D21/369
D727,431 S	4/2015	Themann		10,580,252 B2	3/2020	Whelan	
D728,585 S	5/2015	Lee		D880,605 S	4/2020	Bussey	
D730,993 S	6/2015	Castro		D880,606 S	4/2020	Glenn, II	
D732,520 S	6/2015	Themann		D880,608 S	4/2020	Glenn, II	
D734,733 S	7/2015	Park		D880,610 S	4/2020	Glenn, II	
D736,171 S	8/2015	Lee		D880,611 S	4/2020	Glenn, II	
D740,887 S	10/2015	Randazzo		D880,612 S	4/2020	Bernard	
D740,888 S	10/2015	DePalma		D880,613 S	4/2020	Bernard	
D742,974 S	11/2015	Lesley		D880,614 S	4/2020	Bernard	
D749,342 S	2/2016	Escandon		D880,615 S	4/2020	Bernard	
D759,096 S	6/2016	Seo		D881,284 S	4/2020	Glenn	
D760,275 S	6/2016	Zhang		D881,285 S	4/2020	Glenn	
D765,136 S	8/2016	Lee		D882,697 S	4/2020	Lesley	
RE46,169 E	10/2016	Kelly		D875,091 S	8/2020	Kwon	
D772,240 S	11/2016	Edstrom		2013/0084948 A1	4/2013	Watkins	
D772,273 S	11/2016	Spector		2014/0335934 A1	11/2014	Meyer	
D773,512 S	12/2016	Miura		2015/0018070 A1	1/2015	Meyer	
D780,852 S *	3/2017	Sharp	D21/329	2015/0036073 A1	2/2015	Im	
D785,664 S	5/2017	Yao		2016/0093143 A1	3/2016	Lamb	
D790,563 S	6/2017	Laman, IV		2016/0195938 A1	7/2016	Kim	
9,679,435 B2 *	6/2017	Schrementi	G07F 17/3213	2017/0039802 A1	2/2017	Prabhu	
9,704,337 B2	7/2017	Riggs		2017/0046906 A1	2/2017	Hilbert	
D794,661 S	8/2017	Nishizawa		2017/0092052 A1	3/2017	McKay	
D794,664 S	8/2017	Okabe		2017/0301177 A1	10/2017	Pawloski	
D801,435 S *	10/2017	Themann	D21/369	2018/0075689 A1	3/2018	Castro	
D803,323 S *	11/2017	Bussey	D21/369	2018/0078847 A1	3/2018	Sorreta	
D803,324 S	11/2017	Bussey		2018/0078854 A1	3/2018	Achmueller	
D809,068 S *	1/2018	Ballman	D21/369	2018/0082523 A1	3/2018	Palermo	
D809,069 S *	1/2018	Ballman	D21/369	2019/0012874 A1	1/2019	Goldstein	
D812,146 S	3/2018	Castro		2019/0046872 A1	2/2019	Glenn, II	
D812,147 S	3/2018	Castro		2019/0096161 A1	3/2019	Barbour	
D812,148 S	3/2018	Castro		2019/0096170 A1 *	3/2019	Lewis	G07F 17/3216
D812,149 S	3/2018	Castro		2019/0096173 A1 *	3/2019	Brandau	G07F 17/3216
D814,455 S	4/2018	Kwon		2019/0102971 A1 *	4/2019	Schoonmaker	F16M 11/06
D816,079 S	4/2018	Yamazaki		2019/0102974 A1	4/2019	Bussey	
D818,048 S	5/2018	Calhoun		2019/0102984 A1	4/2019	Gallagher	
D819,747 S	6/2018	Castro		2019/0287337 A1 *	9/2019	Shiraishi	G07F 17/34
D820,915 S	6/2018	Lee		2020/0111291 A1 *	4/2020	Pariseau	G07F 17/34
D826,338 S	8/2018	Bussey		2020/0111295 A1 *	4/2020	Glenn	A63F 9/24
D832,356 S	10/2018	Castro		2020/0111296 A1 *	4/2020	Miura	G07F 17/34
D833,534 S *	11/2018	Lee	D21/369	2020/0111297 A1	4/2020	Kazama	
D834,652 S	11/2018	Lee		2020/0111328 A1 *	4/2020	Bland	G07F 17/3213
10,127,761 B2	11/2018	Woels					
10,181,236 B2	1/2019	Goldstein					
D843,458 S	3/2019	Castro					
D843,467 S	3/2019	Johnson					
D843,468 S	3/2019	Johnson					
D843,473 S	3/2019	Zedell, Jr.					
D843,474 S	3/2019	Lesley					
D843,475 S	3/2019	Lesley					
D843,476 S	3/2019	Lesley					
D843,477 S	3/2019	Lesley					
D843,478 S	3/2019	Lesley					
D843,479 S	3/2019	Castro					
D843,480 S	3/2019	Castro					
D843,482 S	3/2019	Holland					
D844,062 S	3/2019	Lesley					
D846,650 S	4/2019	Stair					
D847,905 S	5/2019	Lewis					
D849,149 S	5/2019	Bussey					
D849,150 S	5/2019	Gallagher					
D850,536 S	6/2019	Stair					
D850,537 S	6/2019	Urban					
D854,621 S	7/2019	Calhoun					
D858,641 S	9/2019	Legras					
D858,642 S	9/2019	Legras					
D859,347 S	9/2019	Kwon					
D862,602 S	10/2019	Kariya					
D865,066 S *	10/2019	Ortiz De Viveiros	D21/369				
D865,873 S *	11/2019	Lewis	D21/369				
D866,666 S	11/2019	Ditton					
D866,667 S	11/2019	Stair					
D866,668 S	11/2019	Ditton					
D868,165 S *	11/2019	Ortiz De Viveiros	D21/369				
D870,818 S *	12/2019	Curbbun	D21/369				
D870,820 S	12/2019	Urban					
D871,506 S	12/2019	Castro					
D871,507 S	12/2019	Urban					

OTHER PUBLICATIONS

Office Action dated Jun. 1, 2020 for U.S. Appl. No. 29/684,808 (pp. 1-9).

Office Action dated Jun. 1, 2020 for U.S. Appl. No. 29/684,812 (pp. 1-9).

Office Action dated Jun. 1, 2020 for U.S. Appl. No. 29/684,832 (pp. 1-9).

Office Action dated Jun. 1, 2020 for U.S. Appl. No. 29/684,836 (pp. 1-9).

Office Action dated Jun. 1, 2020 for U.S. Appl. No. 29/684,844 (pp. 1-9).

Office Action dated Jun. 1, 2020 for U.S. Appl. No. 29/684,849 (pp. 1-9).

Office Action dated Jun. 5, 2020 for U.S. Appl. No. 29/684,847 (pp. 1-9).

Office Action dated Jun. 12, 2020 for U.S. Appl. No. 29/684,810 (pp. 1-10).

Office Action dated Jun. 12, 2020 for U.S. Appl. No. 29/684,814 (pp. 1-10).

Office Action dated Jun. 12, 2020 for U.S. Appl. No. 29/684,817 (pp. 1-11).

Office Action dated Jun. 12, 2020 for U.S. Appl. No. 29/684,842 (pp. 1-11).

Office Action dated Jun. 12, 2020 for U.S. Appl. No. 29/684,883 (pp. 1-8).

Office Action dated Jun. 12, 2020 for U.S. Appl. No. 29/684,890 (pp. 1-9).

Office Action dated Jun. 12, 2020 for U.S. Appl. No. 29/684,891 (pp. 1-9).

Office Action dated Jun. 12, 2020 for U.S. Appl. No. 29/684,894 (pp. 1-10).

Office Action dated Jun. 12, 2020 for U.S. Appl. No. 29/684,899 (pp. 1-9).
Office Action dated Jun. 12, 2020 for U.S. Appl. No. 29/684,915 (pp. 1-10).
Office Action dated Jun. 12, 2020 for U.S. Appl. No. 29/684,922 (pp. 1-10).
Office Action dated Jun. 12, 2020 for U.S. Appl. No. 29/684,925 (pp. 1-10).
Office Action dated Jun. 12, 2020 for U.S. Appl. No. 29/684,929 (pp. 1-10).
Office Action dated Jun. 12, 2020 for U.S. Appl. No. 29/684,934 (pp. 1-10).
Office Action dated Jun. 12, 2020 for U.S. Appl. No. 29/684,936 (pp. 1-10).
Office Action dated Jun. 12, 2020 for U.S. Appl. No. 29/684,941 (pp. 1-12).
Office Action dated Jul. 10, 2020 for U.S. Appl. No. 29/684,900 (pp. 1-10).
Office Action dated Jul. 10, 2020 for U.S. Appl. No. 29/684,938 (pp. 1-13).
Notice of Allowance dated Aug. 5, 2020 for U.S. Appl. No. 29/678,496 (pp. 1-7).
Office Action dated Jun. 1, 2020 for U.S. Appl. No. 29/684,806 (pp. 1-9).
Office Action dated Jun. 1, 2020 for U.S. Appl. No. 29/684,807 (pp. 1-8).
Office Action dated Jun. 1, 2020 for U.S. Appl. No. 29/684,809 (pp. 1-7).
Office Action dated Jun. 1, 2020 for U.S. Appl. No. 29/684,811 (pp. 1-7).
Office Action dated Jun. 12, 2020 for U.S. Appl. No. 29/684,912 (pp. 1-10).
Corrected Notice of Allowability dated Aug. 17, 2020 for U.S. Appl. No. 29/678,496 (pp. 1-4).

* cited by examiner

Primary Examiner — Ryan Harvey
(74) *Attorney, Agent, or Firm* — Armstrong Teasdale LLP
(57) **CLAIM**

We claim the ornamental design for a gaming machine, as shown and described.

DESCRIPTION

FIG. 1 is a front perspective view of a gaming machine showing our new design;

FIG. 2 is a front view of the gaming machine shown in FIG. 1;
FIG. 3 is a back view of the gaming machine shown in FIG. 1;
FIG. 4 is a right side view of the gaming machine shown in FIG. 1;
FIG. 5 is a left side view of the gaming machine shown in FIG. 1;
FIG. 6 is a top view of the gaming machine shown in FIG. 1;
FIG. 7 is a bottom view of the gaming machine shown in FIG. 1;
FIG. 8 is a front perspective view of a gaming machine showing an alternative embodiment of our new design;
FIG. 9 is a front view of the gaming machine shown in FIG. 8;
FIG. 10 is a front perspective view of a gaming machine showing a further embodiment of our new design;
FIG. 11 is a front view of the gaming machine shown in FIG. 10;
FIG. 12 is a back view of the gaming machine shown in FIG. 10;
FIG. 13 is a right side view of the gaming machine shown in FIG. 10;
FIG. 14 is a left side view of the gaming machine shown in FIG. 10;
FIG. 15 is a top view of the gaming machine shown in FIG. 10;
FIG. 16 is a bottom view of the gaming machine shown in FIG. 10;
FIG. 17 is a front perspective view of a gaming machine showing another alternative embodiment of our new design; and,
FIG. 18 is a front view of the gaming machine shown in FIG. 17.
The broken line showing of portions of the gaming machine depicts environment and forms no part of the claimed design.

1 Claim, 18 Drawing Sheets

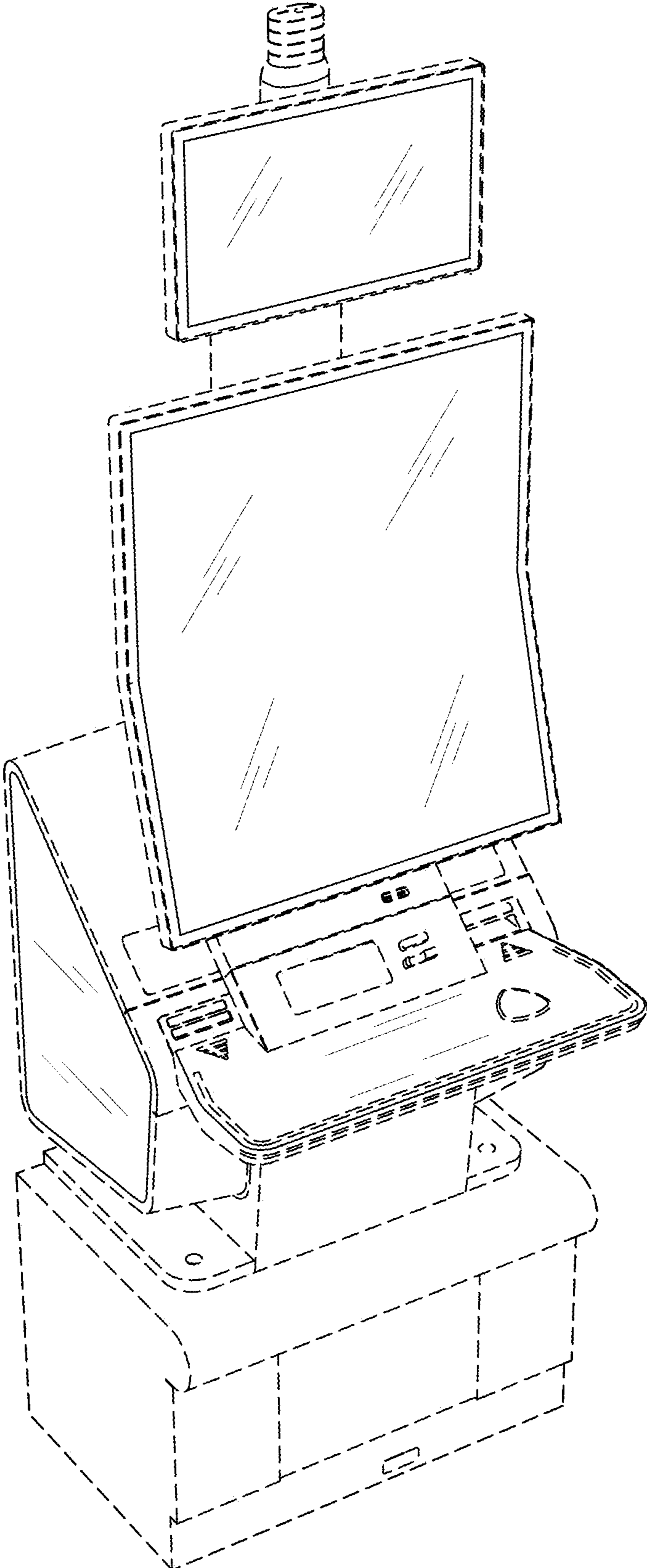

FIG. 1

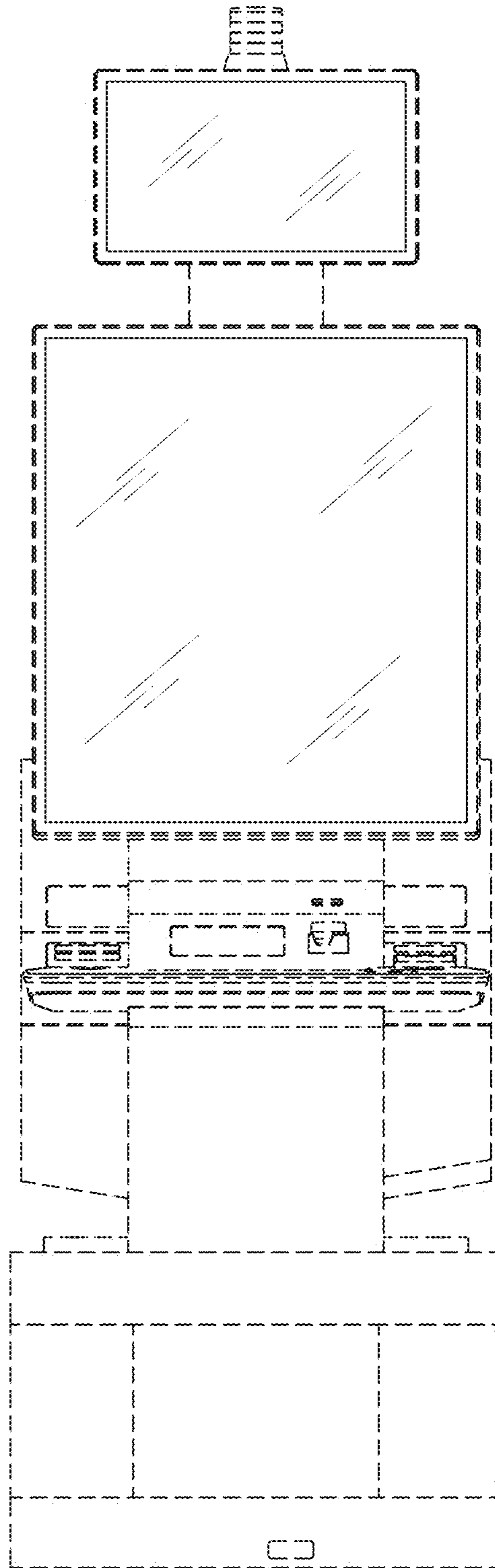

FIG. 2

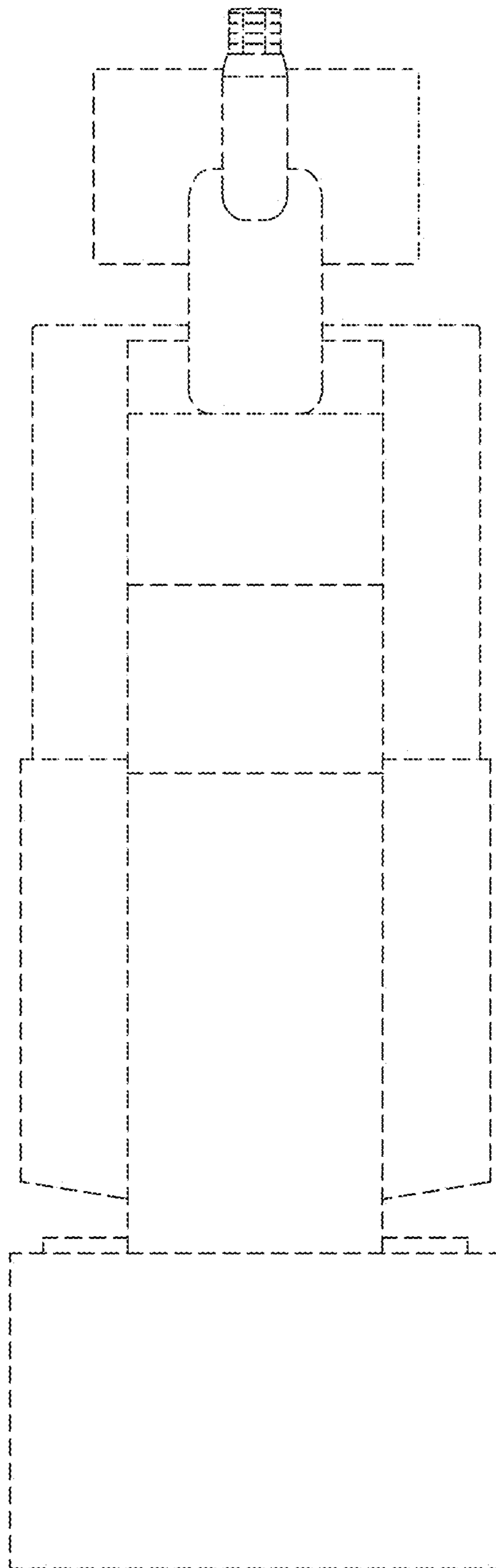

FIG. 3

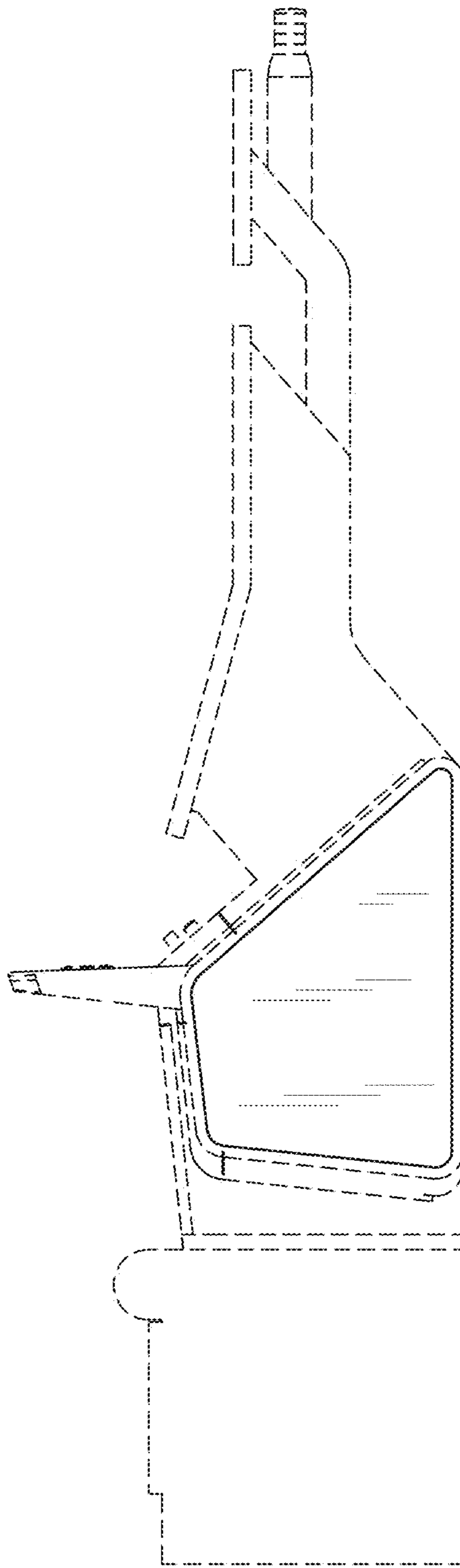

FIG. 4

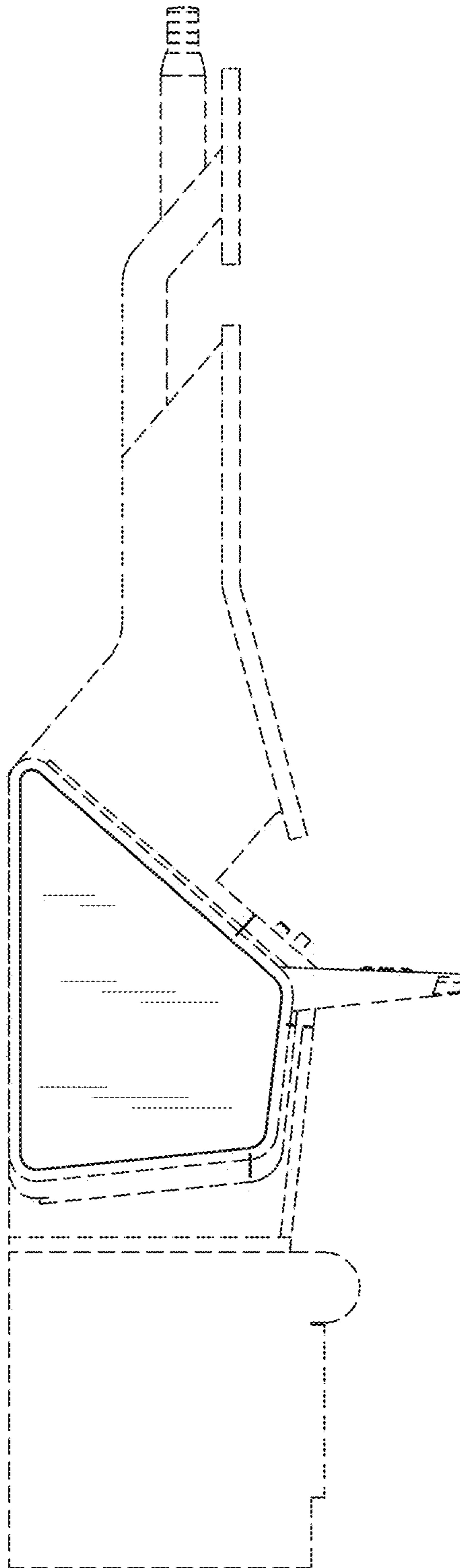

FIG. 5

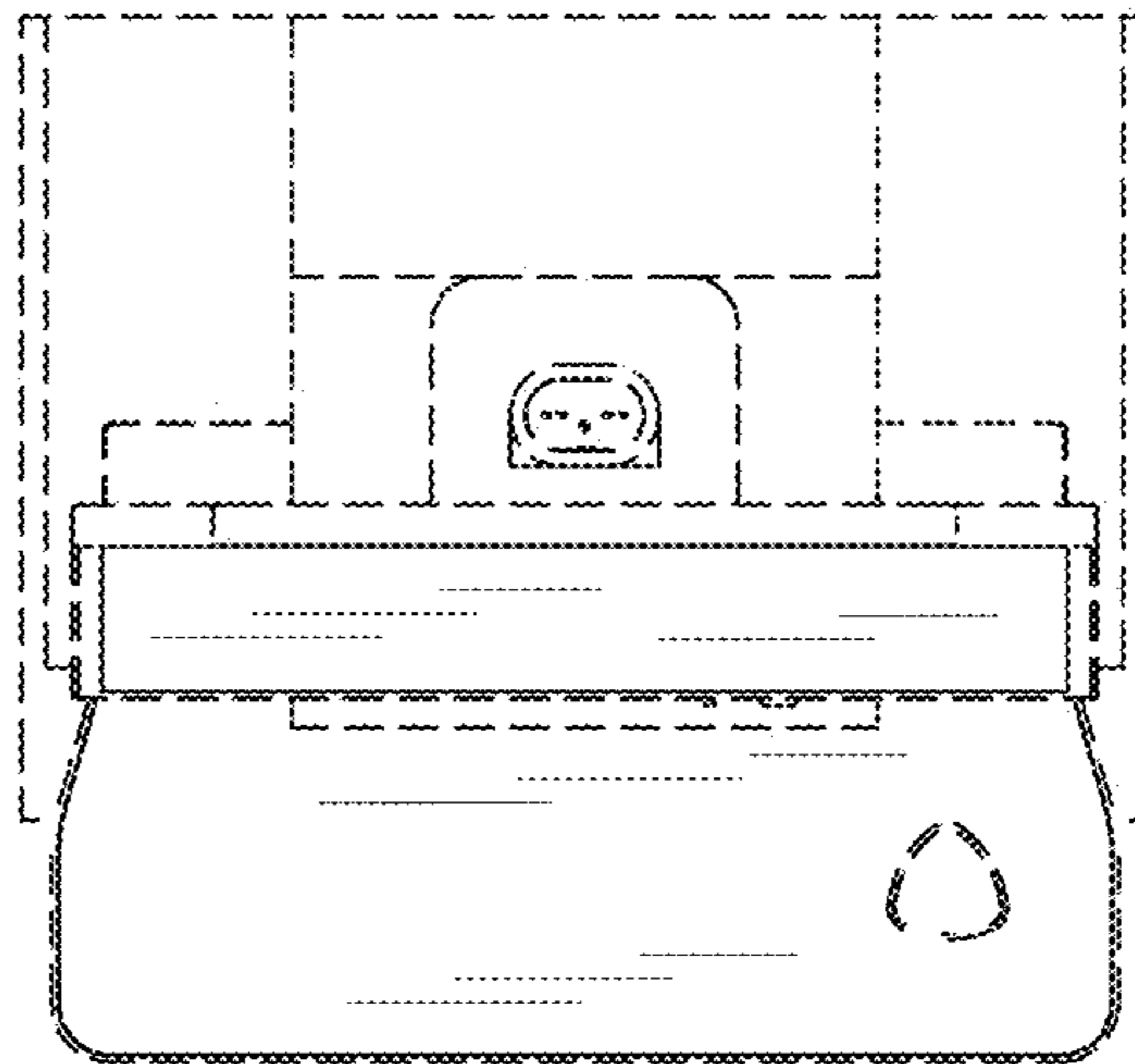

FIG. 6

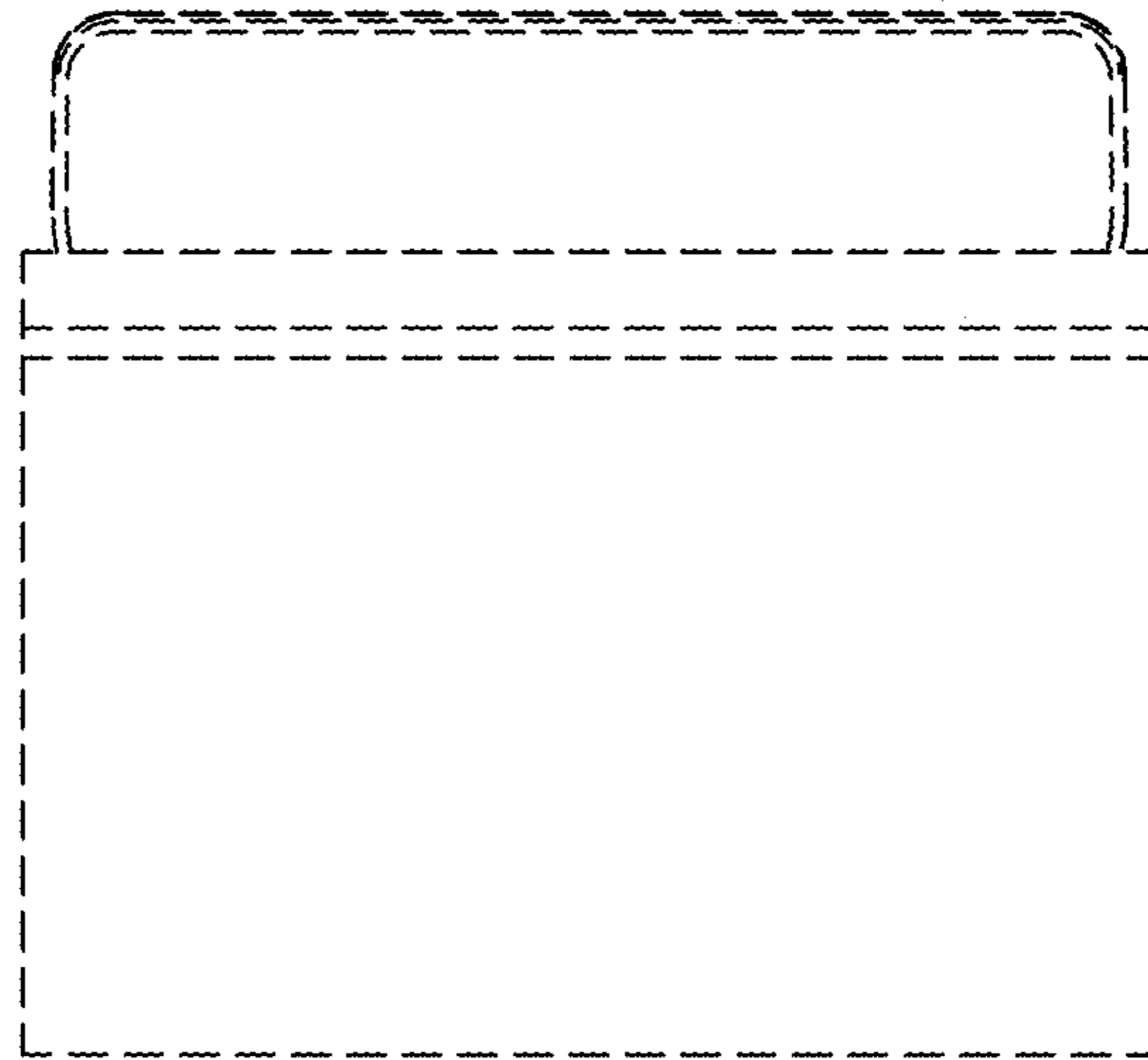

FIG. 7

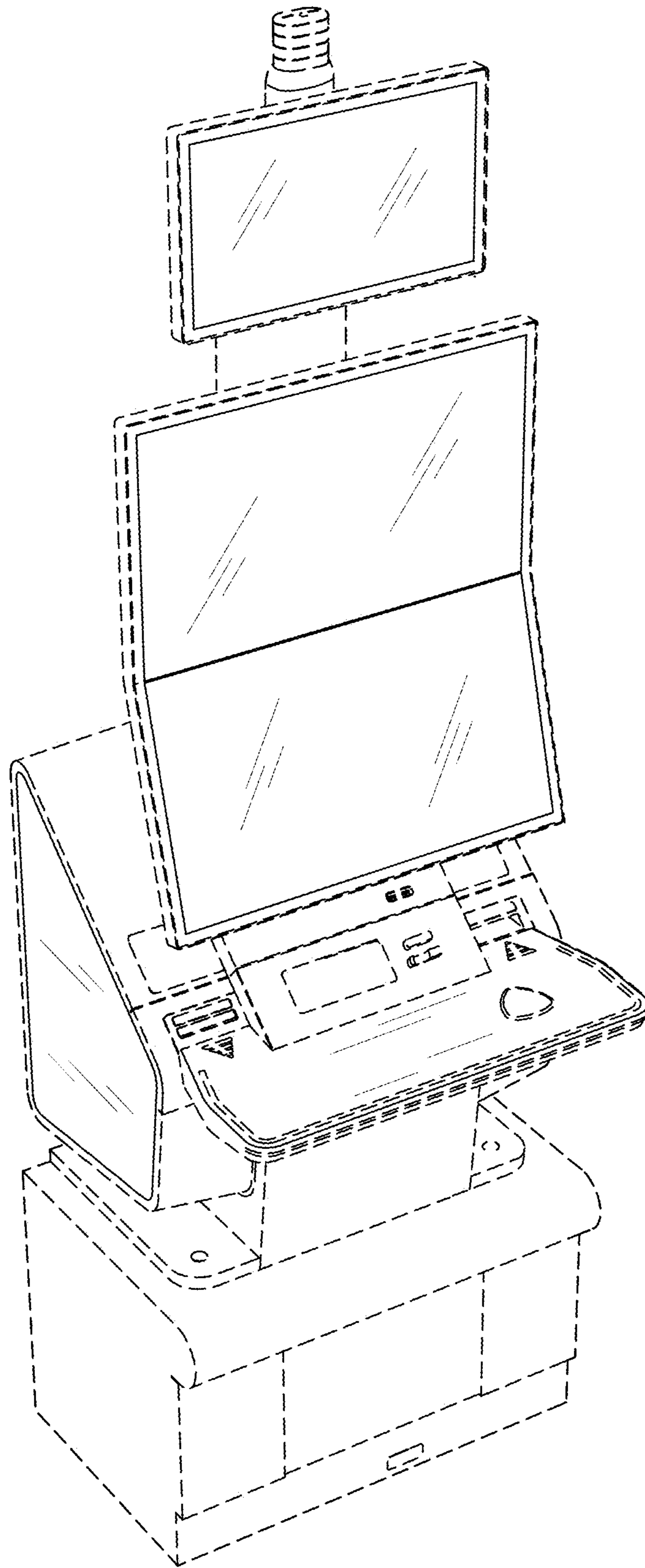

FIG. 8

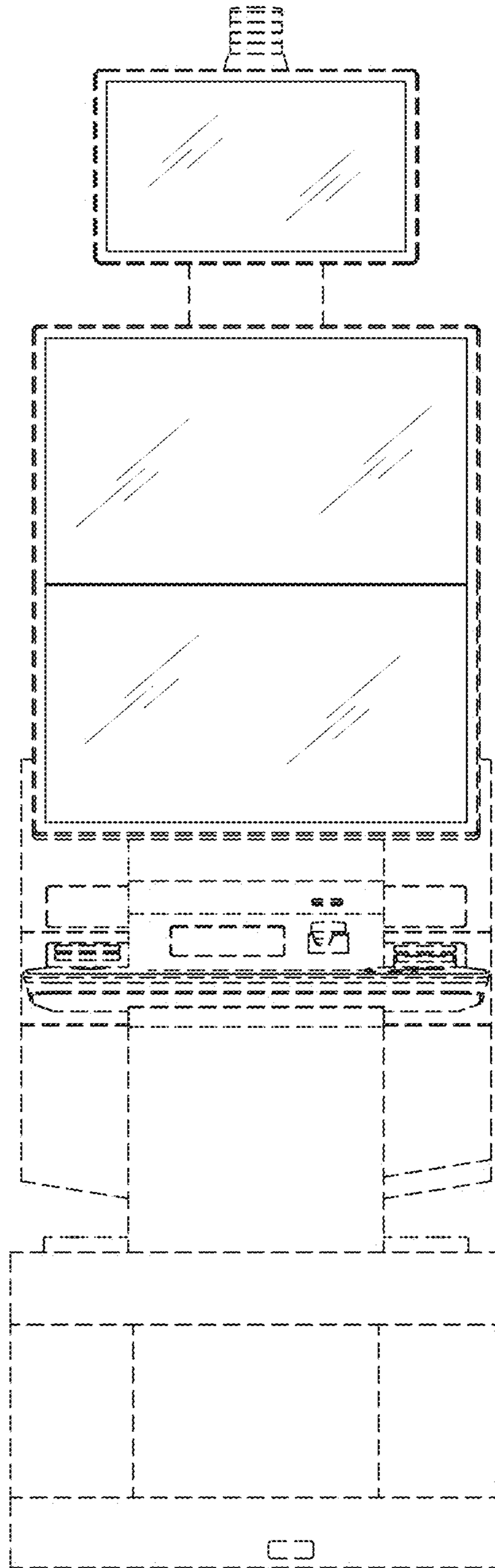

FIG. 9

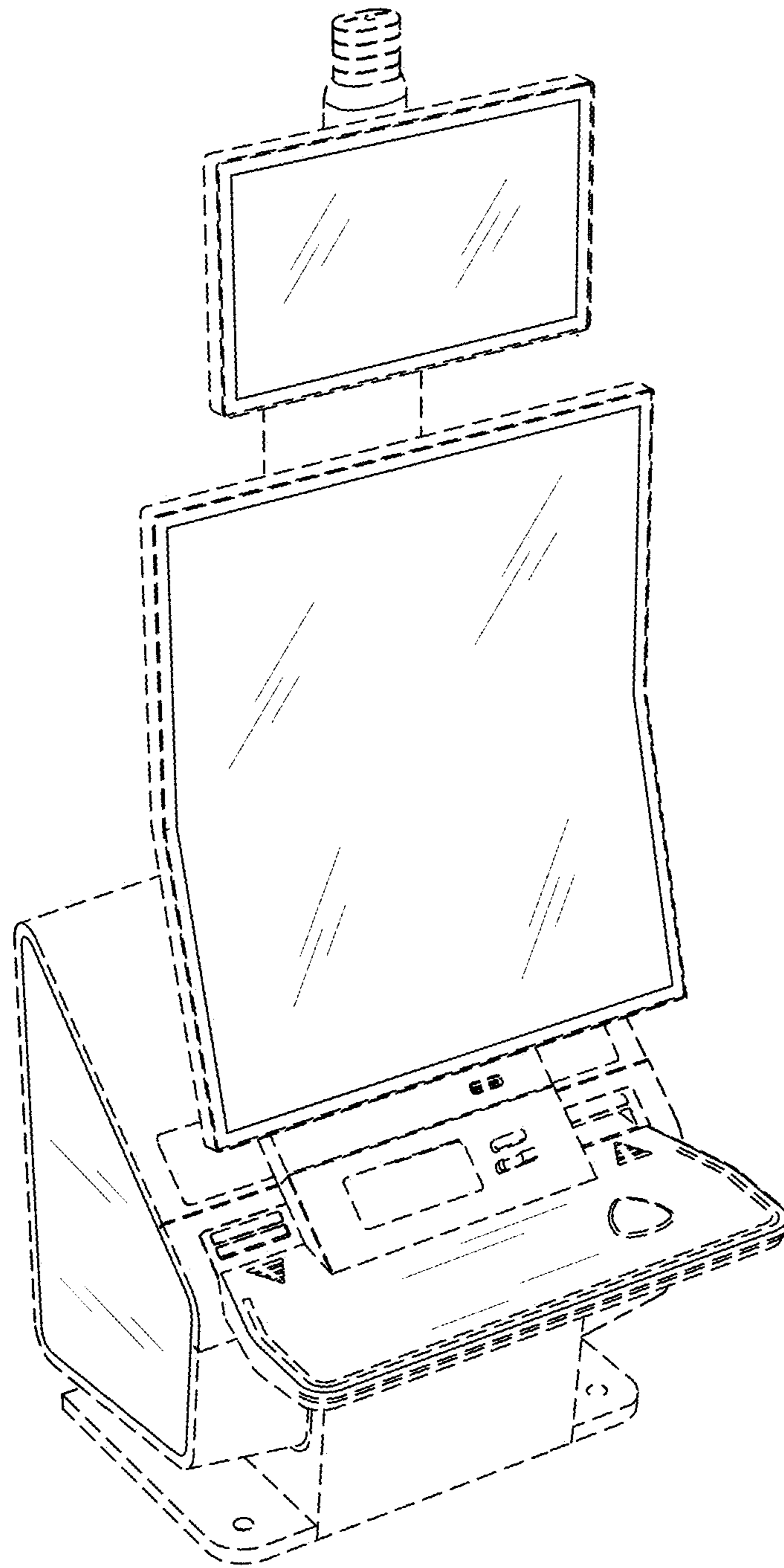

FIG. 10

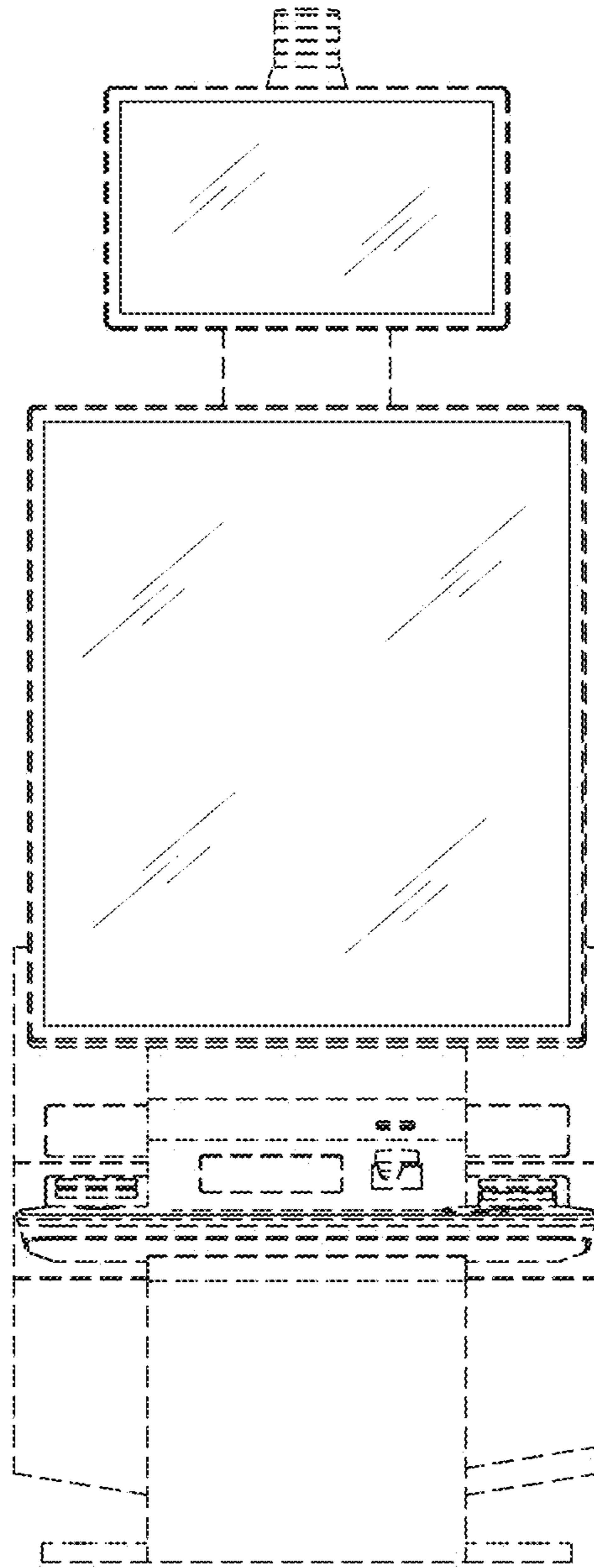

FIG. 11

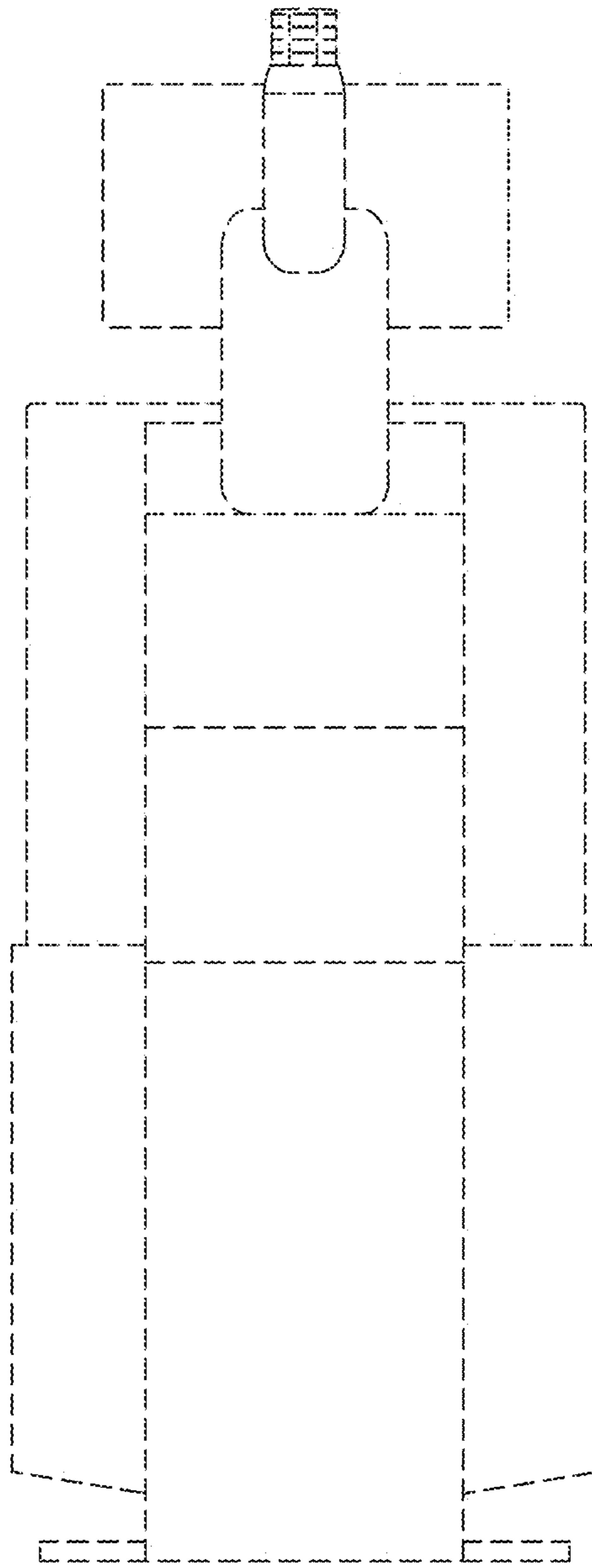

FIG. 12

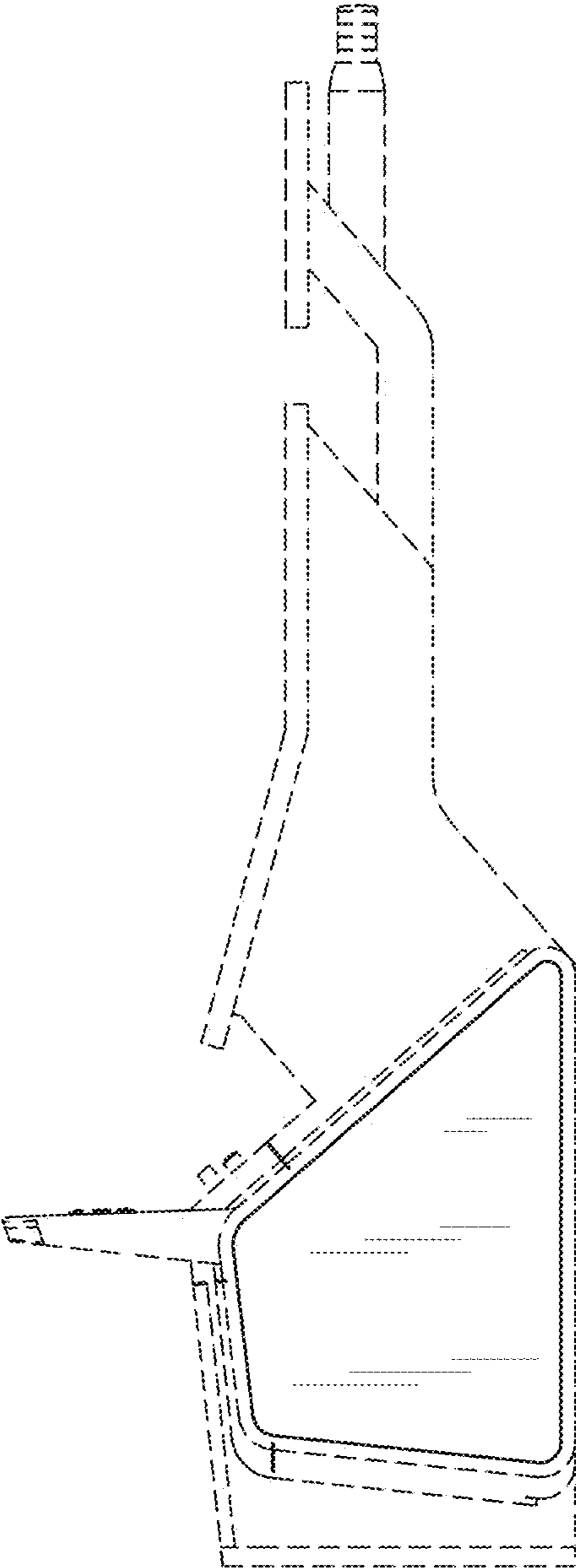

FIG. 13

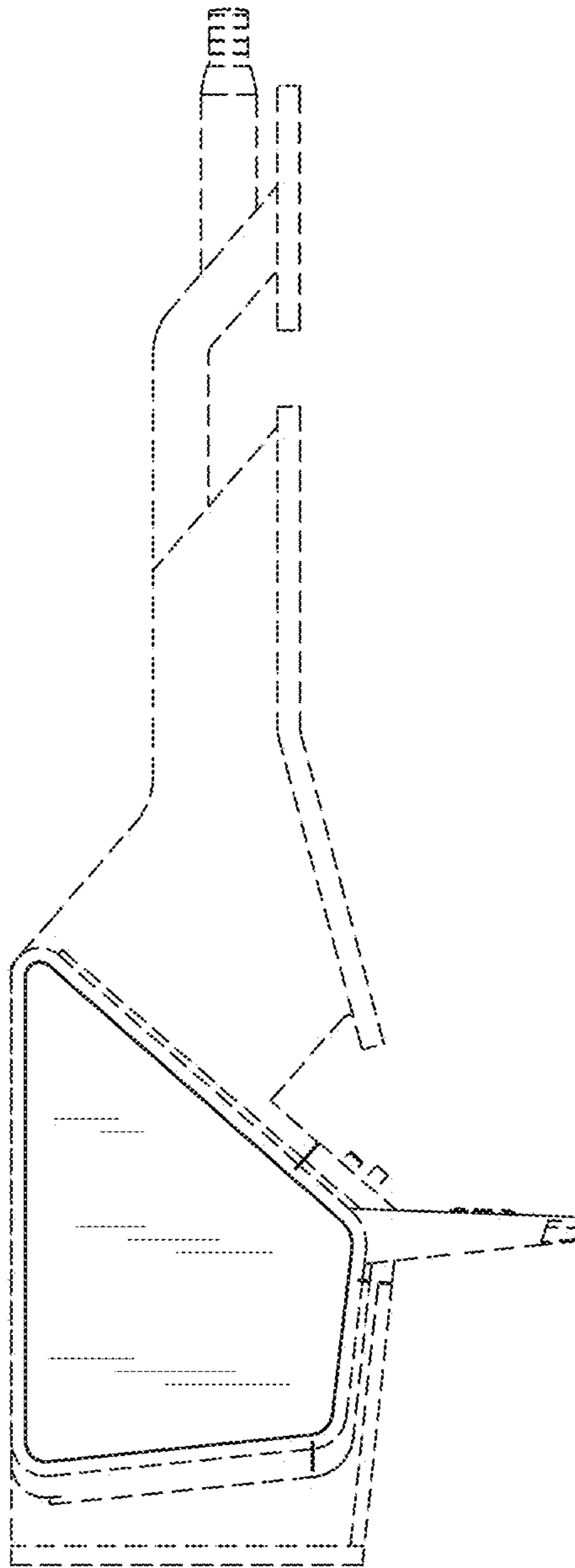

FIG. 14

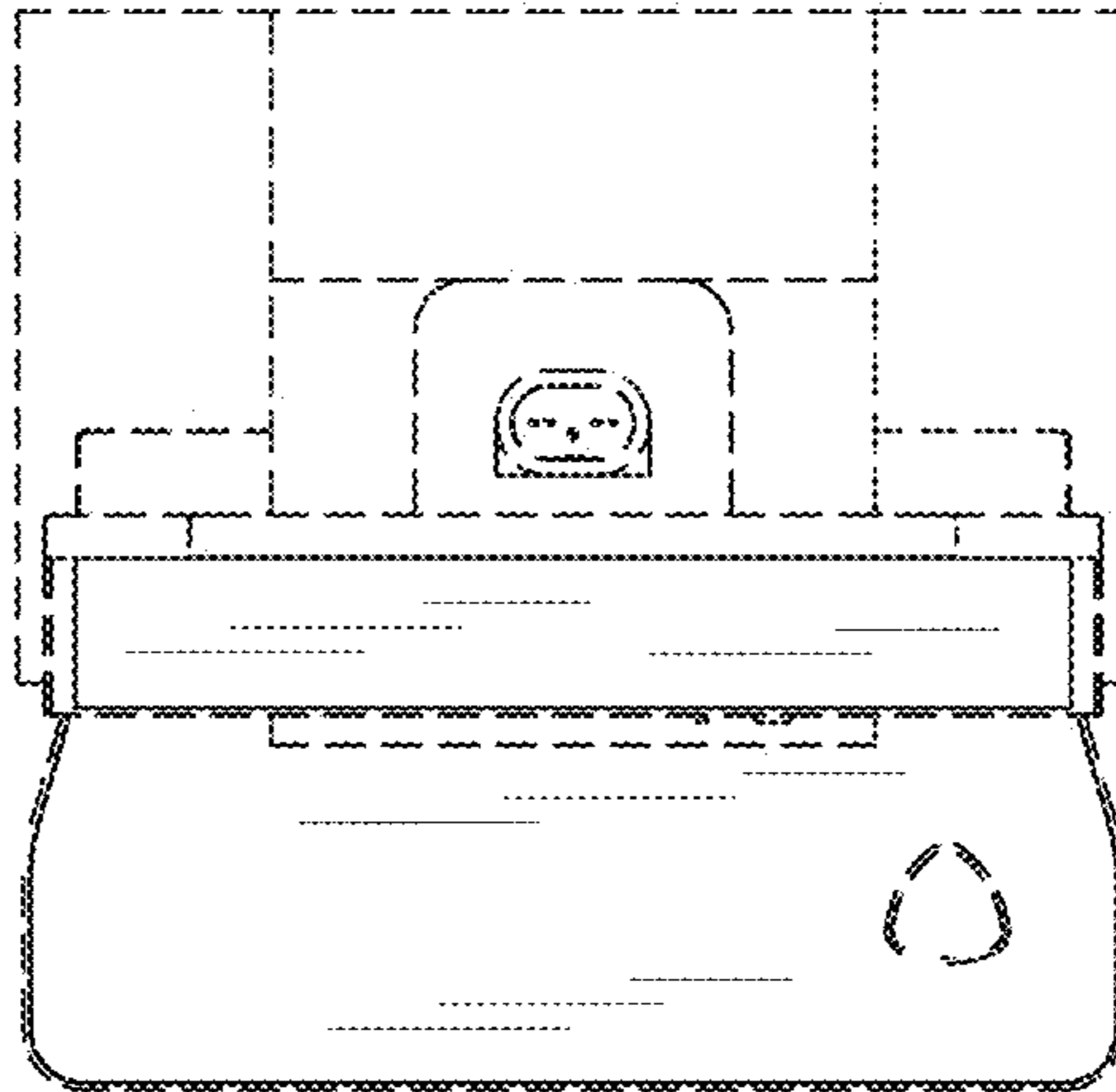

FIG. 15

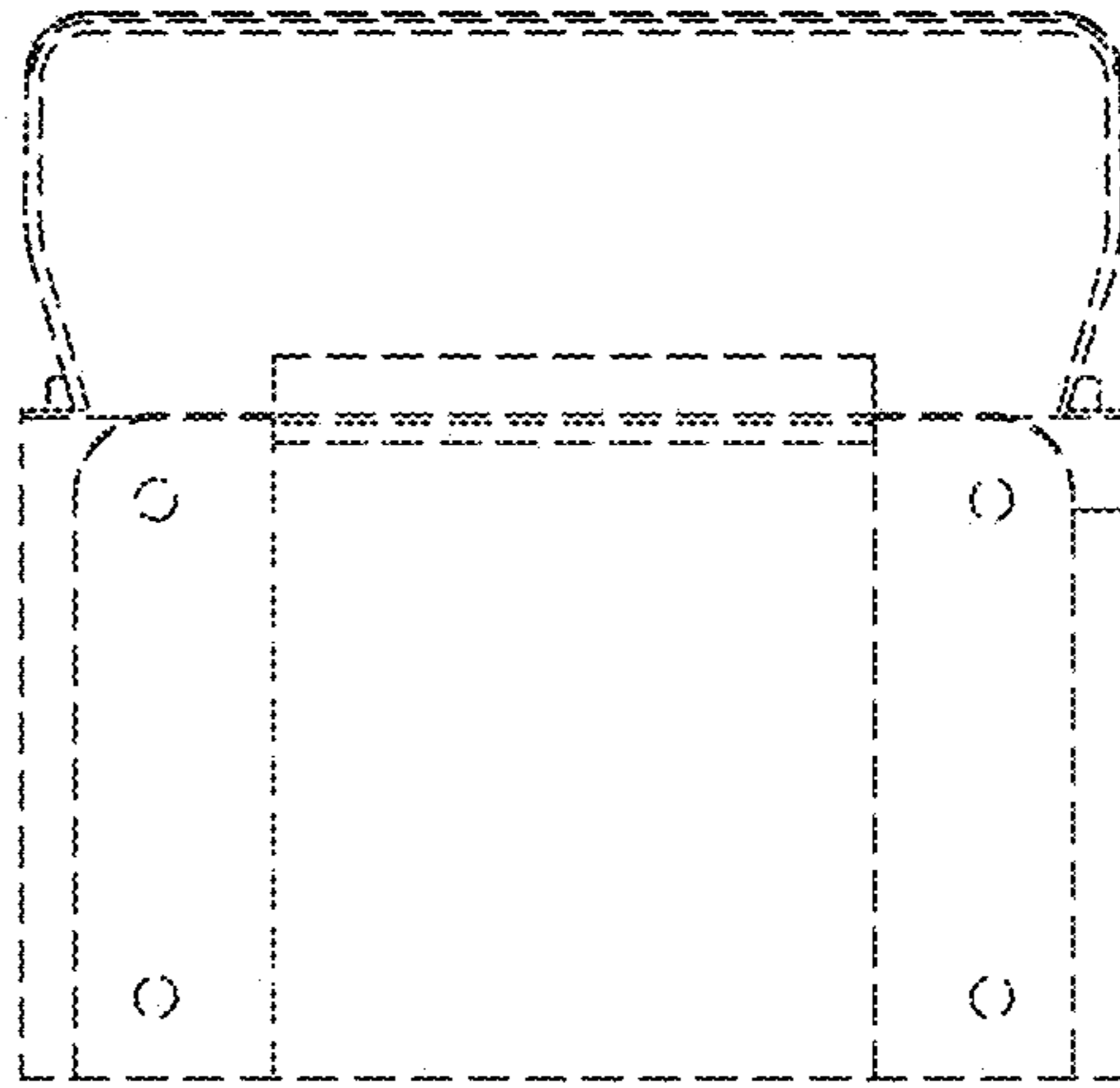

FIG. 16

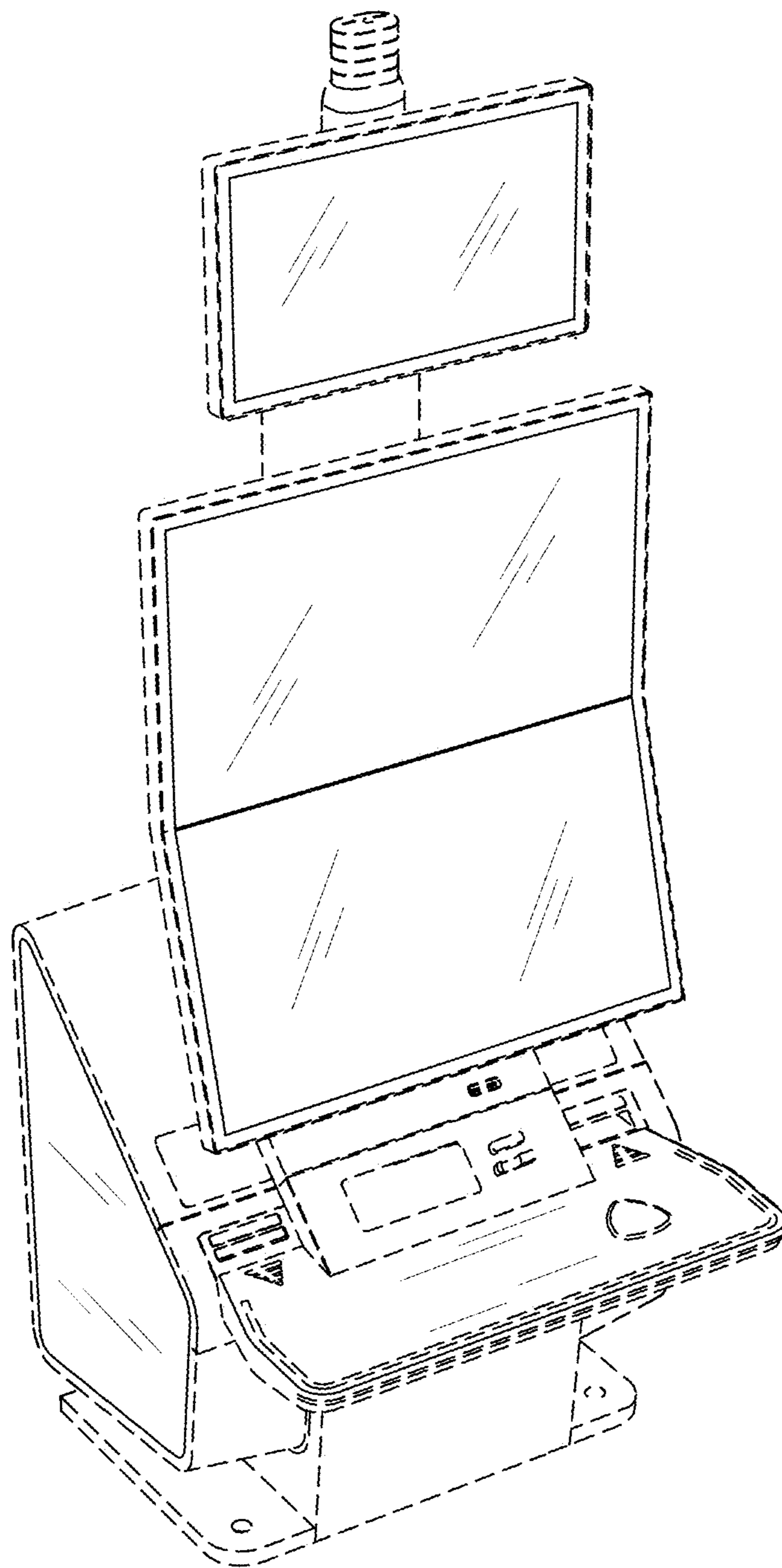

FIG. 17

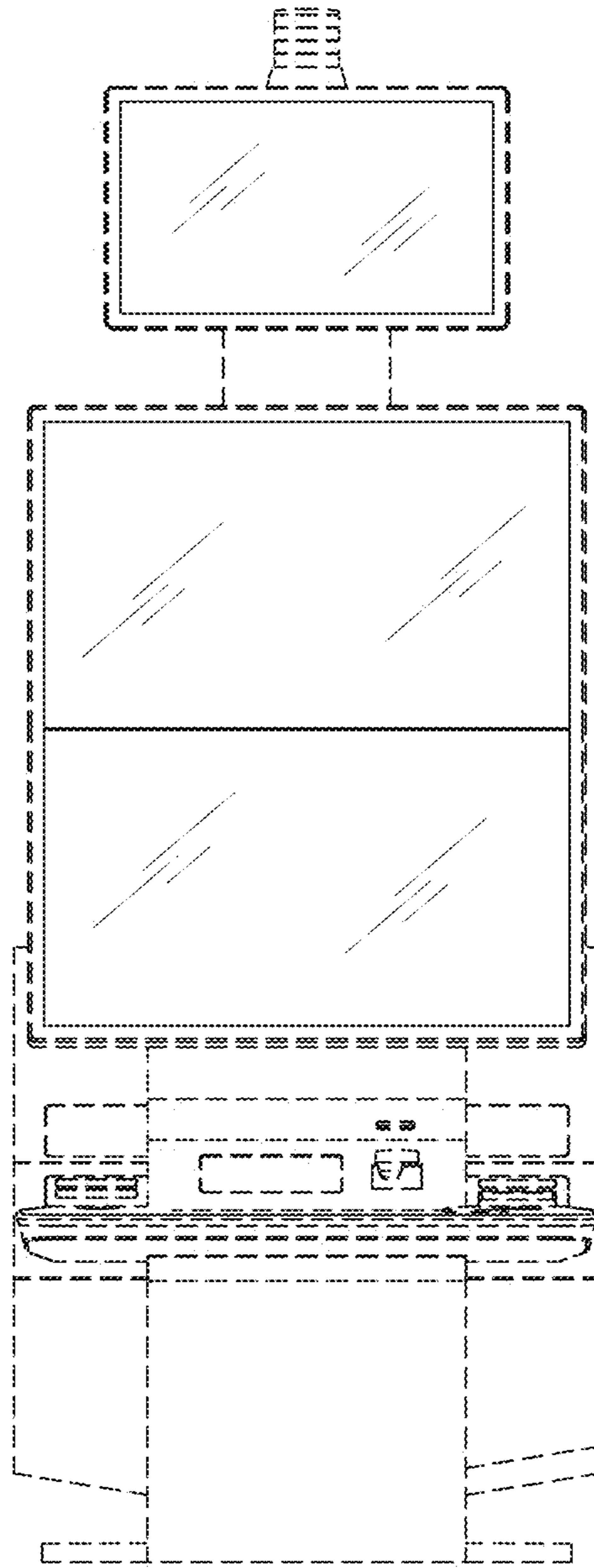

FIG. 18