



US00D907708S

(12) **United States Design Patent** (10) **Patent No.:** **US D907,708 S**
DeMarco et al. (45) **Date of Patent:** **** Jan. 12, 2021**

(54) **GAMING MACHINE**

(71) Applicant: **ARISTOCRAT TECHNOLOGIES AUSTRALIA PTY LIMITED**, North Ryde (AU)

(72) Inventors: **Dominic J. DeMarco**, Round Rock, TX (US); **Bruce Edward Urban**, Las Vegas, NV (US); **James Franklin Stair**, Las Vegas, NV (US); **Ariel David Turgel**, San Francisco, CA (US); **Daniel Harden**, Palo Alto, CA (US); **Alexander Abele**, Aalen (DE)

(73) Assignee: **Aristocrat Technologies Australia Pty Limited**, North Ryde (AU)

(**) Term: **15 Years**

(21) Appl. No.: **29/684,808**

(22) Filed: **Mar. 25, 2019**

(51) **LOC (13) Cl.** **21-03**

(52) **U.S. Cl.**
 USPC **D21/369**

(58) **Field of Classification Search**
 USPC D21/369, 370, 371, 385, 329, 325, 394; D14/307, 172, 129, 325, 401, 371, 126, D14/439, 432, 450, 128, 375, 248, 374, D14/341, 138 G, 127; 463/28, 13, 11, 463/16, 20, 25, 31, 46, 23, 30, 17, 36, 29, 463/42, 34, 32, 35, 19, 21, 22; 273/292, 273/203, 138.2, 143 R, 142 R, 138.1; D19/60; D16/226; D8/335, 331, 334; D26/141; D7/641
 CPC G07F 17/32; G07F 17/34; G07F 17/3211; G07F 17/3244; G07F 17/3267
 See application file for complete search history.

D464,377 S 10/2002 Wurz
 D479,243 S 9/2003 Ohashi
 D508,719 S 8/2005 de Haas
 D513,044 S 12/2005 Morrison
 6,997,810 B2 2/2006 Cole
 D531,677 S 11/2006 Mallory
 D546,893 S 7/2007 Yamashita
 D560,724 S * 1/2008 Johnson D21/329
 D560,725 S * 1/2008 Johnson D21/329
 D562,338 S 2/2008 Keohane
 D572,314 S 7/2008 Vallejo
 D579,456 S 10/2008 Chen
 D587,319 S 2/2009 Moises Deiab
 D599,858 S 9/2009 Lesley
 D599,859 S 9/2009 Lesley
 D604,773 S 11/2009 De Viveiros Ortiz
 D612,432 S 3/2010 De Viveiros Ortiz
 D613,802 S 4/2010 Meyers
 D619,177 S 7/2010 Lee
 D622,781 S 8/2010 Lesley
 D626,182 S 10/2010 Cole
 D628,208 S 11/2010 Potemski
 D646,337 S 10/2011 Kelly
 D652,454 S 1/2012 Yopez
 D666,625 S 9/2012 Gilmore
 D668,261 S 10/2012 Arnold
 D673,620 S 1/2013 Johnson
 D673,621 S 1/2013 Johnson
 D677,736 S * 3/2013 Dorn D21/370
 D678,956 S 3/2013 Lesley
 D679,722 S 4/2013 Ray
 D685,033 S 6/2013 Wudtke
 D689,899 S 9/2013 Lee
 D691,665 S 10/2013 Chudek
 D693,841 S 11/2013 Velasco
 D695,733 S 12/2013 Damhuis
 D697,558 S * 1/2014 Myers D21/325
 D704,273 S 5/2014 Chudek
 D706,741 S 6/2014 Myers
 D707,646 S * 6/2014 Kim D14/138 G
 D713,841 S * 9/2014 Lim D14/341
 8,832,598 B2 9/2014 Hirata
 D719,616 S * 12/2014 Inoue D21/370
 D723,626 S 3/2015 Vasquez
 D727,431 S * 4/2015 Themann D21/370
 D728,585 S 5/2015 Lee
 D730,993 S 6/2015 Castro
 D732,520 S * 6/2015 Themann D14/307
 D734,733 S 7/2015 Park
 D736,171 S 8/2015 Lee
 D740,887 S * 10/2015 Randazzo D21/370
 D740,888 S 10/2015 DePalma
 D742,974 S * 11/2015 Lesley D21/369

(56) **References Cited**
 U.S. PATENT DOCUMENTS
 D415,124 S 10/1999 Rooyakkers
 D428,864 S 8/2000 Rooyakkers

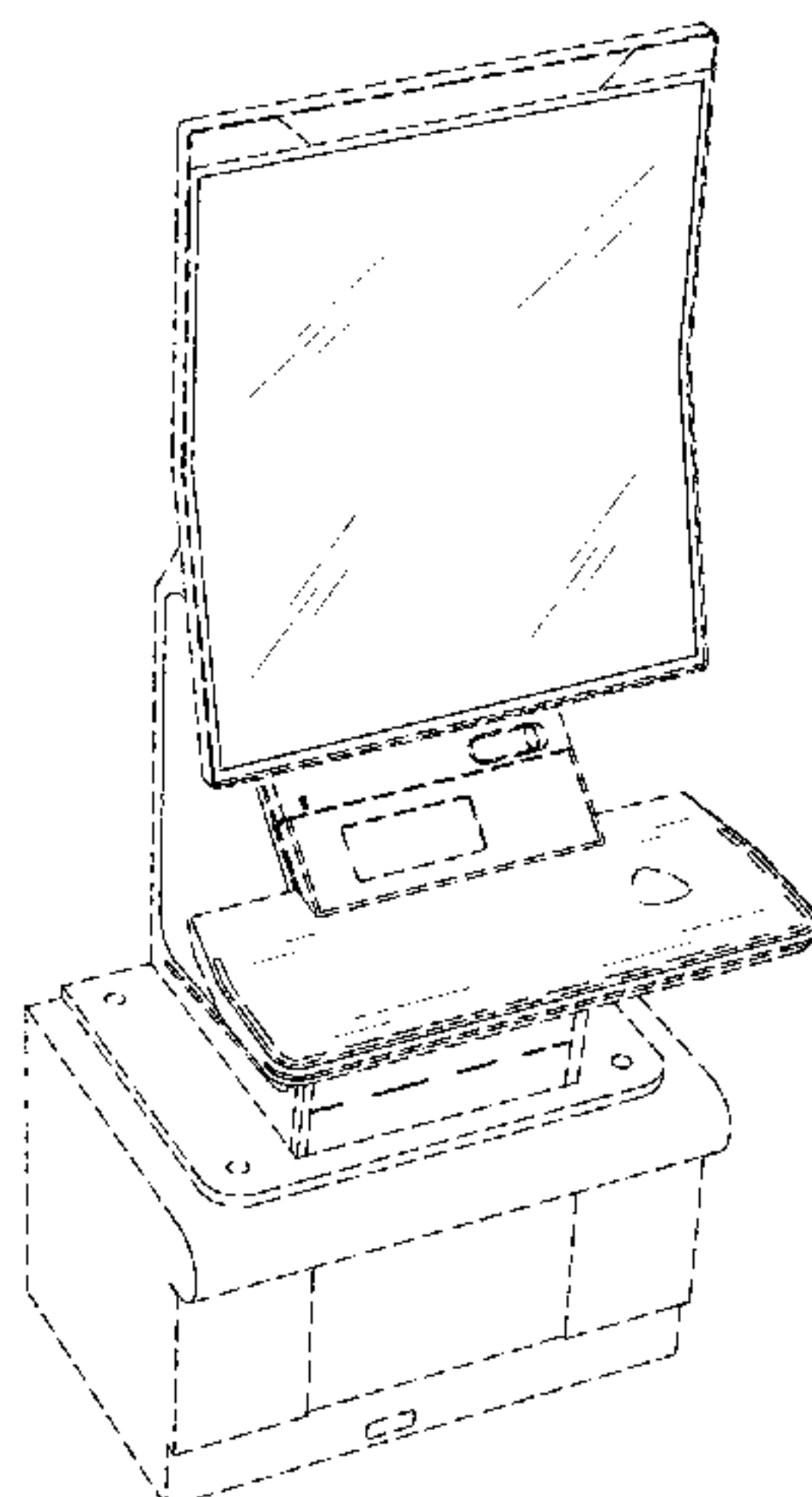

US D907,708 S

D749,342 S	*	2/2016	Escandon	D6/682		D880,614 S	4/2020	Bernard
D759,096 S		6/2016	Seo			D880,615 S	4/2020	Bernard
D760,275 S		6/2016	Zhang			D881,284 S	4/2020	Glenn
D765,136 S		8/2016	Lee			D881,285 S	4/2020	Glenn
RE46,169 E		10/2016	Kelly			D882,697 S	4/2020	Lesley
D772,240 S		11/2016	Edstrom			2013/0084948 A1	4/2013	Watkins
D772,273 S		11/2016	Spector			2014/0335934 A1	11/2014	Meyer
D773,512 S		12/2016	Miura			2015/0018070 A1*	1/2015	Meyer G07F 17/3267
D780,852 S		3/2017	Sharp					463/20
D785,664 S		5/2017	Yao			2015/0036073 A1	2/2015	Im
D790,563 S		6/2017	Lam			2016/0093143 A1	3/2016	Lamb
9,679,435 B2		6/2017	Schrementi			2016/0195938 A1*	7/2016	Kim G06F 3/04886
9,704,337 B2		7/2017	Riggs					345/156
D794,661 S		8/2017	Nishizawa			2017/0039802 A1*	2/2017	Prabhu G07F 17/3211
D794,664 S		8/2017	Okabe			2017/0046906 A1*	2/2017	Hilbert G07F 17/3209
D801,435 S		10/2017	Themann			2017/0092052 A1	3/2017	McKay
D803,323 S		11/2017	Bussey			2017/0301177 A1*	10/2017	Pawloski G07F 17/3244
D803,324 S	*	11/2017	Bussey	D21/370		2018/0075689 A1	3/2018	Castro
D809,068 S		1/2018	Ballman			2018/0078847 A1	3/2018	Sorreta
D809,069 S		1/2018	Ballman			2018/0078854 A1	3/2018	Achmueller
D812,146 S		3/2018	Castro			2018/0082523 A1	3/2018	Palermo
D812,147 S		3/2018	Castro			2019/0012874 A1	1/2019	Goldstein
D812,148 S		3/2018	Castro			2019/0046872 A1*	2/2019	Glenn, II G07F 17/32
D812,149 S		3/2018	Castro			2019/0096161 A1	3/2019	Barbour
D814,455 S	*	4/2018	Kwon	D14/341		2019/0096170 A1	3/2019	Lewis
D816,079 S	*	4/2018	Yamazaki	D14/341		2019/0096173 A1	3/2019	Brandau
D818,048 S		5/2018	Calhoun			2019/0102971 A1	4/2019	Schoonmaker
D819,747 S		6/2018	Castro			2019/0102974 A1	4/2019	Bussey
D820,915 S		6/2018	Lee			2019/0102984 A1	4/2019	Gallagher
D826,338 S		8/2018	Bussey			2019/0287337 A1	9/2019	Shiraishi
D832,356 S		10/2018	Castro			2020/0111291 A1	4/2020	Pariseau
D833,534 S		11/2018	Lee			2020/0111295 A1	4/2020	Glenn
D834,652 S		11/2018	Lee			2020/0111296 A1	4/2020	Miura
10,127,761 B2		11/2018	Woels			2020/0111297 A1	4/2020	Kazama
10,181,236 B2		1/2019	Goldstein			2020/0111328 A1	4/2020	Bland
D843,458 S		3/2019	Castro					
D843,467 S		3/2019	Johnson					
D843,468 S		3/2019	Johnson					
D843,473 S		3/2019	Zedell, Jr.					
D843,474 S		3/2019	Lesley					
D843,475 S		3/2019	Lesley					
D843,476 S		3/2019	Lesley					
D843,477 S		3/2019	Lesley					
D843,478 S		3/2019	Lesley					
D843,479 S		3/2019	Castro					
D843,480 S		3/2019	Castro					
D843,482 S		3/2019	Holland					
D844,062 S		3/2019	Lesley					
D846,650 S		4/2019	Stair					
D847,905 S		5/2019	Lewis					
D849,149 S		5/2019	Bussey					
D849,150 S		5/2019	Gallagher					
D850,536 S		6/2019	Stair					
D850,537 S		6/2019	Urban					
D854,621 S		7/2019	Calhoun					
D858,641 S	*	9/2019	Legras	D21/370				
D858,642 S	*	9/2019	Legras	D21/370				
D859,347 S	*	9/2019	Kwon	D14/138 AB				
D862,602 S		10/2019	Kariya					
D865,066 S		10/2019	Ortiz De Viveiros					
D865,873 S		11/2019	Lewis					
D866,666 S		11/2019	Ditton					
D866,667 S		11/2019	Stair					
D866,668 S		11/2019	Ditton					
D868,165 S		11/2019	Ortiz De Viveiros					
D870,818 S		12/2019	Curbbun					
D870,820 S		12/2019	Urban					
D871,506 S		12/2019	Castro					
D871,507 S		12/2019	Urban					
D872,190 S		1/2020	Zedell, Jr.					
D875,091 S	*	2/2020	Kwon	D14/341				
10,580,252 B2		3/2020	Whelan					
D880,605 S		4/2020	Bussey					
D880,606 S		4/2020	Glenn, II					
D880,608 S		4/2020	Glenn, II					
D880,610 S		4/2020	Glenn, II					
D880,611 S		4/2020	Glenn, II					
D880,612 S		4/2020	Bernard					
D880,613 S		4/2020	Bernard					

OTHER PUBLICATIONS

Office Action dated Jun. 1, 2020 for U.S. Appl. No. 29/684,812 (pp. 1-9).

Office Action dated Jun. 1, 2020 for U.S. Appl. No. 29/684,832 (pp. 1-9).

Office Action dated Jun. 1, 2020 for U.S. Appl. No. 29/684,836 (pp. 1-9).

Office Action dated Jun. 1, 2020 for U.S. Appl. No. 29/684,844 (pp. 1-9).

Office Action dated Jun. 1, 2020 for U.S. Appl. No. 29/684,849 (pp. 1-9).

Office Action dated Jun. 5, 2020 for U.S. Appl. No. 29/684,847 (pp. 1-9).

Office Action dated Jun. 12, 2020 for U.S. Appl. No. 29/684,810 (pp. 1-10).

Office Action dated Jun. 12, 2020 for U.S. Appl. No. 29/684,814 (pp. 1-10).

Office Action dated Jun. 12, 2020 for U.S. Appl. No. 29/684,817 (pp. 1-11).

Office Action dated Jun. 12, 2020 for U.S. Appl. No. 29/684,838 (pp. 1-11).

Office Action dated Jun. 12, 2020 for U.S. Appl. No. 29/684,842 (pp. 1-11).

Office Action dated Jun. 12, 2020 for U.S. Appl. No. 29/684,883 (pp. 1-8).

Office Action dated Jun. 12, 2020 for U.S. Appl. No. 29/684,890 (pp. 1-9).

Office Action dated Jun. 12, 2020 for U.S. Appl. No. 29/684,891 (pp. 1-9).

Office Action dated Jun. 12, 2020 for U.S. Appl. No. 29/684,894 (pp. 1-10).

Office Action dated Jun. 12, 2020 for U.S. Appl. No. 29/684,899 (pp. 1-9).

Office Action dated Jun. 12, 2020 for U.S. Appl. No. 29/684,915 (pp. 1-10).

Office Action dated Jun. 12, 2020 for U.S. Appl. No. 29/684,922 (pp. 1-10).

Office Action dated Jun. 12, 2020 for U.S. Appl. No. 29/684,925 (pp. 1-10).
Office Action dated Jun. 12, 2020 for U.S. Appl. No. 29/684,929 (pp. 1-10).
Office Action dated Jun. 12, 2020 for U.S. Appl. No. 29/684,934 (pp. 1-10).
Office Action dated Jun. 12, 2020 for U.S. Appl. No. 29/684,936 (pp. 1-10).
Office Action dated Jun. 12, 2020 for U.S. Appl. No. 29/684,941 (pp. 1-12).
Office Action dated Jul. 10, 2020 for U.S. Appl. No. 29/684,900 (pp. 1-10).
Office Action dated Jul. 10, 2020 for U.S. Appl. No. 29/684,938 (pp. 1-13).
Notice of Allowance dated Aug. 5, 2020 for U.S. Appl. No. 29/678,496 (pp. 1-7).
Office Action dated Jun. 1, 2020 for U.S. Appl. No. 29/684,806 (pp. 1-9).
Office Action dated Jun. 1, 2020 for U.S. Appl. No. 29/684,807 (pp. 1-8).
Office Action dated Jun. 1, 2020 for U.S. Appl. No. 29/684,809 (pp. 1-7).
Office Action dated Jun. 1, 2020 for U.S. Appl. No. 29/684,811 (pp. 1-7).
Office Action dated Jun. 12, 2020 for U.S. Appl. No. 29/684,912 (pp. 1-10).
Corrected Notice of Allowability dated Aug. 17, 2020 for U.S. Appl. No. 29/678,496 (pp. 1-4).

* cited by examiner

Primary Examiner — Ryan Harvey
(74) *Attorney, Agent, or Firm* — Armstrong Teasdale LLP

(57) **CLAIM**

We claim the ornamental design for a gaming machine, as shown and described.

DESCRIPTION

FIG. 1 is a front perspective view of a gaming machine showing our new design;

FIG. 2 is a front view of the gaming machine shown in FIG. 1;
FIG. 3 is a back view of the gaming machine shown in FIG. 1;
FIG. 4 is a right side view of the gaming machine shown in FIG. 1;
FIG. 5 is a left side view of the gaming machine shown in FIG. 1;
FIG. 6 is a top view of the gaming machine shown in FIG. 1;
FIG. 7 is a bottom view of the gaming machine shown in FIG. 1;
FIG. 8 is a front perspective view of a gaming machine showing an alternative embodiment of our new design;
FIG. 9 is a front view of the gaming machine shown in FIG. 8;
FIG. 10 is a front perspective view of a gaming machine showing a further embodiment of our new design;
FIG. 11 is a front view of the gaming machine shown in FIG. 10;
FIG. 12 is a back view of the gaming machine shown in FIG. 10;
FIG. 13 is a right side view of the gaming machine shown in FIG. 10;
FIG. 14 is a left side view of the gaming machine shown in FIG. 10;
FIG. 15 is a top view of the gaming machine shown in FIG. 10;
FIG. 16 is a bottom view of the gaming machine shown in FIG. 10;
FIG. 17 is a front perspective view of a gaming machine showing another alternative embodiment of our new design; and,
FIG. 18 is a front view of the gaming machine shown in FIG. 17.
The broken line showing of portions of the gaming machine depicts environment and forms no part of the claimed design.

1 Claim, 18 Drawing Sheets

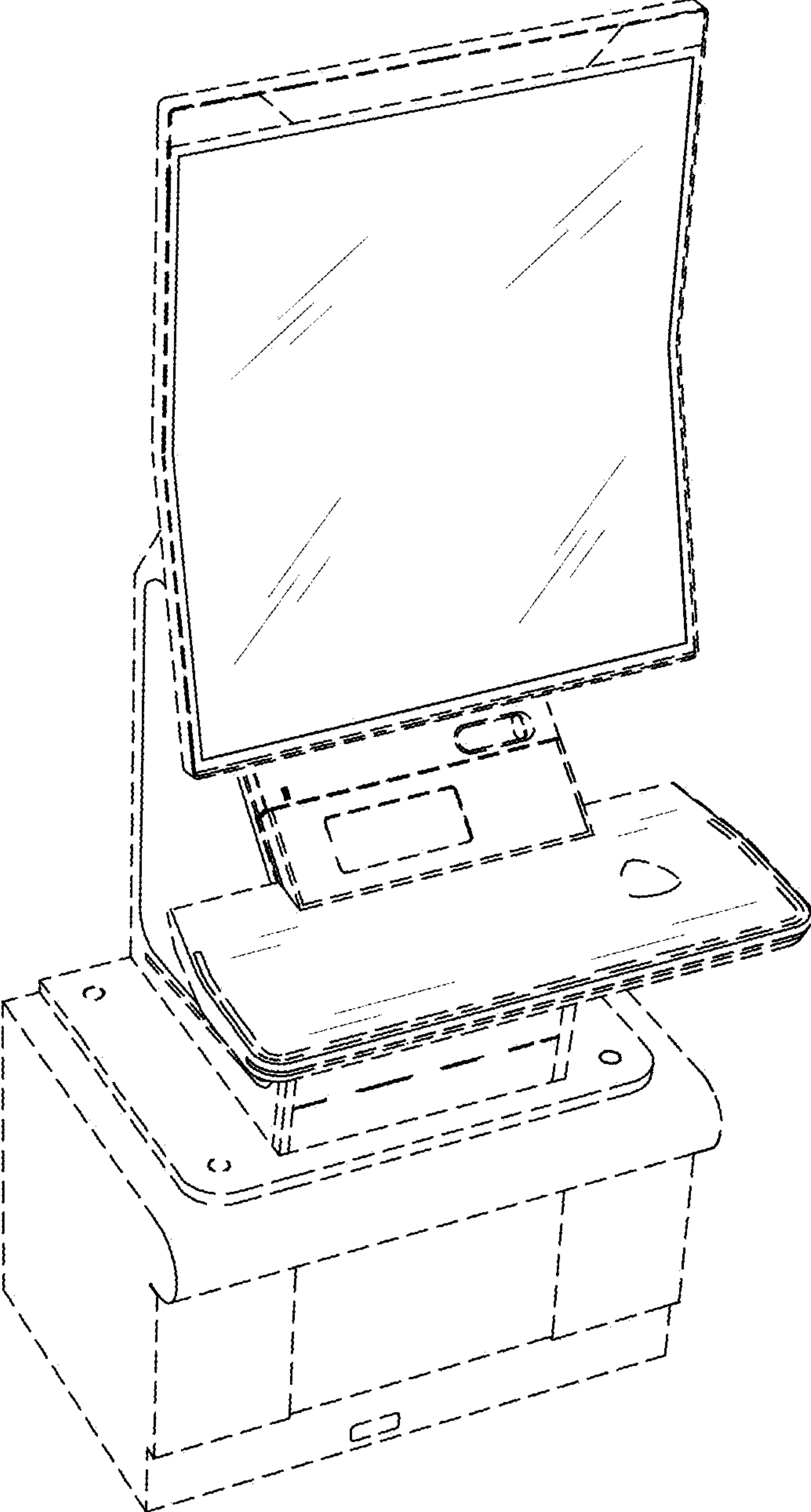

FIG. 1

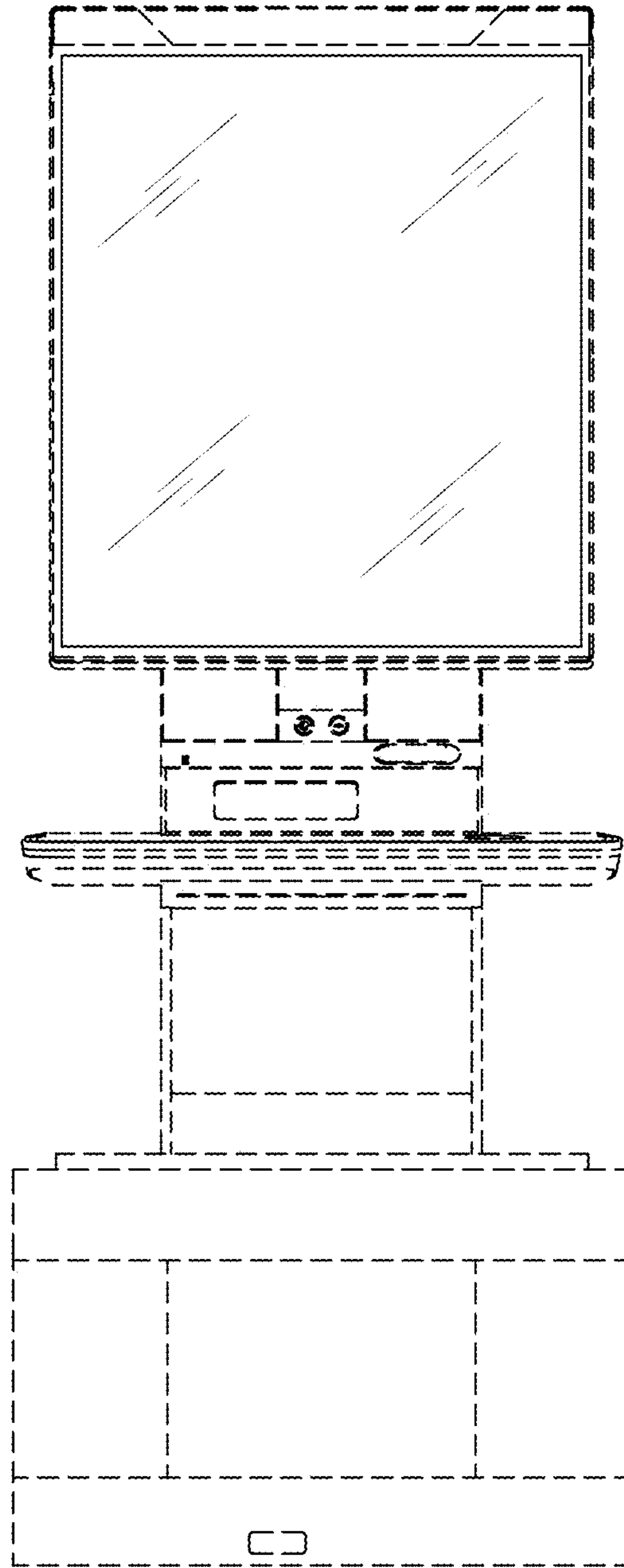

FIG. 2

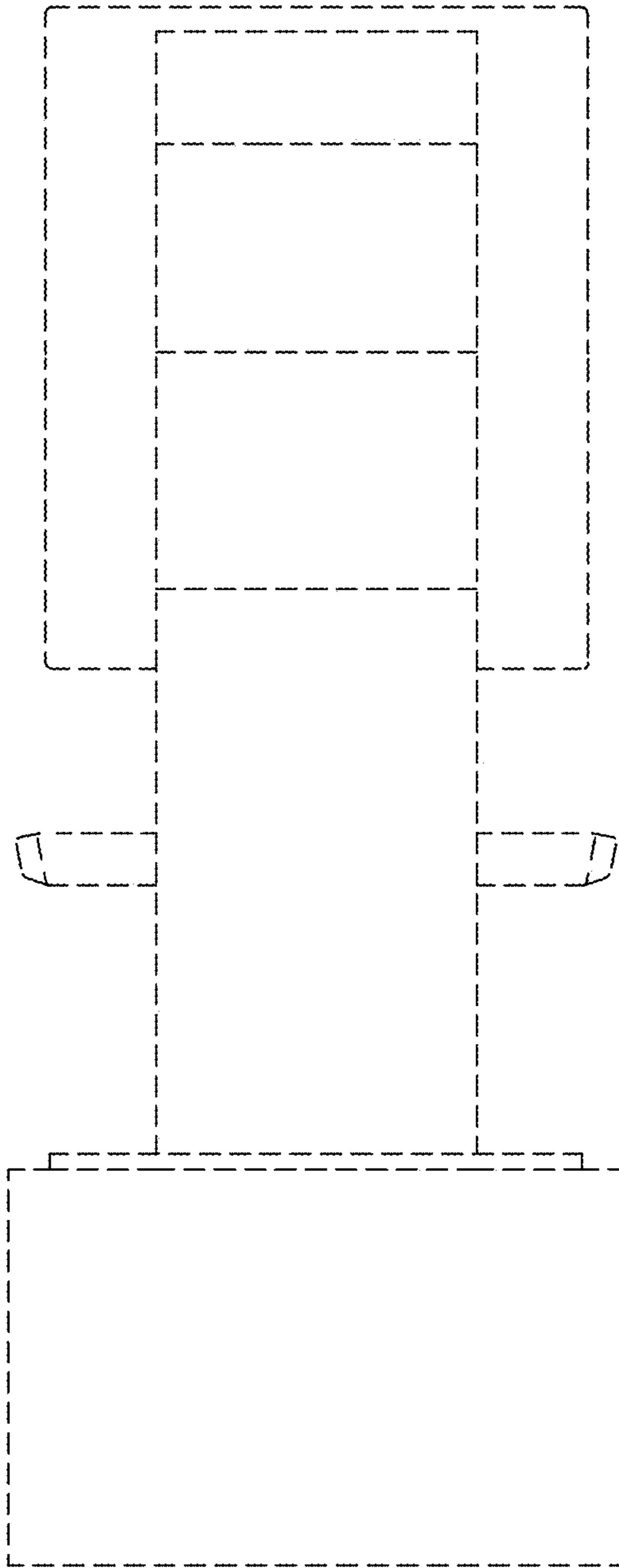

FIG. 3

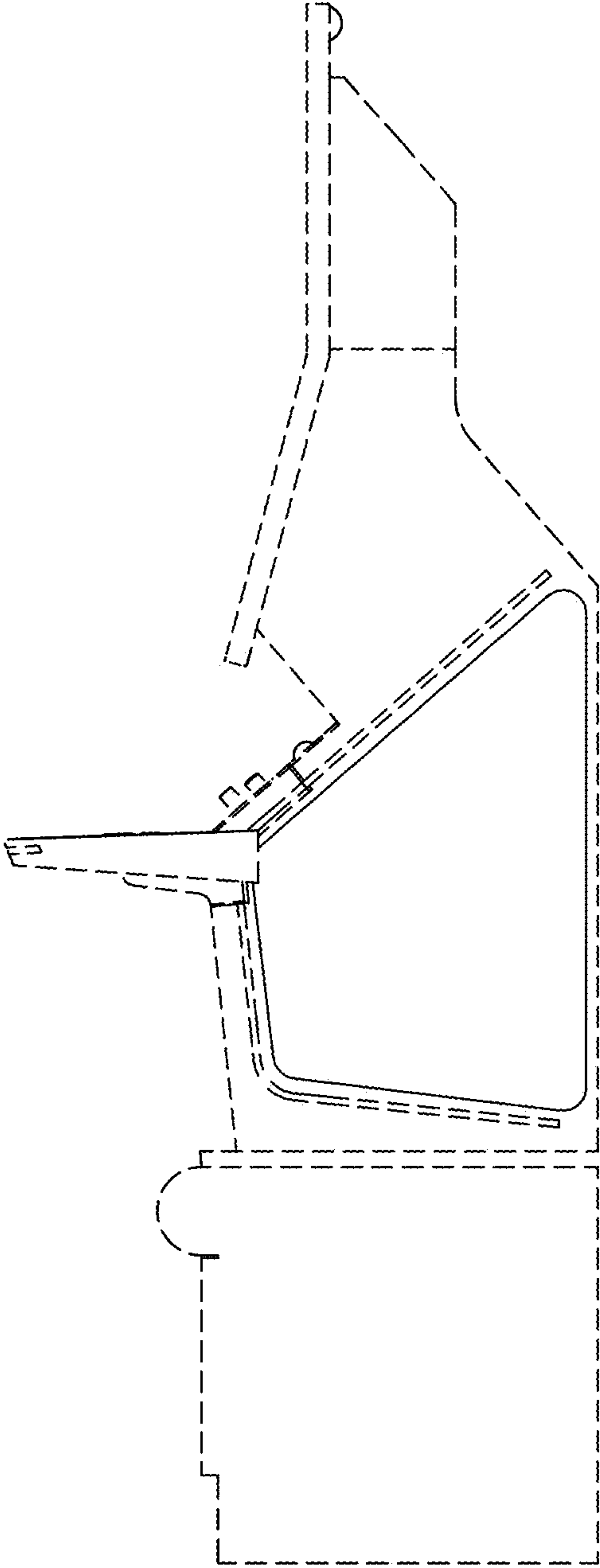

FIG. 4

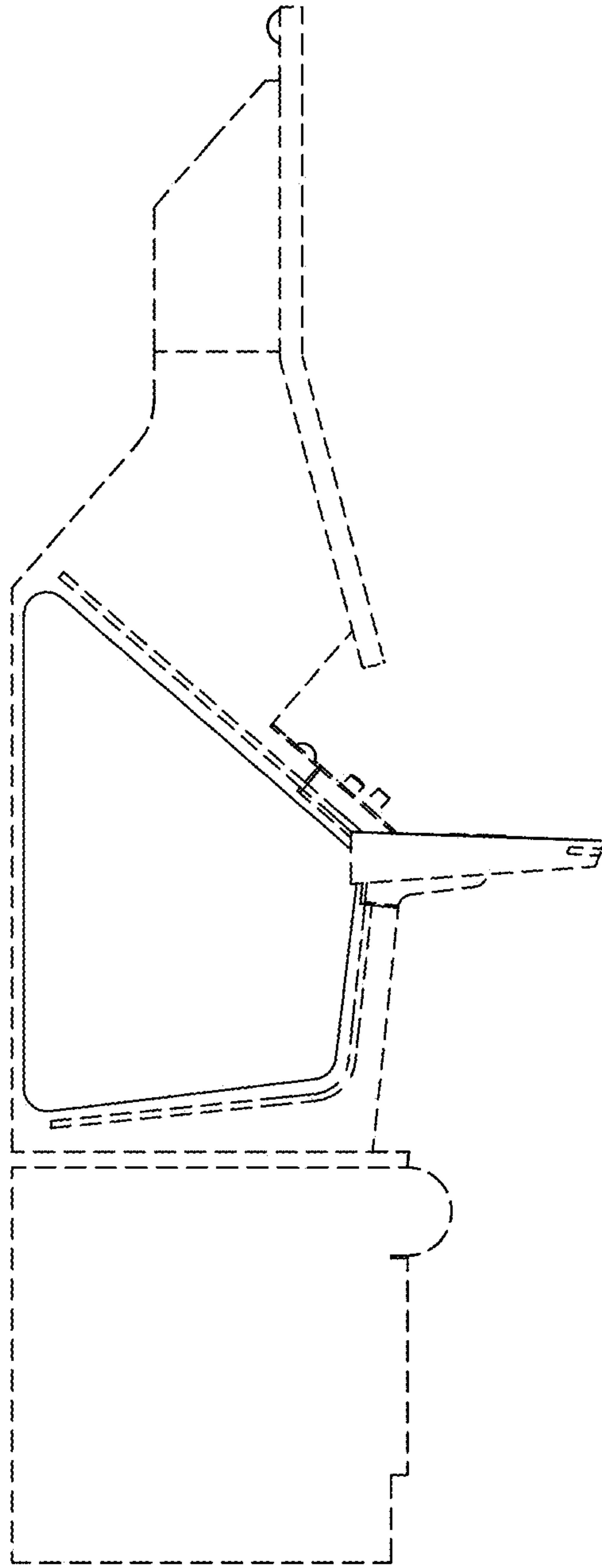

FIG. 5

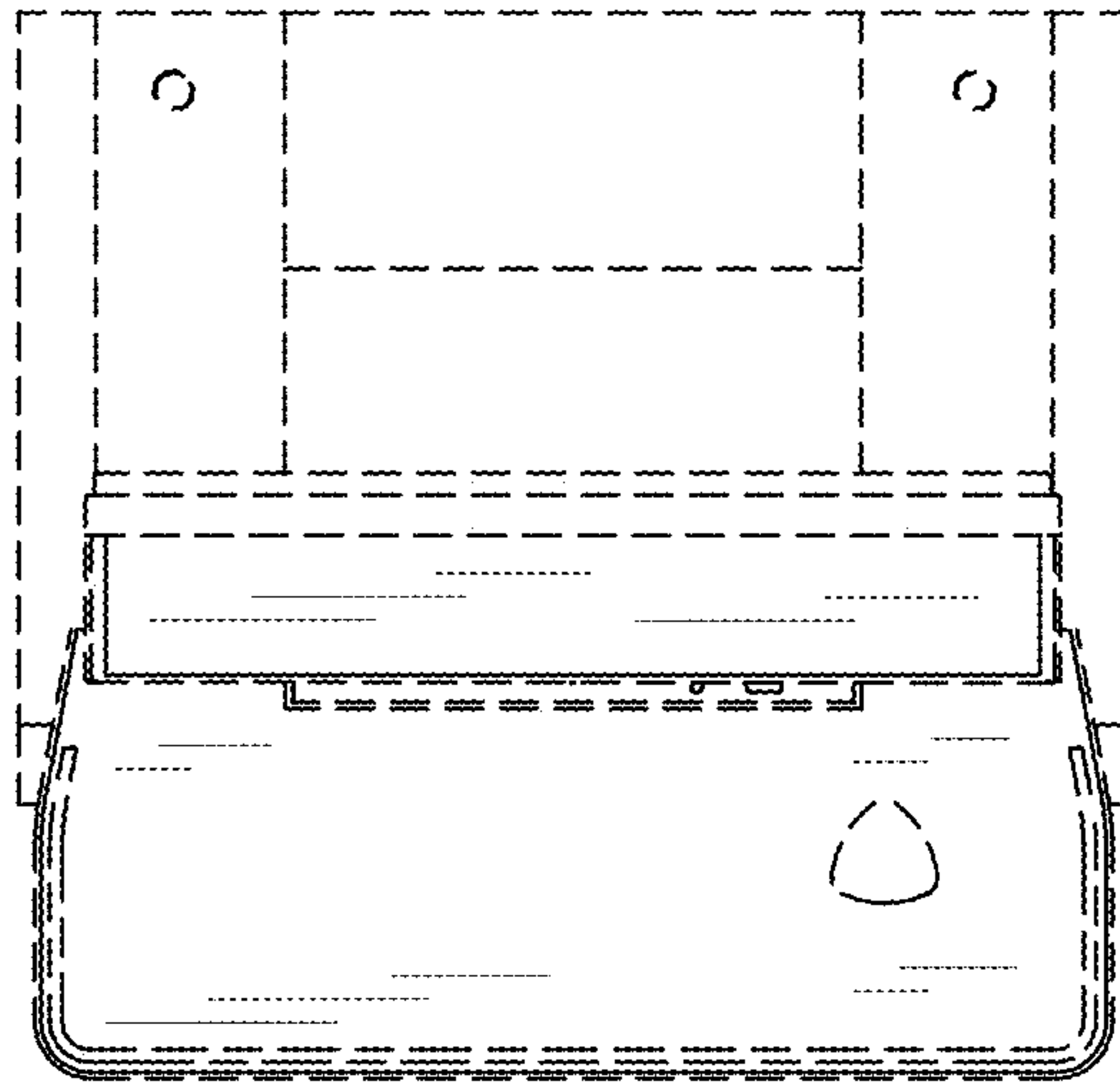

FIG. 6

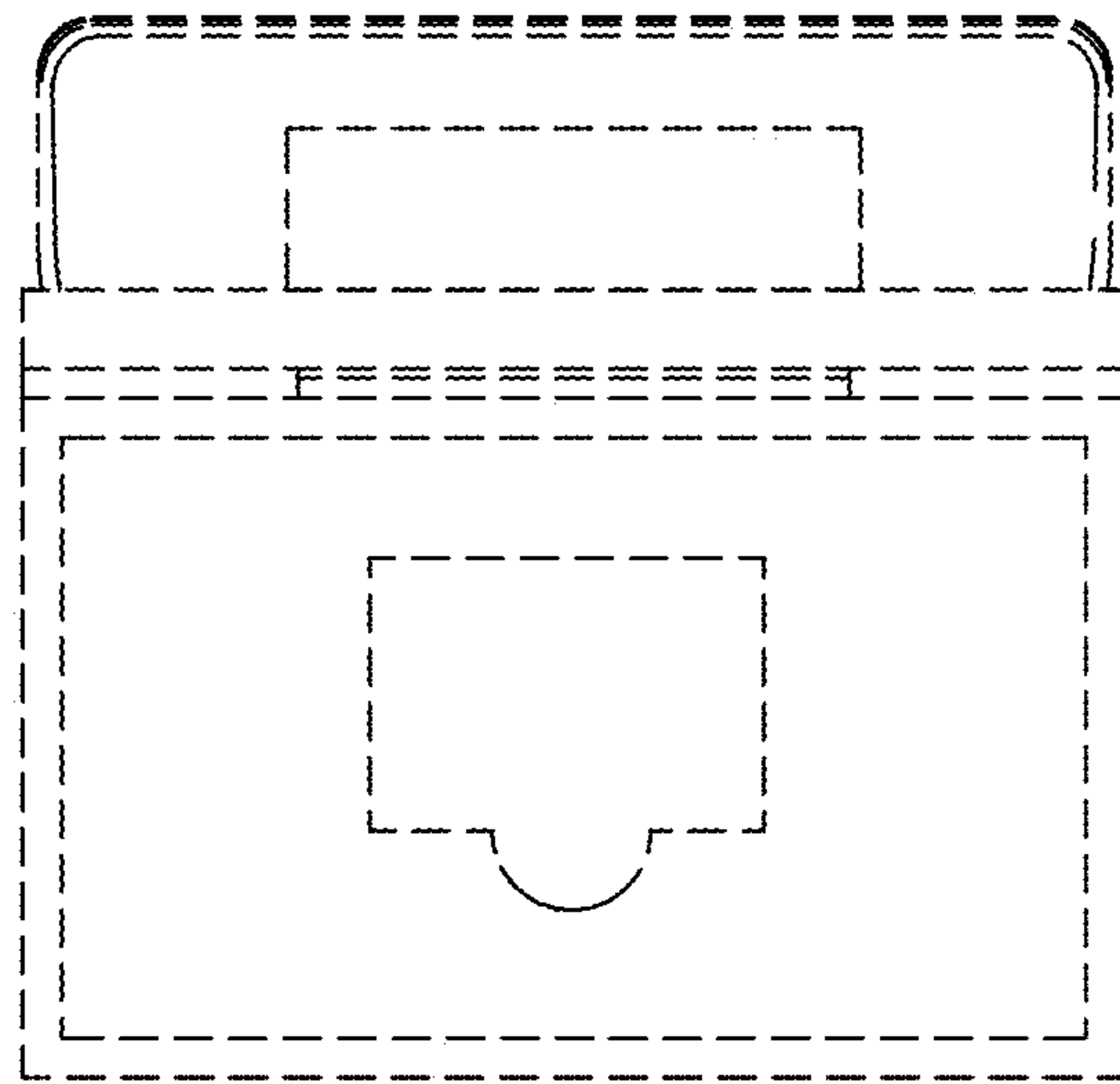

FIG. 7

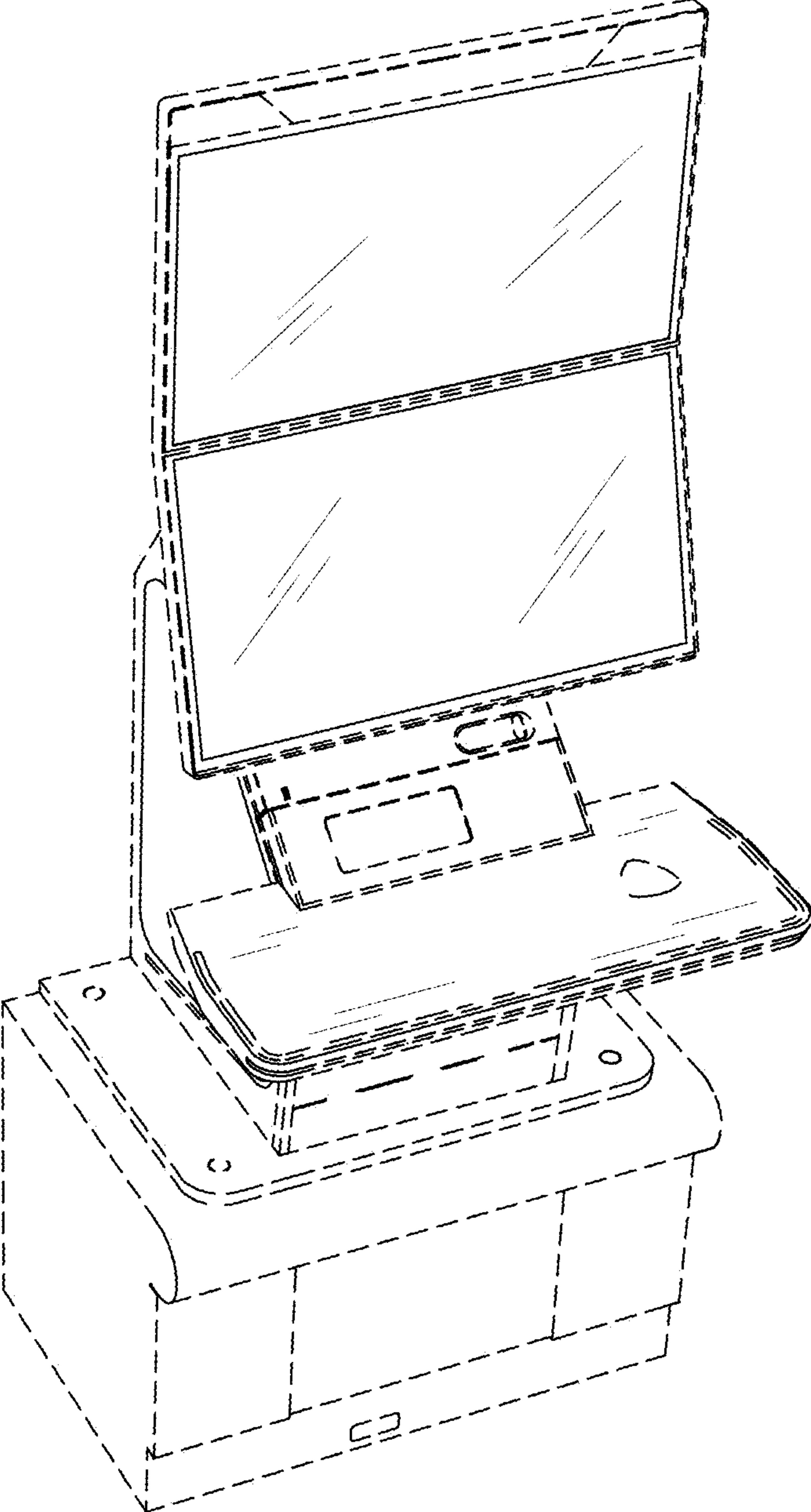

FIG. 8

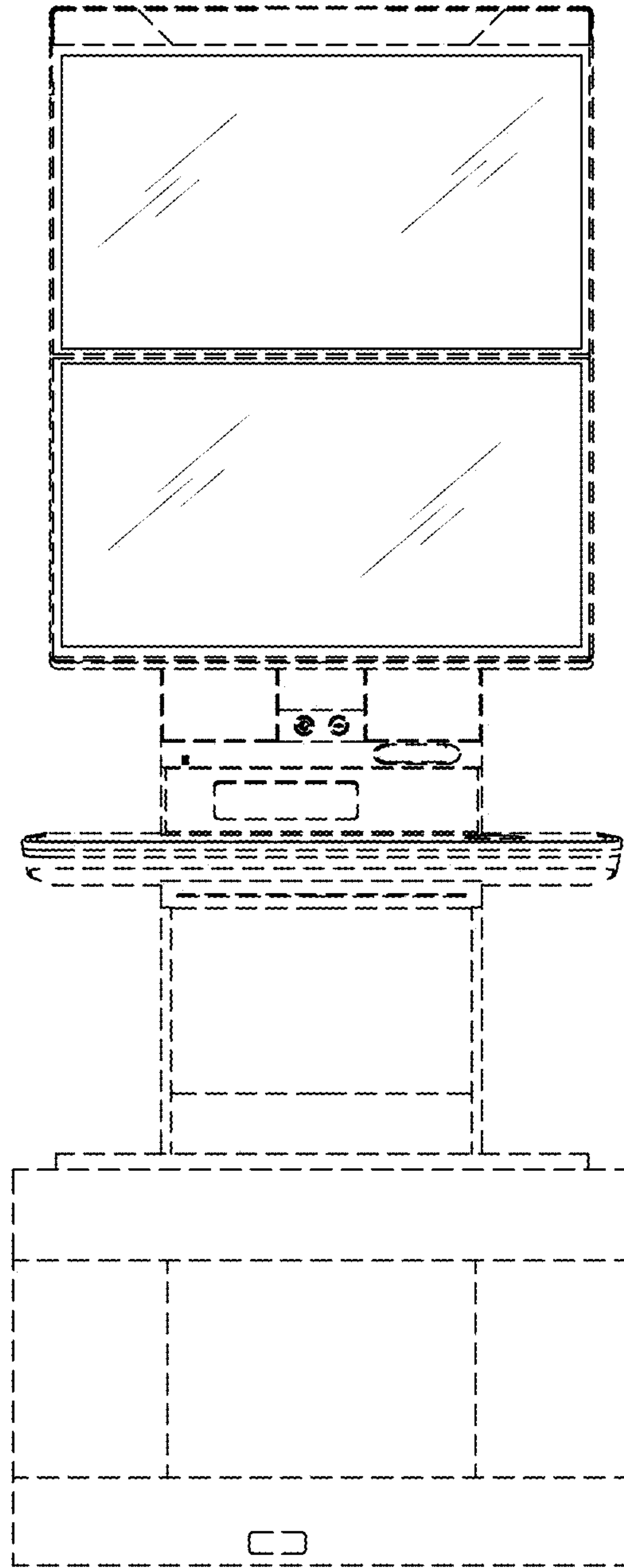

FIG. 9

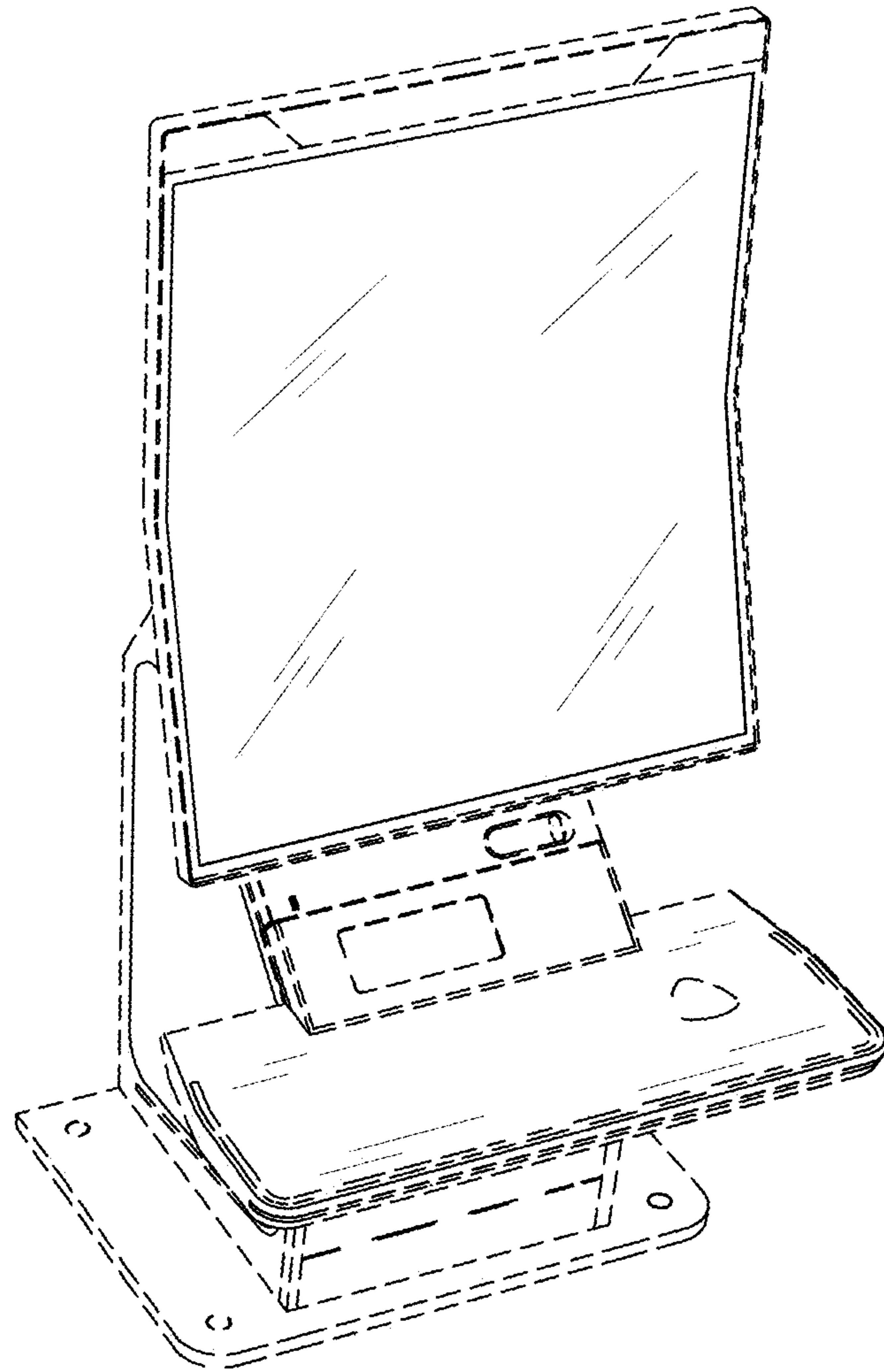

FIG. 10

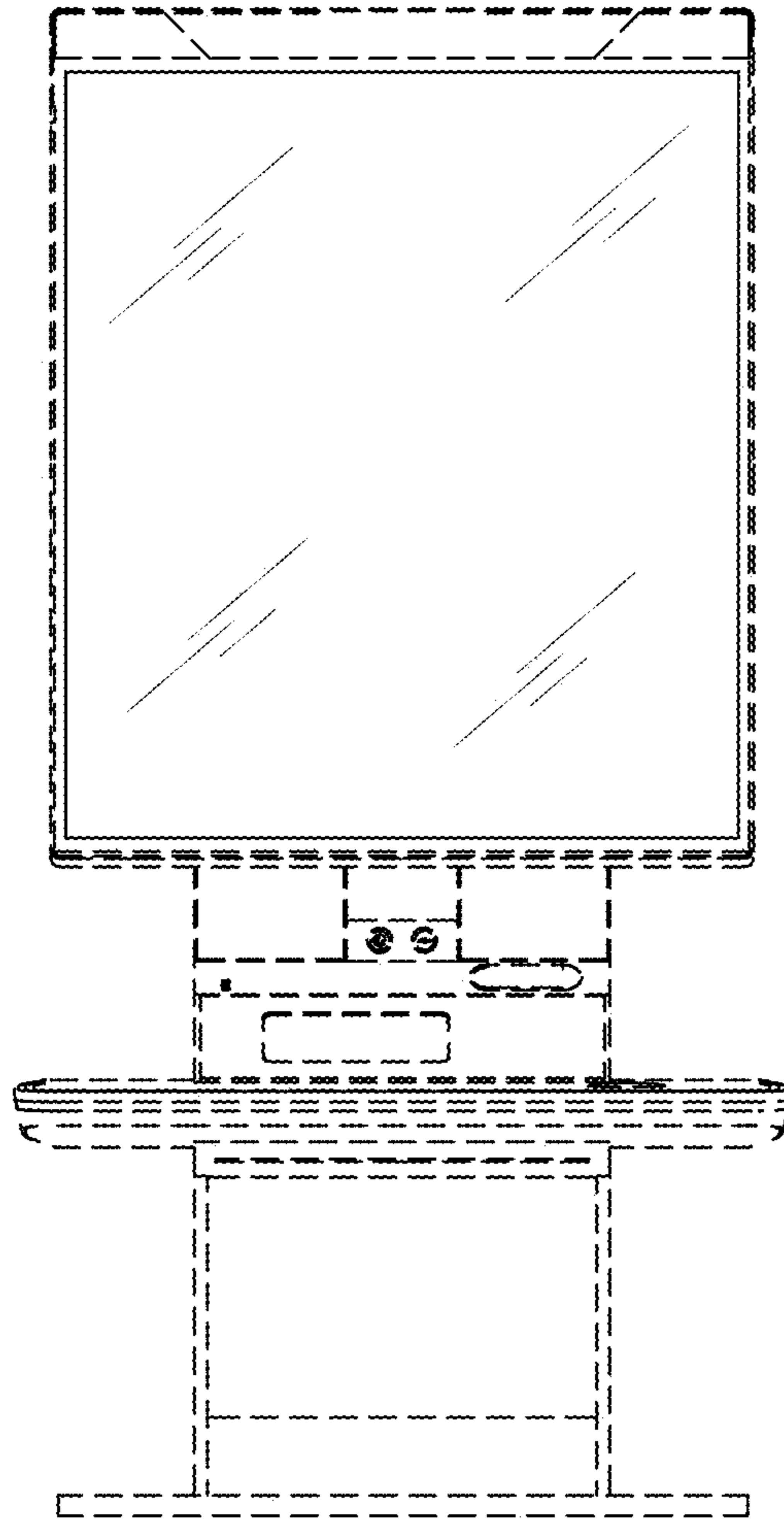

FIG. 11

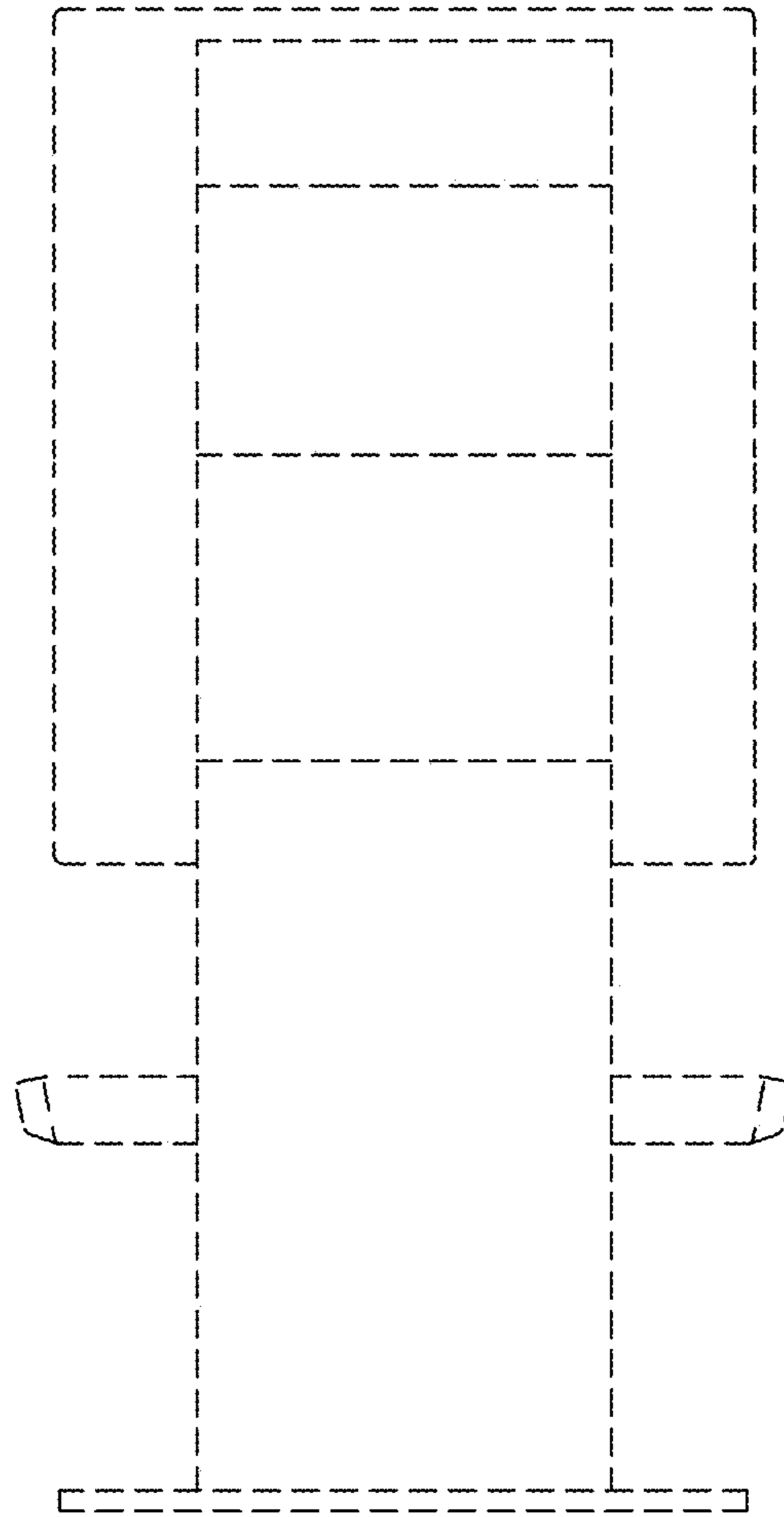

FIG. 12

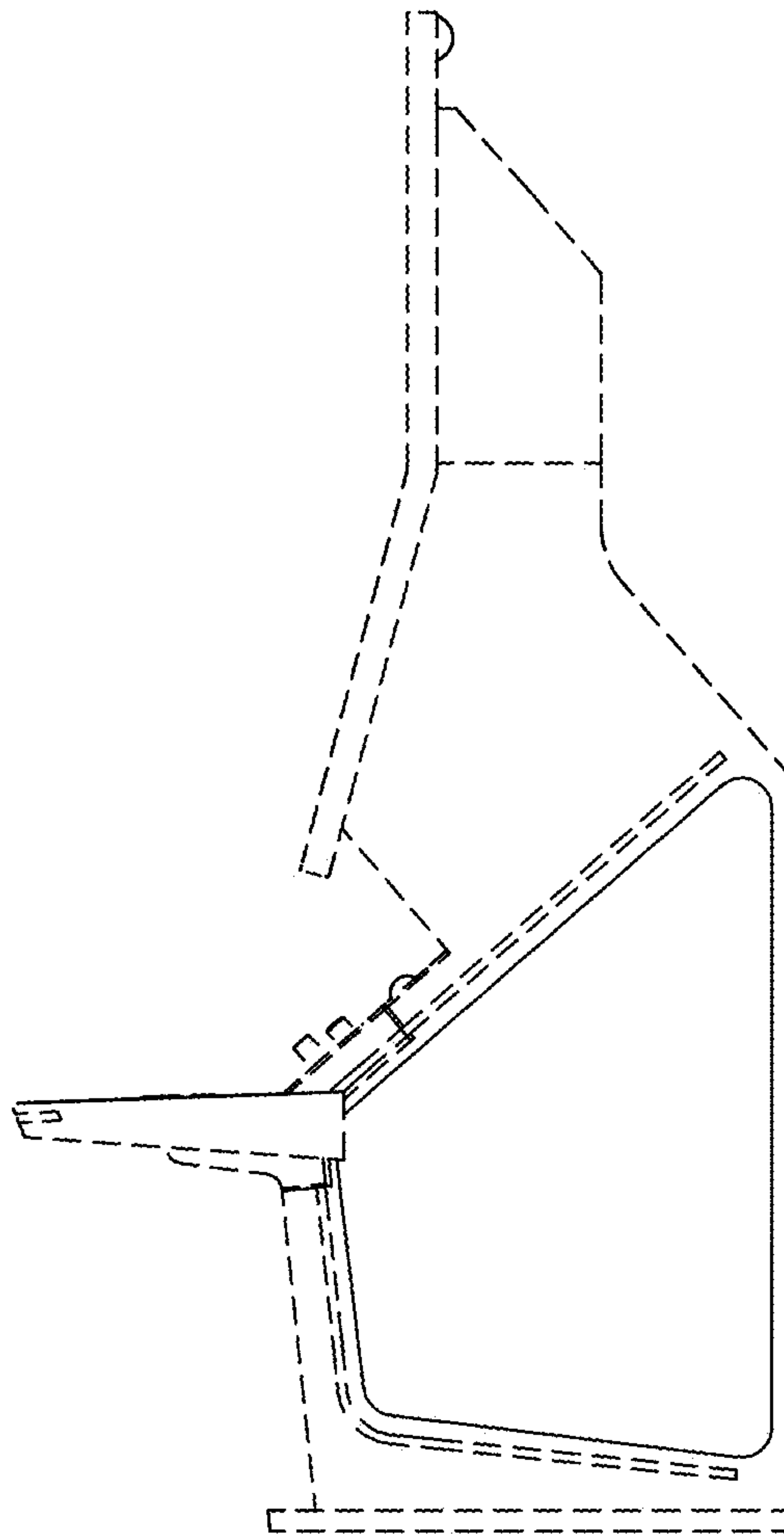

FIG. 13

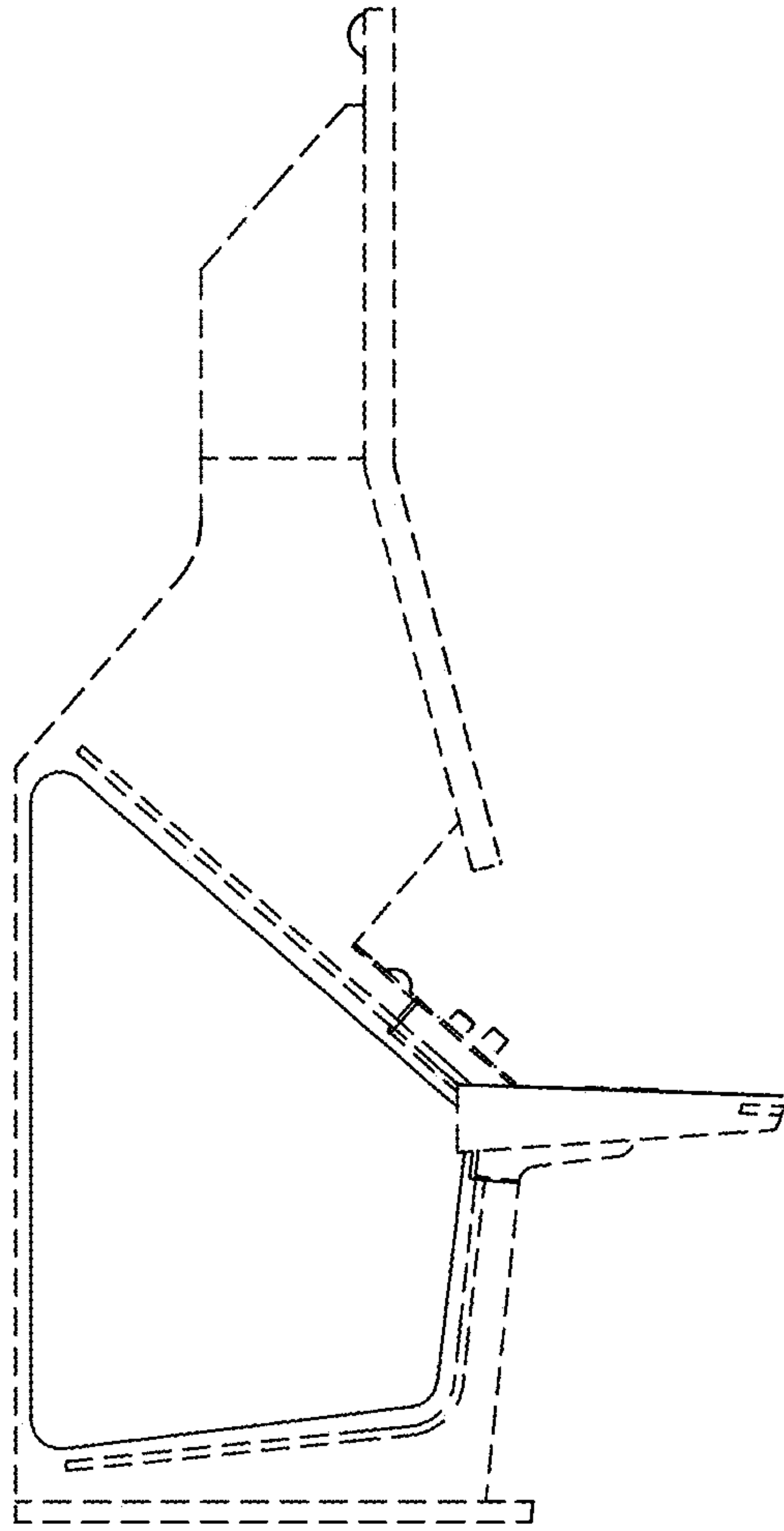

FIG. 14

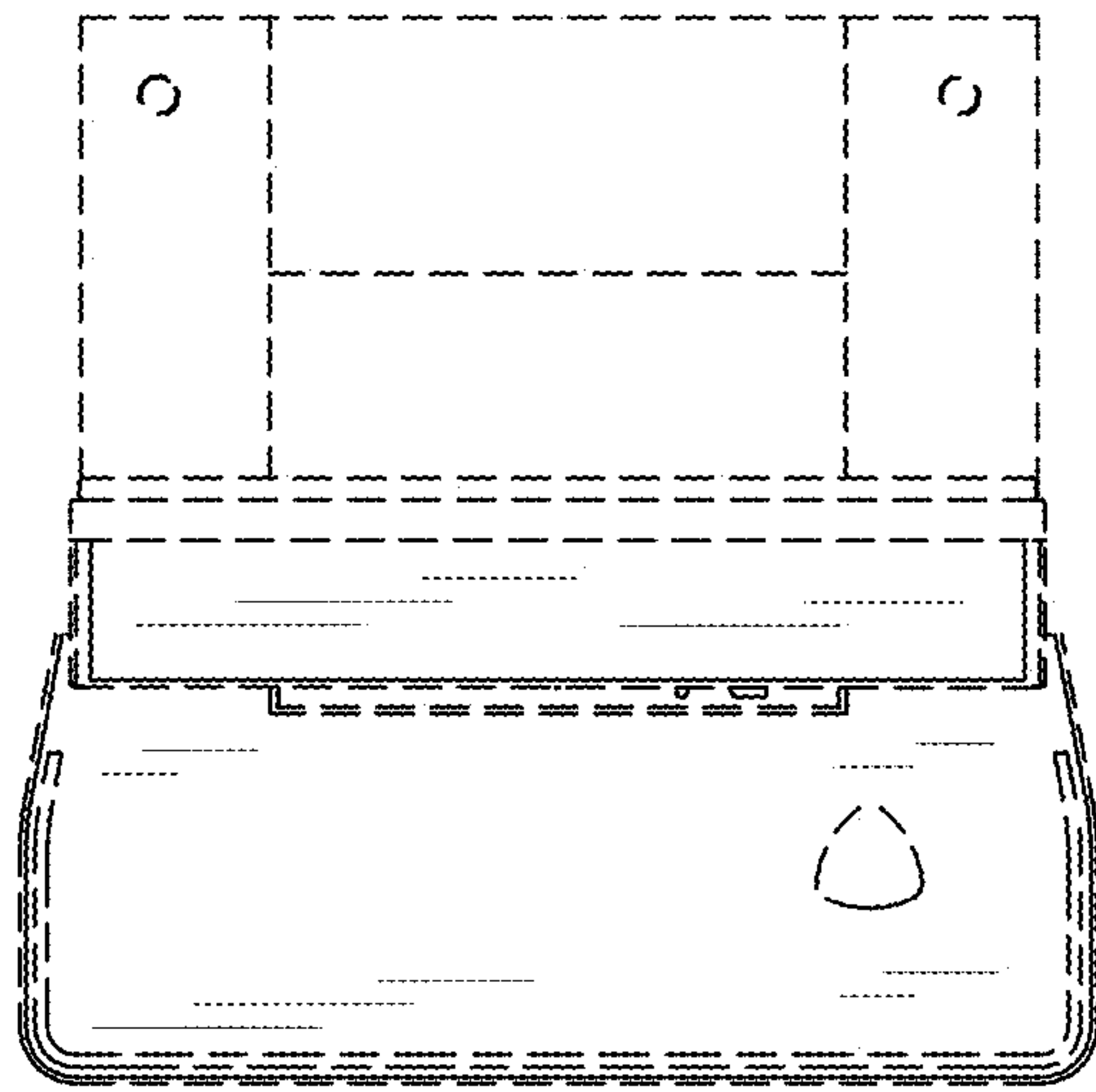

FIG. 15

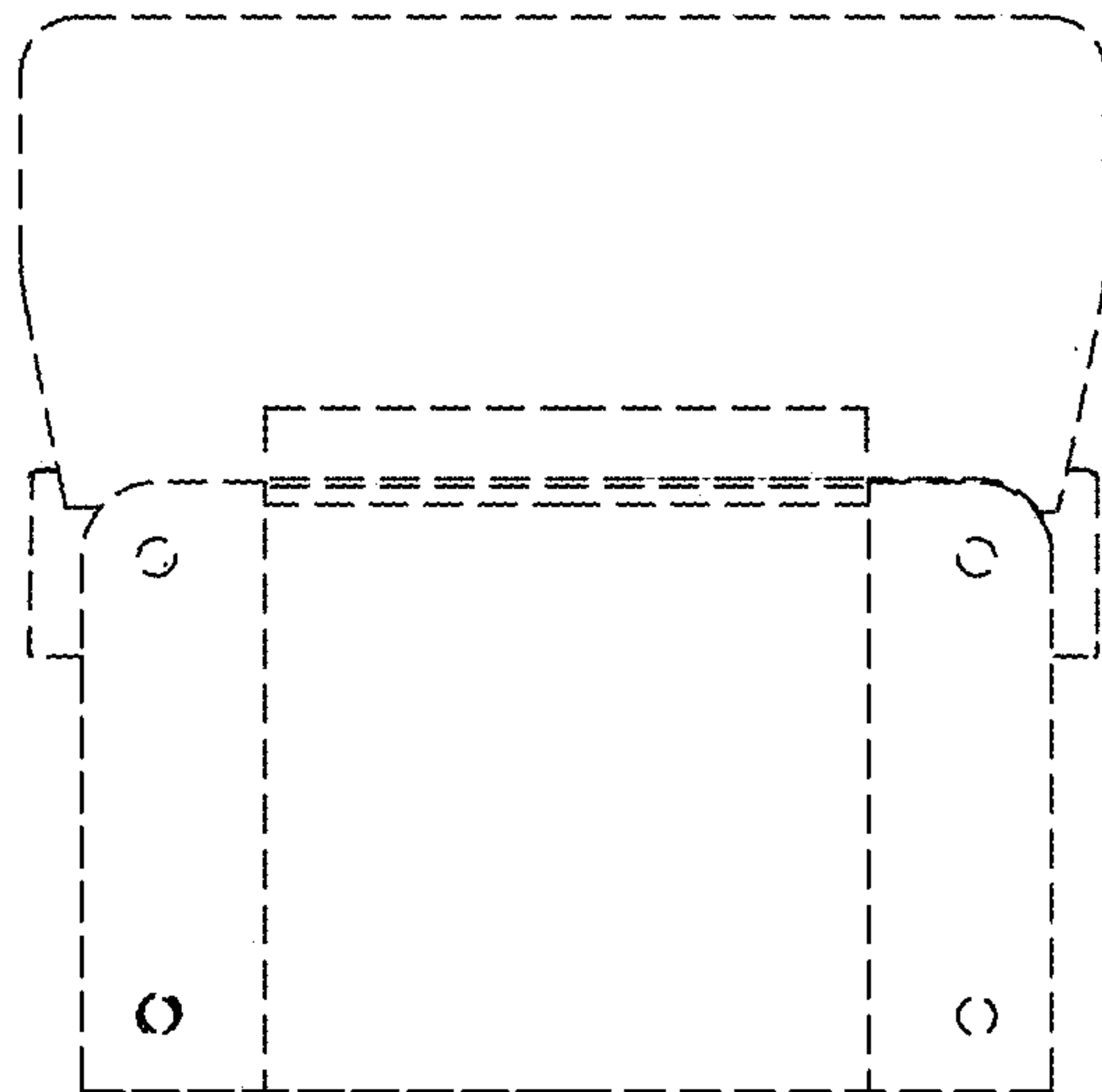

FIG. 16

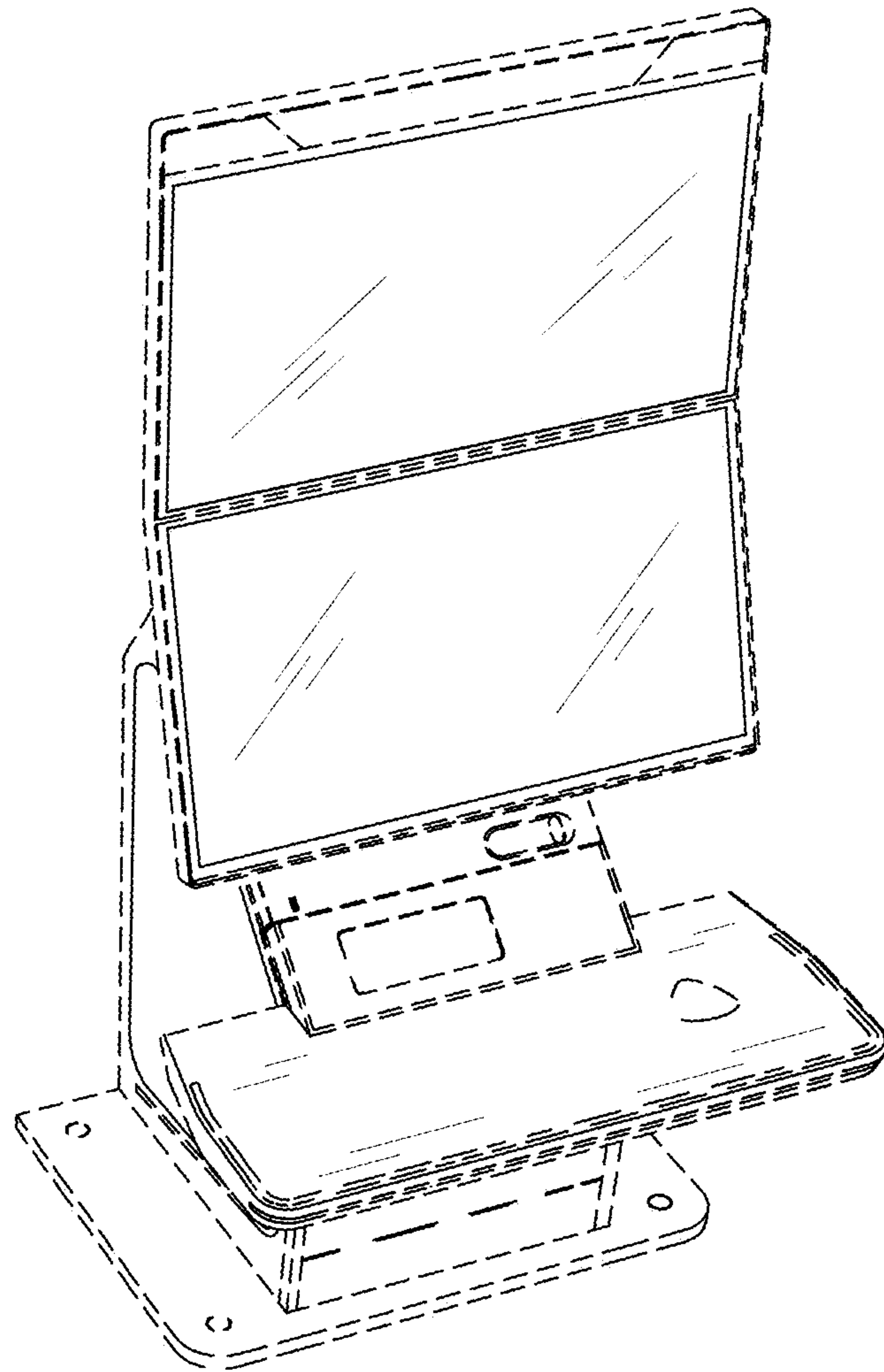

FIG. 17

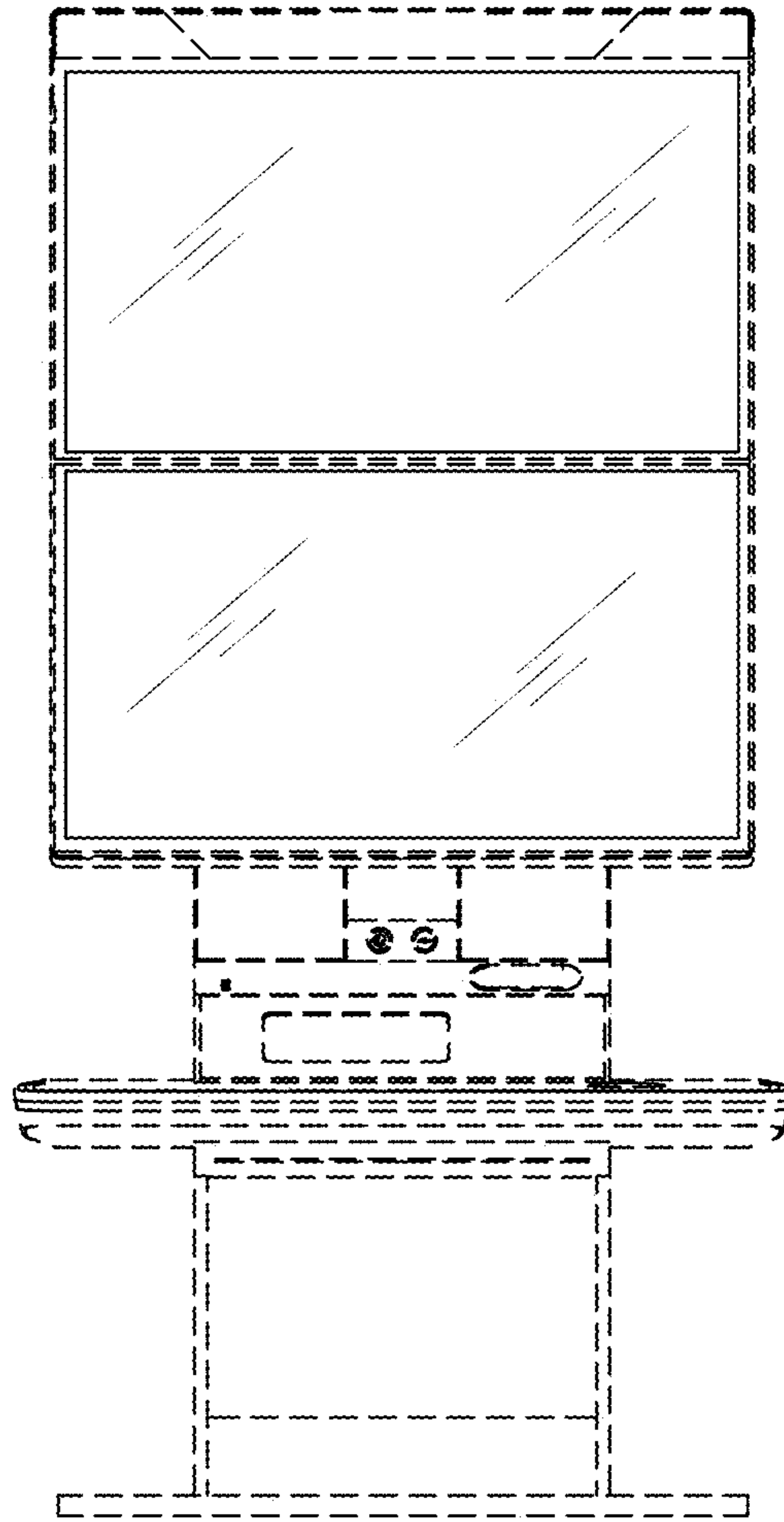

FIG. 18