



US00D907632S

(12) **United States Design Patent**  
**Shim**

(10) **Patent No.:** **US D907,632 S**  
(45) **Date of Patent:** **\*\* Jan. 12, 2021**

(54) **SOLID STATE DRIVE**

(71) Applicant: **SAMSUNG ELECTRONICS CO., LTD.**, Suwon-si (KR)

(72) Inventor: **Hyung Sup Shim**, Seoul (KR)

(73) Assignee: **SAMSUNG ELECTRONICS CO., LTD.**, Suwon-si (KR)

(\*\*) Term: **15 Years**

(21) Appl. No.: **29/692,200**

(22) Filed: **May 23, 2019**

(30) **Foreign Application Priority Data**

Nov. 23, 2018 (KR) ..... 30-2018-0054549

(51) **LOC (13) Cl.** ..... **14-02**

(52) **U.S. Cl.**  
USPC ..... **D14/348**; D14/363; D14/356

(58) **Field of Classification Search**  
USPC ..... D14/348-370, 383-385, 432, 433, 435, D14/436, 474, 480, 440, 498, 500, 502, D14/300-302, 314, 125, 135, 155, 496, D14/240-242, 299, 203.1, 203.3, 35, D14/435.1, 437; D13/103, 107, 108, 110, D13/119, 158, 162, 184, 199, 168; D3/276, 294, 373; D10/46, 49, 75, 104.1  
CPC ... G11B 33/027; G11B 33/122; G11B 33/124; G11B 33/00; G11B 33/02; G11B 33/022; G11B 33/025; H05K 5/00; H05K 5/0213; H05K 7/00; H05K 7/1427  
See application file for complete search history.

(56) **References Cited**

**U.S. PATENT DOCUMENTS**

D422,574 S \* 4/2000 Fujii ..... D14/368  
D451,919 S \* 12/2001 Abboud ..... D14/356  
D468,309 S \* 1/2003 Goldenberg ..... D14/368  
D578,158 S \* 10/2008 Hammad ..... D14/436

D586,793 S \* 2/2009 Lee ..... D14/240  
D620,006 S \* 7/2010 Bull ..... D14/356  
D625,719 S \* 10/2010 Carroll ..... D14/356  
D682,196 S \* 5/2013 Leung ..... D13/103  
D691,371 S \* 10/2013 Chen ..... D3/294  
D733,136 S \* 6/2015 Morgan ..... D14/365  
D742,822 S \* 11/2015 Ju ..... D13/108  
D762,168 S \* 7/2016 Sandoval ..... D13/107  
D789,359 S \* 6/2017 Zheng ..... D14/356  
D832,837 S \* 11/2018 Pennington, Jr. .... D14/348  
D847,812 S \* 5/2019 Shim ..... D14/356  
D856,324 S \* 8/2019 Shim ..... D14/348

(Continued)

**FOREIGN PATENT DOCUMENTS**

KR 30-0623898 S 12/2011  
KR 30-0683776 S 3/2013

**OTHER PUBLICATIONS**

Communication dated Aug. 12, 2019 issued by the Taiwan Intellectual Property Office in counterpart Taiwan Application No. 108302965.

*Primary Examiner* — Marie D. Fast Horse  
(74) *Attorney, Agent, or Firm* — Sughrue Mion, PLLC

(57) **CLAIM**

The ornamental design for a solid state drive, as shown and described.

**DESCRIPTION**

FIG. 1 is a perspective view showing my design.  
FIG. 2 is a front view thereof.  
FIG. 3 is a rear view thereof.  
FIG. 4 is a left side view thereof.  
FIG. 5 is a right side view thereof.  
FIG. 6 is a top view thereof; and,  
FIG. 7 is a bottom view thereof.  
The features of the solid state drive shown in broken lines form no part of the claimed design.

**1 Claim, 4 Drawing Sheets**

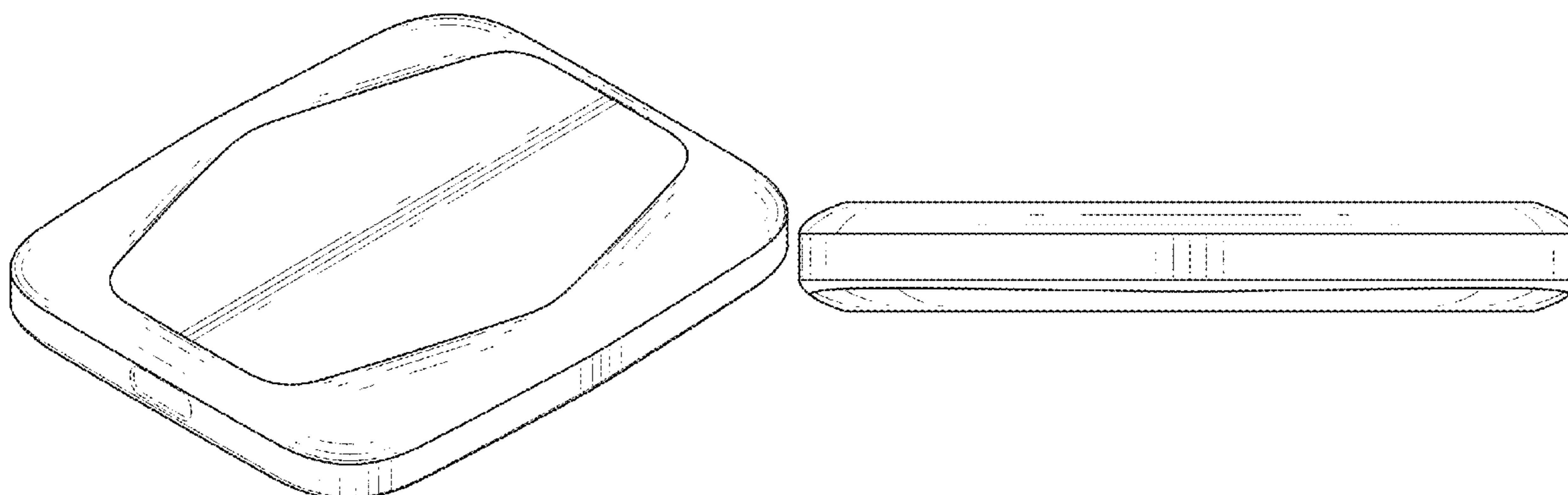

(56)

**References Cited**

U.S. PATENT DOCUMENTS

D856,326 S *	8/2019	Shim .....	D14/356
D860,935 S *	9/2019	Rosen .....	D13/108
D879,774 S *	3/2020	Pennington, Jr. ....	D14/348
D885,329 S *	5/2020	Gan .....	D13/107
D886,101 S *	6/2020	Pai .....	D14/357

\* cited by examiner

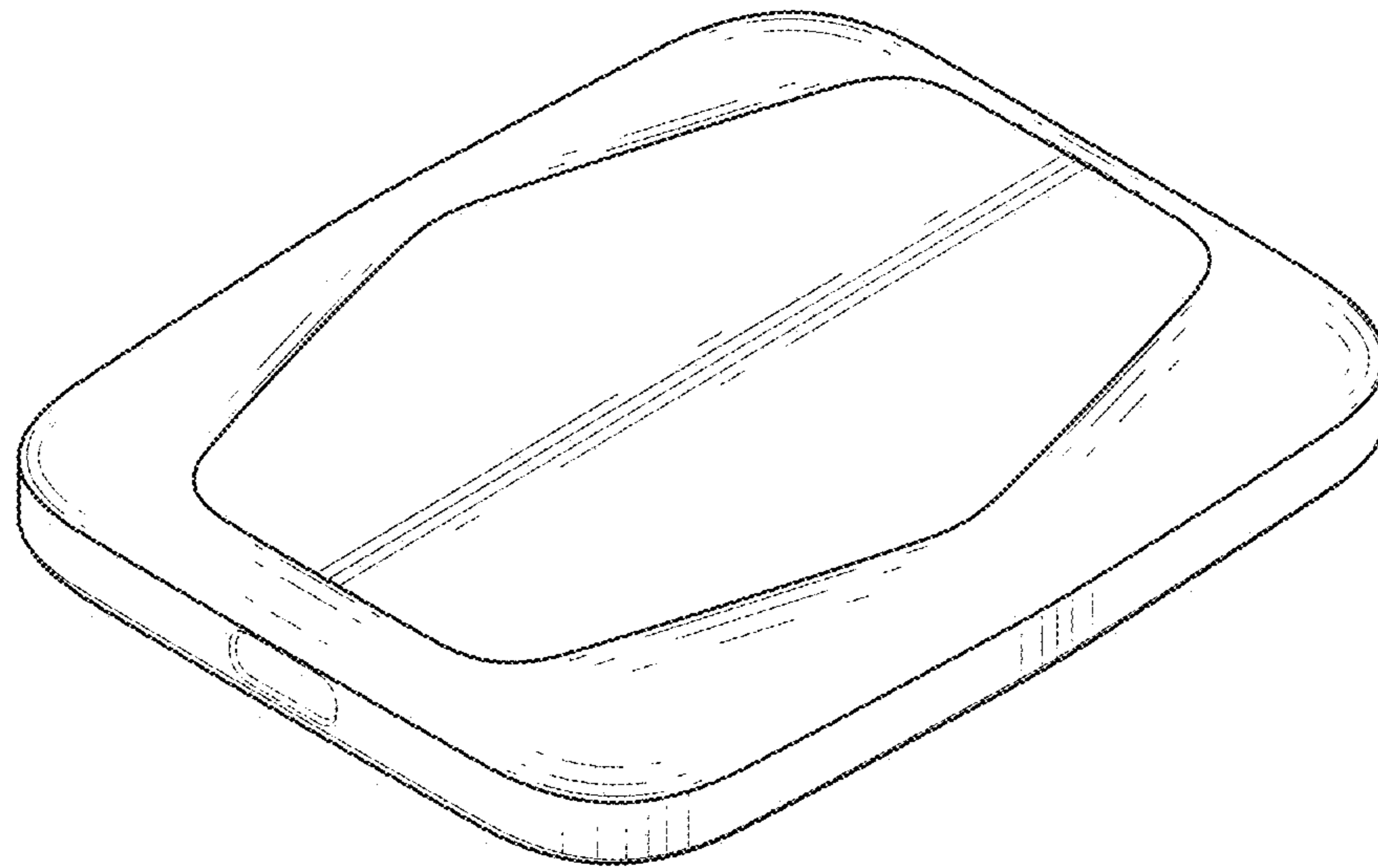

FIG. 1

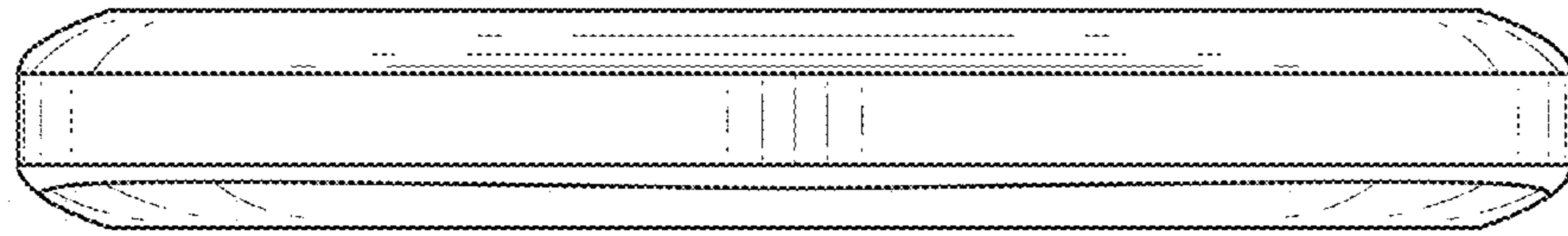

FIG. 2

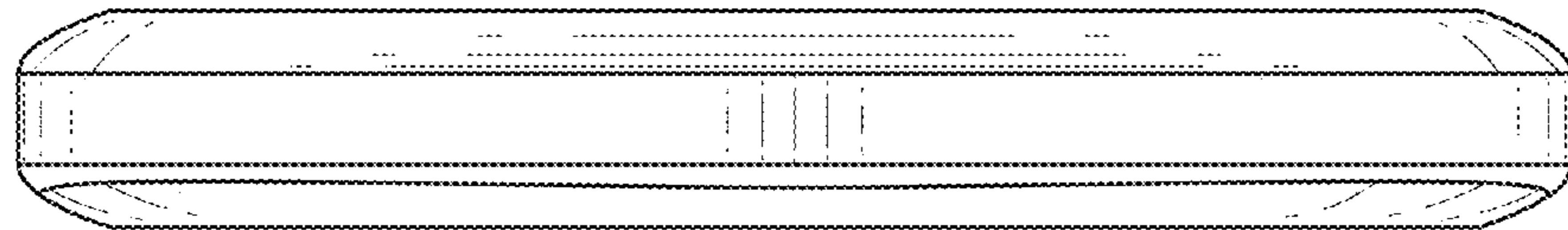

FIG. 3

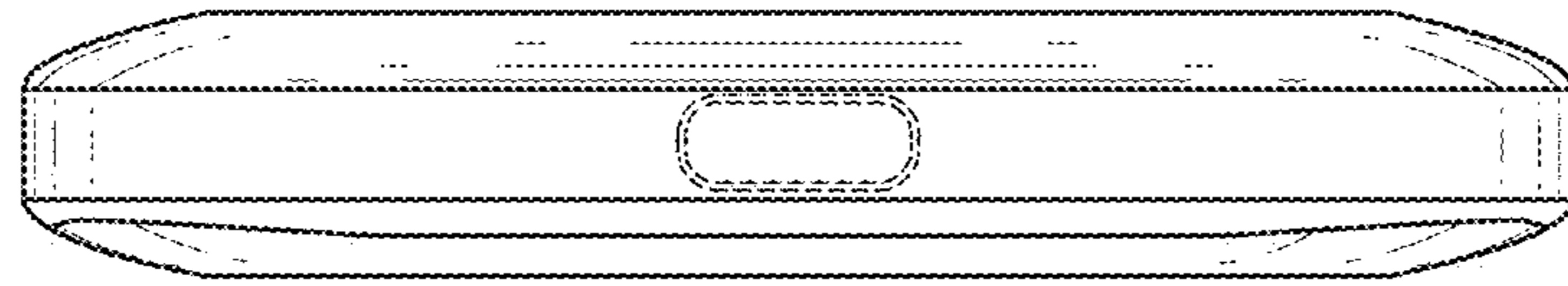

FIG. 4

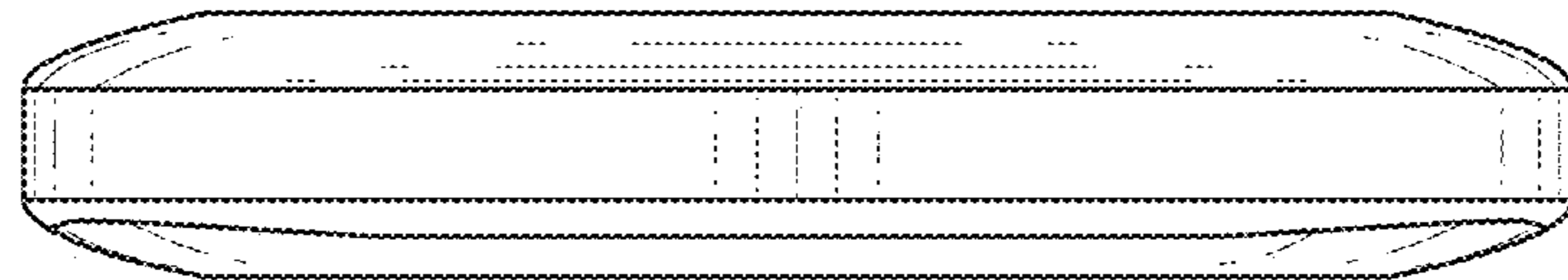

FIG. 5

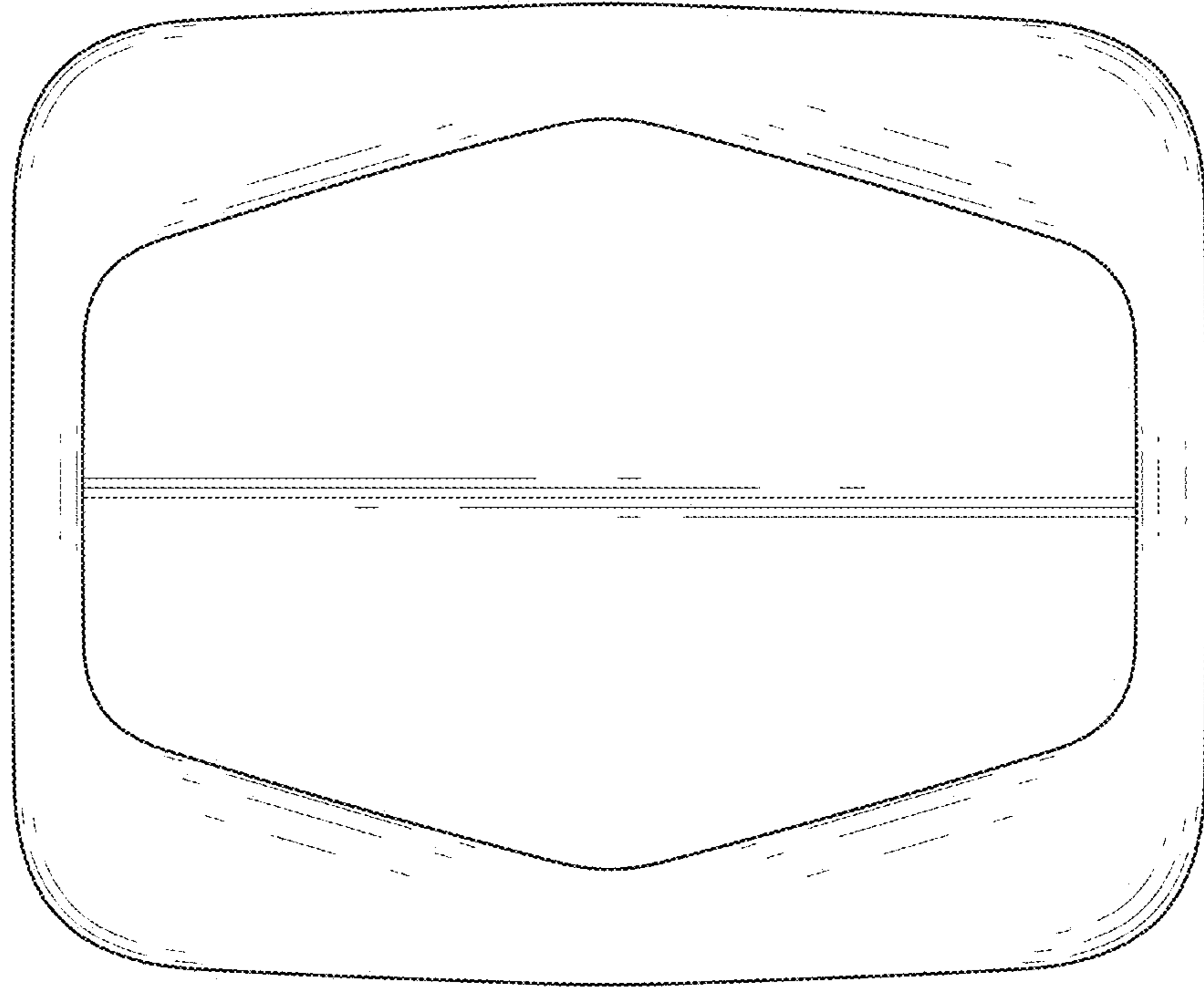

FIG. 6

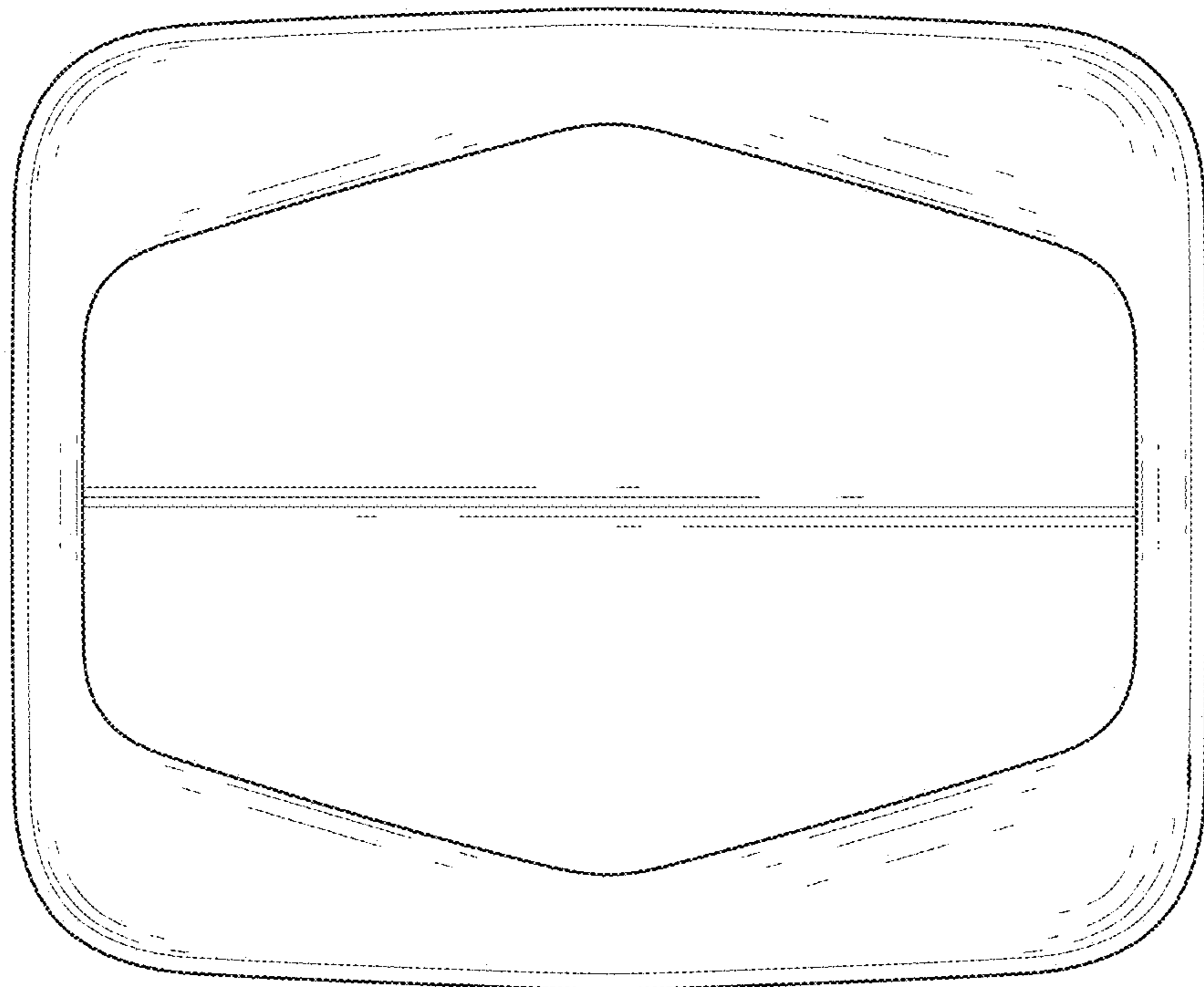

FIG. 7