



US00D907622S

(12) **United States Design Patent** (10) **Patent No.:** **US D907,622 S**
Kim (45) **Date of Patent:** **** *Jan. 12, 2021**

(54) **CASE FOR ELECTRONIC COMMUNICATIONS DEVICE**

(71) Applicant: **SPIGEN KOREA CO., LTD.**, Seoul (KR)

(72) Inventor: **Seung Joo Kim**, Seoul (KR)

(73) Assignee: **SPIGEN KOREA CO., LTD.**, Seoul (KR)

(*) Notice: This patent is subject to a terminal disclaimer.

(**) Term: **15 Years**

(21) Appl. No.: **29/689,628**

(22) Filed: **Apr. 30, 2019**

(30) **Foreign Application Priority Data**

Oct. 31, 2018 (EM) 005813821-0003

(51) **LOC (13) Cl.** **14-03**

(52) **U.S. Cl.**
USPC **D14/250**

(58) **Field of Classification Search**
USPC D14/250, 203.3–203.7, 439, 238.1, 440, D14/251–253, 447, 217, 240, 248; D3/201, 218, 247, 269, 273, 301, 303; D13/103, 119, 107–108
CPC H04B 1/3888; H04M 1/0283; H04M 1/0202; A45C 1/06; A45C 11/00; A45C 13/02; A45C 2011/002; A45F 2005/026; A45F 2200/0525; A45F 2200/0516
See application file for complete search history.

(56) **References Cited**

U.S. PATENT DOCUMENTS

D357,918 S * 5/1995 Doria D14/218
D575,056 S 8/2008 Tan

(Continued)

OTHER PUBLICATIONS

“Caseology Vault for Apple iPhone 8 Case (2017) / for iPhone 7 Case (2016)—Rugged & Flexible—Matte Black”, <https://www.amazon.com/dp/B01JSZOJ7M>, Earliest review date of Sep. 10, 2016, Downloaded on Jan. 16, 2020.

(Continued)

Primary Examiner — Carla J Wright

(74) *Attorney, Agent, or Firm* — Heedong Chae; Lucem, PC

(57) **CLAIM**

The ornamental design for a case for electronic communications device, as shown and described.

DESCRIPTION

FIG. 1 is a front perspective view of a case for electronic communications device showing my new design; FIG. 2 is a rear perspective view thereof; FIG. 3 is a front elevational view thereof; FIG. 4 is a rear elevational view thereof; FIG. 5 is a left side elevational view thereof; FIG. 6 is a right side elevational view thereof; FIG. 7 is a top plan view thereof; FIG. 8 is a bottom plan view thereof; FIG. 9 is an enlarged detail view of the upper encircled portion of FIG. 2; FIG. 10 is an enlarged detail view of the lower encircled portion of FIG. 2; and, FIG. 11 is an enlarged detail view of the encircled portion of FIG. 5.

The dot-dash broken line circles in FIGS. 2, 5, 9, 10, and 11 delineate portions of the case that are part of the claimed design and shown on an enlarged scale in FIGS. 9, 10, and 11. The dashed broken lines, regions bounded by dashed broken lines, and the interior of the case shown in FIGS. 1 and 3 form no part of the claimed design.

1 Claim, 11 Drawing Sheets

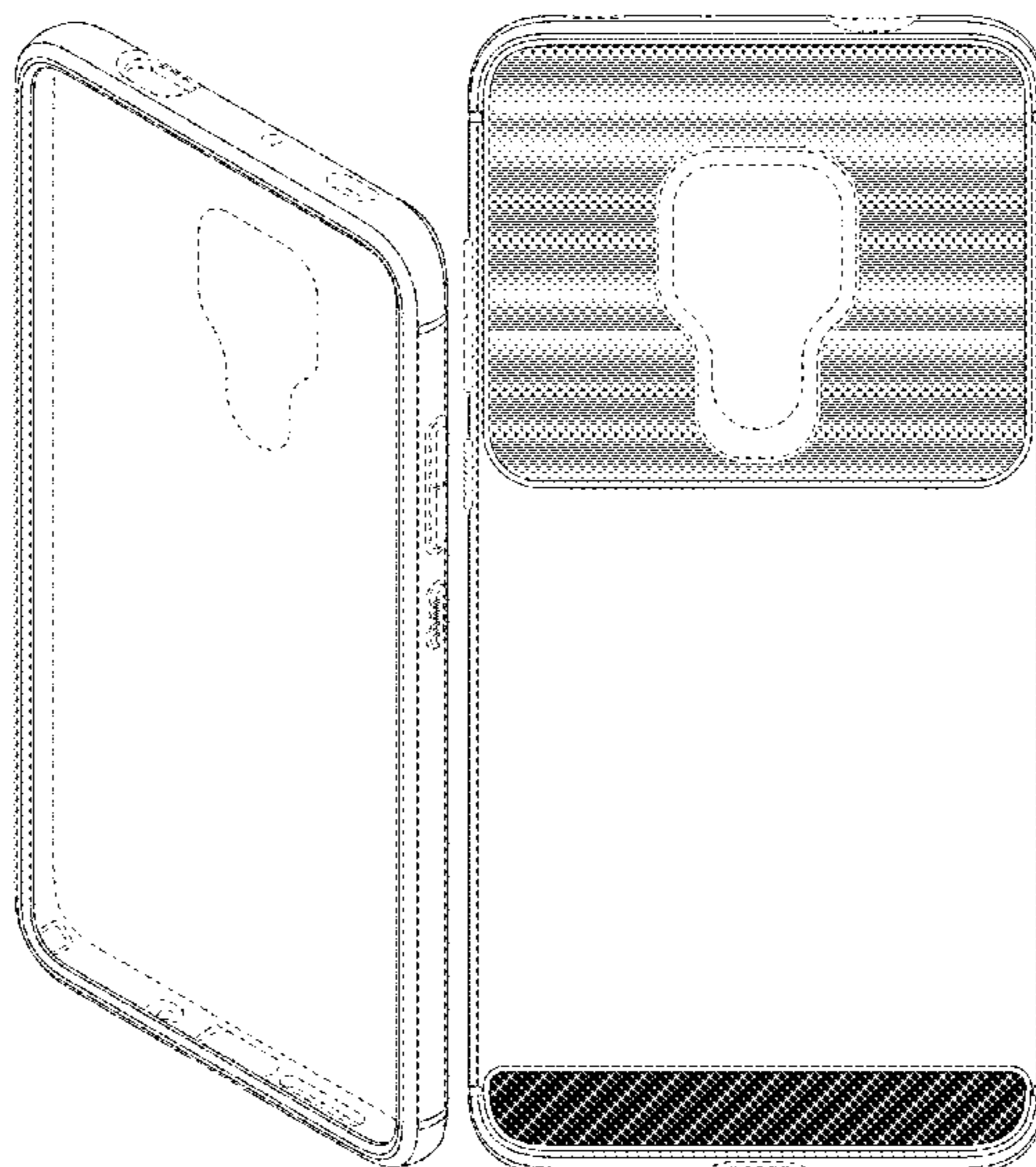

(56)

References Cited

U.S. PATENT DOCUMENTS

D606,305 S *	12/2009	Lee	D3/269	D734,747 S	7/2015	Seo et al.	
D609,672 S	2/2010	Lee		9,143,181 B1	9/2015	Jia	
D619,361 S	7/2010	Andre et al.		D741,845 S	10/2015	Kim	
D632,685 S	2/2011	Richardson		D743,389 S	11/2015	Akana	
D643,029 S	8/2011	Feng		D746,273 S	12/2015	Herbst	
D646,265 S	10/2011	Fathollahi		D746,274 S	12/2015	Herbst	
D648,332 S	11/2011	Kim et al.		D746,275 S	12/2015	Mohammad	
D650,371 S	12/2011	Wibby et al.		9,223,346 B2	12/2015	Wilson	
D654,485 S	2/2012	Chang et al.		D748,614 S	2/2016	Ju	
D654,491 S	2/2012	Melanson et al.		D749,068 S	2/2016	Zaborski et al.	
D655,281 S	3/2012	Turocy		D749,535 S	2/2016	Joung et al.	
D655,287 S	3/2012	de Jong et al.		D749,555 S	2/2016	Poon et al.	
D657,782 S	4/2012	Biller		D749,557 S	2/2016	Feng	
D663,297 S	7/2012	de Jong et al.		9,247,795 B2	2/2016	Kim	
D664,133 S	7/2012	Zheng		D751,058 S	3/2016	Cocchia	
D666,824 S *	9/2012	Phillips	D3/303	9,288,295 B2	3/2016	Ivanovski	
D669,071 S	10/2012	Akana et al.		9,293,808 B1	3/2016	Roberts	
D671,930 S	12/2012	Akana et al.		D753,099 S	4/2016	Kim	
D672,739 S *	12/2012	Sin	D14/138 G	D756,340 S	5/2016	Babichenko	
D673,547 S	1/2013	Melanson		D756,343 S	5/2016	Wall	
D673,940 S *	1/2013	Chang	D14/250	D756,909 S	5/2016	Gupta	
D674,369 S	1/2013	JaeWoong		D756,910 S	5/2016	Gupta et al.	
D676,036 S	2/2013	Chang		D756,911 S	5/2016	Gupta et al.	
D676,844 S	2/2013	Weller		D757,699 S	5/2016	Lee	
D677,249 S	3/2013	Li et al.		D761,239 S	7/2016	Kim	
D678,328 S	3/2013	Lee et al.		D762,205 S	7/2016	Dang	
D678,907 S	3/2013	Lee		D763,241 S	8/2016	Kim	
D679,271 S	4/2013	Liu		D763,242 S	8/2016	Kim	
D679,685 S	4/2013	Cox		D763,837 S	8/2016	Choe et al.	
D679,690 S	4/2013	Fahrendorff et al.		D763,841 S	8/2016	Kim	
D679,692 S	4/2013	Fahrendorff et al.		D763,842 S	8/2016	Chang et al.	
D679,697 S	4/2013	Murchison		D764,476 S	8/2016	Gleason, III	
D679,698 S	4/2013	Murchison		D765,067 S	8/2016	Choe et al.	
D681,022 S	4/2013	Chang		D765,627 S	9/2016	Watt	
D681,615 S	5/2013	Fathollahi		D765,635 S	9/2016	Chang et al.	
D681,617 S	5/2013	Weller et al.		D765,638 S	9/2016	Gaylord et al.	
D683,340 S	5/2013	Chang et al.		D765,640 S	9/2016	Bulkley et al.	
D683,723 S	6/2013	Murchison		D765,641 S	9/2016	Bulkley et al.	
D684,568 S	6/2013	Fitzgerald		D765,642 S	9/2016	Bulkley	
D684,960 S	6/2013	Murchison		D765,644 S	9/2016	Witter	
D685,357 S *	7/2013	Rekuc	D14/250	D765,645 S	9/2016	Kim	
D685,740 S *	7/2013	Moore	D13/119	D767,485 S	9/2016	To et al.	
D685,776 S	7/2013	Bau		D767,553 S	9/2016	Fathollahi	
D687,425 S	8/2013	Fahrendorff et al.		D771,607 S	11/2016	Kim	
D691,122 S	10/2013	Bau		D771,608 S	11/2016	Kim	
D691,124 S	10/2013	Yang		D771,611 S	11/2016	Chang et al.	
D691,601 S	10/2013	Murchison et al.		D772,209 S	11/2016	Kim	
D692,418 S	10/2013	Fahrendorff et al.		D772,854 S	11/2016	Igarashi	
D697,905 S	1/2014	Chang		D772,858 S	11/2016	Hu	
D698,767 S	2/2014	Son		9,480,318 B2	11/2016	Stiehl	
D700,174 S	2/2014	Li		9,480,319 B2	11/2016	Dining et al.	
D703,652 S	4/2014	Melanson		D774,498 S	12/2016	Tao	
D704,688 S	5/2014	Reivo		D775,112 S	12/2016	Hemesath	
D706,254 S	6/2014	Chang		D775,113 S *	12/2016	Lim	D14/250
D712,386 S	9/2014	Lu		D775,614 S	1/2017	Kim et al.	
D713,834 S *	9/2014	Almstrom	D14/250	D776,647 S	1/2017	Kim	
D714,273 S	9/2014	Kim et al.		D777,157 S	1/2017	Kim	
D714,274 S	9/2014	Jung		D777,160 S	1/2017	Kim	
D714,276 S	9/2014	Hu		D777,717 S	1/2017	Kim	
D716,281 S	10/2014	Melanson et al.		D779,470 S	2/2017	Kim	
D716,282 S	10/2014	Melanson et al.		D781,835 S	3/2017	Kim et al.	
D716,783 S *	11/2014	Loncar	D14/250	D781,837 S	3/2017	Kim	
D717,286 S	11/2014	Veldkamp		D781,838 S *	3/2017	Kim	D14/250
D717,774 S	11/2014	Fathollahi		D781,840 S	3/2017	Kim et al.	
D717,778 S	11/2014	Zermeno		D782,453 S *	3/2017	Kim	D14/248
D718,292 S	11/2014	Hemesath		D782,457 S	3/2017	Park et al.	
D721,065 S	1/2015	Yoon		D783,602 S *	4/2017	Akana	D14/341
D721,067 S	1/2015	Su		D784,309 S	4/2017	Lee et al.	
D721,070 S	1/2015	Pickett		9,628,133 B2	4/2017	Kim	
D727,883 S	4/2015	Brand et al.		D785,615 S	5/2017	Kim et al.	
D727,886 S	4/2015	Bertrand et al.		D786,849 S	5/2017	Park et al.	
9,004,275 B2	4/2015	Lee		D788,093 S	5/2017	Lee et al.	
D731,472 S *	6/2015	Lee	D14/250	9,661,116 B1	5/2017	Chung	
D731,481 S	6/2015	Akana et al.		D792,394 S	7/2017	Lee et al.	
D732,012 S	6/2015	Tsai		D795,237 S	8/2017	Jung et al.	
				D797,715 S	9/2017	Kim	
				D798,286 S	9/2017	Roberts et al.	
				D801,325 S *	10/2017	Kim	D14/250
				D810,064 S	2/2018	Kim et al.	

(56)

References Cited

U.S. PATENT DOCUMENTS

D816,073	S *	4/2018	Kim	D14/250
D823,297	S *	7/2018	Kim	D14/250
D832,833	S *	11/2018	Kim	D14/250
D836,095	S *	12/2018	Kim	D14/250
D840,992	S	2/2019	Kim		
D844,555	S *	4/2019	McLean	D13/103
D853,371	S *	7/2019	Wei	D14/250
D853,372	S *	7/2019	Kim	D14/250
2011/0050606	A1	3/2011	Zhang		
2012/0217174	A1 *	8/2012	Ting	G06F 1/1628 206/45.2
2014/0357330	A1	12/2014	Lin		
2015/0053583	A1	2/2015	McCormick		
2015/0189963	A1	7/2015	Lai		
2016/0094263	A1 *	3/2016	Fathollahi	H04B 1/3888 455/575.8
2016/0101902	A1	4/2016	Kim		
2016/0204817	A1	7/2016	Kim		
2016/0285301	A1	9/2016	Kim		
2017/0123217	A1	5/2017	Dukerschein		

OTHER PUBLICATIONS

“The best iPhone 7 & 7 Plus cases available now”, <https://9to5mac.com/2016/09/07/best-iphone-7-7-plus-cases-accessories-available-now/>, Earliest review date of Sep. 17, 2016, Downloaded on Mar. 18, 2020.

“Caseology Vault for Google Pixel Case (2016)—Rugged & Flexible—Black”, <https://www.amazon.com/dp/B01MEDIMGS>, Earliest review date of Nov. 10, 2016, Downloaded on Jan. 16, 2020.

“Caseology Vault for Apple iPhone 7 Plus Case (2016)—Rugged Matte Finish—Black”, <https://www.amazon.com/dp/B01N2OCQV4>, Earliest review date of Dec. 16 2016, Downloaded on Jan. 16, 2020.

“Caseology Vault for LG G6 Case (2017)—Rugged Matte Finish—Black”, <https://www.amazon.com/dp/B06W52JLH>, Earliest review date of Mar. 28, 2017, Downloaded on Jan. 16, 2020.

“Caseology Nero Tough for iPhone 8 Plus Case (2017) / iPhone 7 Plus Case (2016)—360 Protection—Black”, <https://www.amazon.com/dp/B07534JMM2>, Earliest review date of Aug. 23, 2017, Downloaded on Nov. 19, 2019.

“Spigen Rugged Armor Galaxy S6 Case with Resilient Shock Absorption and Carbon Fiber Design for Galaxy S6 2015—Black”, <https://www.amazon.com/dp/B00T6P05ZK>, Earliest review date of Mar. 10, 2015, Downloaded on Jul. 17, 2018.

“Spigen Rugged Armor Galaxy S6 Edge Case with Flexible and Durable Shock Absorption with Carbon Fiber Design for Samsung Galaxy S6 Edge (2015)—Black”, <https://www.amazon.com/dp/B00SVCITW0>, Earliest review date of Mar. 13, 2015, Downloaded on Jul. 17, 2018.

“Spigen Rugged Armor Galaxy Note 5 Case with Resilient Shock Absorption and Carbon Fiber Design for Galaxy Note 5 2015—Black”, <https://www.amazon.com/dp/B010MWFUBY>, Earliest review date of Aug. 23, 2015, Downloaded on Jul. 17, 2018.

“Spigen Rugged Armor iPhone 6S Case with Resilient Shock Absorption and Carbon Fiber Design for iPhone 6S/ iPhone 6—Black”, <https://www.amazon.com/dp/B010MVJM5K>, Earliest review date of Sep. 3, 2015, Downloaded on Jul. 17, 2018.

“Spigen Rugged Armor iPhone 6S Plus Case with Resilient Shock Absorption and Carbon Fiber Design for iPhone 6S Plus 2015—Black”, <https://www.amazon.com/dp/B010MVR76Q>, Earliest review date of Sep. 7, 2015, Downloaded on Jul. 17, 2018.

“Spigen Tough Armor Tech iPhone 6S Case with Extreme Shock and Drop Protection for Apple iPhone 6 / 6S—Gunmetal”, <https://www.amazon.com/Spigen-Tough-iPhone-Extreme-Protection/dp/B013TKNSIS>, Earliest review date 3f Oct. 3, 2015, Downloaded on Jan. 15, 2019.

“Spigen Rugged Armor Samsung Galaxy S7 Case with Resilient Shock Absorption and Carbon Fiber Design for Samsung Galaxy S7 2016—Black”, <https://www.amazon.com/Spigen-Rugged-Designed->

Samsung-Galaxy/dp/B01A7ICWTQ, Earliest review date of Feb. 25, 2016, Downloaded on Jul. 17, 2018.

“Spigen Rugged Armor Galaxy S7 Edge Case with Flexible and Durable Shock Absorption with Carbon Fiber Design for Samsung Galaxy S7 Edge (2016)—Black”, <https://www.amazon.com/Spigen-Rugged-Designed-Samsung-Galaxy/dp/B01A7IDHOU>, Earliest review date of Feb. 28, 2016, Downloaded on Jul. 17, 2018.

“Spigen Rugged Armor Galaxy A5 Case with Resilient Shock Absorption and Carbon Fiber Design for Galaxy A5 Black”, <https://www.amazon.com/Spigen-Rugged-Designed-Samsung-Galaxy/dp/B018J07A46>, Earliest review date of Mar. 18, 2016, Downloaded on Jul. 17, 2018.

“Spigen Rugged Armor iPhone SE Case with Resilient Shock Absorption and Carbon Fiber Design for iPhone SE 2016—Black”, <https://www.amazon.com/Spigen-Rugged-iPhone-Resilient-Absorption/dp/B01BEDNUDK>, Earliest review date of Apr. 10, 2016, Downloaded on Jan. 15, 2019.

“Spigen Rugged Armor Honor 5X Case with Resilient Shock Absorption and Carbon Fiber Design for Huawei Honor 5X—Black”, <https://www.amazon.com/Spigen-Rugged-Resilient-Absorption-Carbon/dp/B01DJHXXD2>, Earliest review date of May 1, 2016, Downloaded on Jan. 15, 2019.

“Spigen Rugged Armor HTC 10 Case with Resilient Shock Absorption and Carbon Fiber Design for HTC 10 2016—Black”, <https://www.amazon.com/dp/B01DAN1T4E>, Earliest review date of May 4, 2016, Downloaded on Jul. 18, 2018.

“Spigen Rugged Armor OnePlus 3 Case/OnePlus 3T Case with Resilient Shock Absorption and Carbon Fiber Design for OnePlus 3 2016—Black”, <https://www.amazon.com/dp/B01H3PEWDK>, Earliest review date of Jul. 28, 2016, Downloaded on Jul. 17, 2018.

“Spigen Rugged Armor iPhone 8 Case / iPhone 7 Case with Resilient Shock Absorption and Carbon Fiber Design for Apple iPhone 8 (2017) / iPhone 7 (2016)—Black”, <https://www.amazon.co.uk/Spigen-Rugged-iPhone-Resilient-Absorption/dp/B01GIVX7TA>, Earliest review date of Aug. 2, 2016, downloaded on Oct. 24, 2018.

“Spigen Rugged Armor iPhone 8 Plus/iPhone 7 Plus Case with Resilient Shock Absorption and Carbon Fiber Design for Apple iPhone 8 Plus (2017)/iPhone 7 Plus (2016)—Black”, <https://www.amazon.com/dp/B01GIWGAAC>, Earliest review date of Sep. 2, 2016, Downloaded on Jul. 17, 2018.

“Spigen Rugged Armor Huawei P9 Lite Case with Resilient Shock Absorption and Carbon Fiber Design for Huawei P9 Lite—Black”, <https://www.amazon.com/B01DL0DJGM>, Earliest review date of Sep. 6, 2016, Downloaded on Jul. 18, 2018.

“Spigen Rugged Armor iPhone 8 Case/iPhone 7 Case with Resilient Shock Absorption and Carbon Fiber Design for Apple iPhone 8 (2017)/iPhone 7 (2016)—Black”, <https://www.amazon.com/dp/B01GIVX7TA>, Earliest review date of Sep. 11, 2016, Downloaded on Jul. 17, 2018.

“Spigen Rugged Armor Google Pixel XL Case with Resilient Shock Absorption and Carbon Fiber Design for Google Pixel XL 2016—Black”, <https://www.amazon.com/dp/B01M1EEXWJ>, Earliest review date of Oct. 2, 2016, Downloaded on Jul. 17, 2018.

“Spigen Rugged Armor LG V20 Case with Resilient Shock Absorption and Carbon Fiber Design for LG V20 2016—Black”, <https://www.amazon.com/dp/B01M0HW9P4>, Earliest review date of Oct. 19, 2016, Downloaded on Jul. 18, 2018.

“Spigen Rugged Armor Honor 8 Case with Resilient Shock Absorption for Huawei Honor 8 2016—Black”, <https://www.amazon.com/dp/B01LXTROW1>, Earliest review date of Oct. 20, 2016, Downloaded on Jul. 18, 2018.

“Spigen Rugged Armor Moto Z Droid Case with Resilient Shock Absorption and Carbon Fiber Design for Moto Z Droid 2016—Black”, <https://www.amazon.com/dp/B01HCACIMBQ>, Earliest review date of Dec. 9, 2016, Downloaded on Jul. 17, 2018.

“Spigen Rugged Armor Galaxy A3 2016 Case with Resilient Shock Absorption and Carbon Fiber Design for Galaxy A3 2016—Black”, <https://www.amazon.com/Spigen-Rugged-Armor-Samsung-Galaxy/dp/B01HFMYLIC>, Earliest review date of Dec. 18, 2016, Downloaded on Jul. 17, 2018.

“Spigen Rugged Armor ZenFone 3 Max Case (ZC520TL) with Resilient Shock Absorption and Carbon Fiber Design for ASUS

(56)

References Cited

OTHER PUBLICATIONS

ZenFone 3 Max (ZC520TL)—Black”, <https://www.amazon.com/dp/B01MSDJQ7C>, Earliest review date of Mar. 3, 2017, Downloaded on Jul. 18, 2018.

“Spigen Rugged Armor Extra Designed for LG G6 Case (2017) / Designed for LG G6 Plus (2017)—Black”, <https://www.amazon.com/Spigen-Rugged-Resilient-Absorption-Carbon/dp/B01N6T9PHS>, Earliest review date of Mar. 28, 2017, Downloaded on Jan. 9, 2020.

“Spigen Rugged Armor LG G6 Case/G6 Plus Case with Resilient Shock Absorption and Carbon Fiber Design for LG 36/G6 Plus (2017)—Black”, <https://www.amazon.com/dp/B01MUCZILA>, Earliest review date of Mar. 30, 2017, Downloaded on Jul. 18, 2018.

“Spigen Rugged Armor Galaxy S8 Plus Case with Resilient Shock Absorption and Carbon Fiber Design for Galaxy S8 Plus (2017)—Black”, <https://www.amazon.com/Spigen-Rugged-Designed-Samsung-Galaxy/dp/B06XNW4ZVJ>, Earliest review date of Apr. 3, 2017, Downloaded on Jul. 17, 2018.

“Spigen Rugged Armor Galaxy S8 Case with Resilient Shock Absorption and Carbon Fiber Design for Samsung Galaxy S8 (2017)—Black”, <https://www.amazon.com/Spigen-Rugged-Designed-Samsung-Galaxy/dp/B06XNNJ4KM>, Earliest review date of Apr. 7, 2017, Downloaded on Jul. 17, 2018.

Spigen, “Spigen Rugged Armor Extra”, <https://www.youtube.com/watch?v=ILUEjn1P2hk>, Published May 26, 2017, downloaded on Jan. 9, 2020.

“Spigen Rugged Armor Huawei P10 Plus Case with Resilient Shock Absorption and Carbon Fiber Design for Huawei P10 Plus(2017)—Rugged Armor”, <https://www.amazon.com/dp/B06XFZW779>, Earliest review date of May 26, 2017, Downloaded on Jul. 18, 2018.

“Spigen Rugged Armor Galaxy J7 2017 Case, J7 Prime, J7 2017(AT &T), J7 Sky Pro, J7 Perx case with Resilient Shock Absorption and Carbon Fiber Design for Samsung Galaxy J7 V 2017—Black”, <https://www.amazon.com/Spigen-Rugged-Resilient-Absorption-Samsung/dp/B06WRRF36B>, Earliest review date of May 31, 2017, Downloaded on Jan. 15, 2019.

“Spigen Rugged Armor Huawei P10 Lite Case with Resilient Shock Absorption and Carbon Fiber Design for Huawei P10 Lite (2017)—Black”, <https://www.amazon.com/dp/B06XC�Q3S4>, Earliest review date of Jun. 7, 2017, Downloaded on Jul. 18, 2018.

“Spigen Rugged Armor Huawei P10 Case with Resilient Shock Absorption and Carbon Fiber Design for Huawei P10 (2017)—Black”, <https://www.amazon.com/dp/B06XCTQRIW>, Earliest review date of Jun. 8, 2017, Downloaded on Jul. 18, 2018.

“Spigen Rugged Armor HTC U11 Case with Resilient Shock Absorption and Carbon Fiber Design for HTC U 11 (2017)—Black”, <https://www.amazon.com/dp/B07234FLGX>, Earliest review date of Jun. 17, 2017, Downloaded on Jul. 18, 2018.

“Spigen Rugged Armor Huawei P8 Lite 2017 Case with Resilient Shock Absorption and Carbon Fiber Design for Huawei P8 Lite (2017)/nova lite/P9 lite 2017/Honor 8 lite—Black”, <https://www.amazon.com/dp/B06XFVXMLN>, Earliest review date of Jun. 24, 2017, Downloaded on Jul. 18, 2018.

“Spigen Rugged Armor Extra Galaxy Temp Case with Resilient Shock Absorption and Carbon Fiber Design for Galaxy Temp (2017)—Black”, <https://www.amazon.com/Spigen-Rugged-Galaxy-Resilient-Absorption/dp/B01MTEQVNB>, Earliest review date of Jul. 6, 2017, downloaded on Jan. 9, 2020.

“Spigen Rugged Armor Sony Xperia XZ Premium Case with Resilient Shock Absorption and Carbon Fiber Design for Sony Xperia XZ Premium (2017)—Black”, <https://www.amazon.com/dp/B072PRXPQC>, Earliest review date of Jul. 14, 2017, Downloaded on Jul. 18, 2018.

“Spigen Rugged Armor OnePlus 5 Case with Resilient Shock Absorption and Carbon Fiber Design for OnePlus 5 (2017)—Black”, <https://www.amazon.com/dp/B06XG19W3G>, Earliest review date of Jul. 25, 2017, Downloaded on Jul. 17, 2018.

“Spigen Rugged Armor Moto Z2 Play Case with Resilient Shock Absorption and Carbon Fiber Design for Moto Z2 Play Black”,

<https://www.amazon.com/dp/B071WR4H9V>, Earliest review date of Jul. 27, 2017, Downloaded on Jul. 17, 2018.

“Spigen Rugged Armor Galaxy Note 8 Case with Resilient Shock Absorption and Carbon Fiber Design for Galaxy Note 8 (2017)—Matte Black”, <https://www.amazon.com/Spigen-Rugged-Galaxy-Resilient-Absorption/dp/B073RWJ6Z7>, Earliest review date of Aug. 26, 2017, Downloaded on Jan. 15, 2019.

“Spigen Rugged Armor Galaxy Note 8 Case with Resilient Shock Absorption and Carbon Fiber Design for Galaxy Note 8 (2017)—Matte Black”, <https://www.amazon.com/Spigen-Rugged-Designed-Samsung-Galaxy/dp/B073RWJ6Z7>, Earliest review date of Aug. 26, 2017, Downloaded on Jul. 17, 2018.

“Spigen Rugged Armor Moto E4 Case with Resilient Shock Absorption and Carbon Fiber Design for Moto E4 (2017)—Black”, <https://www.amazon.com/Spigen-Rugged-Armor-Designed-Motorola/dp/B073RVC6YY>, Earliest review date of Sep. 5, 2017, Downloaded on Jul. 17, 2018.

“Spigen Rugged Armor Extra Designed for Apple iPhone 7 Case (2016)—Black”, <https://www.amazon.com/Spigen-Rugged-iPhone-Resilient-Absorption/dp/B06XC8WL7P>, Earliest review date of Sep. 7, 2017, downloaded on Jan. 9, 2020.

“Spigen Rugged Armor Moto Z2 Force Case with Resilient Shock Absorption and Carbon Fiber Design for Moto Z2 Force (2017)—Black”, <https://www.amazon.com/Spigen-Rugged-Resilient-Absorption-Carbon/dp/B074BCC6K7>, Earliest review date of Sep. 23, 2017, downloaded on Jul. 17, 2018.

“Spigen Rugged Armor Designed for Apple iPhone Xs Case (2018)/ Designed for Apple iPhone X Case (2017)—Matte Black”, <https://www.amazon.com/Spigen-Rugged-Armor-Designed-iPhone/dp/B074CNF6YW>, Earliest review date of Sep. 28, 2017, Downloaded on Jan. 15, 2019.

“Spigen Rugged Armor iPhone X Case with Resilient Shock Absorption and Carbon Fiber Design for Apple iPhone X (2017)—Matte Black”, <https://www.amazon.com/dp/B074CNF6YW>, Earliest review date of Sep. 28, 2017, Downloaded on Jul. 17, 2018.

“Spigen Rugged Armor LG V30 with Resilient Shock Absorption and Carbon Fiber Design for LG V30 (2017)—Black”, <https://www.amazon.com/dp/B071JV1L9Z>, Earliest review date of Oct. 5, 2017, Downloaded on Jul. 17, 2018.

“Spigen Rugged Armor Google Pixel 2 Case with Resilient Shock Absorption and Carbon Fiber Design for Google Pixel 2 (2017)—Black”, <https://www.amazon.com/Spigen-Rugged-Google-Resilient-Absorption/dp/B07471C38C>, Earliest review date of Oct. 10, 2017, Downloaded on Jan. 5, 2019.

“Spigen Rugged Armor Google Pixel 2 Case with Resilient Shock Absorption and Carbon Fiber Design for Google Pixel 2 (2017)—Black”, <https://www.amazon.com/dp/B07471C38C>, Earliest review date of Oct. 10, 2017, Downloaded on Jul. 17, 2018.

“Spigen Rugged Armor Google Pixel 2 XL Case with Resilient Shock Absorption and Carbon Fiber Design for Google Pixel 2 XL (2017)—Black”, <https://www.amazon.com/Spigen-Rugged-Google-Resilient-Absorption/dp/B07475TXJQ>, Earliest review date of Oct. 11, 2017, Downloaded on Jan. 5, 2019.

“Spigen Rugged Armor Moto X4 Case with Resilient Shock Absorption and Carbon Fiber Design for Moto X4—Black”, <https://www.amazon.com/dp/B072N3WT4J>, Earliest review date of Oct. 22, 2017, Downloaded on Jul. 17, 2018.

“Spigen Rugged Armor Galaxy A8 (2016) Case with Resilient Shock Absorption and Carbon Fiber Design for Galaxy A8 (2016)—Black”, <https://www.amazon.com/dp/B01M26EX8X>, Earliest review date of Oct. 25, 2017, Downloaded on Jul. 17, 2018.

“Caseology Vault for iPhone Xs Case (2018)/iPhone X Case (2017)—Rugged Matte Finish—Black”, <https://www.amazon.com/Caseology-Vault-iPhone-Xs-Case/dp/B07533BBZ4>, Date First Available Sep. 19, 2017, Downloaded on Sep. 3, 2020.

“Spigen Rugged Armor Huawei P8 Lite Case with Resilient Shock Absorption and Carbon Fiber Design for Huawei P8 Lite (2015)—Black”, <https://www.amazon.com/dp/B01DLODME6>, Earliest review date of Jun. 1, 2016, Downloaded on Oct. 16, 2020.

* cited by examiner

FIG. 1

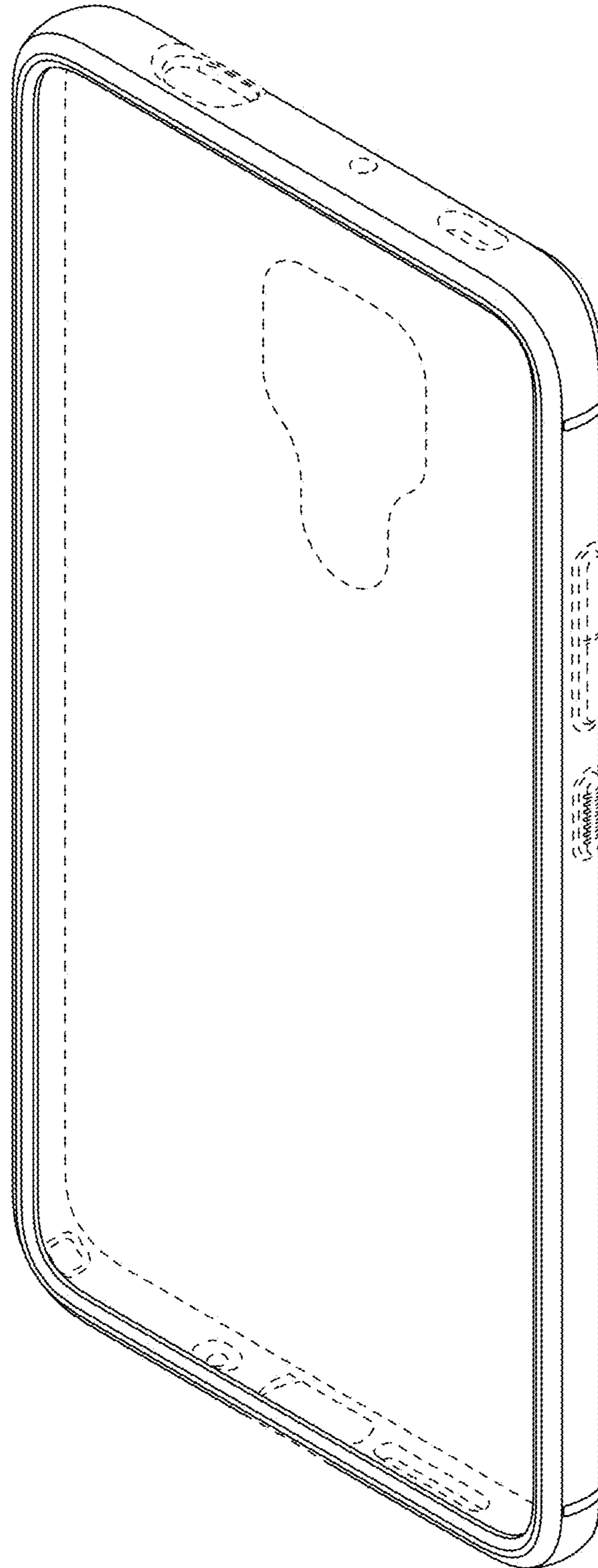

FIG. 2

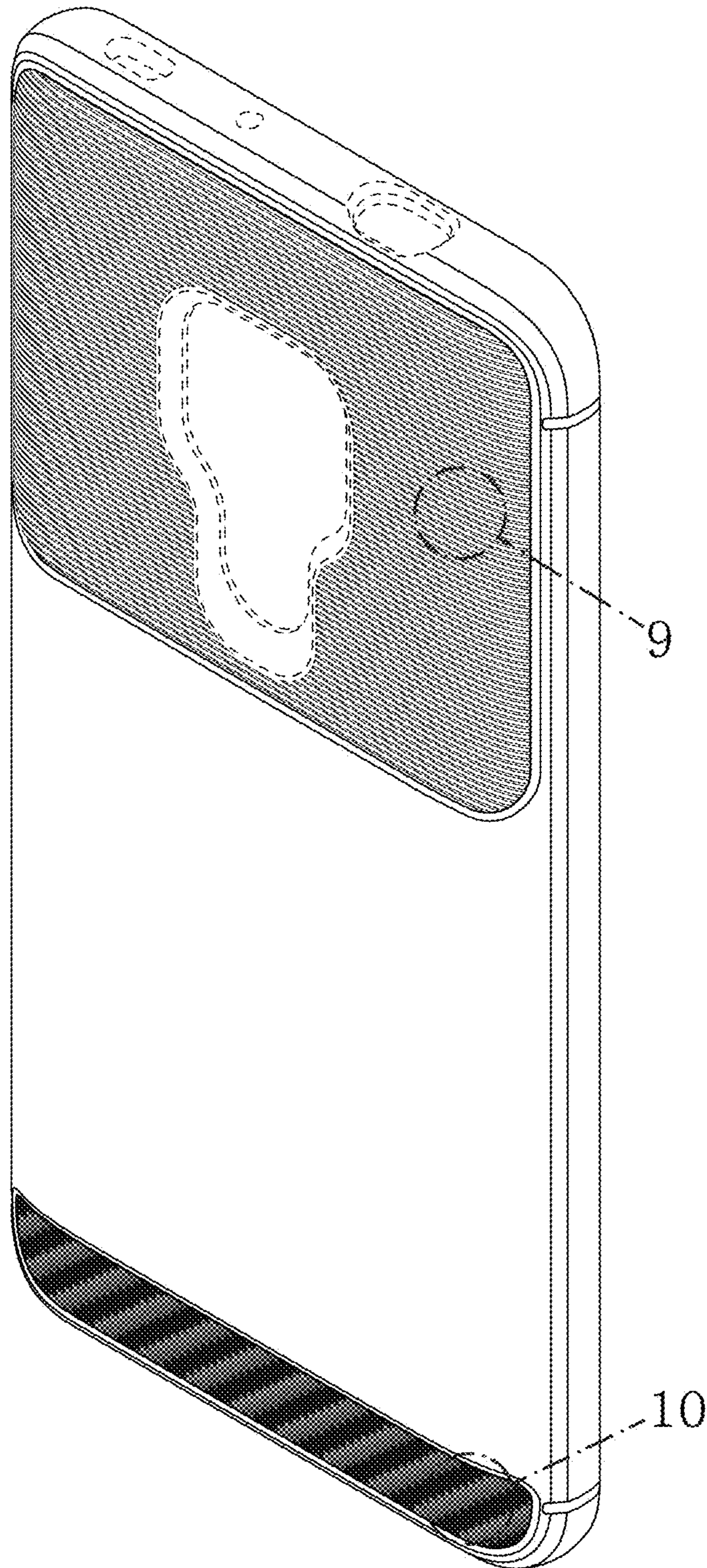

FIG. 3

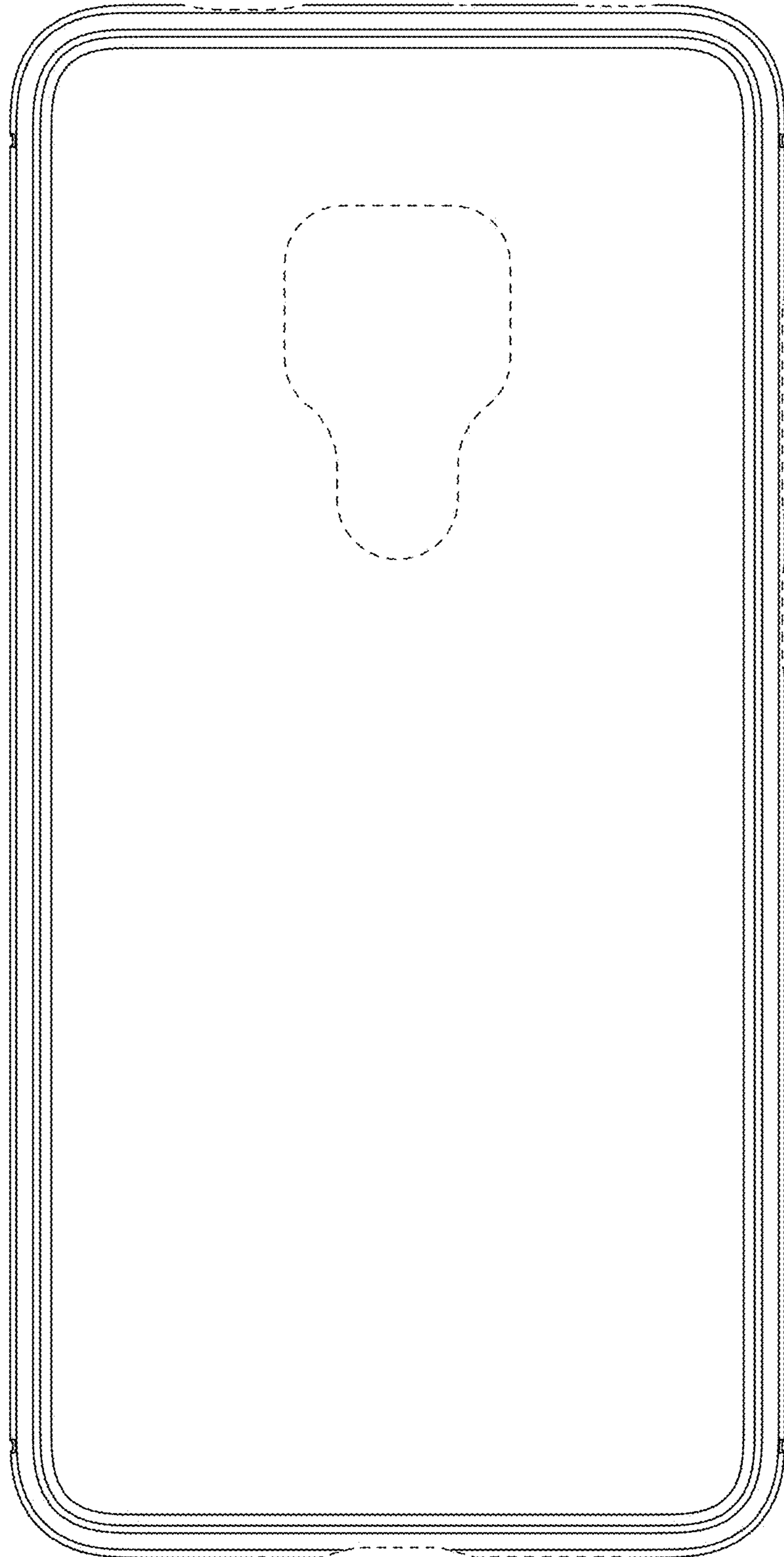

FIG. 4

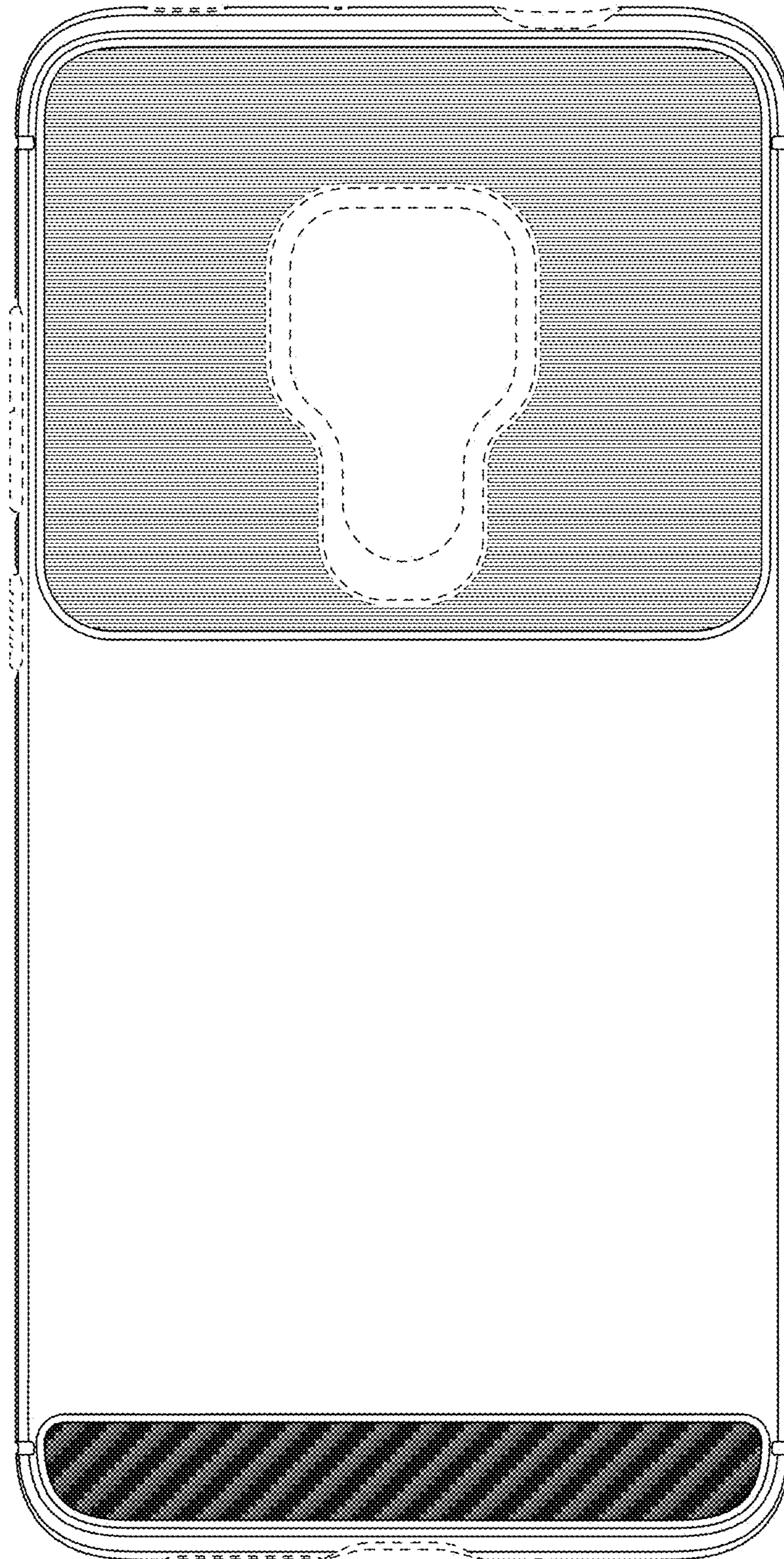

FIG. 5

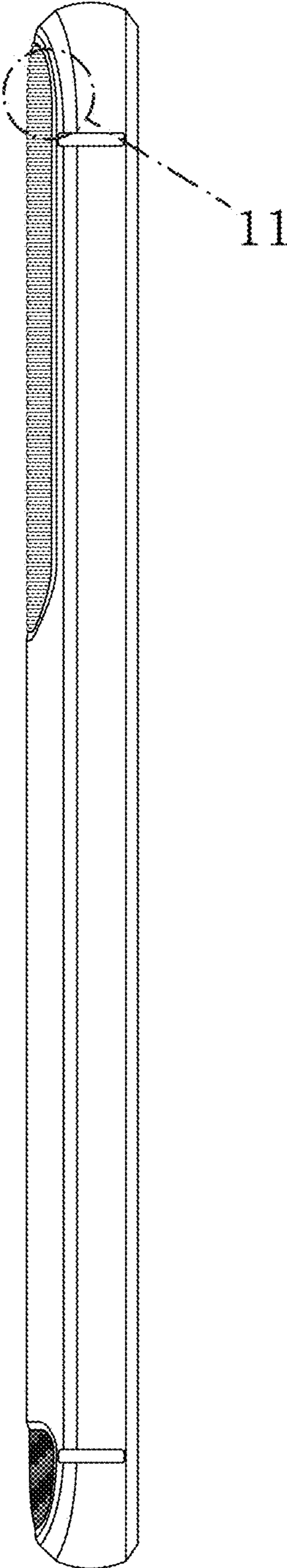

FIG. 6

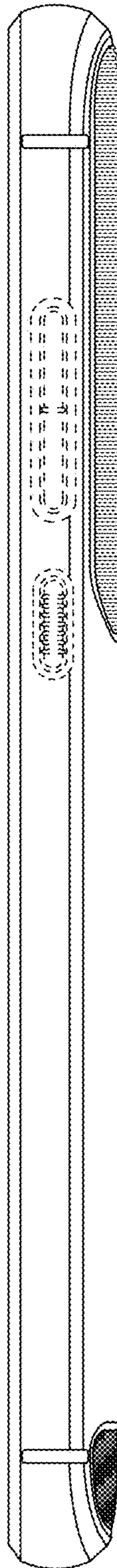

FIG. 7

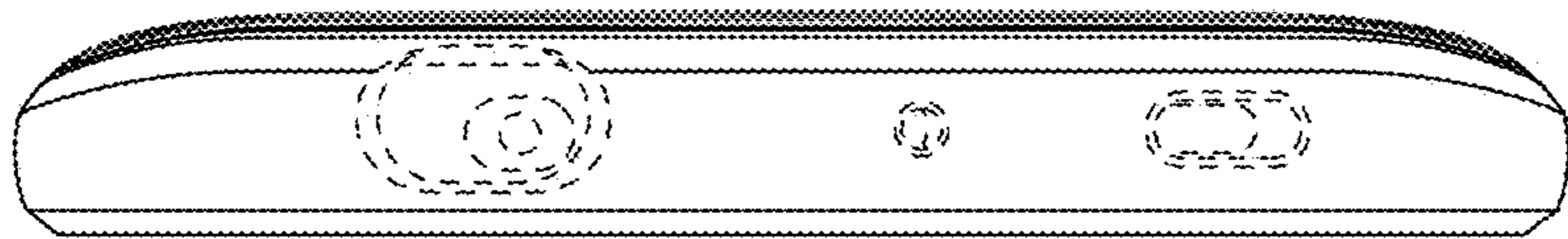

FIG. 8

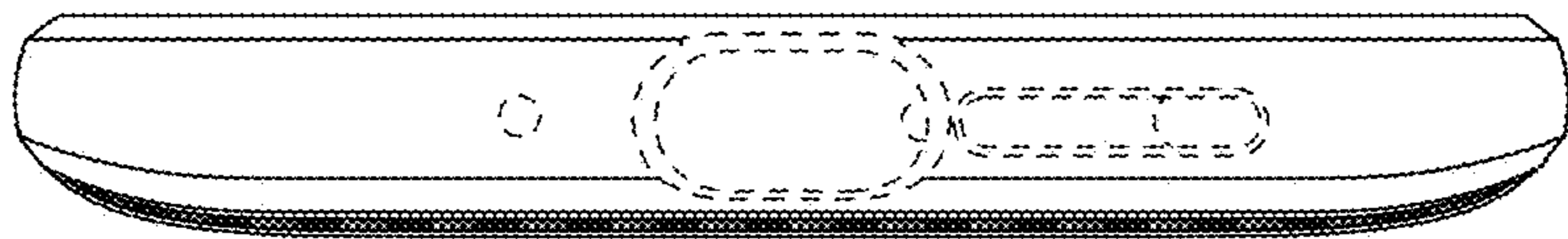

FIG. 9

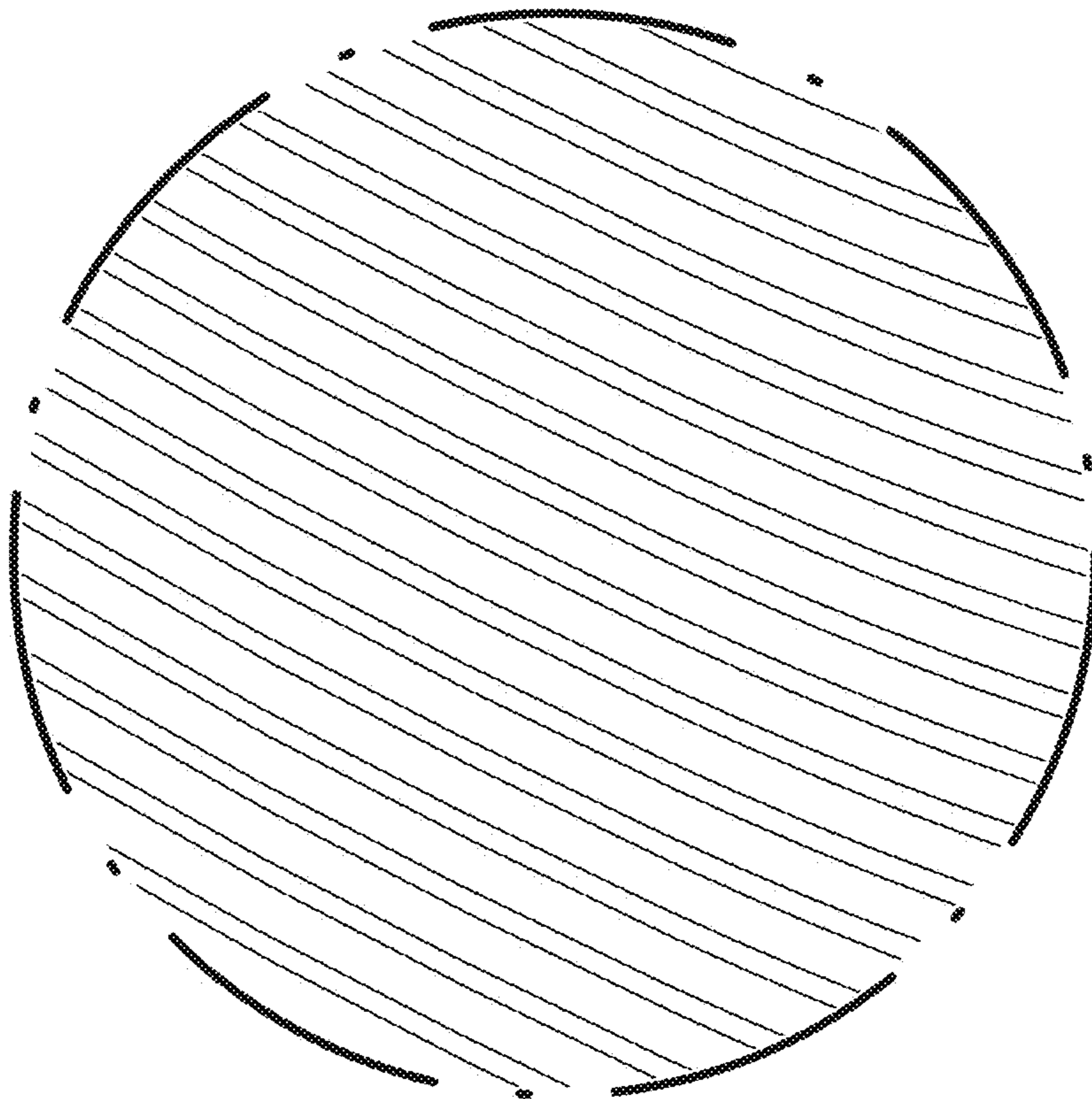

FIG. 10

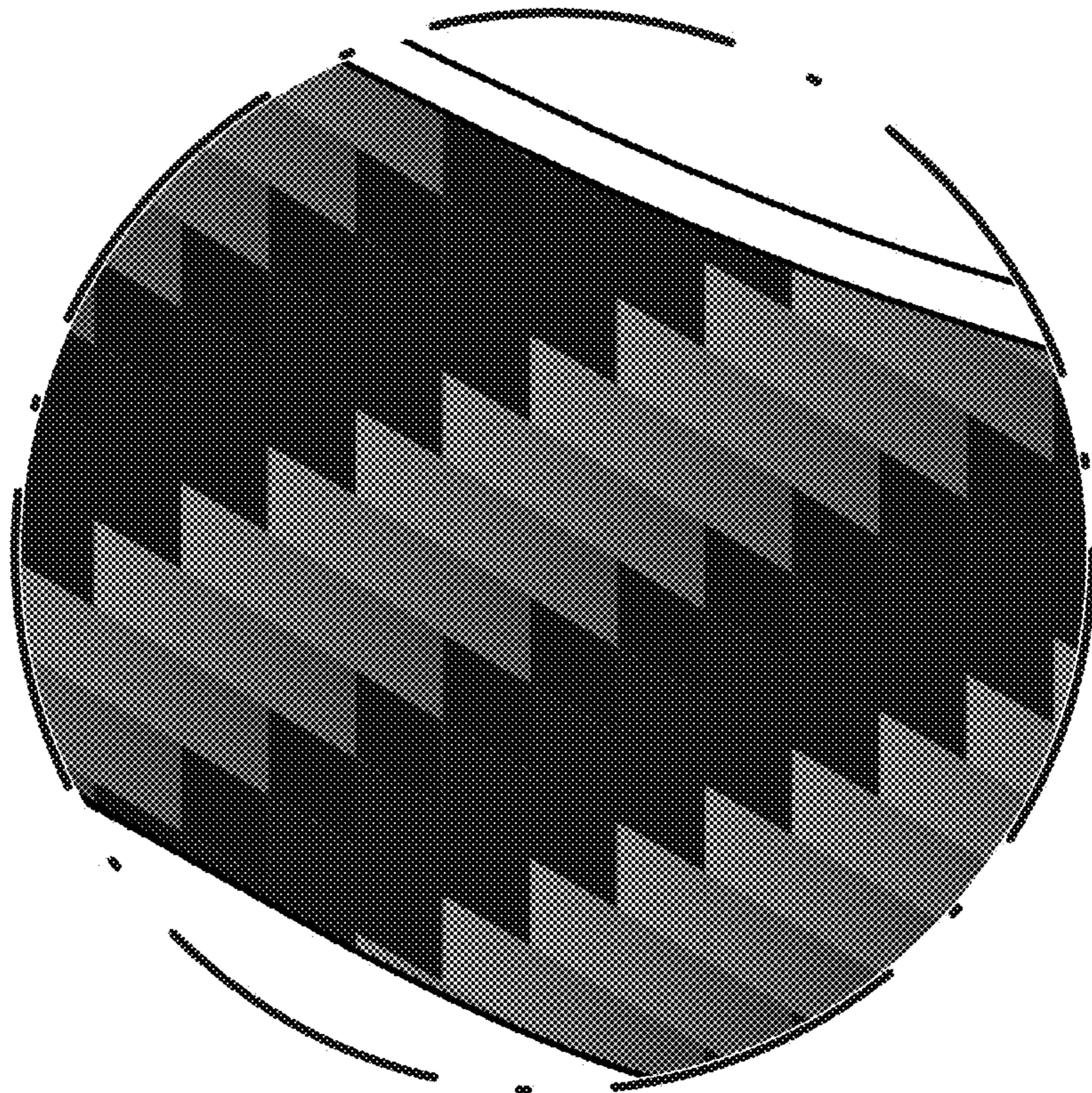

FIG. 11

