

US00D907407S

(12) **United States Design Patent**  
**Davis et al.**

(10) **Patent No.:** **US D907,407 S**  
(45) **Date of Patent:** **\*\* Jan. 12, 2021**

(54) **DESK**

D235,296 S 6/1975 Ginat  
D237,931 S 12/1975 Bradenfels  
D244,913 S 7/1977 Bradenfels

(71) Applicant: **WALKER EDISON FURNITURE COMPANY LLC**, Salt Lake City, UT (US)

(Continued)

(72) Inventors: **Matthew Davis**, Murray, UT (US);  
**Brad Bonham**, Draper, UT (US);  
**Richard A. Packer**, Kaysville, UT (US)

**OTHER PUBLICATIONS**

Wilmette Cherry Desk with Shelves, by Flash Furniture—The Classy Home <https://www.theclassyhome.com/Product/FLF-NAN-JN-21711-GG/Flash+Furniture+Wilmette+Cherry+Desk+with+Shelves> retrieved from the internet on May 17, 2020.\*

(Continued)

(73) Assignee: **Walker Edison Furniture Company LLC**, Salt Lake City, UT (US)

*Primary Examiner* — Mary Ann Calabrese

(\*\*) Term: **15 Years**

(74) *Attorney, Agent, or Firm* — Workman Nydegger

(21) Appl. No.: **29/677,750**

(57)

**CLAIM**

The ornamental design for a desk, as shown and described.

(22) Filed: **Jan. 23, 2019**

**DESCRIPTION**

(51) **LOC (13) Cl.** ..... **06-03**

(52) **U.S. Cl.**

USPC ..... **D6/654.1**

(58) **Field of Classification Search**

USPC ..... D6/641–644, 647, 654, 654.1, 654.11, D6/654.14

CPC .. A47B 7/00; A47B 9/00; A47B 13/00; A47B 13/02; A47B 13/04; A47B 13/06; A47B 13/08; A47B 13/10; A47B 13/12; A47B 17/00; A47B 17/006; A47B 17/033; A47B 19/00; A47B 21/00; A47B 2200/0001; A47B 2200/0011; A47B 2200/002

See application file for complete search history.

FIG. 1 is a front perspective view for a desk showing our new design;

FIG. 2 is a front elevation view thereof;

FIG. 3 is a back elevation view thereof;

FIG. 4 is a top plan view thereof;

FIG. 5 is a bottom plan view thereof;

FIG. 6 is a right elevation view thereof;

FIG. 7 is a left elevation view thereof;

FIG. 8 is a front perspective view of an alternate embodiment for a desk showing our new design, with simulated wood grain finish on the surfaces indicated;

FIG. 9 is a front elevation view thereof;

FIG. 10 is a back elevation view thereof;

FIG. 11 is a top plan view thereof;

FIG. 12 is a bottom plan view thereof;

FIG. 13 is a right elevation view thereof; and,

FIG. 14 is a left elevation view showing the new design.

The broken lines in the drawings are for the purpose of illustrating portions of the article that form no part of the claimed design.

(56) **References Cited**

**U.S. PATENT DOCUMENTS**

1,776,471 A 9/1930 Kelly  
3,045,831 A 7/1962 Pendergrast  
D205,666 S 9/1966 Magnuson  
D213,809 S 4/1969 Redman  
D216,380 S 12/1969 Redman

**1 Claim, 8 Drawing Sheets**

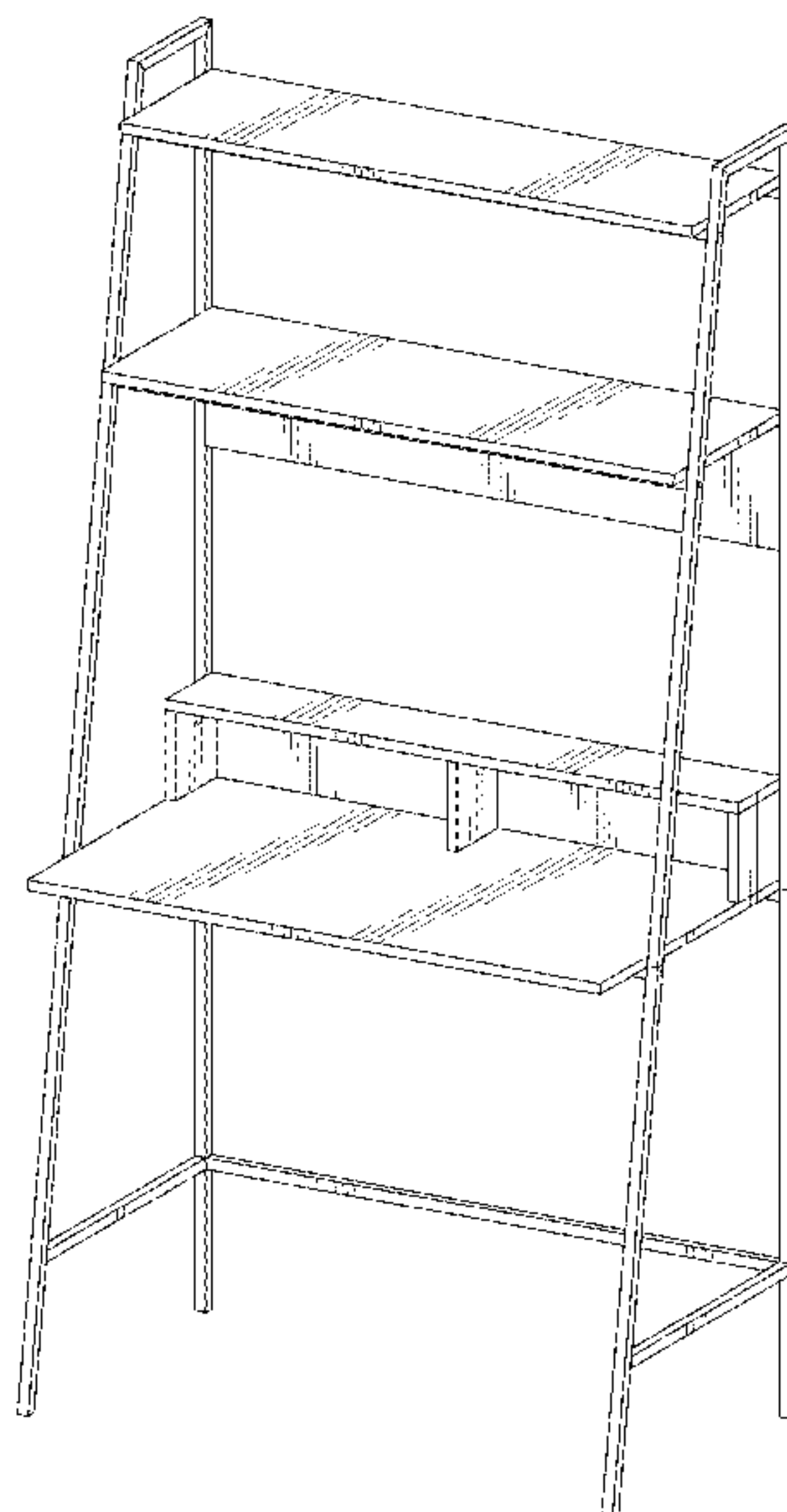

(56)

References Cited

U.S. PATENT DOCUMENTS

D248,915 S 8/1978 Brandenfels  
 D249,618 S 9/1978 Oxenhandler  
 D255,189 S 6/1980 Zapf  
 D259,007 S 4/1981 Schuckenbrock  
 4,905,609 A \* 3/1990 Haskins ..... A47B 13/06  
 108/23  
 5,240,127 A 8/1993 Levin  
 D345,454 S 3/1994 Hauglin  
 D363,623 S 10/1995 Rushing  
 D363,834 S 11/1995 Thompson  
 D369,035 S 4/1996 Potter  
 D372,105 S 7/1996 Plotner  
 D382,513 S 8/1997 Bozzone  
 D400,375 S 11/1998 Peng-Hui  
 D415,365 S 10/1999 Nicklas  
 D491,749 S 6/2004 Malizia  
 D492,861 S 7/2004 Lenger  
 D505,274 S 5/2005 Lai  
 D512,585 S 12/2005 Rozenboom  
 D527,208 S 8/2006 Malizia  
 D541,557 S 5/2007 Weatherly  
 D560,933 S 2/2008 Sexton  
 D582,188 S 12/2008 Martin  
 D591,533 S 5/2009 Karsson  
 7,641,294 B1 \* 1/2010 Goldberg ..... A47B 17/033  
 312/196  
 D609,501 S 2/2010 Sexton  
 D613,967 S 4/2010 Sexton  
 D614,421 S 4/2010 Sexton  
 D614,888 S 5/2010 Sexton  
 D620,729 S 8/2010 Snider  
 D624,200 S 9/2010 Kieffer  
 D632,900 S \* 2/2011 Goldberg ..... A47B 17/033  
 D6/654  
 D643,232 S 8/2011 Wagner  
 D653,475 S 2/2012 Thompson  
 D664,731 S 7/2012 Martin  
 D679,115 S 4/2013 Chavez  
 D685,851 S 7/2013 Offenkrantz  
 D716,080 S 10/2014 Bell  
 D747,124 S 1/2016 O'Donnell  
 9,332,838 B1 5/2016 Kilday  
 D760,516 S 7/2016 Yu  
 D779,240 S 2/2017 Tio  
 D784,738 S 4/2017 Wang  
 D785,981 S 5/2017 Kimmich  
 D805,329 S 12/2017 Rockwell  
 D808,200 S 1/2018 Davis  
 D808,203 S 1/2018 Davis

D852,555 S 7/2019 Fenneman  
 D853,762 S 7/2019 Tucker  
 D860,689 S 9/2019 Davis  
 D864,625 S 10/2019 Rockwell  
 D864,627 S 10/2019 Rockwell  
 D871,116 S 12/2019 Li  
 D874,191 S 2/2020 Qi  
 D878,115 S 3/2020 Rau  
 D883,719 S 5/2020 Li  
 D885,806 S 6/2020 Rockwell  
 10,689,793 B2 6/2020 Glass

OTHER PUBLICATIONS

Mid Century Modular Elias Desk With Shelf—Cost Plus World Market <https://www.worldmarket.com/product/mid+century+modular+elias+desk+with+shelf.do?sortby=ourPicks&from=fn> retrieved from the internet on May 17, 2020.\*  
 Designa Computer Desk with Bookshelf—Amazon.com [https://www.amazon.com/dp/B081DXDXW1/ref=sspa\\_dk\\_detail\\_3?psc=1&pd\\_rd\\_i=B081DXD](https://www.amazon.com/dp/B081DXDXW1/ref=sspa_dk_detail_3?psc=1&pd_rd_i=B081DXD) retrieved from the internet on May 17, 2020.\*  
 U.S. Appl. No. 29/656,483, filed Jul. 12, 2018, Davis.  
 U.S. Appl. No. 29/656,495, filed Jul. 12, 2018, Davis.  
 U.S. Appl. No. 29/677,745, filed Jan. 23, 2019, Davis.  
 Jossandmain.com; Hall trees, site visited Apr. 23, 2019 <https://www.jossandmain.com/furniture/pdp/savarese-hall-tree-qpvr8639.html?refid=SBPrBAZI1bbsDRuWni7P5NMAIh1HWtn0UPzia1pwElxrII>.  
 Wayfair.com; Faulk Desk with Hutch, site visited Apr. 24, 2019, <https://www.wayfair.com/furniture/pdp/wrought-studio-faulk-desk-with-hutch-var6889.html?piid=&experientype=1>.  
 Wayfair.com; Cecil Solid Wood Leaning/Ladder Desk, site visited Apr. 24, 2019; <https://www.wayfair.com/furniture/pdp/17-stories-cecil-leaningladder-desk-sts1472.html?piid=&experientype=1>.  
 Wayfair.com; Ladder Desk, site visited Apr. 24, 2019; <https://www.wayfair.com/furniture/pdp/monarch-specialties-inc-ladder-desk-mnq2850.html?&experientype=1>.  
 U.S. Appl. No. 29/694,776, filed Jun. 13, 2019, Davis.  
 U.S. Appl. No. 29/656,495, Jun. 26, 2019, Notice of Allowance.  
 Potterybarn.com; Declan Entry Hall Tree, Burnished Pine; potterybarn.com/products/declan-entry-hall-tree/?isx=0.2 ; site visited Jun. 12, 2019;.  
 Walker Edison Solid Wood Angled Hall Tree, <https://www.totallyfurniture.com/68-solid-wood-angled-hall-tree-brown-walker-edison-ht68frabr> (Year: 2020).  
 U.S. Appl. No. 29/699,086, dated Sep. 9, 2020, Office Action.  
 U.S. Appl. No. 29/656,483, dated Sep. 11, 2020, Notice of Allowance.

\* cited by examiner



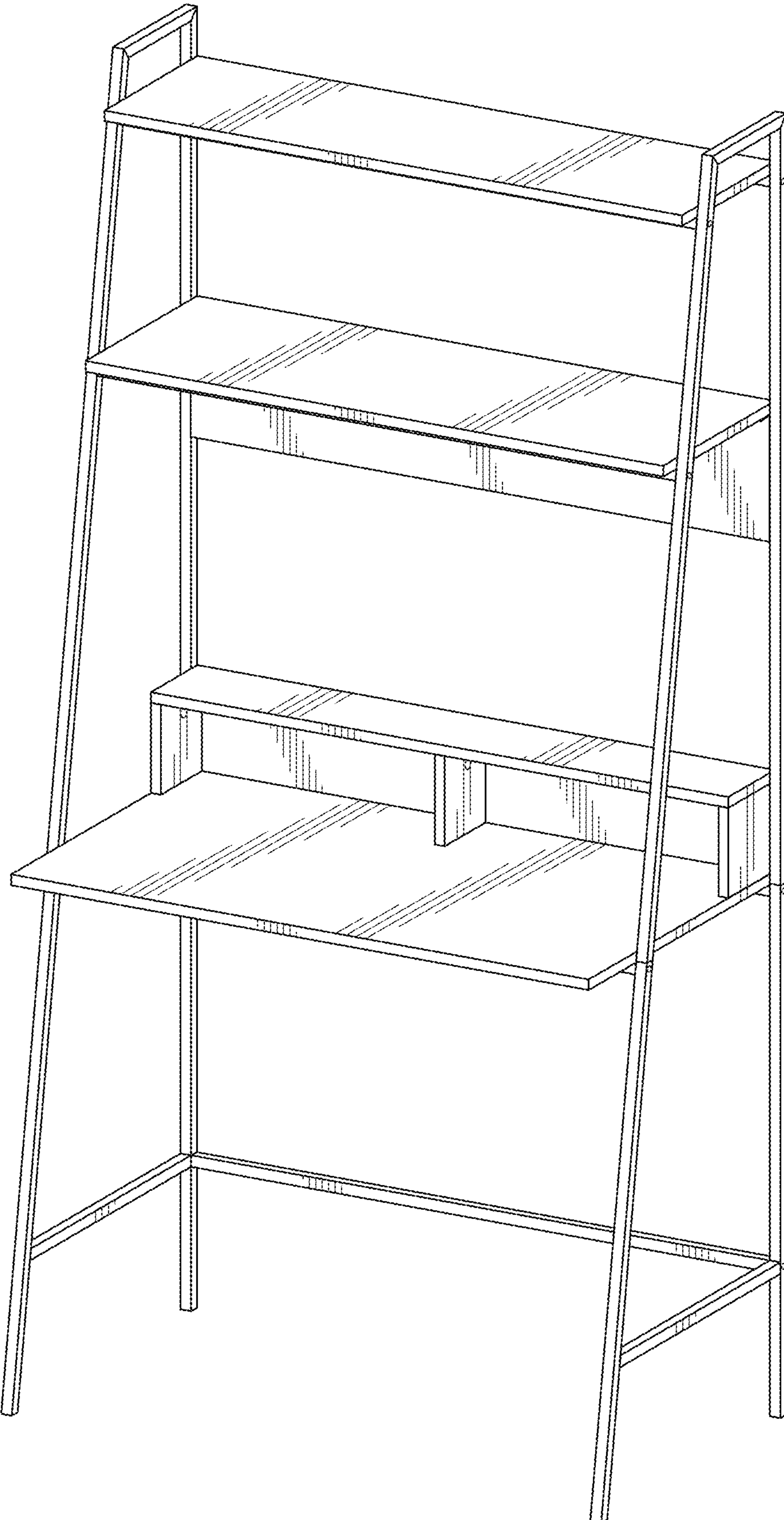

FIG. 1

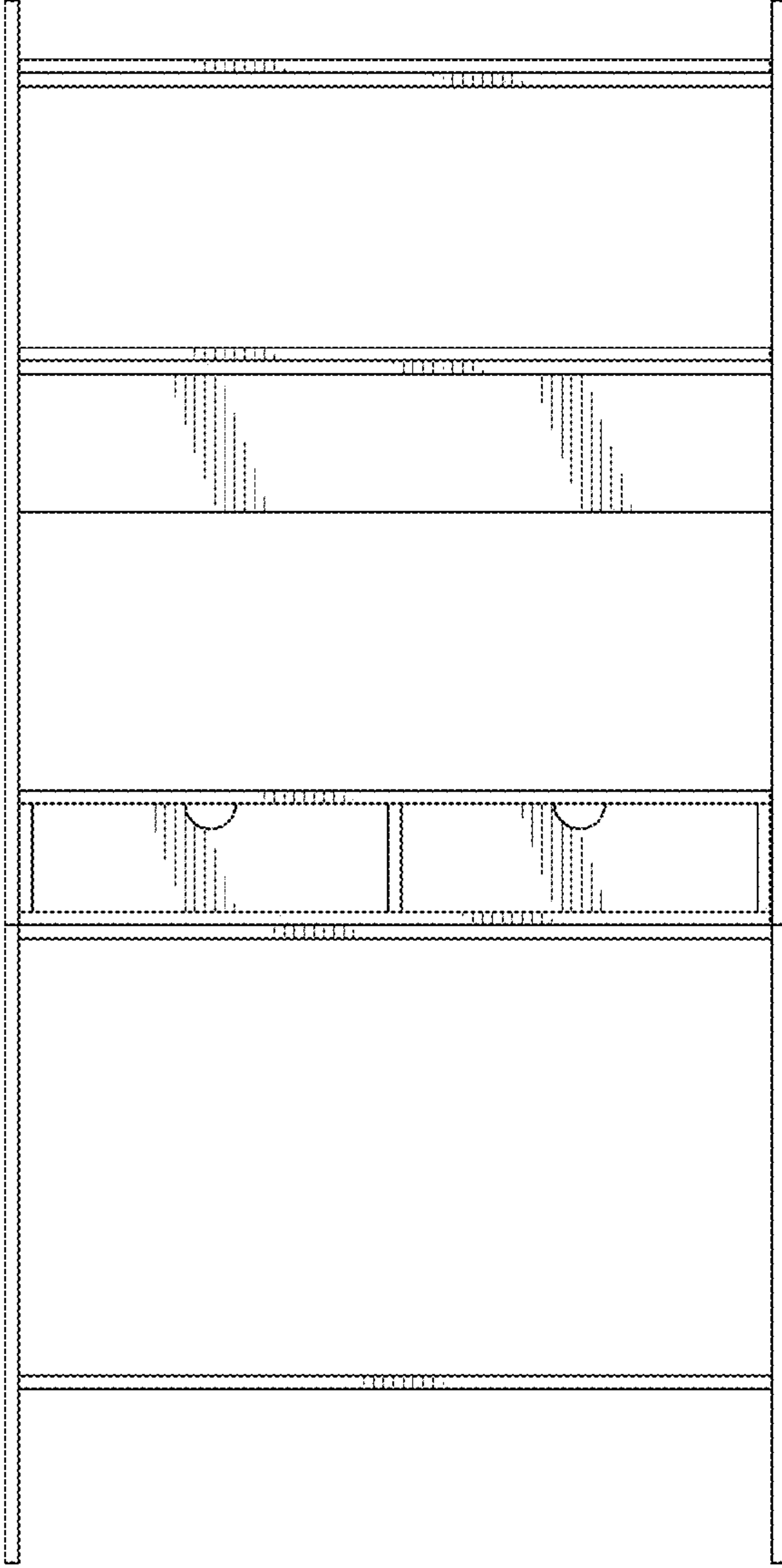

FIG. 2

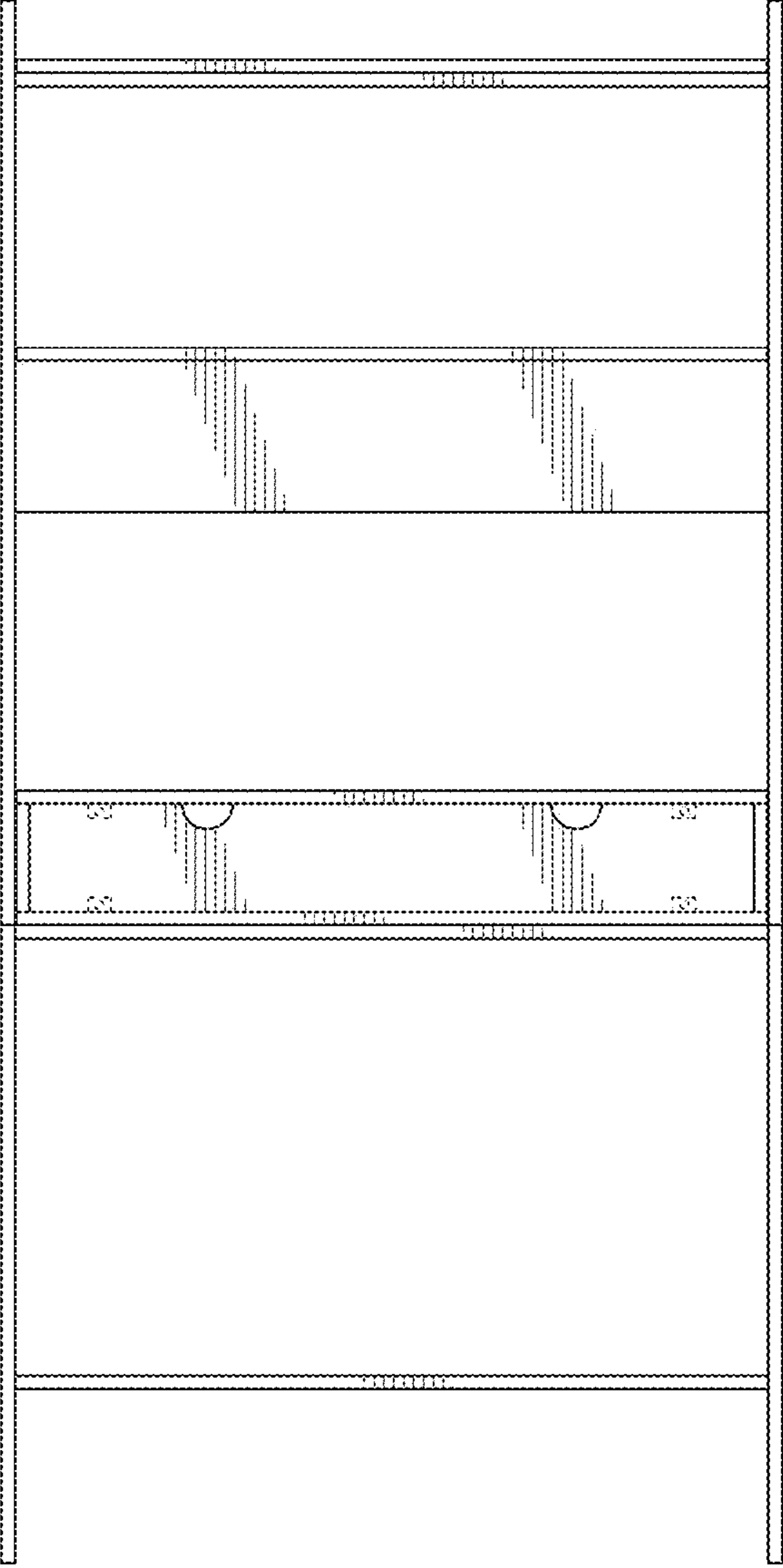

FIG. 3

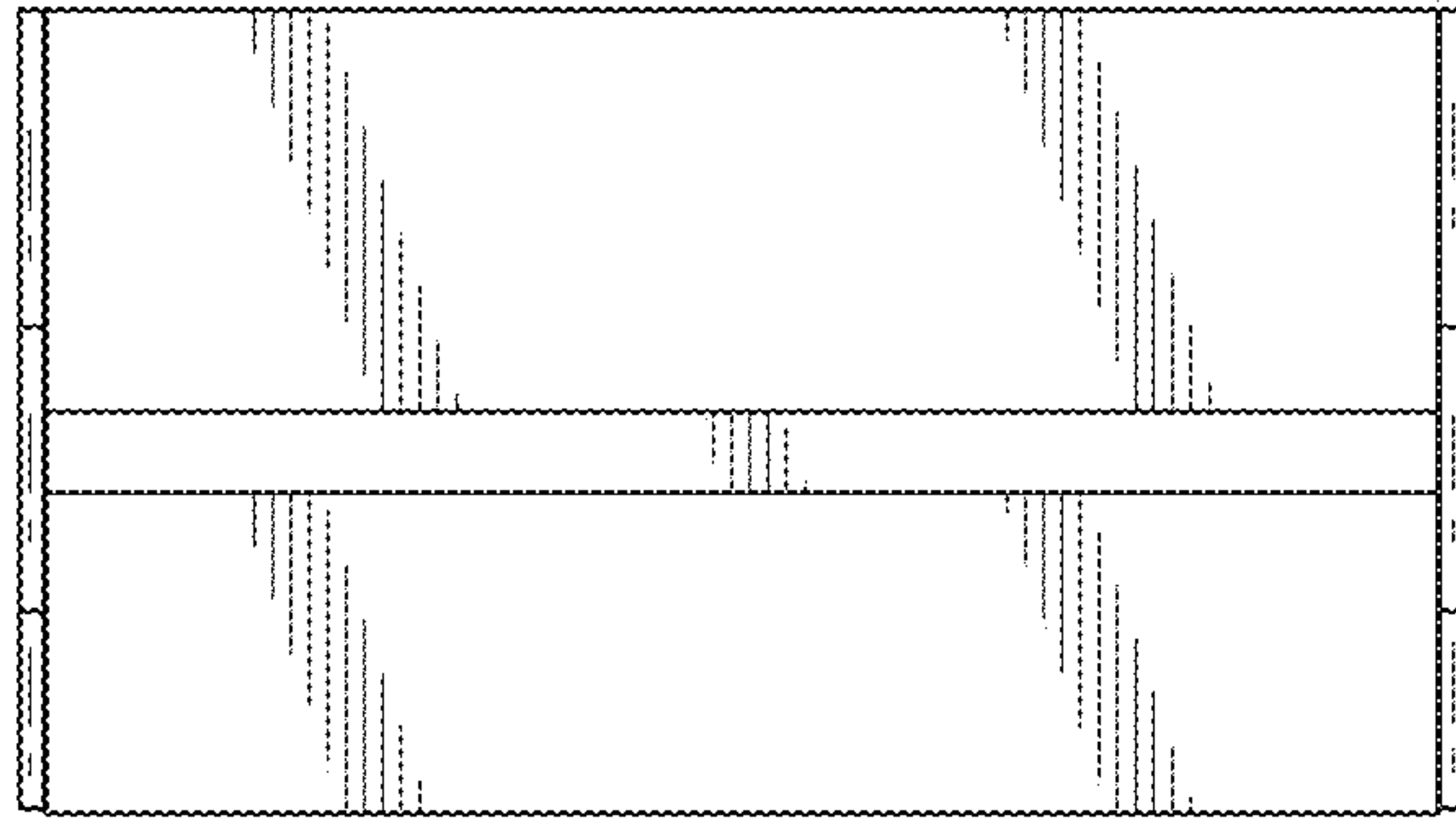

FIG. 4

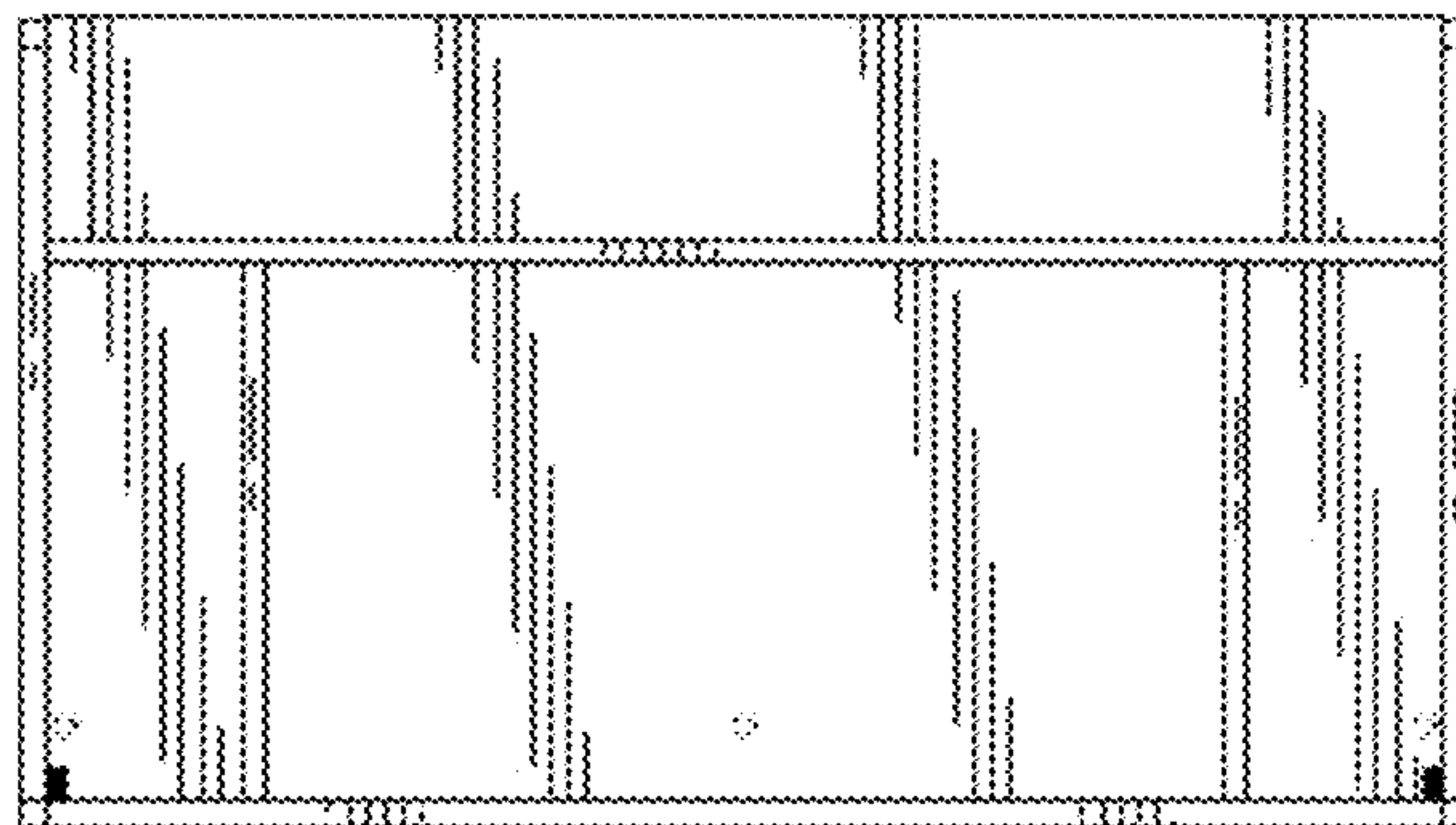

FIG. 5

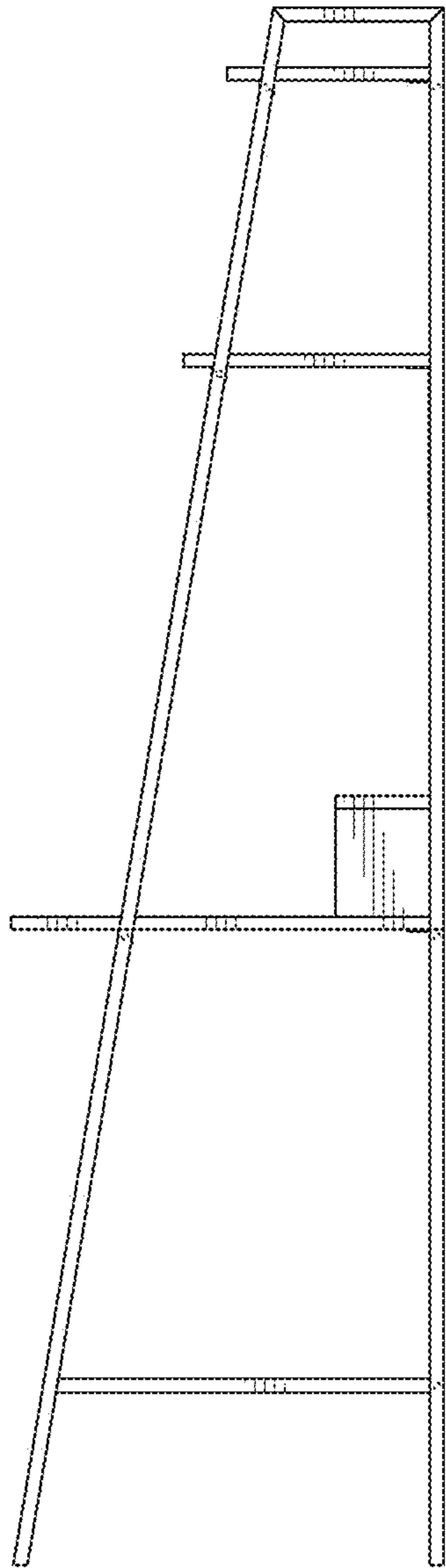

FIG. 6

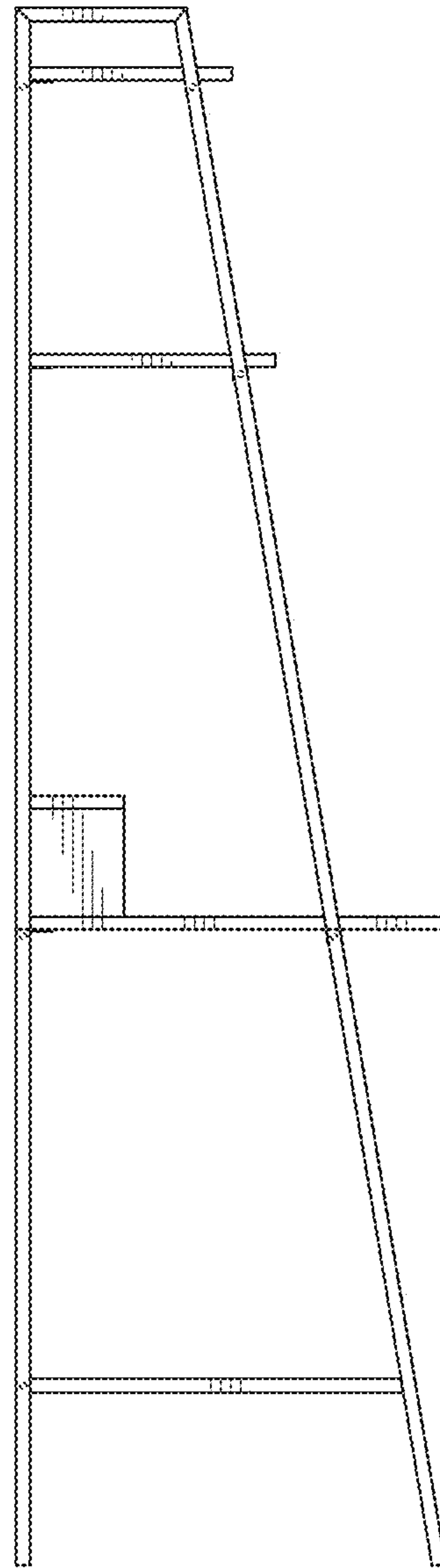

FIG. 7



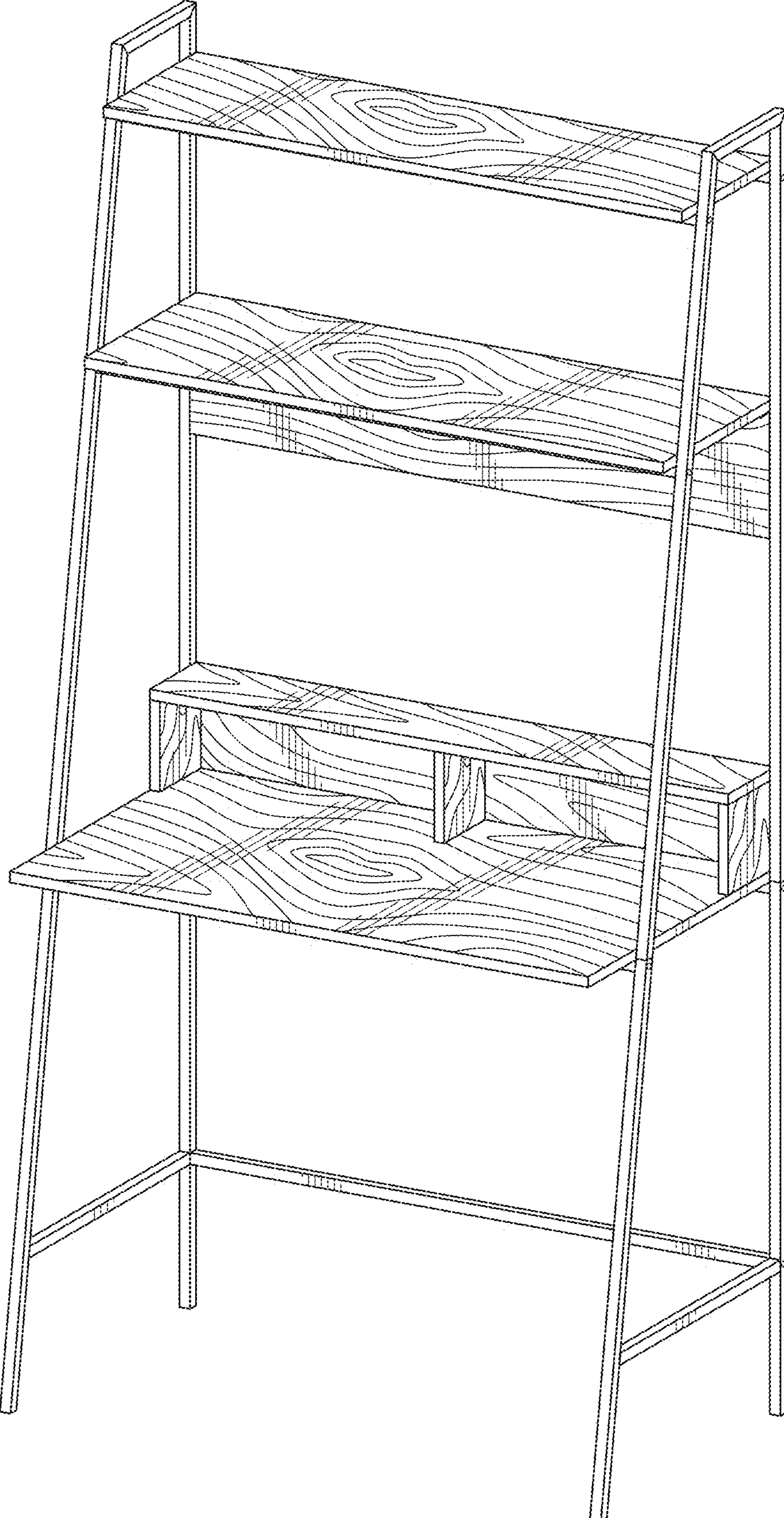

FIG. 8

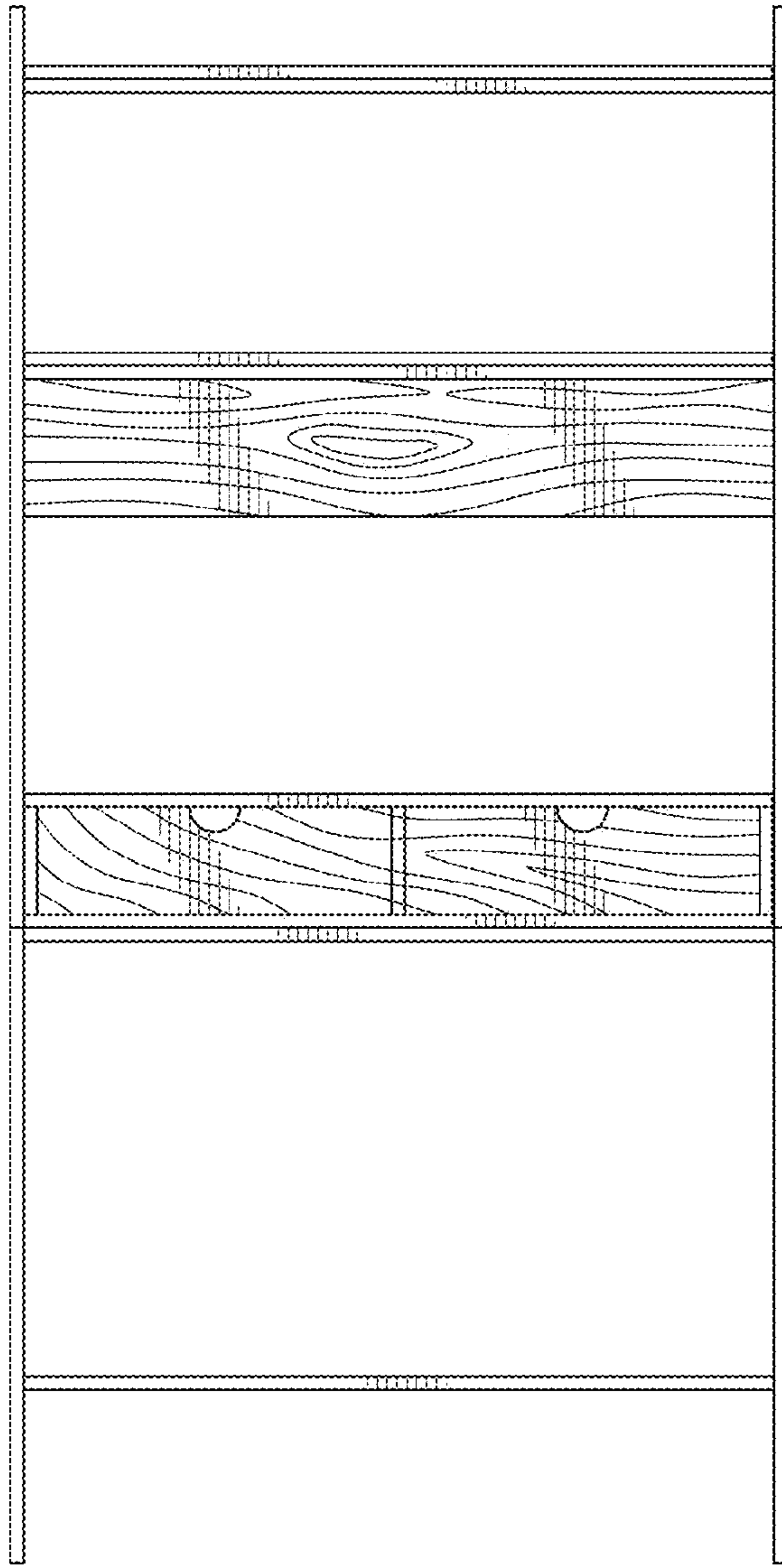

FIG. 9

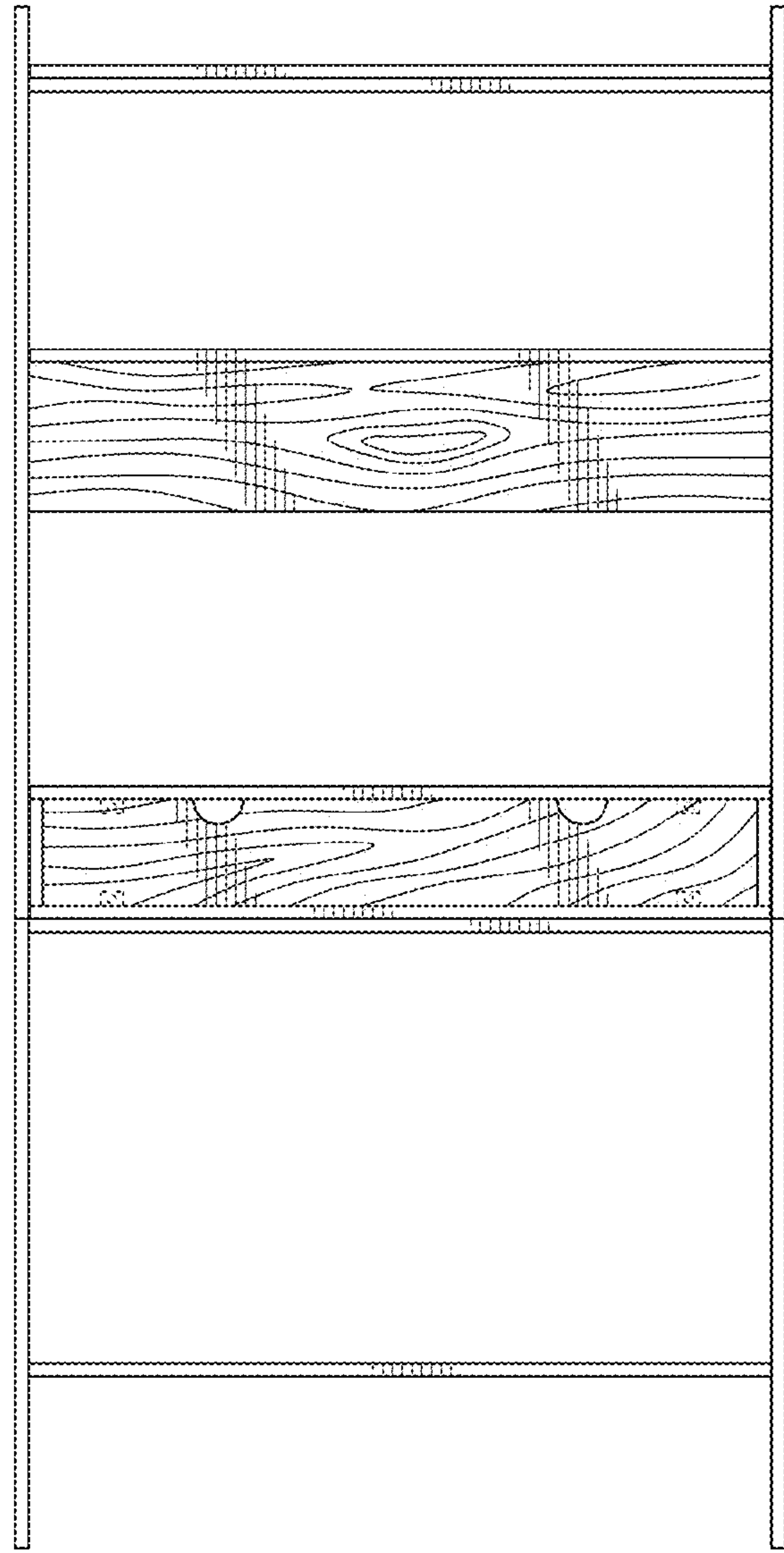

FIG. 10



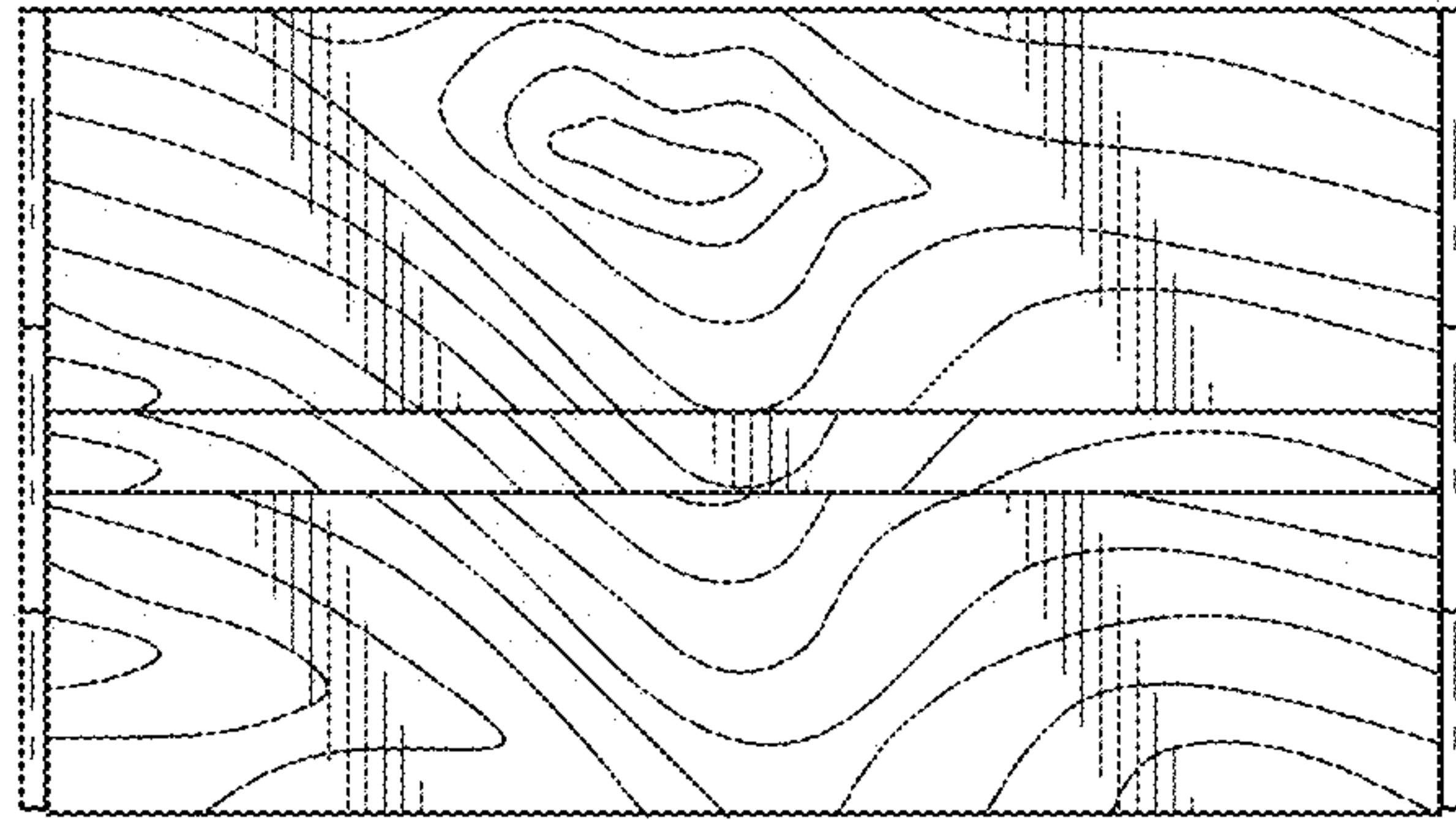

FIG. 11

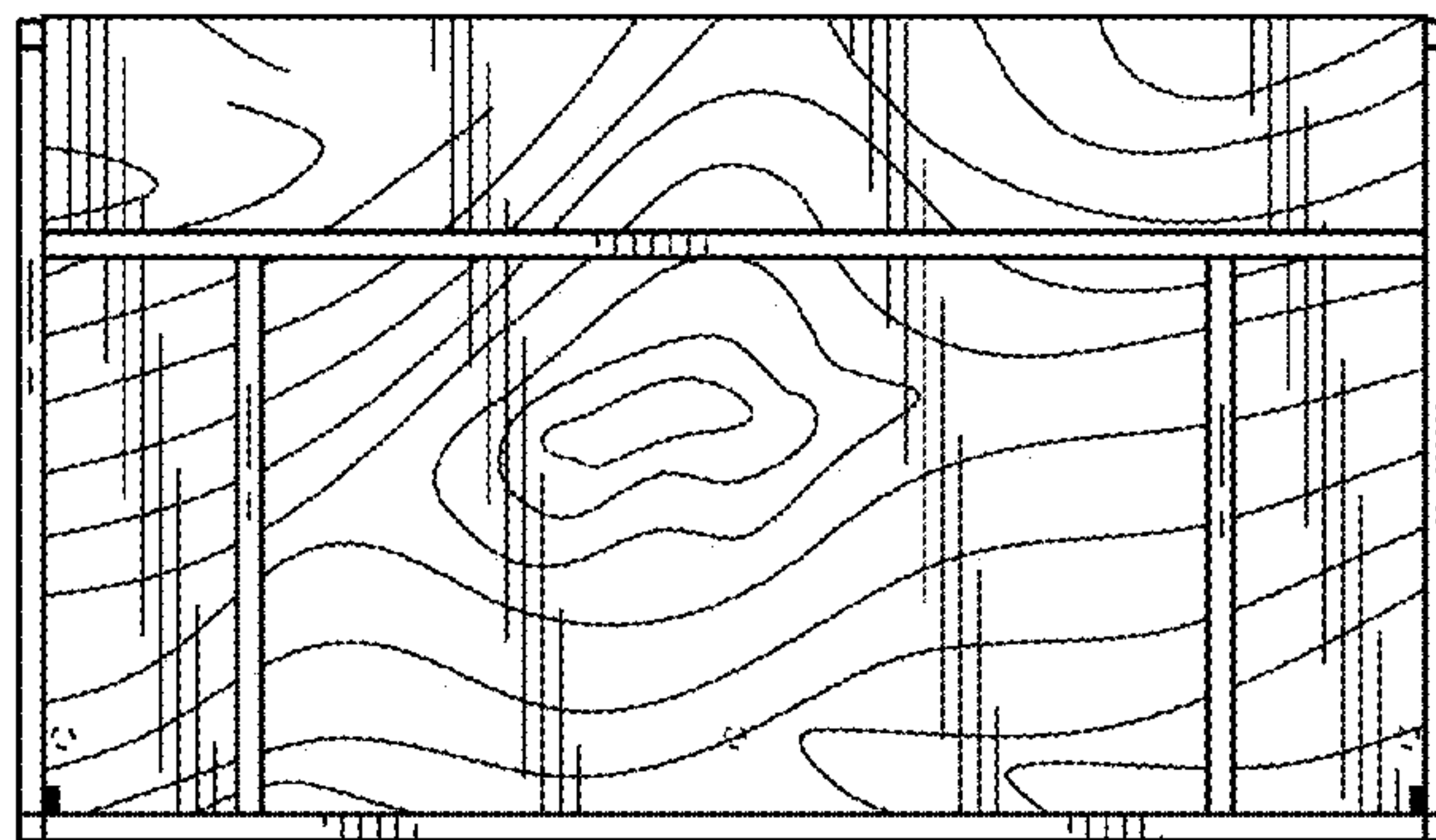

FIG. 12

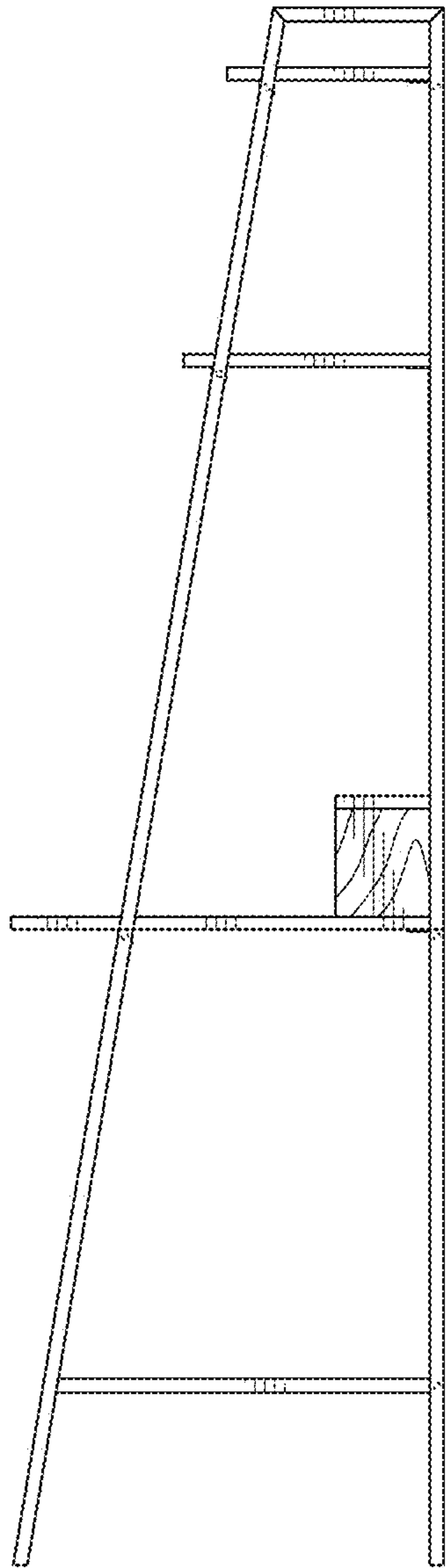

FIG. 13

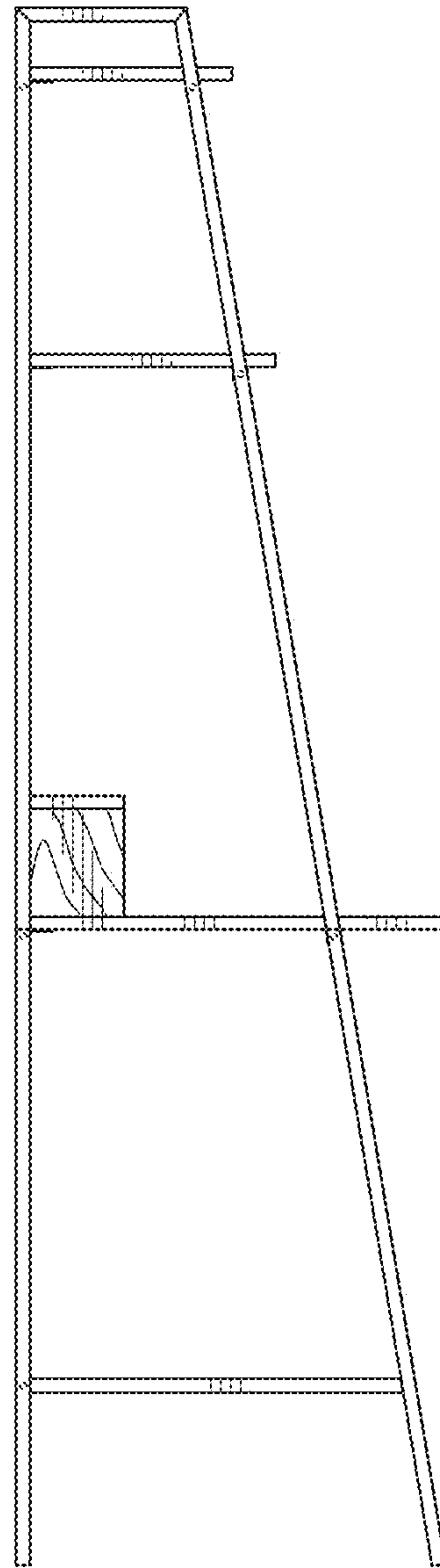

FIG. 14