



US00D907401S

(12) **United States Design Patent** (10) **Patent No.:** **US D907,401 S**
Joy (45) **Date of Patent:** **** Jan. 12, 2021**

(54) **FITTED TOP BEDSHEET**
(71) Applicant: **Margot Joy**, Cheyenne, WY (US)
(72) Inventor: **Margot Joy**, Cheyenne, WY (US)
(**) Term: **15 Years**
(21) Appl. No.: **29/741,651**
(22) Filed: **Jul. 15, 2020**
(51) **LOC (13) Cl.** **06-13**
(52) **U.S. Cl.**
USPC **D6/602**
(58) **Field of Classification Search**
USPC D6/333, 334, 335, 355, 356, 374, 716,
D6/716.1, 595, 596, 601, 602, 603, 606,
(Continued)

(56) **References Cited**
U.S. PATENT DOCUMENTS
2,695,414 A * 11/1954 Ford A47G 9/0246
5/485
4,316,299 A * 2/1982 Friedman A47G 9/02
5/485
(Continued)

OTHER PUBLICATIONS
Google search: "partial fitted sheet" [site visited Sep. 27, 2020]:
https://www.google.com/search?q=partial+fitted+sheet&newwindow=1&hl=en&sxsrf=ALeKk01F7SuahWbfdX3W6bhaadNS58ewSw:1601250881966&source=lnms&tbm=isch&sa=X&ved=2ahUKEwui6l-wxlrAhVwoHIEHRdGDWYQ_AUoAnoECA0QBA&biw=1200&bih=1777 (Year: 2020).*
(Continued)

Primary Examiner — Sanjeev Paul
(74) *Attorney, Agent, or Firm* — Michael D. Eisenberg

(57) **CLAIM**
The ornamental design for a fitted top bedsheet, as shown and described.

DESCRIPTION
FIG. 1 is a perspective view of a fitted top bedsheet showing my new design;
FIG. 2 is a top view of the fitted top bedsheet;
FIG. 3 is a right side view of the fitted top bedsheet;
FIG. 4 is a left side view of the fitted top bedsheet;
FIG. 5 is a rear view of the fitted top bedsheet;
FIG. 6 is a front view of the fitted top bedsheet; and
FIG. 7 is a bottom view of the fitted top bedsheet;
FIG. 8 is a perspective view of a second embodiment of the fitted top bedsheet;
FIG. 9 is a top view of the second embodiment of the fitted top bedsheet;
FIG. 10 is a right side view of the second embodiment of the fitted top bedsheet;
FIG. 11 is a left side view of the second embodiment of the fitted top bedsheet;
FIG. 12 is a rear view of the second embodiment of the fitted top bedsheet;
FIG. 13 is a front view of the second embodiment of the fitted top bedsheet; and
FIG. 14 is a bottom view of the second embodiment of the fitted top bedsheet;
FIG. 15 is a perspective view of a third embodiment of the fitted top bedsheet;
FIG. 16 is a top view of the third embodiment of the fitted top bedsheet;
FIG. 17 is a right side view of the third embodiment of the fitted top bedsheet;
FIG. 18 is a left side view of the third embodiment of the fitted top bedsheet;
FIG. 19 is a rear view of the third embodiment of the fitted top bedsheet;
FIG. 20 is a front view of the third embodiment of the fitted top bedsheet; and
FIG. 21 is a bottom view of the third embodiment of the fitted top bedsheet.

1 Claim, 9 Drawing Sheets

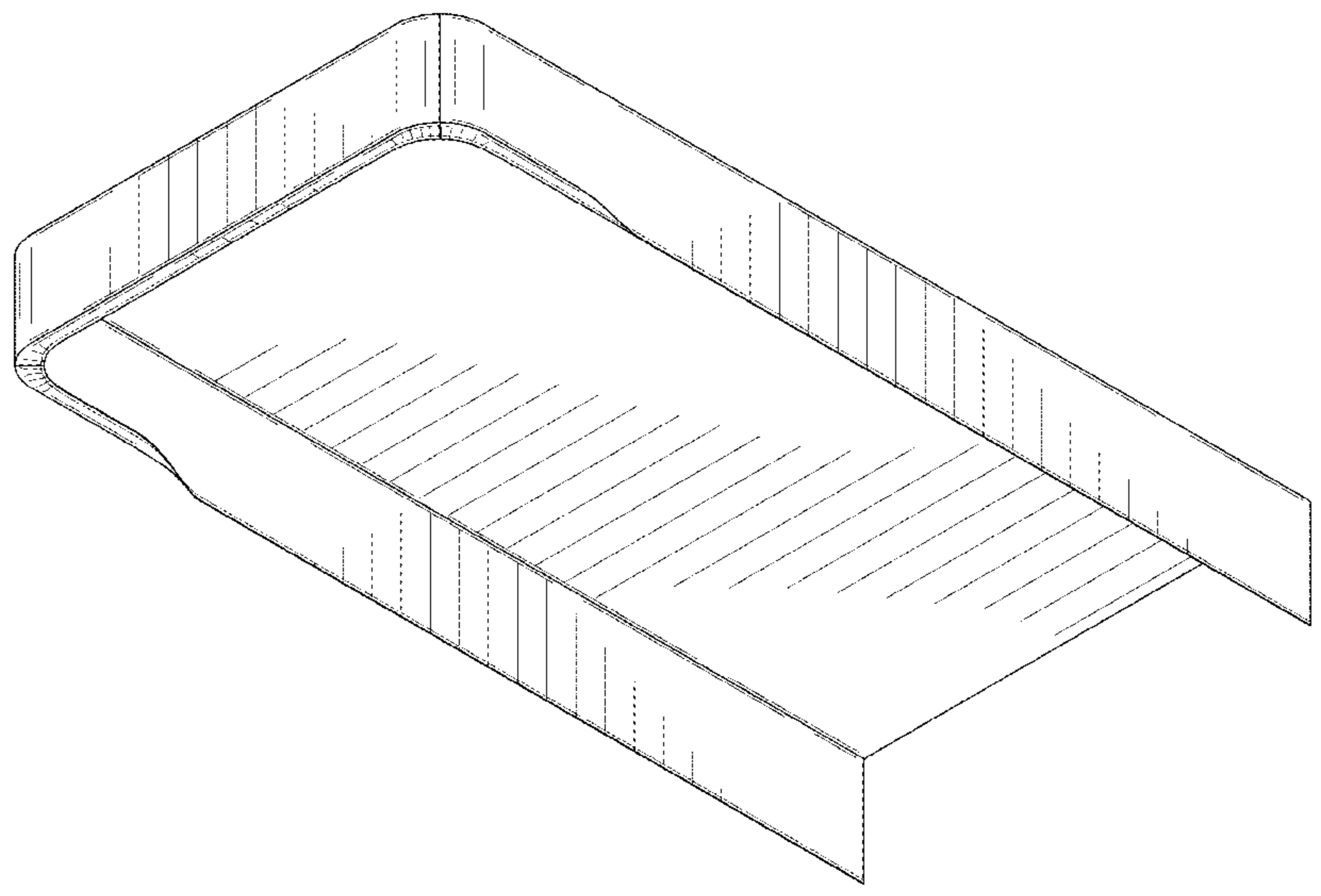

(58) **Field of Classification Search**

USPC D6/607; 5/490, 491, 493, 494, 489;
 297/1, 2, 4, 93, 180.11, 195.1, 195.11,
 297/195.13, 393, 397, 452.12, 452.14,
 297/452.15, 452.21, 452.24, 452.26,
 297/452.48, 452.62, 482; D24/183-185,
 D24/191
 CPC A47G 9/10; A47G 9/1045; A47G 9/0253;
 A47G 2009/1018; A47G 9/02; A47G
 9/0238; A47G 9/0246; A47G 9/00; A47G
 9/0292; A47G 9/06
 See application file for complete search history.

(56) **References Cited**

U.S. PATENT DOCUMENTS

4,964,184 A * 10/1990 Lewis A47G 9/02
 5/496
 5,189,744 A * 3/1993 Roberts A47G 9/0246
 5/497
 5,465,440 A * 11/1995 Heptner A47G 9/0246
 5/495
 D383,028 S * 9/1997 Pierce D6/602
 7,260,858 B2 * 8/2007 Cushing A47C 31/105
 5/494
 D623,884 S * 9/2010 Reilly D6/603
 D630,878 S * 1/2011 Kennett D6/603
 D674,645 S * 1/2013 Hengel D6/602
 D681,996 S * 5/2013 Jimenez-Hernandez D6/602
 D687,654 S * 8/2013 Jalan D6/602
 D698,587 S * 2/2014 Caines D6/602

D699,983 S * 2/2014 Polesuk D6/602
 D713,655 S * 9/2014 Blatt D6/596
 D778,638 S * 2/2017 Williams D6/602
 D792,124 S * 7/2017 Blatt D6/596
 D850,819 S * 6/2019 Lloyd-Caldwell D6/603
 D865,397 S * 11/2019 Goodger D6/603
 D867,787 S * 11/2019 Stricklen D6/602
 D871,110 S * 12/2019 Atkinson D6/606
 D891,150 S * 7/2020 Prashar D6/603
 2004/0200000 A1 * 10/2004 Harbin A47G 9/0246
 5/497
 2007/0000053 A1 * 1/2007 Yang A47G 9/02
 5/493
 2012/0324646 A1 * 12/2012 Briganti A47G 9/0246
 5/496
 2014/0352064 A1 * 12/2014 Blethen A47G 9/0246
 5/494
 2015/0007389 A1 * 1/2015 Blethen A47G 9/0246
 5/494
 2015/0040316 A1 * 2/2015 Graves A47G 9/0292
 5/493
 2020/0128979 A1 * 4/2020 Hinman A47G 9/0223

OTHER PUBLICATIONS

Google search: "half fitted sheet" [site visited Sep. 27, 2020]:
https://www.google.com/search?q=half+fitted+sheet&newwindow=1&hl=en&sxsrf=ALeKk02aOkNcpbZEU9yk0SxfLIX3qaVmGw:1601251296604&source=lnms&tbn=isch&sa=X&ved=2ahUKEwjhf1xYrsAhUAknIEHaXYBwkQ_AUoA3oECBMQBQ&biw=1200&bih=1777 (Year: 2020).*

* cited by examiner

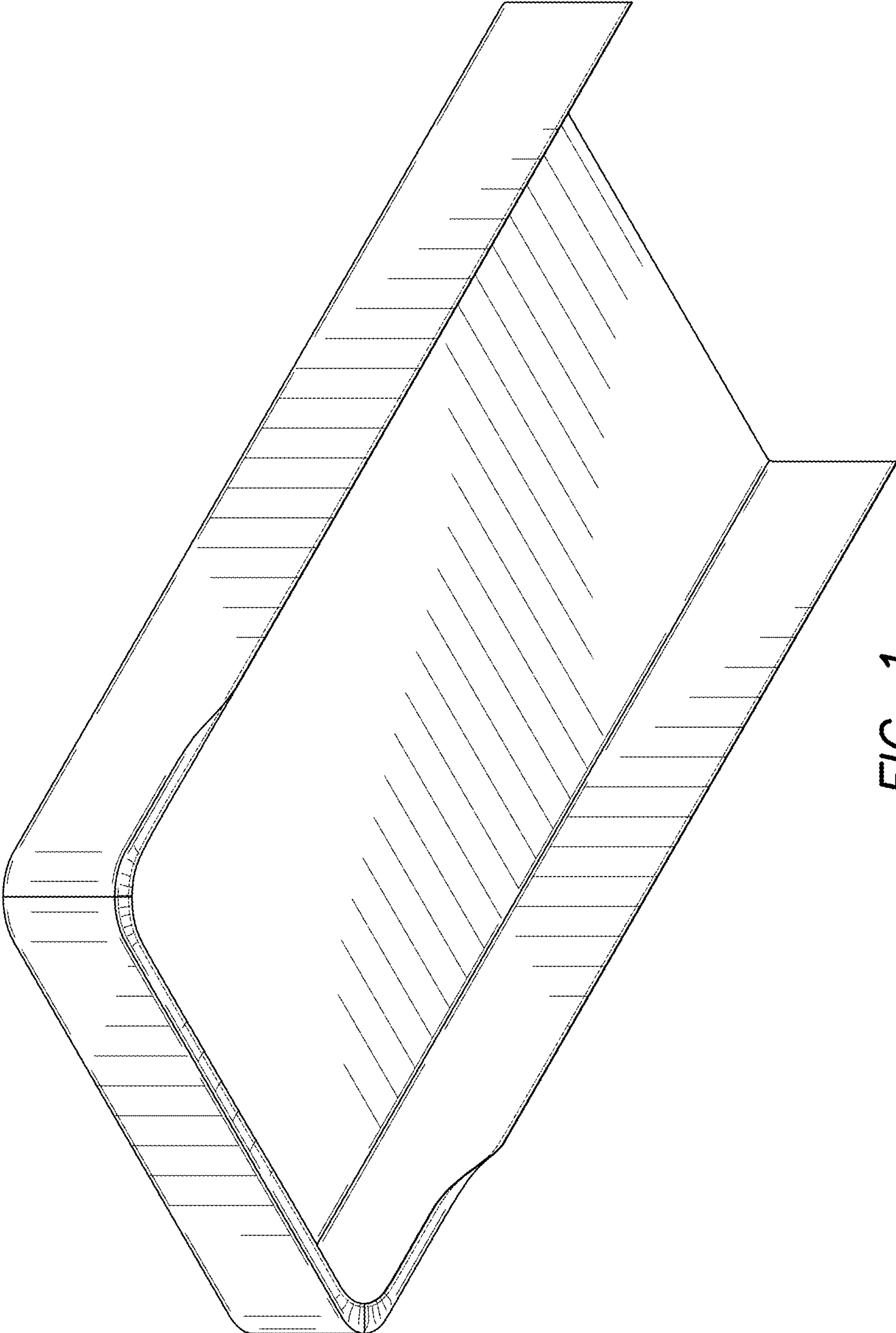

FIG. 1

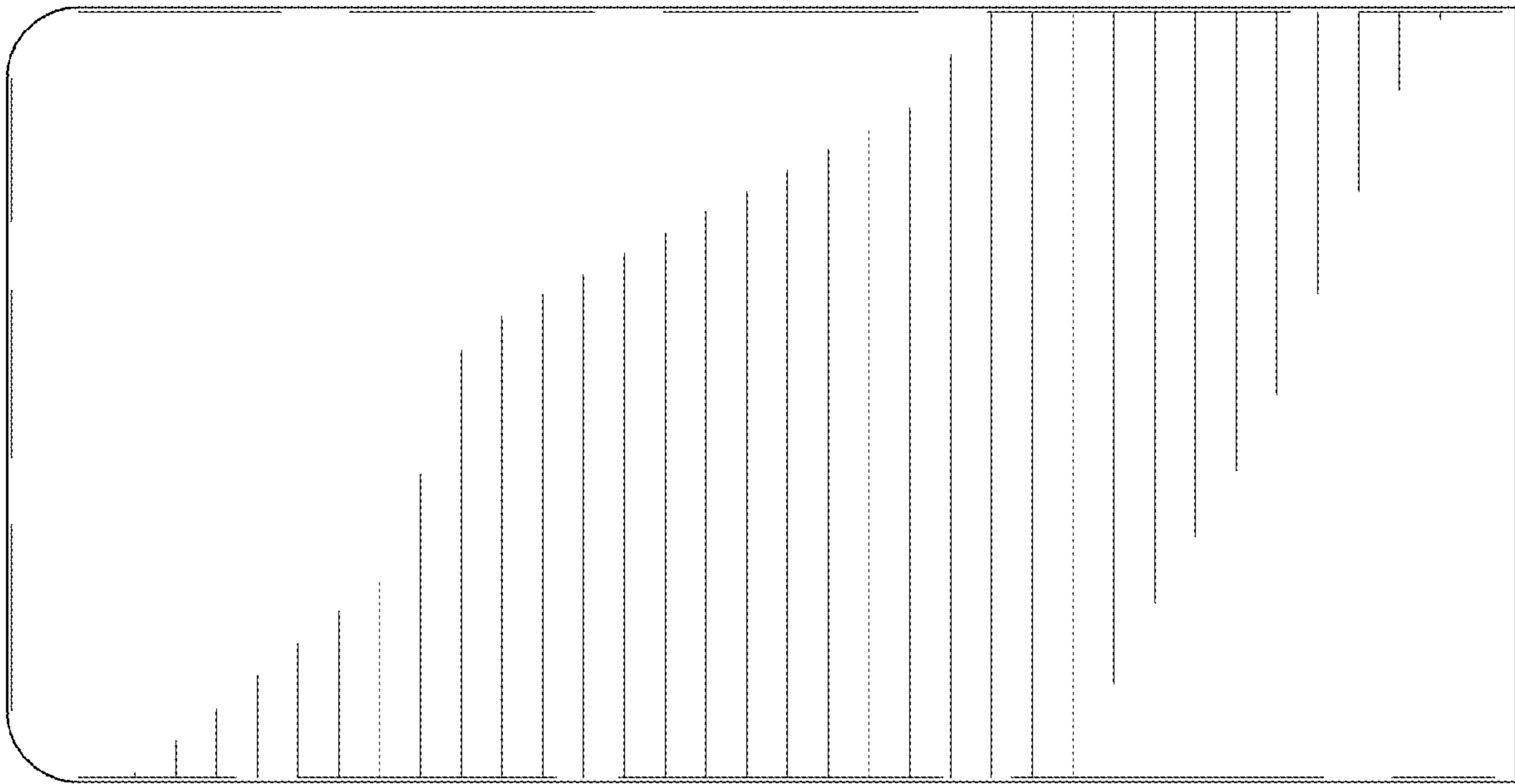

FIG. 2

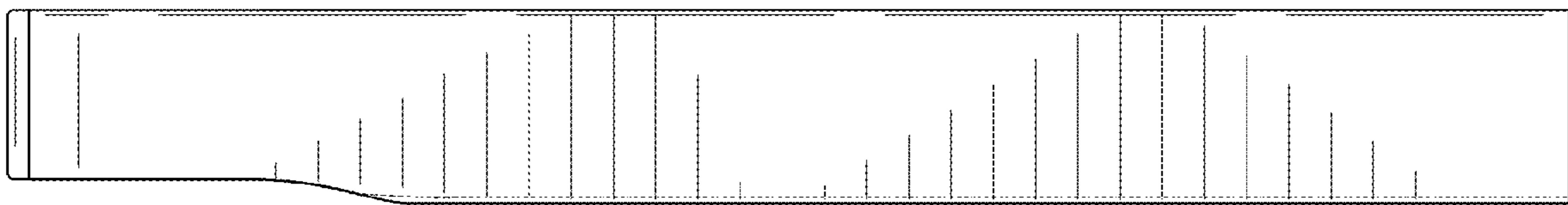

FIG. 3

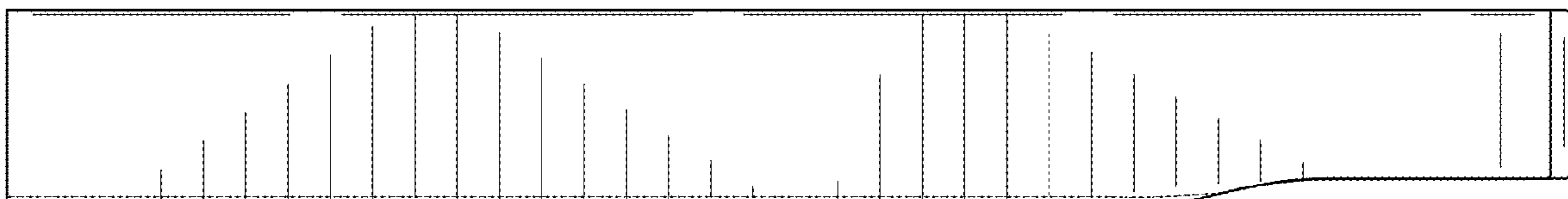

FIG. 4

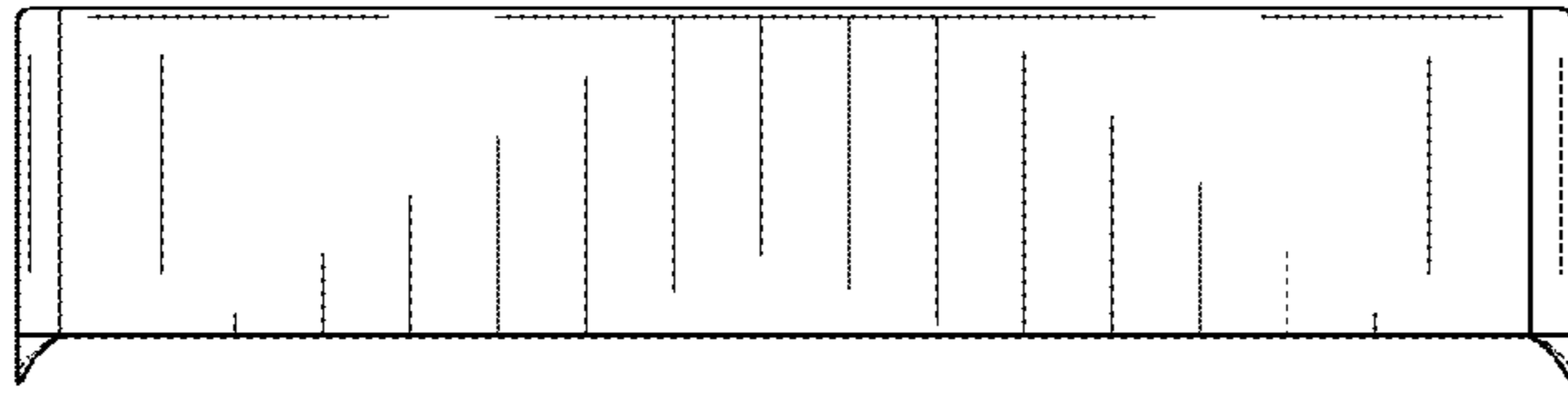

FIG. 5

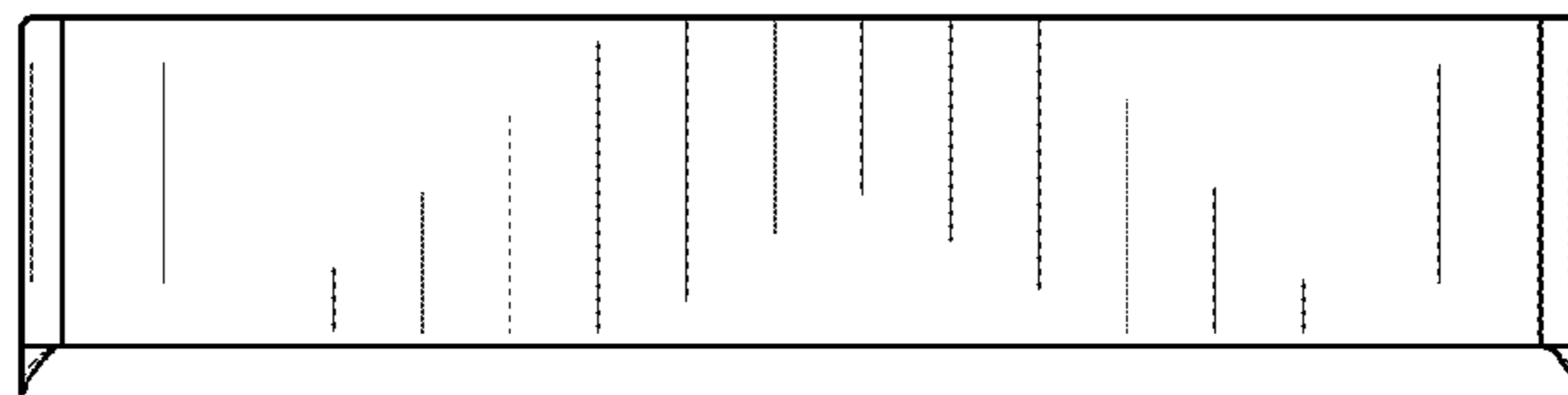

FIG. 6

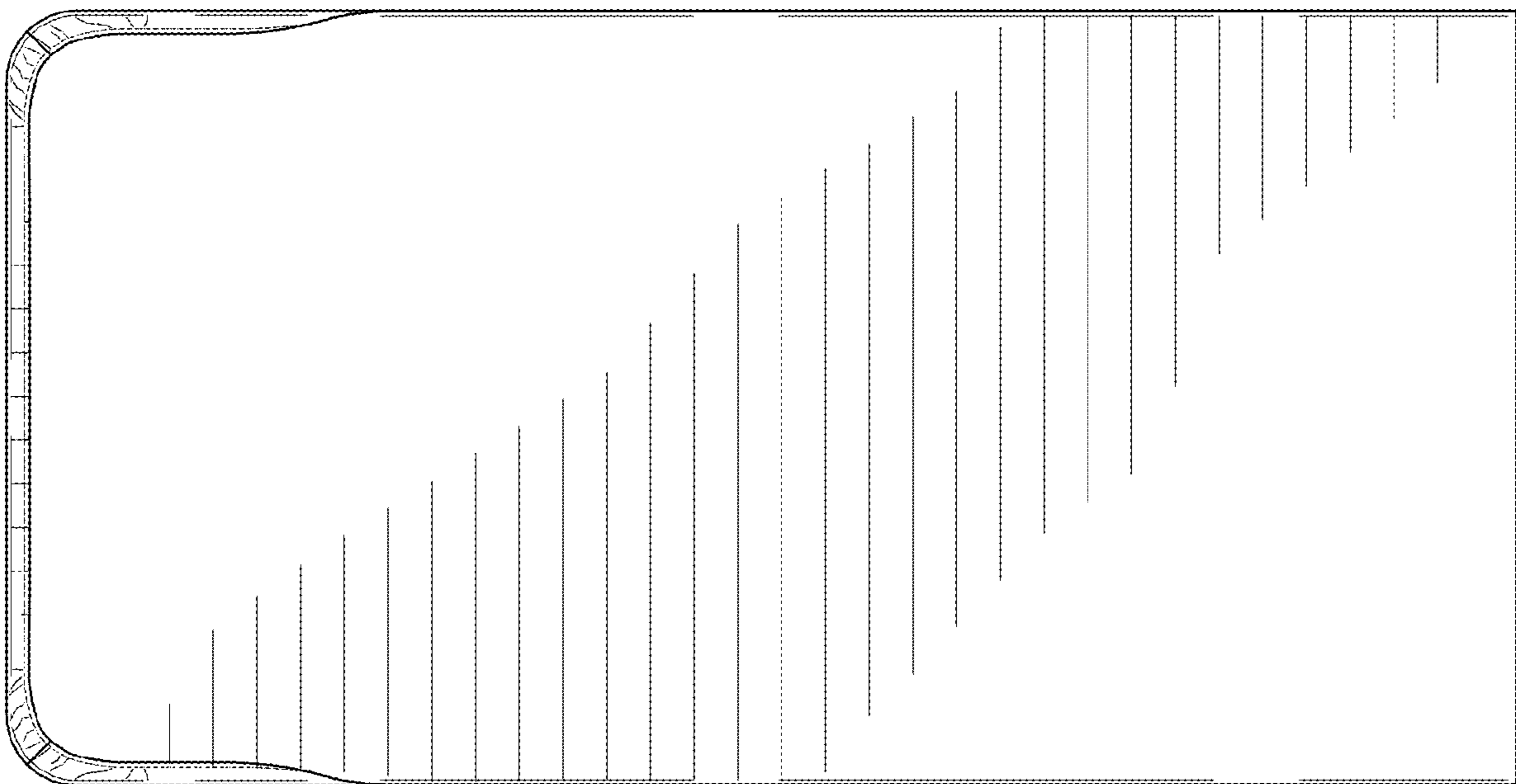

FIG. 7

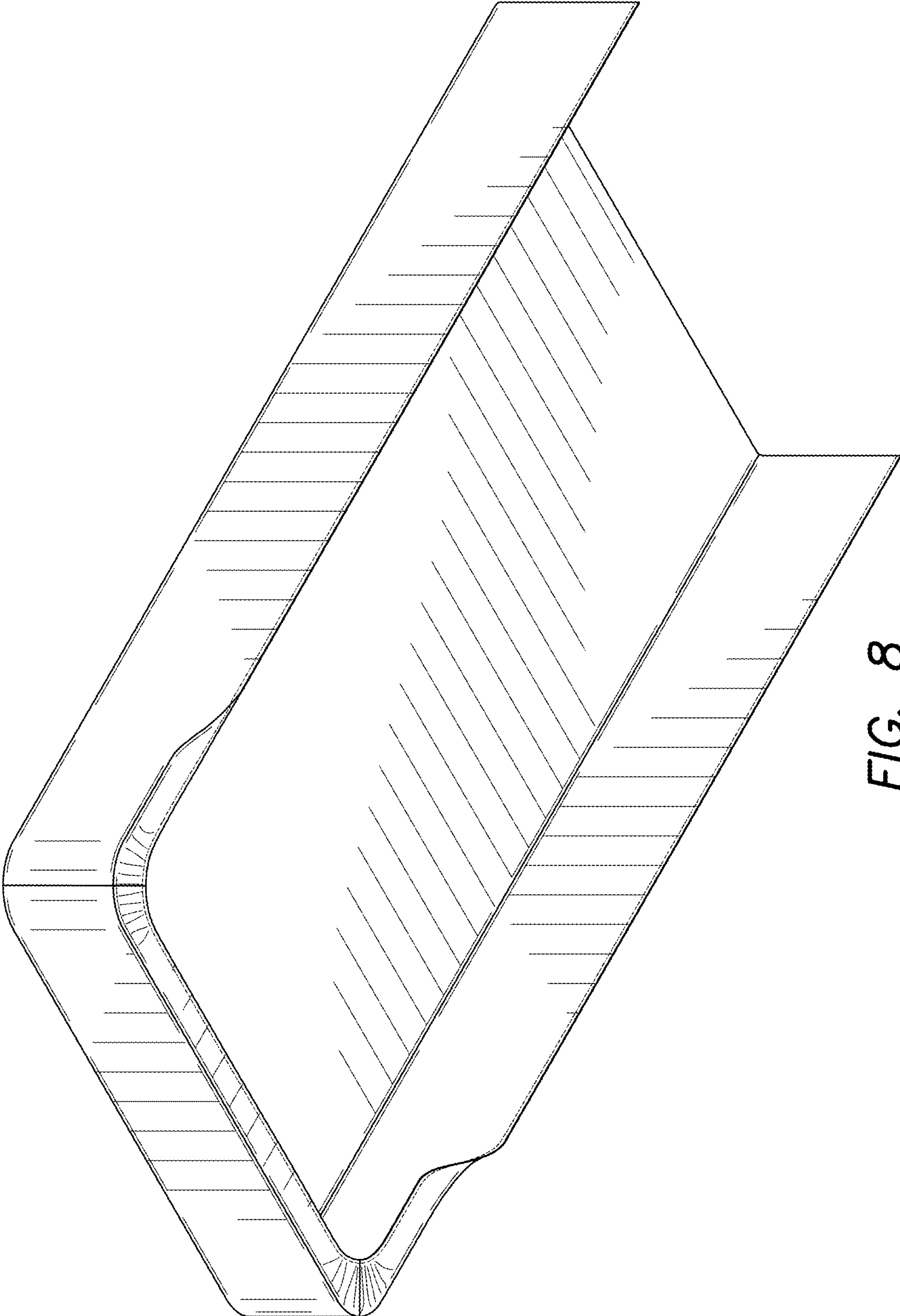

FIG. 8

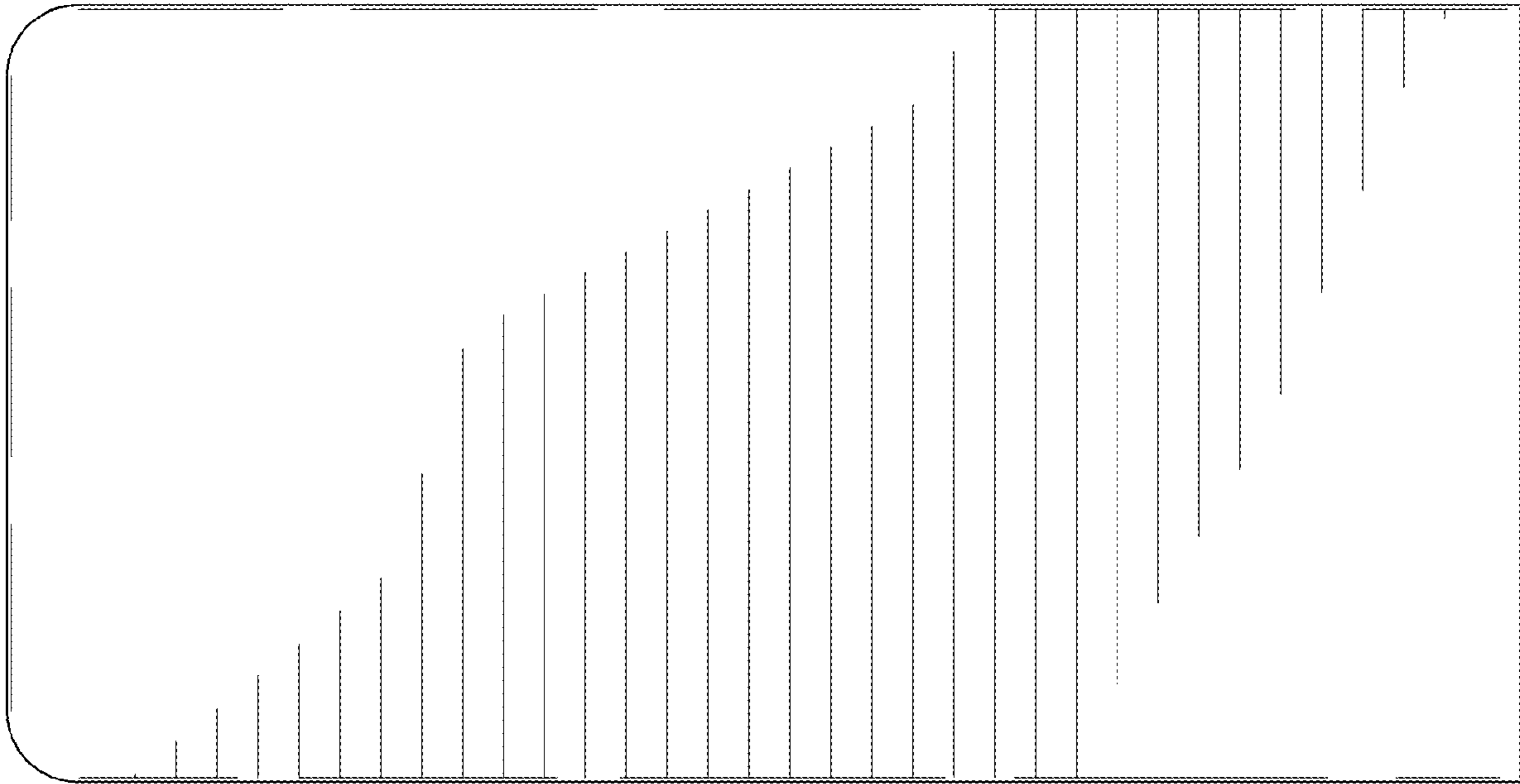

FIG. 9

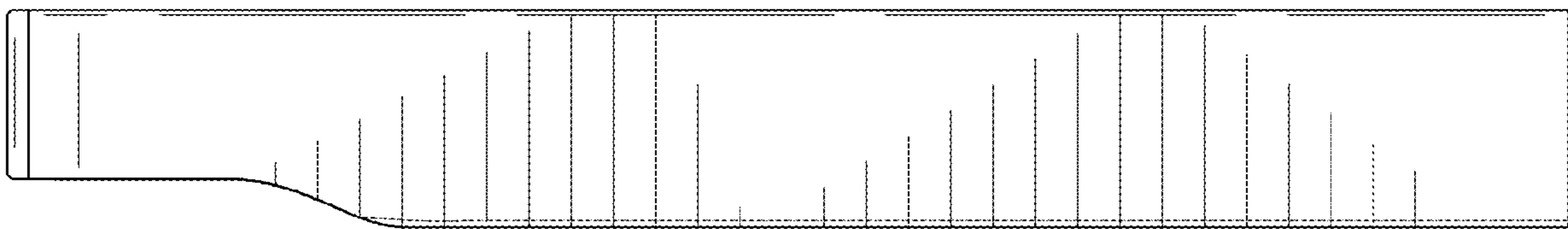

FIG. 10

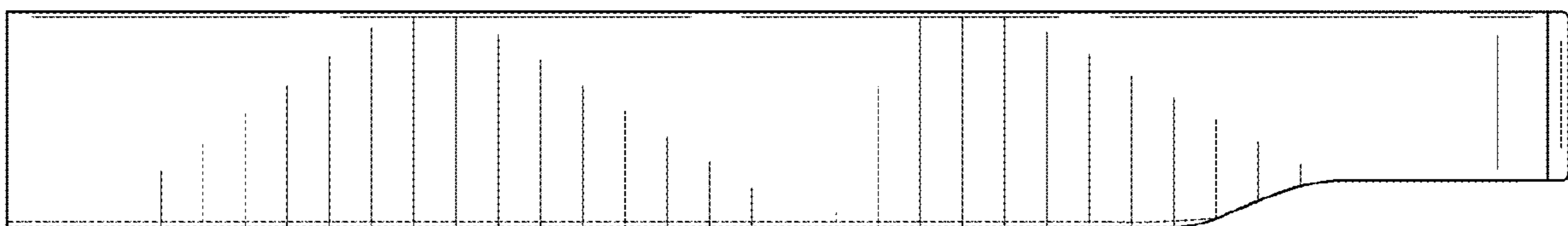

FIG. 11

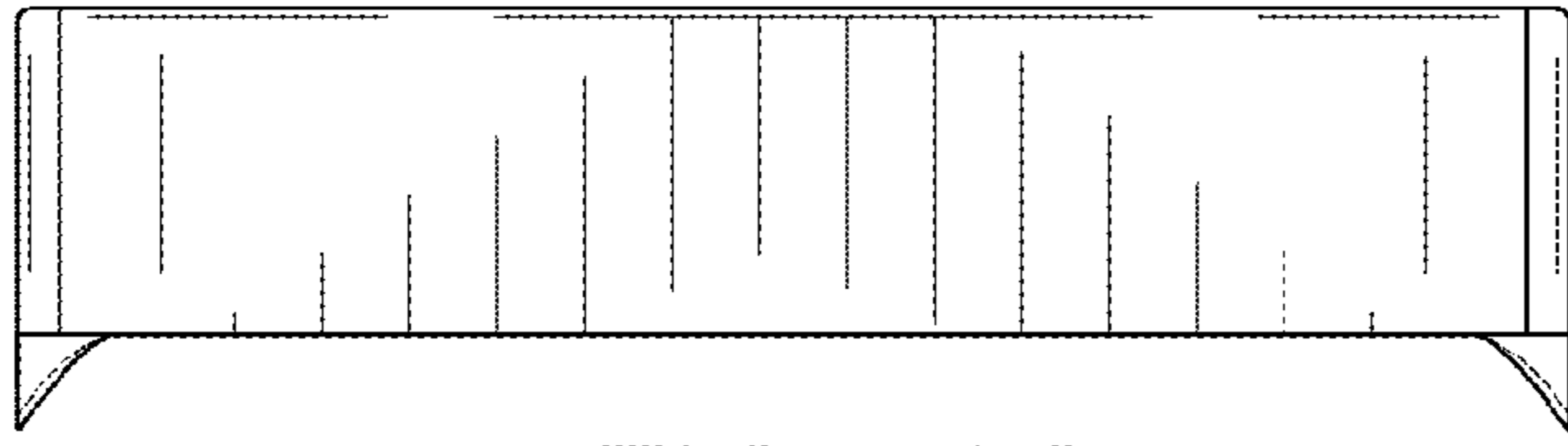

FIG. 12

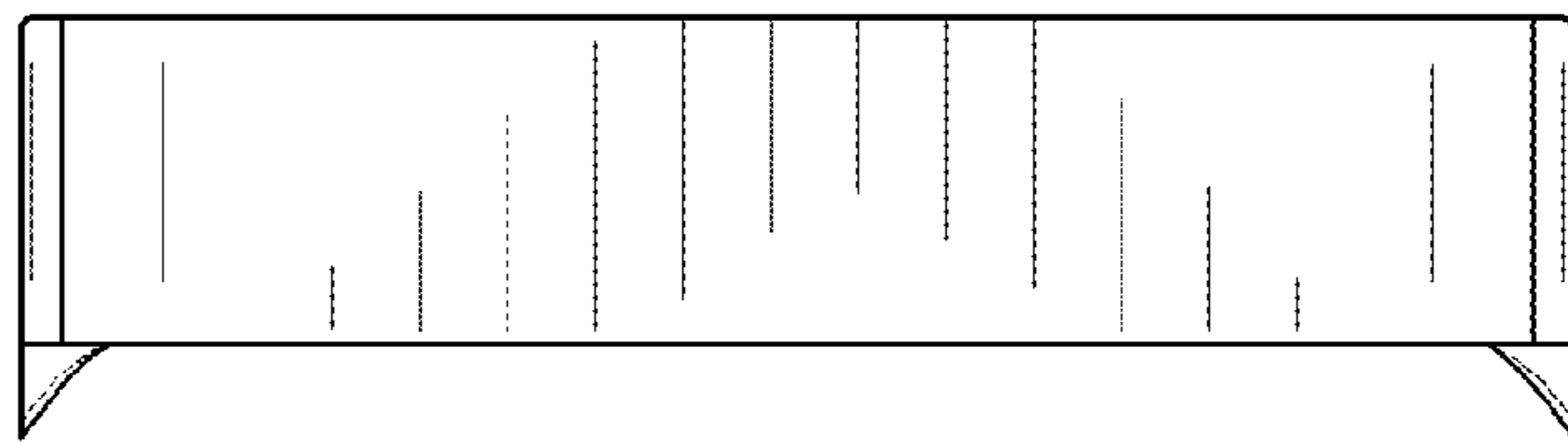

FIG. 13

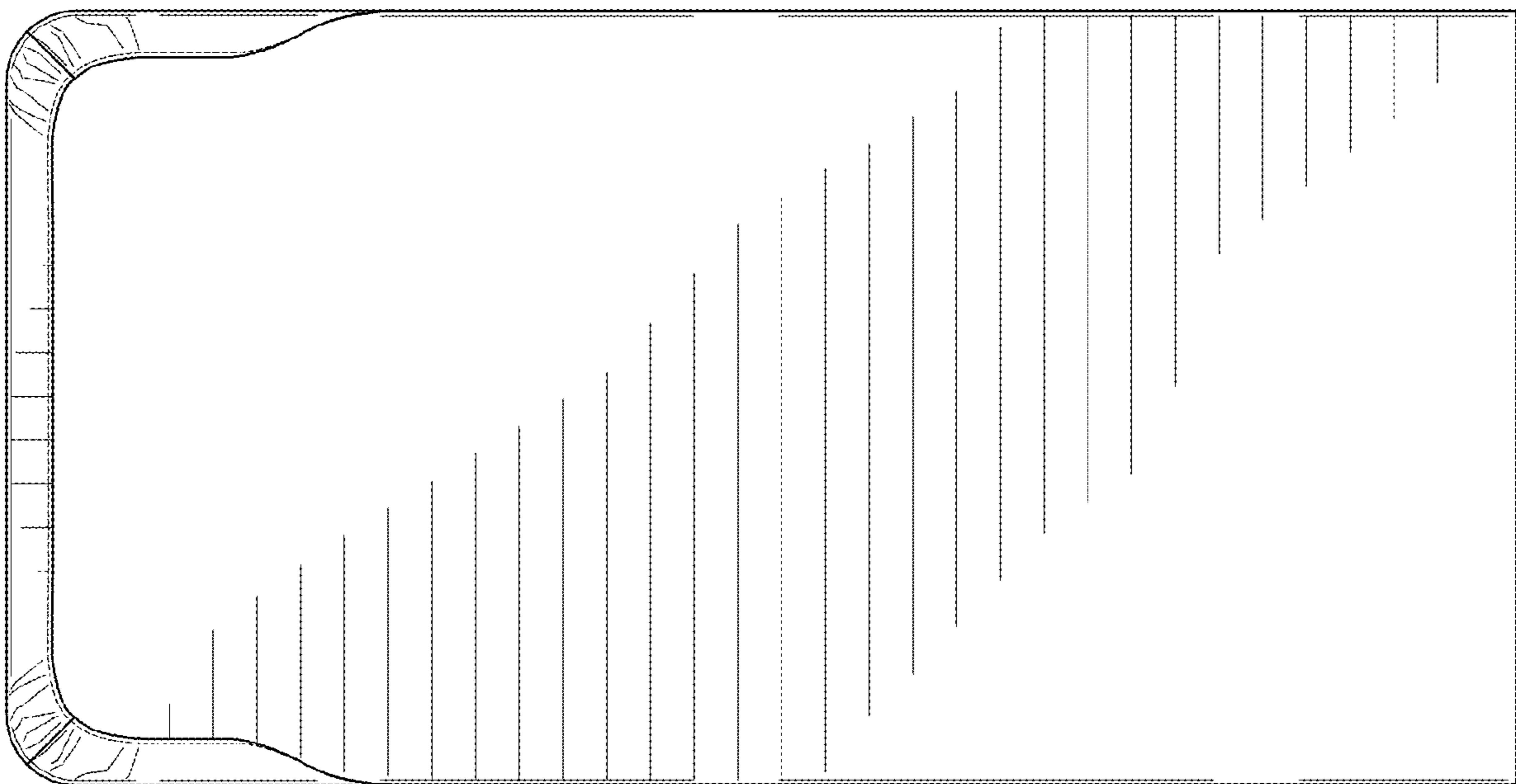

FIG. 14

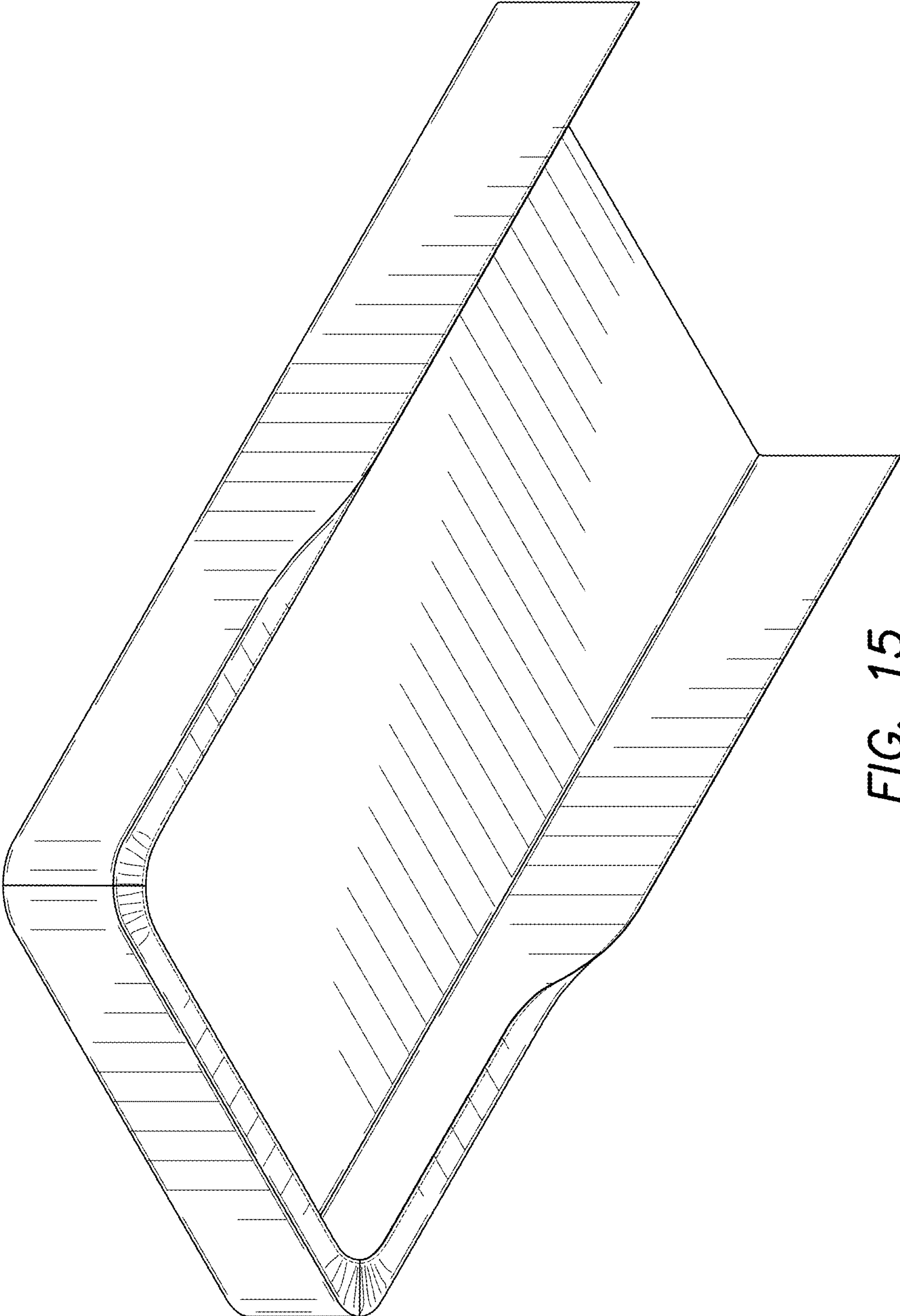

FIG. 15

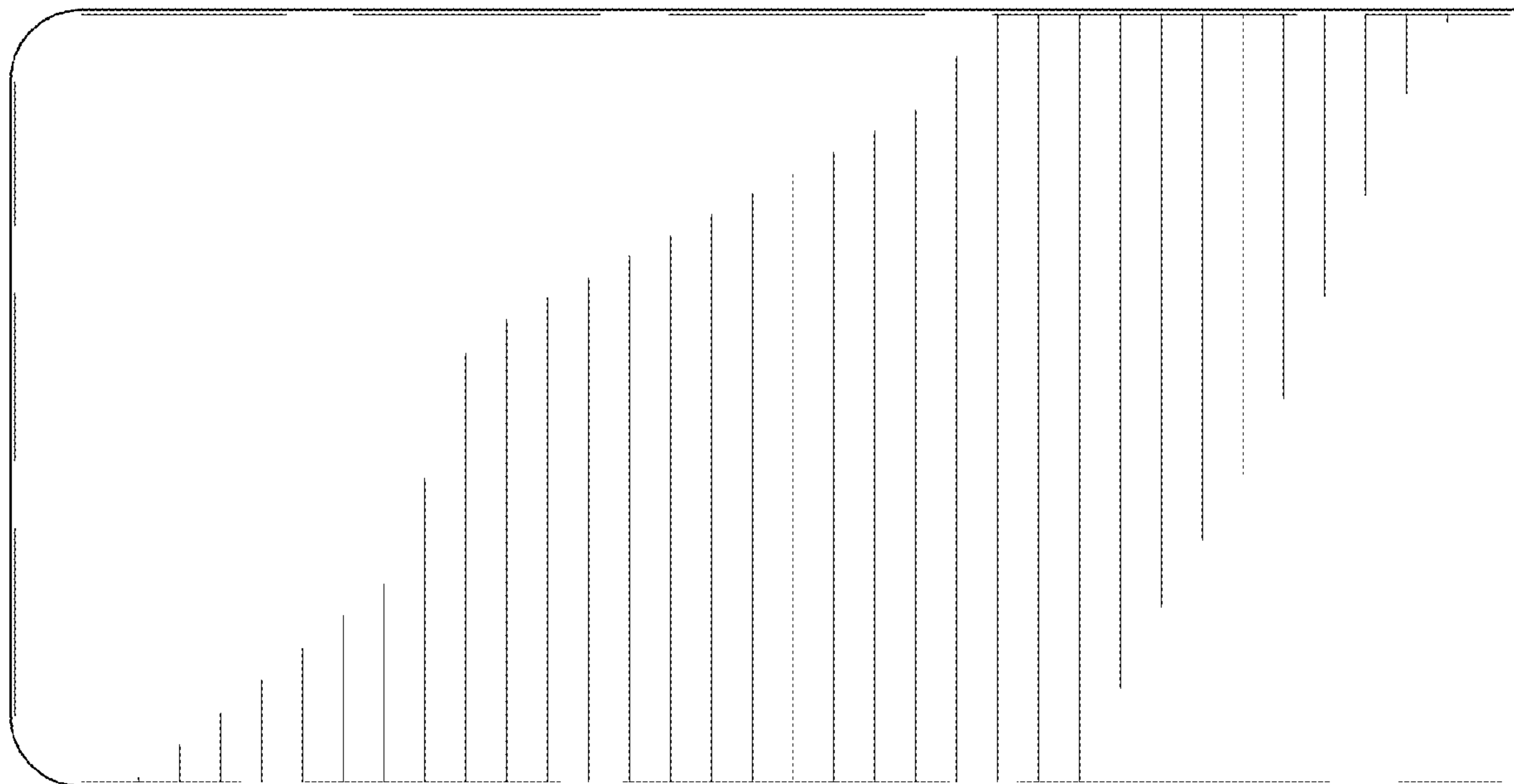

FIG. 16

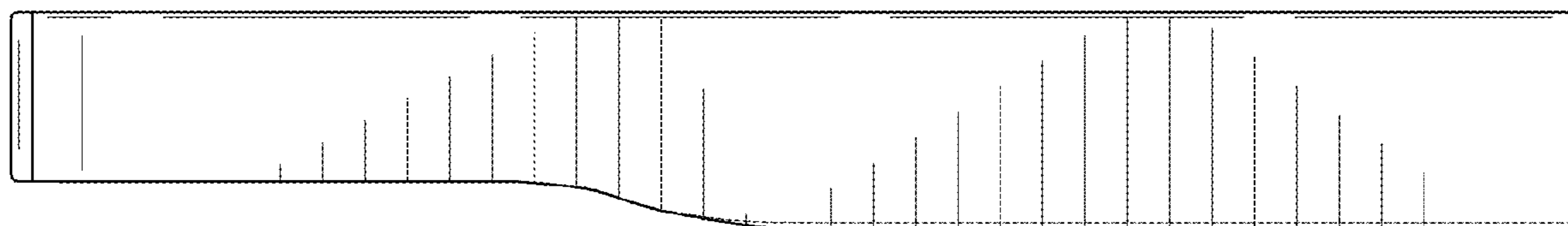

FIG. 17

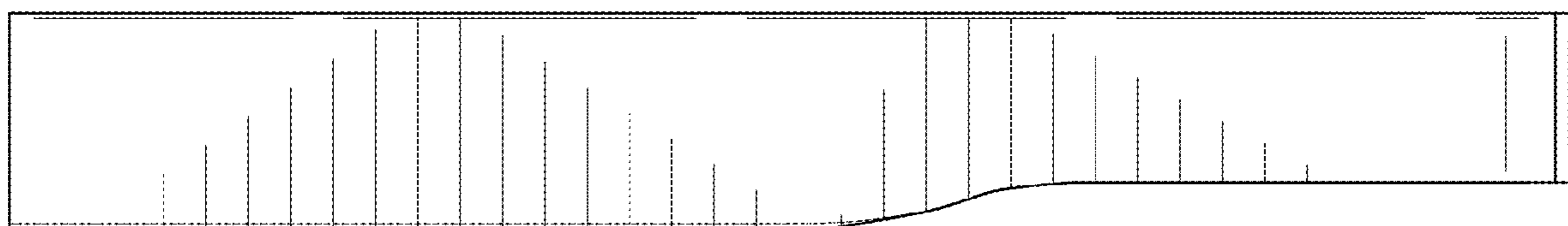

FIG. 18

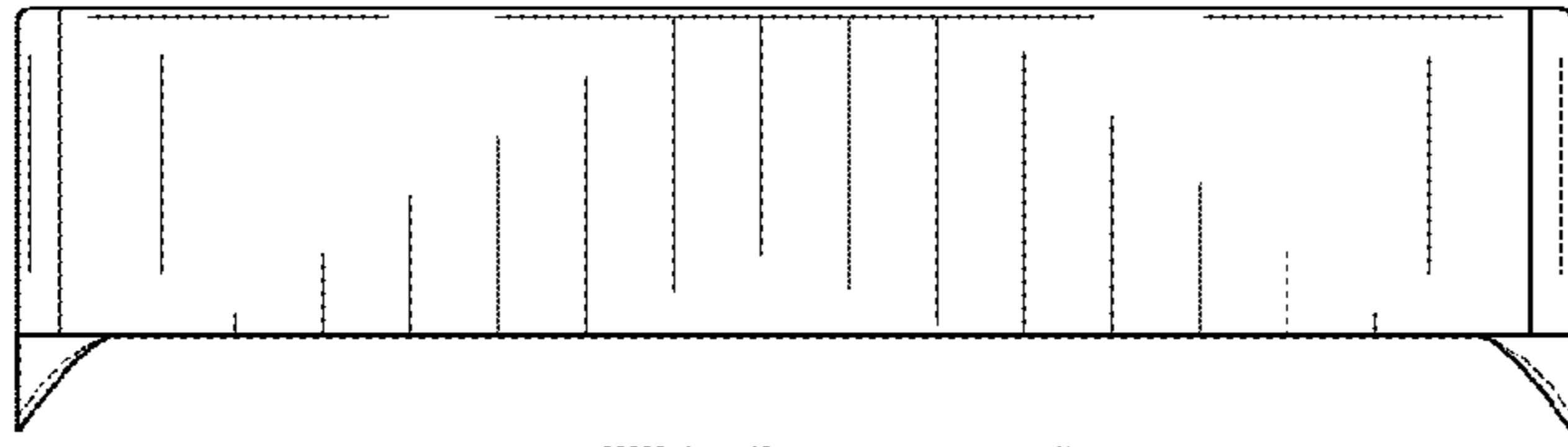

FIG. 19

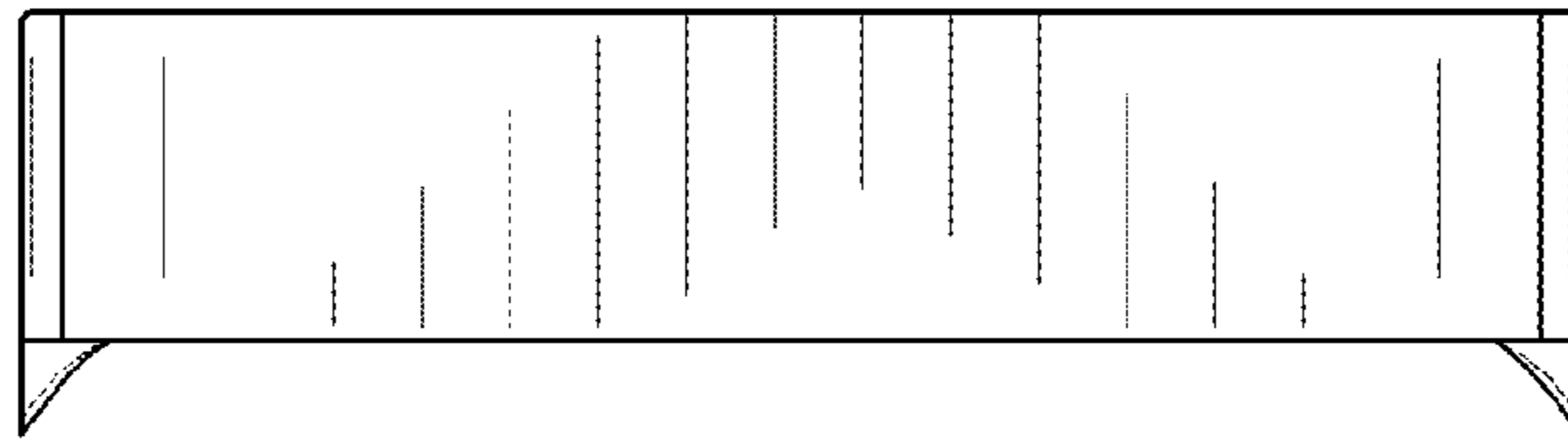

FIG. 20

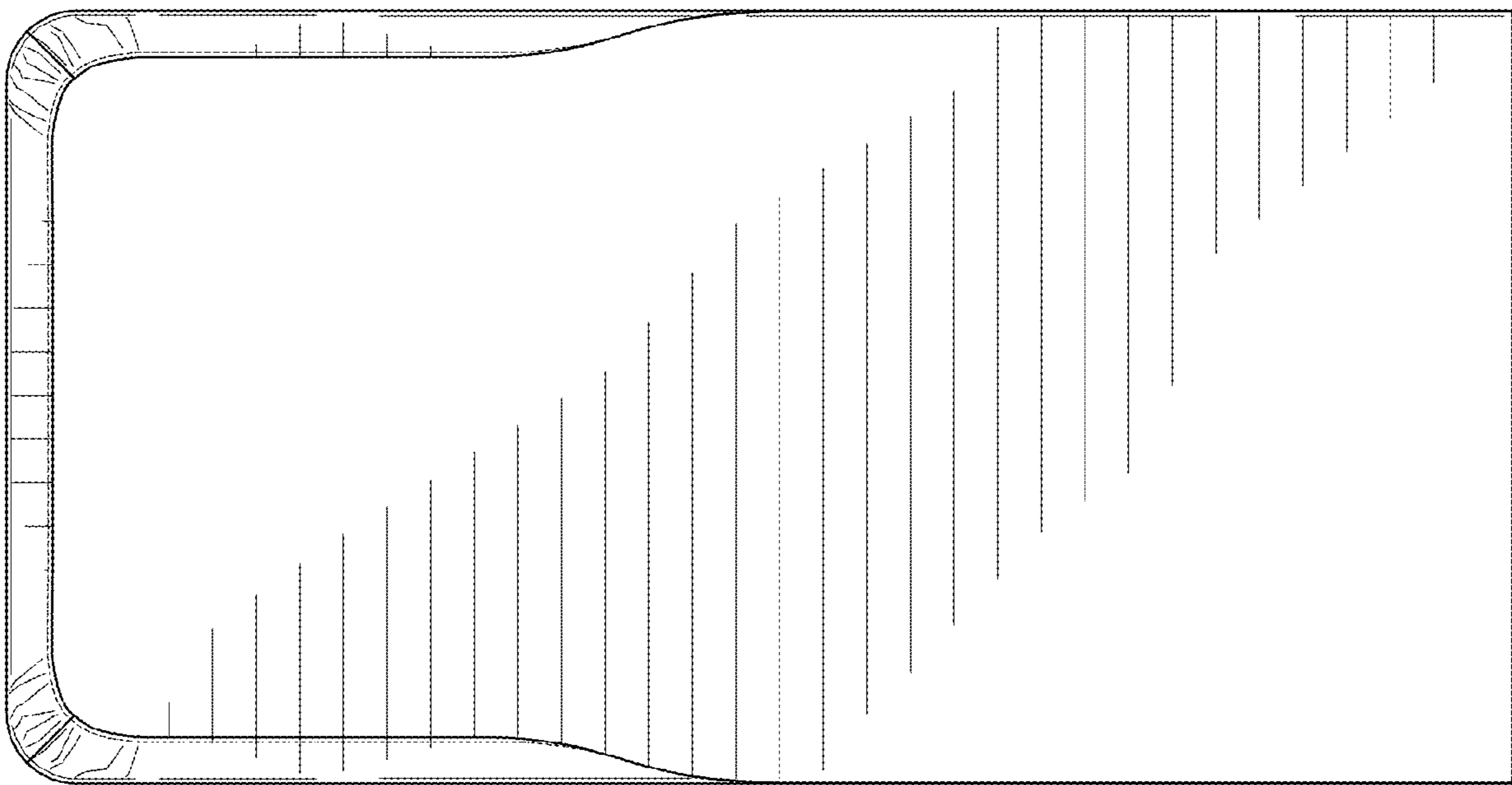

FIG. 21