



US00D907350S

(12) **United States Design Patent**
Grondin

(10) **Patent No.:** **US D907,350 S**
(45) **Date of Patent:** **** Jan. 12, 2021**

(54) **LACING ELEMENT FOR FOOTWEAR**

FOREIGN PATENT DOCUMENTS

(71) Applicant: **New Balance Athletics, Inc.**, Boston, MA (US)

CN 2220179 Y 2/1996

* cited by examiner

(72) Inventor: **Jonathan Grondin**, Waltham, MA (US)

Primary Examiner — Rashida C. Walshon

(73) Assignee: **New Balance Athletics, Inc.**, Boston, MA (US)

(74) *Attorney, Agent, or Firm* — Goodwin Procter LLP

(**) Term: **15 Years**

(57) **CLAIM**

(21) Appl. No.: **29/680,256**

The ornamental design for lacing element for footwear, as shown and described.

(22) Filed: **Feb. 14, 2019**

(51) **LOC (13) Cl.** **02-04**

(52) **U.S. Cl.**
USPC **D2/978**

(58) **Field of Classification Search**
USPC D2/896, 900, 909–911, 943, 946, 969,
D2/970, 972, 976, 978
CPC .. A43B 3/10; A43B 3/16; A43B 23/00; A43B
23/02
See application file for complete search history.

DESCRIPTION

FIG. 1 is a lateral side view of lacing element for footwear; FIG. 2 is a top perspective view thereof; FIG. 3 is an enlarged detail of lacing element for footwear of FIG. 2; FIG. 4 is a medial side view of lacing element for footwear of FIG. 1; FIG. 5 is a front view of lacing element for footwear of FIG. 1; FIG. 6 is a plan view of lacing element for footwear of FIG. 1; FIG. 7 is a rear view of lacing element for footwear of FIG. 1; and, FIG. 8 is a bottom view of lacing element for footwear of FIG. 1.

The broken lines illustrate portions of the lacing element and article of footwear that form no part of the claimed design.

(56) **References Cited**

U.S. PATENT DOCUMENTS

2,384,927	A	9/1945	Julianelli	
D386,607	S *	11/1997	Selbiger	D2/946
D461,950	S *	8/2002	Adams	D2/902
D770,748	S *	11/2016	Kuerbis	D2/972
D784,002	S *	4/2017	Cochrane	D2/973
9,763,495	B2	9/2017	Takada et al.	
D882,237	S *	4/2020	Petrenka	D2/972

1 Claim, 7 Drawing Sheets

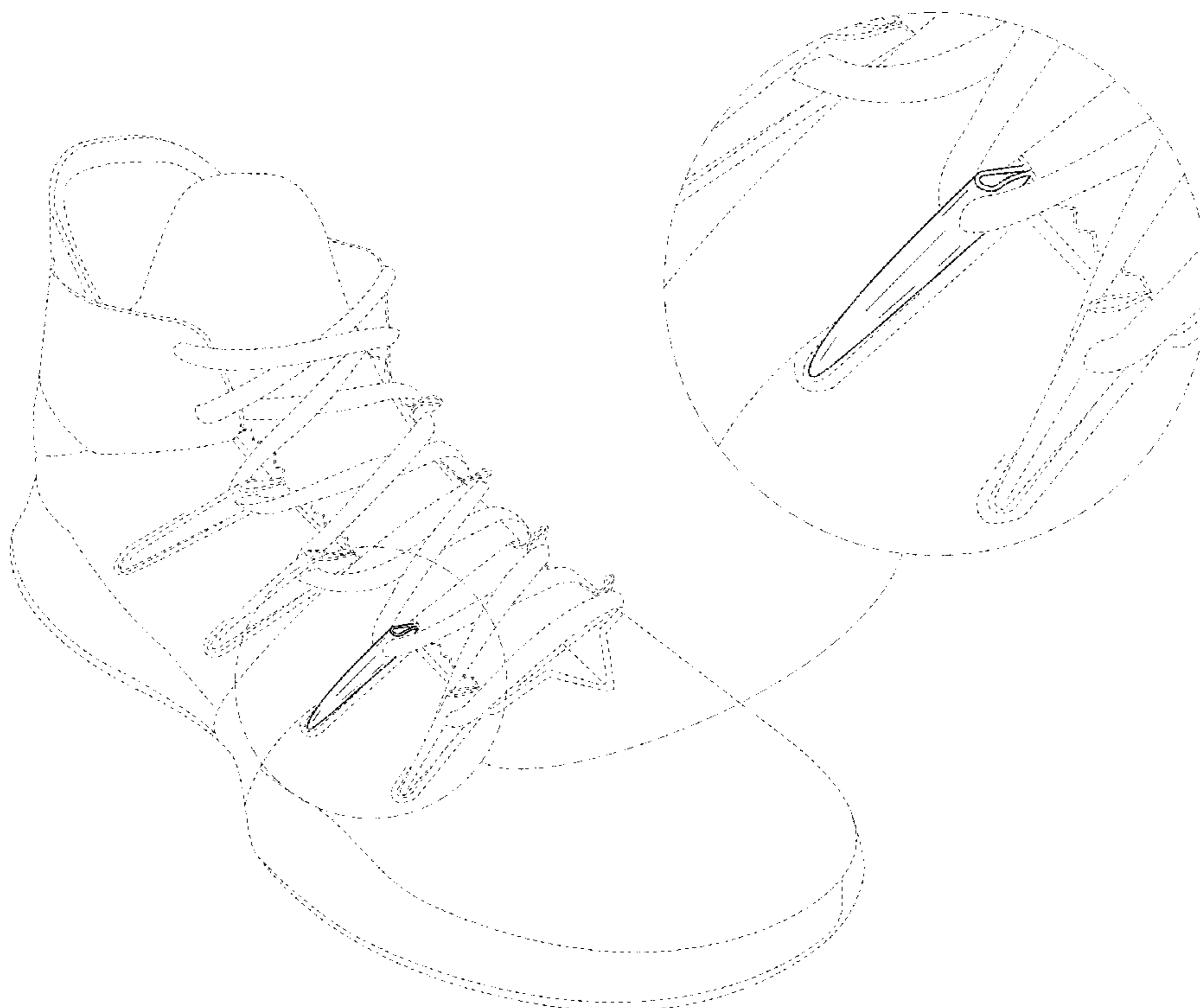



FIG. 1

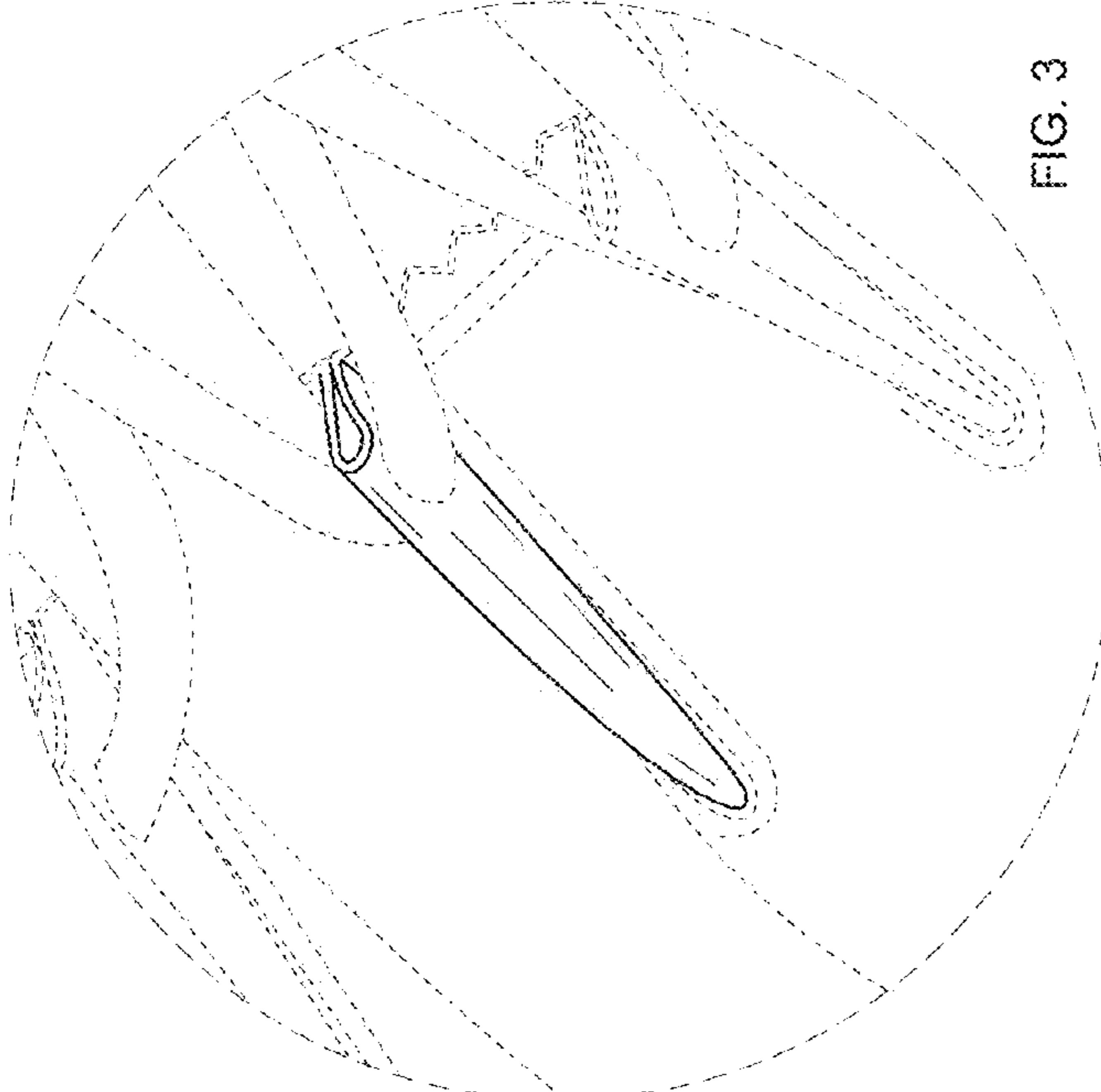

FIG. 3

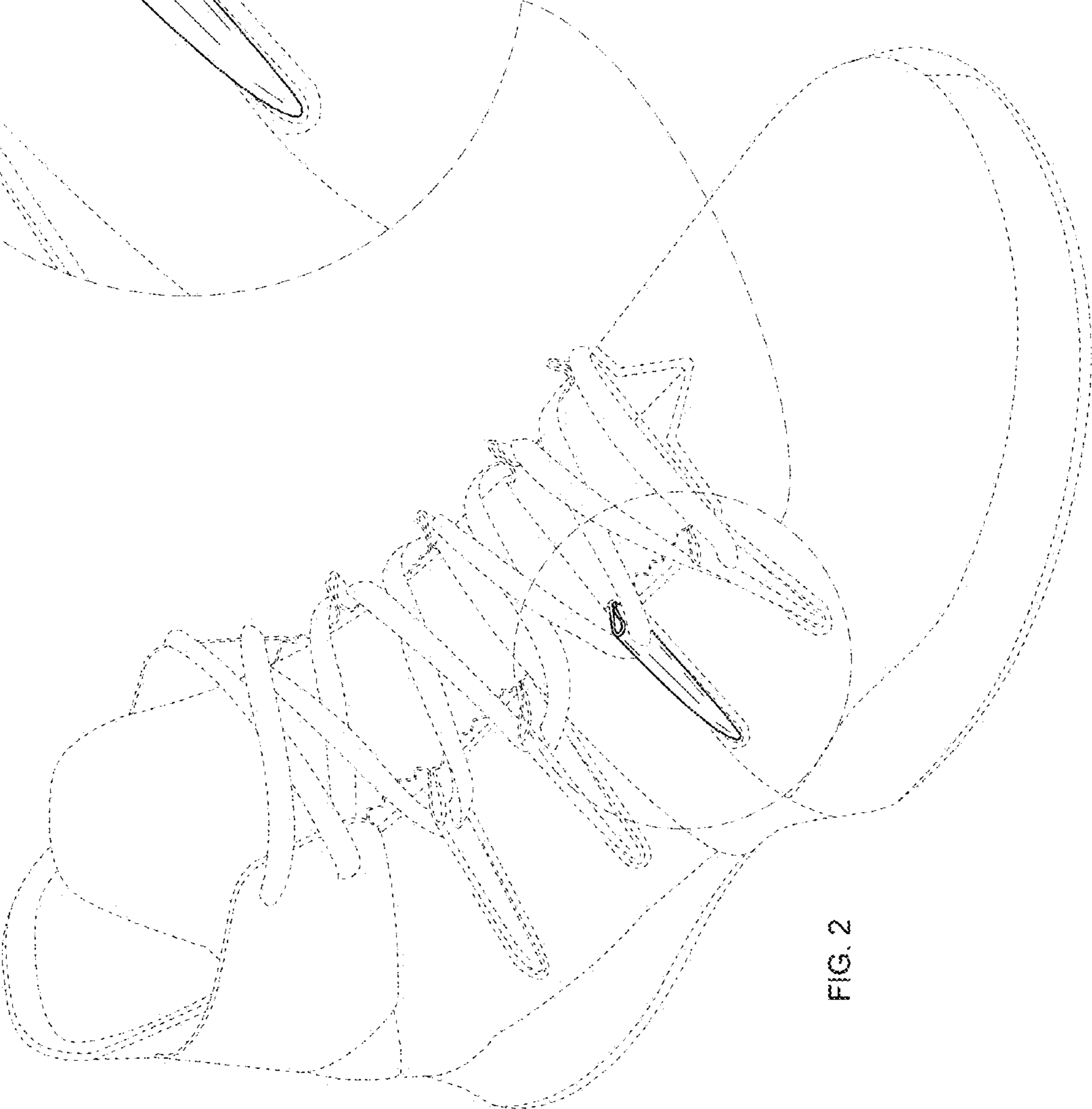

FIG. 2

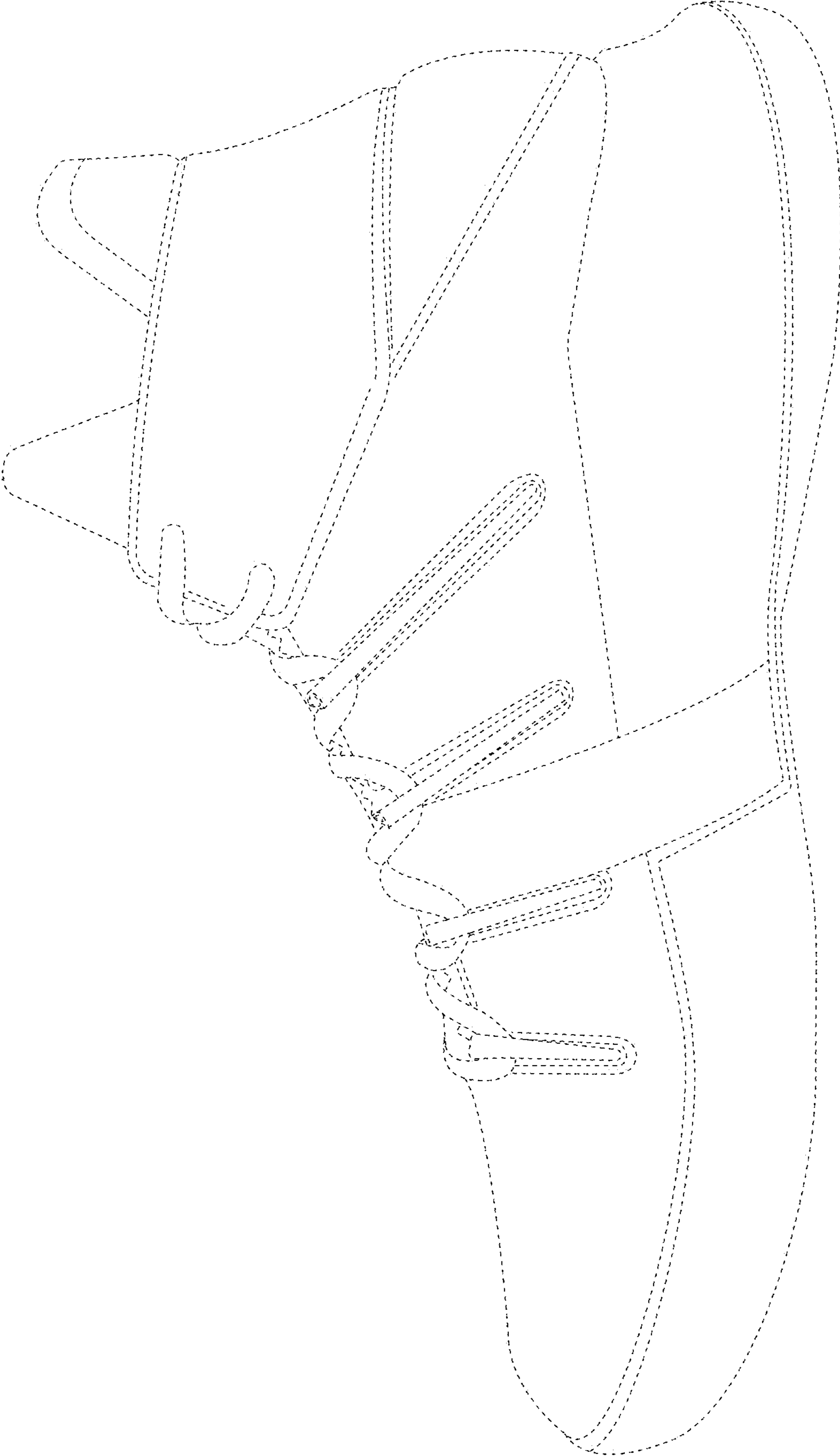

FIG. 4

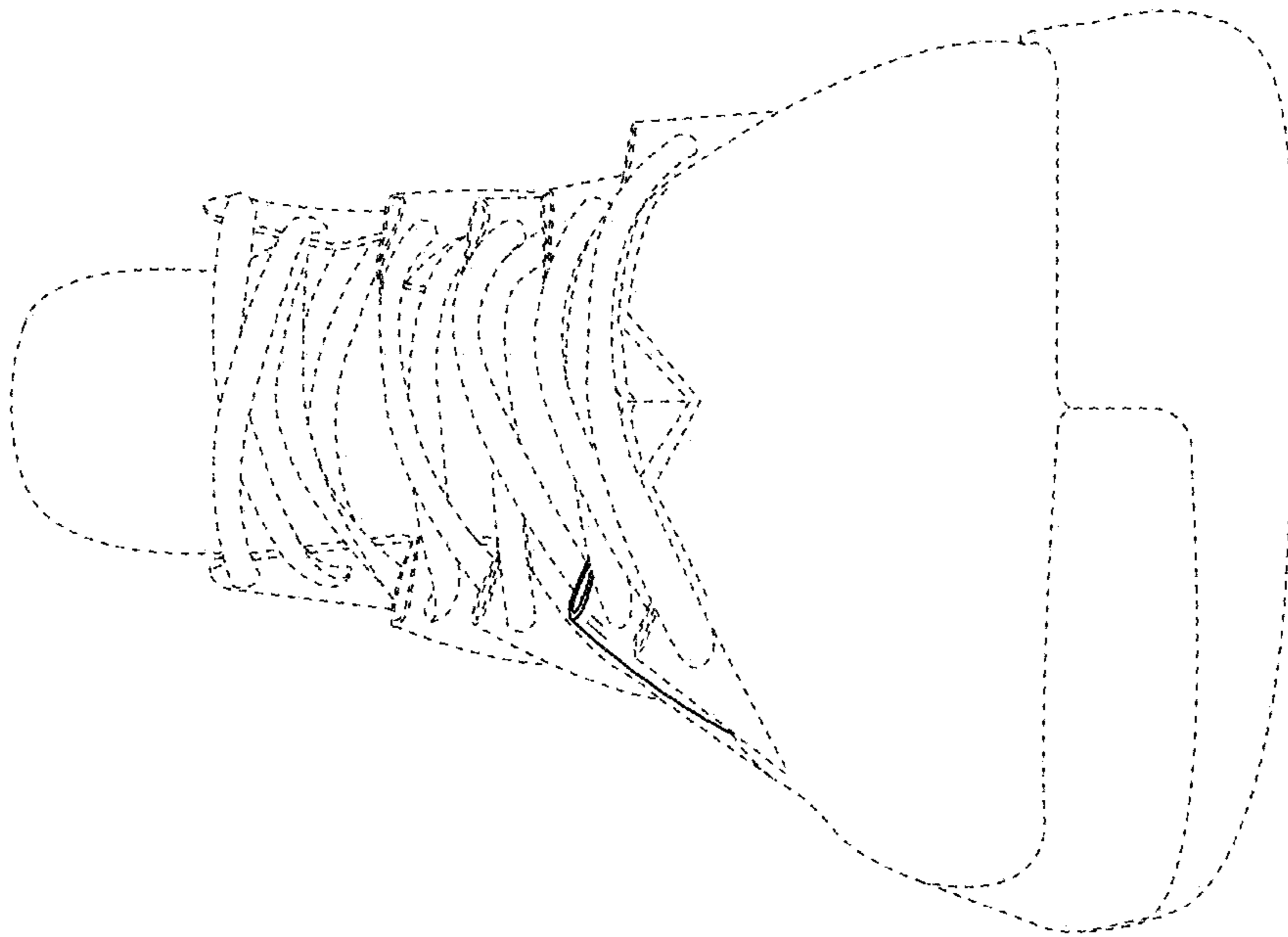

FIG. 5

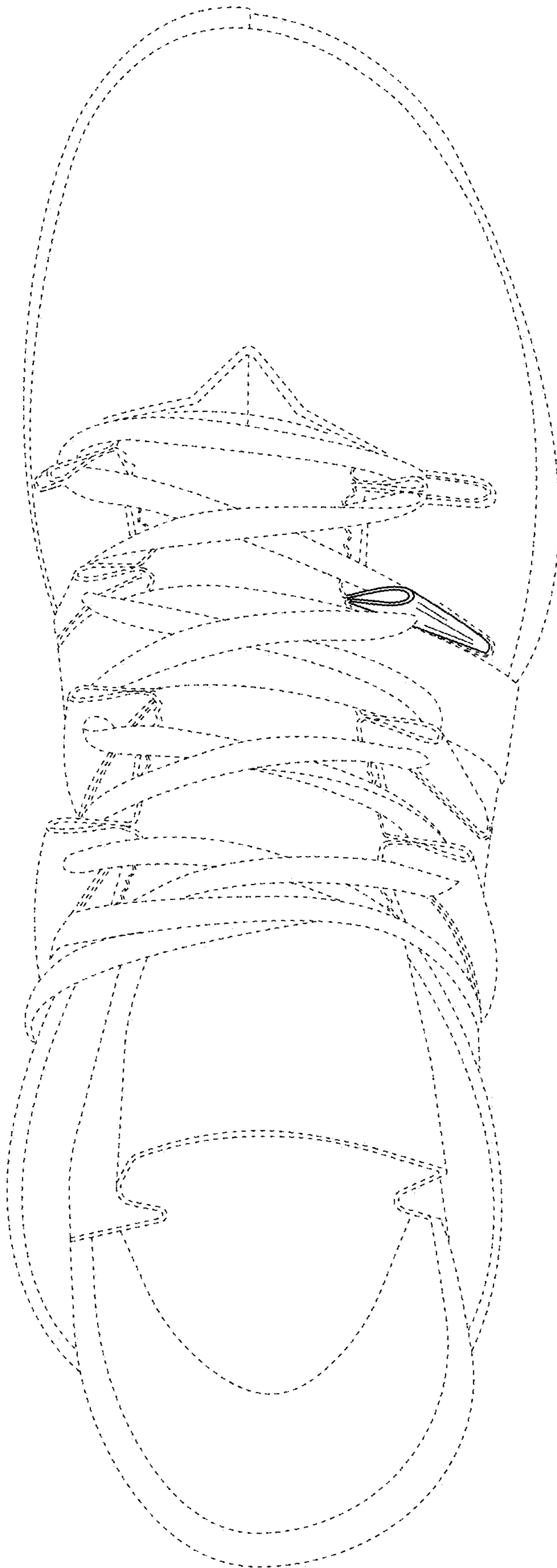

FIG. 6

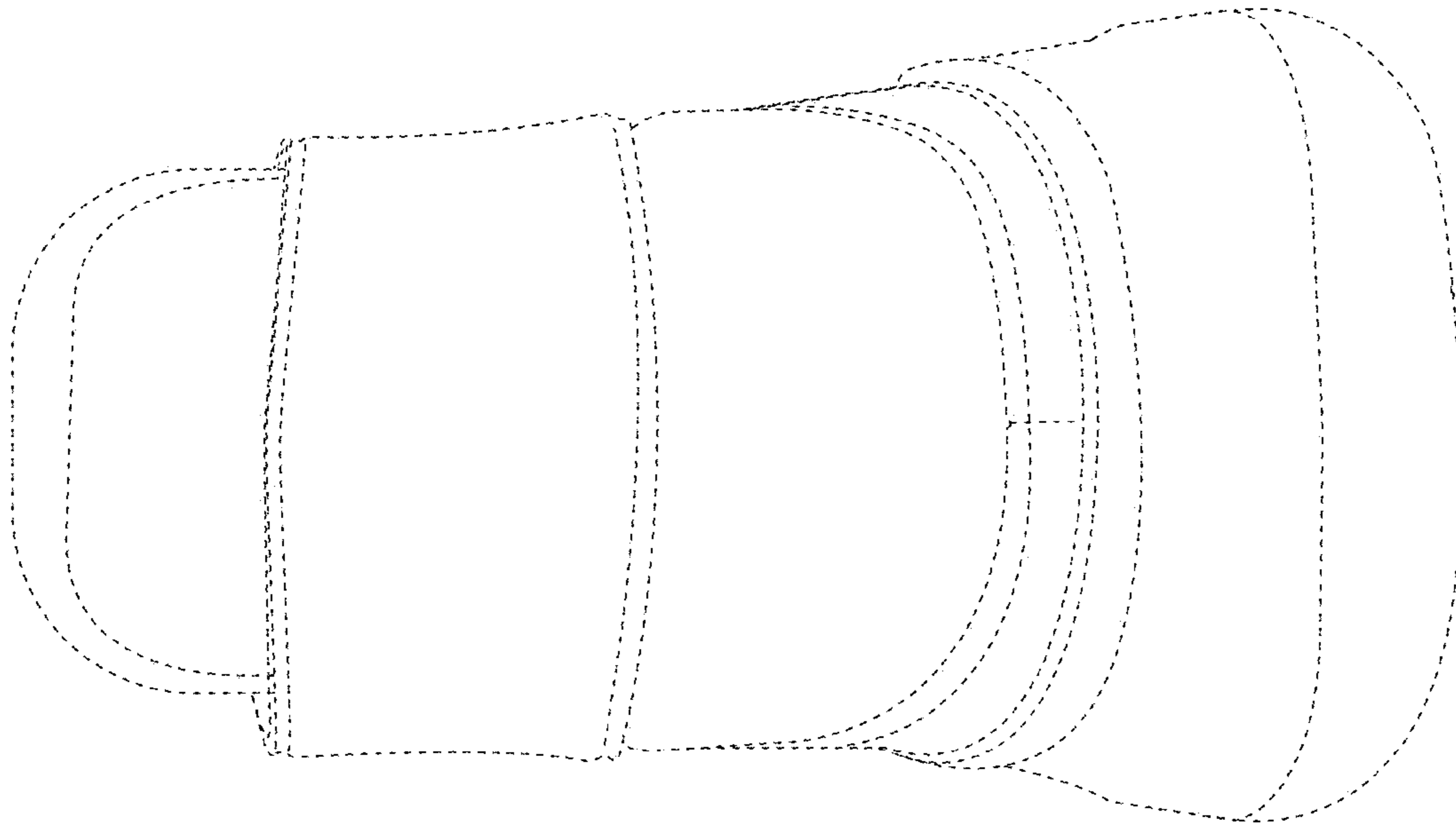

FIG. 7

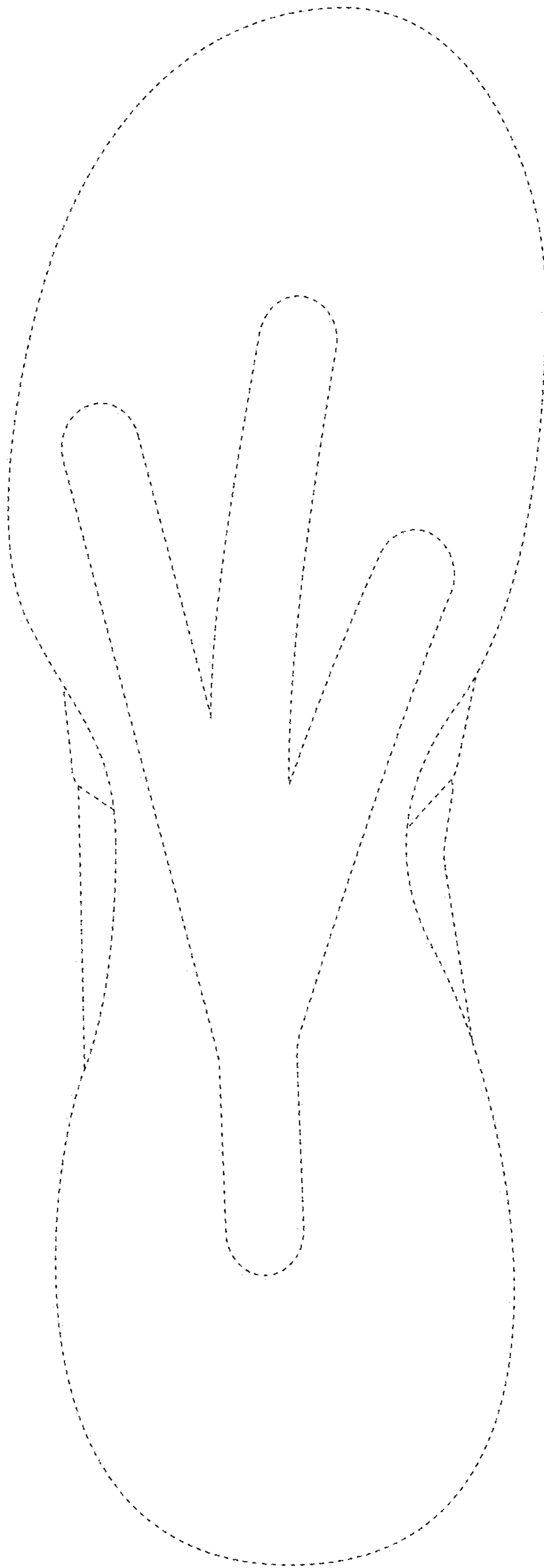

FIG. 8