



US00D907255S

(12) **United States Design Patent** (10) **Patent No.:** **US D907,255 S**  
**Barnds et al.** (45) **Date of Patent:** **\*\* Jan. 5, 2021**

(54) **POLYMER-BASED FLOORING**  
(71) Applicant: **CPG International LLC**, Scranton, PA (US)  
(72) Inventors: **Patrick Michael Barnds**, Birmingham, MI (US); **Jason Andrew Davoll**, Chicago, IL (US)  
(73) Assignee: **CPG International LLC**, Scranton, PA (US)  
(\*\*) Term: **15 Years**  
(21) Appl. No.: **29/679,754**  
(22) Filed: **Feb. 8, 2019**  
(51) **LOC (13) Cl.** ..... **25-01**  
(52) **U.S. Cl.**  
USPC ..... **D25/138**  
(58) **Field of Classification Search**  
USPC ..... D25/138  
CPC ..... E04F 15/02044; E04F 15/02194; E04F 15/022; E04F 15/02405; E04F 15/02417; E04F 15/04; E04F 15/045; E04F 15/046; E04F 15/048; E04F 15/06; E04F 15/12  
See application file for complete search history.

8,800,245 B1 \* 8/2014 Pien ..... B32B 3/30  
52/747.11  
D715,460 S \* 10/2014 Smith ..... D25/138  
D751,223 S \* 3/2016 Muxlow ..... D25/138  
D802,169 S \* 11/2017 Lee ..... D25/138  
9,944,050 B2 \* 4/2018 Kanao ..... B32B 9/04  
10,035,358 B2 \* 7/2018 Pervan ..... B41J 3/407  
10,174,509 B2 \* 1/2019 Hayes ..... B32B 5/028  
10,214,914 B2 \* 2/2019 Bachelder ..... E04F 15/02161  
D857,251 S \* 8/2019 Mussini ..... D25/160

\* cited by examiner

*Primary Examiner* — Doris Clark

(74) *Attorney, Agent, or Firm* — Shook, Hardy & Bacon L.L.P

(57) **CLAIM**

The ornamental design for a polymer-based flooring, as shown and described.

**DESCRIPTION**

FIG. 1 is a perspective view of a polymer-based flooring showing our design;  
FIG. 2 is a top view thereof;  
FIG. 3 is a bottom view thereof;  
FIG. 4 is a first side view thereof;  
FIG. 5 is a second side view thereof;  
FIG. 6 is a cross section view taken along lines 6-6 of FIG. 2;  
FIG. 7 is a front view thereof; and,  
FIG. 8 is a back view thereof.

The even-length broken lines are directed to environment, represent unclaimed subject matter, and form no part of the claimed design.

The long-and-short broken lines form an unclaimed boundary, and form no part of the claim.

**1 Claim, 5 Drawing Sheets**

(56) **References Cited**

U.S. PATENT DOCUMENTS

D387,439 S \* 12/1997 Ormiston ..... D25/138  
D482,140 S \* 11/2003 Hughes ..... D25/121  
D598,576 S \* 8/2009 Henriquez ..... D25/138  
7,897,005 B2 \* 3/2011 Knauseder ..... C09J 5/00  
156/304.5  
D642,287 S \* 7/2011 Poland ..... D25/119  
D654,599 S \* 2/2012 Cupec ..... D25/138  
D667,965 S \* 9/2012 Tuan ..... D25/138

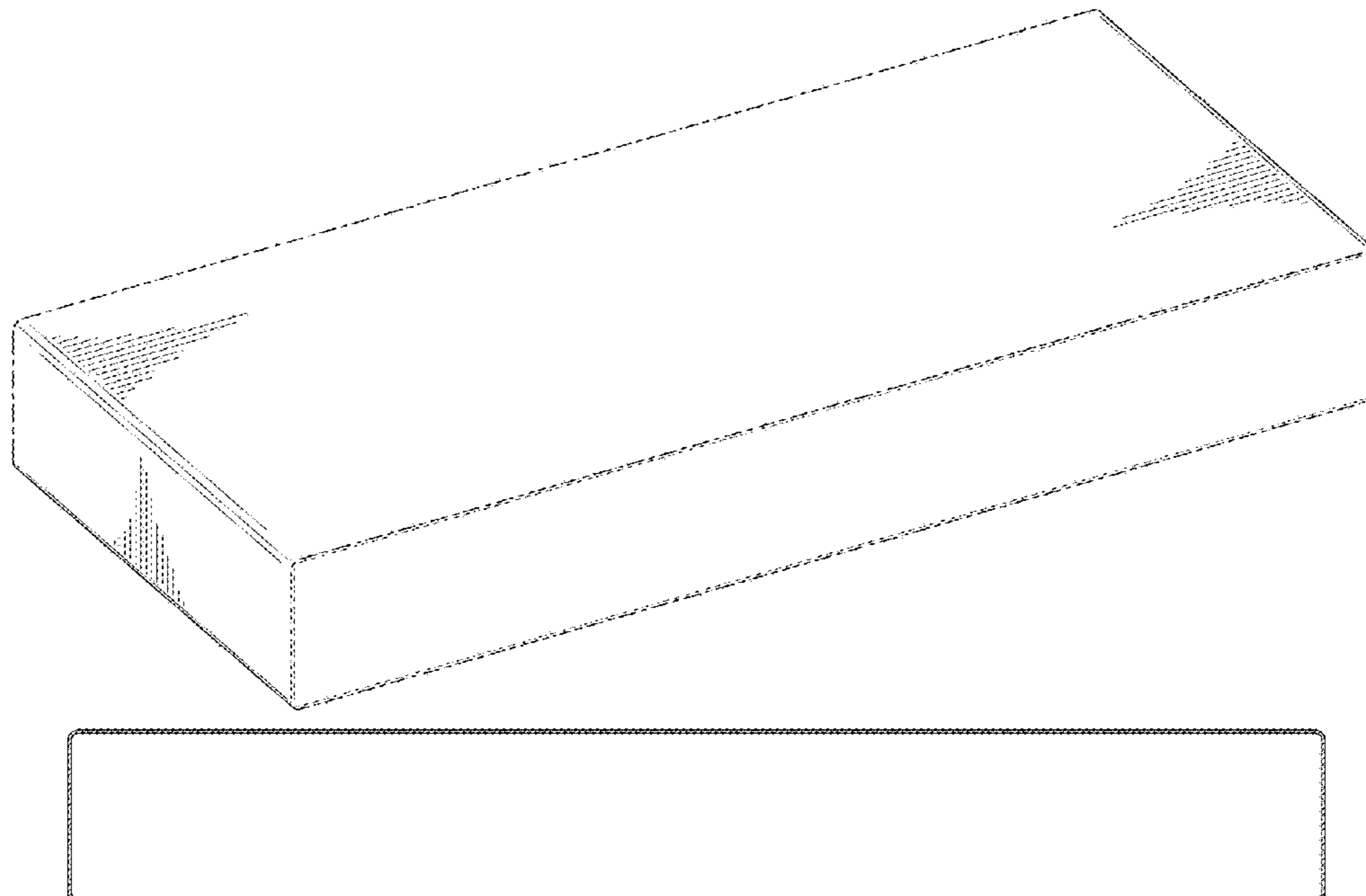



FIG. 1

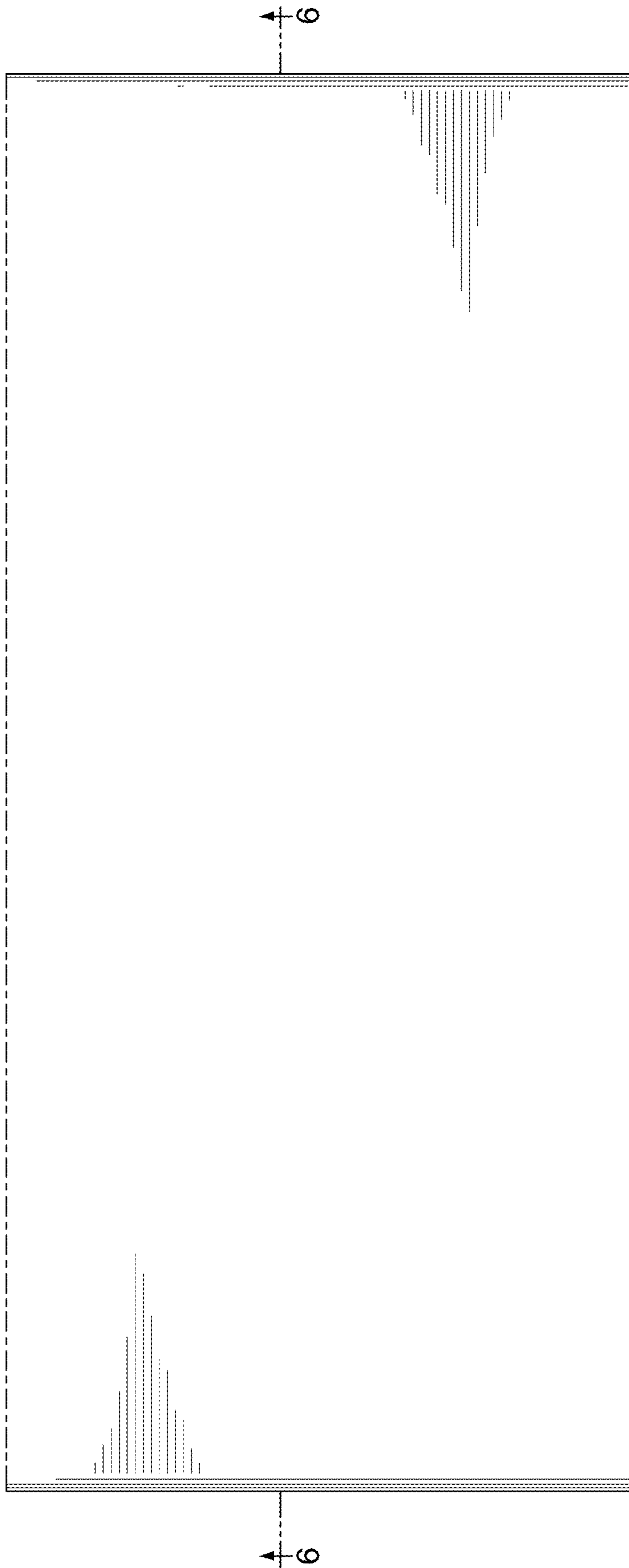

FIG. 2

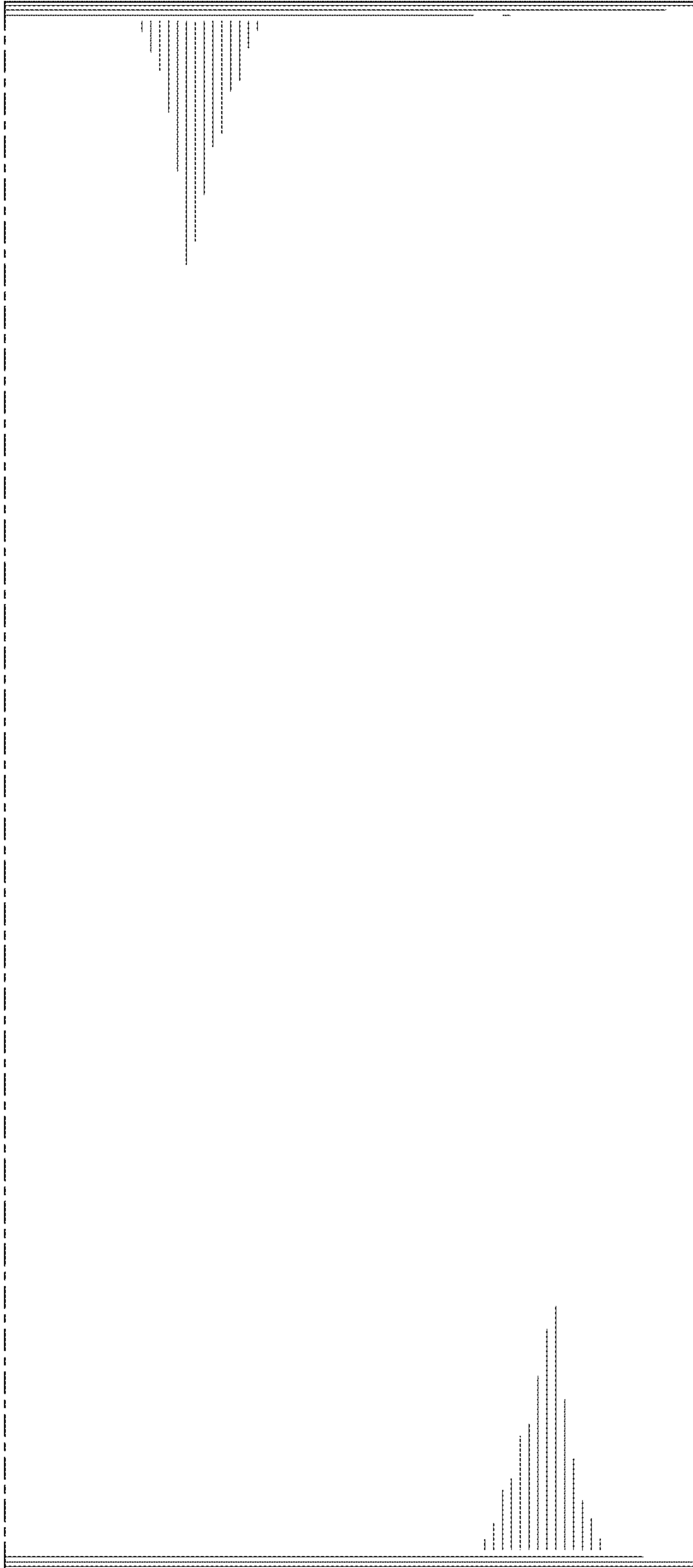

FIG. 3

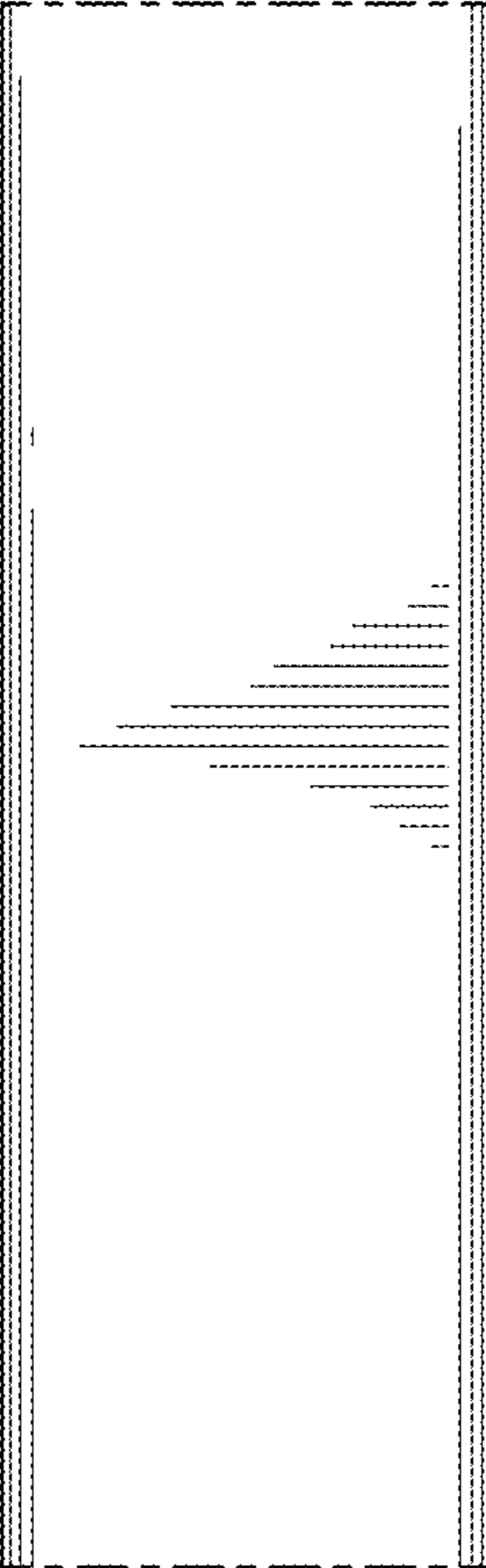

FIG. 4

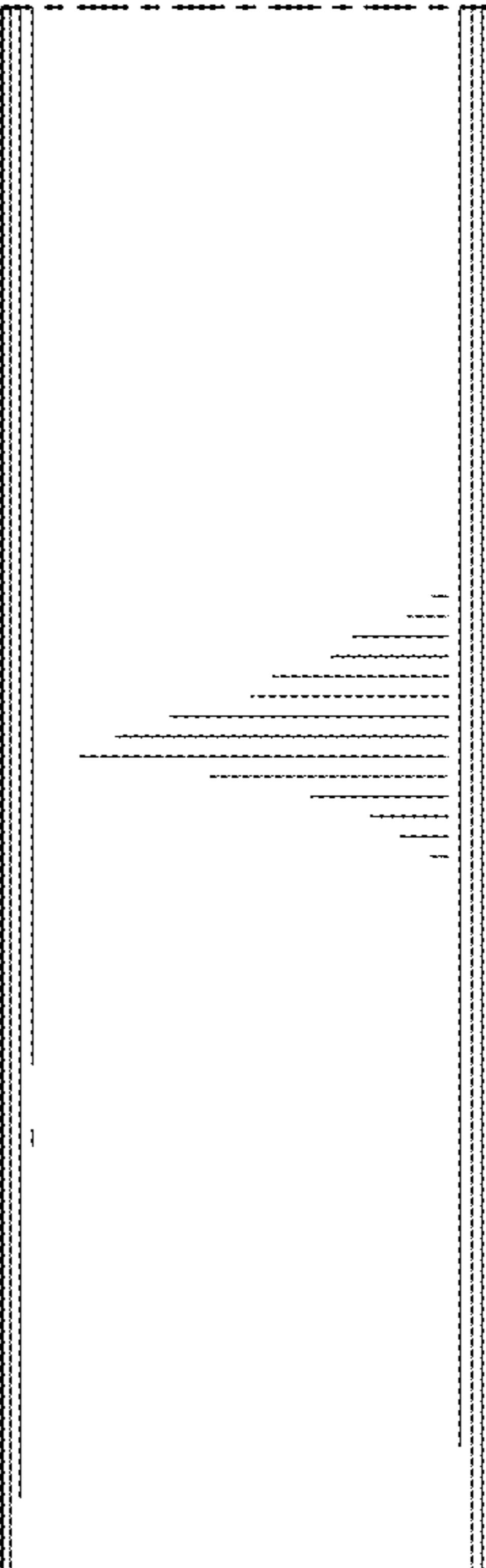

FIG. 5

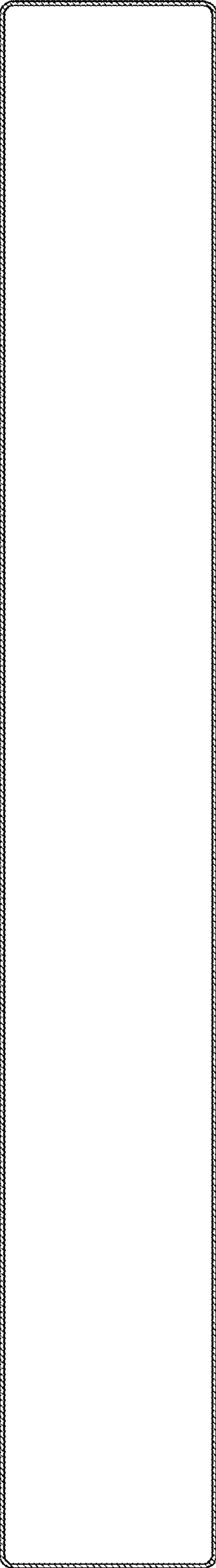

FIG. 6

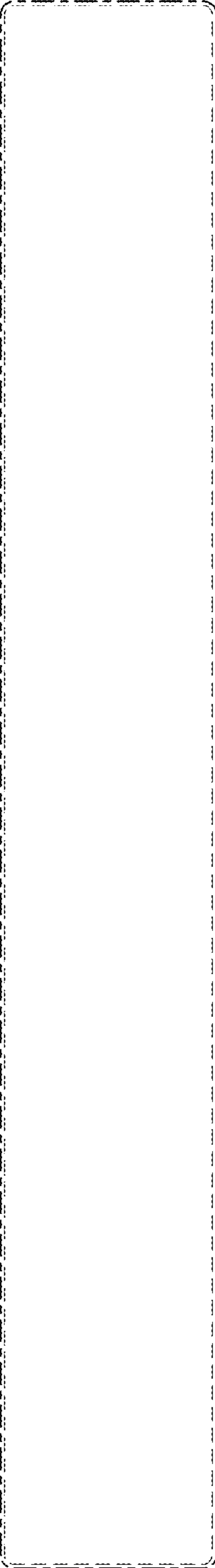

FIG. 7



FIG. 8