



US00D907125S

(12) **United States Design Patent** (10) **Patent No.:** **US D907,125 S**
DeMarco et al. (45) **Date of Patent:** **** *Jan. 5, 2021**

(54) **GAMING MACHINE**

Primary Examiner — Ryan Harvey

(71) Applicant: **ARISTOCRAT TECHNOLOGIES AUSTRALIA PTY LIMITED**, North Ryde (AU)

(74) *Attorney, Agent, or Firm* — Armstrong Teasdale LLP

(72) Inventors: **Dominic J. DeMarco**, Round Rock, TX (US); **Bruce Edward Urban**, Las Vegas, NV (US); **James Franklin Stair**, Las Vegas, NV (US); **Ariel David Turgel**, San Francisco, CA (US); **Daniel Harden**, Palo Alto, CA (US); **Alexander Abele**, Aalen (DE)

(57) **CLAIM**

We claim the ornamental design for a gaming machine, as shown and described.

(73) Assignee: **Aristocrat Technologies Australia Pty Limited**, North Ryde (AU)

DESCRIPTION

(*) Notice: This patent is subject to a terminal disclaimer.

FIG. 1 is a front perspective view of a gaming machine showing our new design;
FIG. 2 is a front view of the gaming machine shown in FIG. 1;
FIG. 3 is a back view of the gaming machine shown in FIG. 1;
FIG. 4 is a right side view of the gaming machine shown in FIG. 1;
FIG. 5 is a left side view of the gaming machine shown in FIG. 1;
FIG. 6 is a top view of the gaming machine shown in FIG. 1;
FIG. 7 is a bottom view of the gaming machine shown in FIG. 1;
FIG. 8 is a front perspective view of a gaming machine showing an alternative embodiment of our new design;
FIG. 9 is a front view of the gaming machine shown in FIG. 8;
FIG. 10 is a back view of the gaming machine shown in FIG. 8;
FIG. 11 is a right side view of the gaming machine shown in FIG. 8;
FIG. 12 is a left side view of the gaming machine shown in FIG. 8;
FIG. 13 is a top view of the gaming machine shown in FIGS. 8; and,
FIG. 14 is a bottom view of the gaming machine shown in FIG. 8.

(**) Term: **15 Years**

(21) Appl. No.: **29/684,922**

(22) Filed: **Mar. 25, 2019**

(51) **LOC (13) Cl.** **21-03**

(52) **U.S. Cl.**
USPC **D21/369**

(58) **Field of Classification Search**
USPC D21/369, 370, 371, 385, 329, 325, 394;
D14/307, 172, 129, 325, 401, 371, 126,
(Continued)

(56) **References Cited**

U.S. PATENT DOCUMENTS

D415,124 S 10/1999 Rooyakkers
D428,864 S 8/2000 Rooyakkers
(Continued)

OTHER PUBLICATIONS

Office Action dated Jun. 1, 2020 for U.S. Appl. No. 29/684,808 (pp. 1-9).

The broken line showing of portions of the gaming machine depicts environment and forms no part of the claimed design.

(Continued)

1 Claim, 14 Drawing Sheets

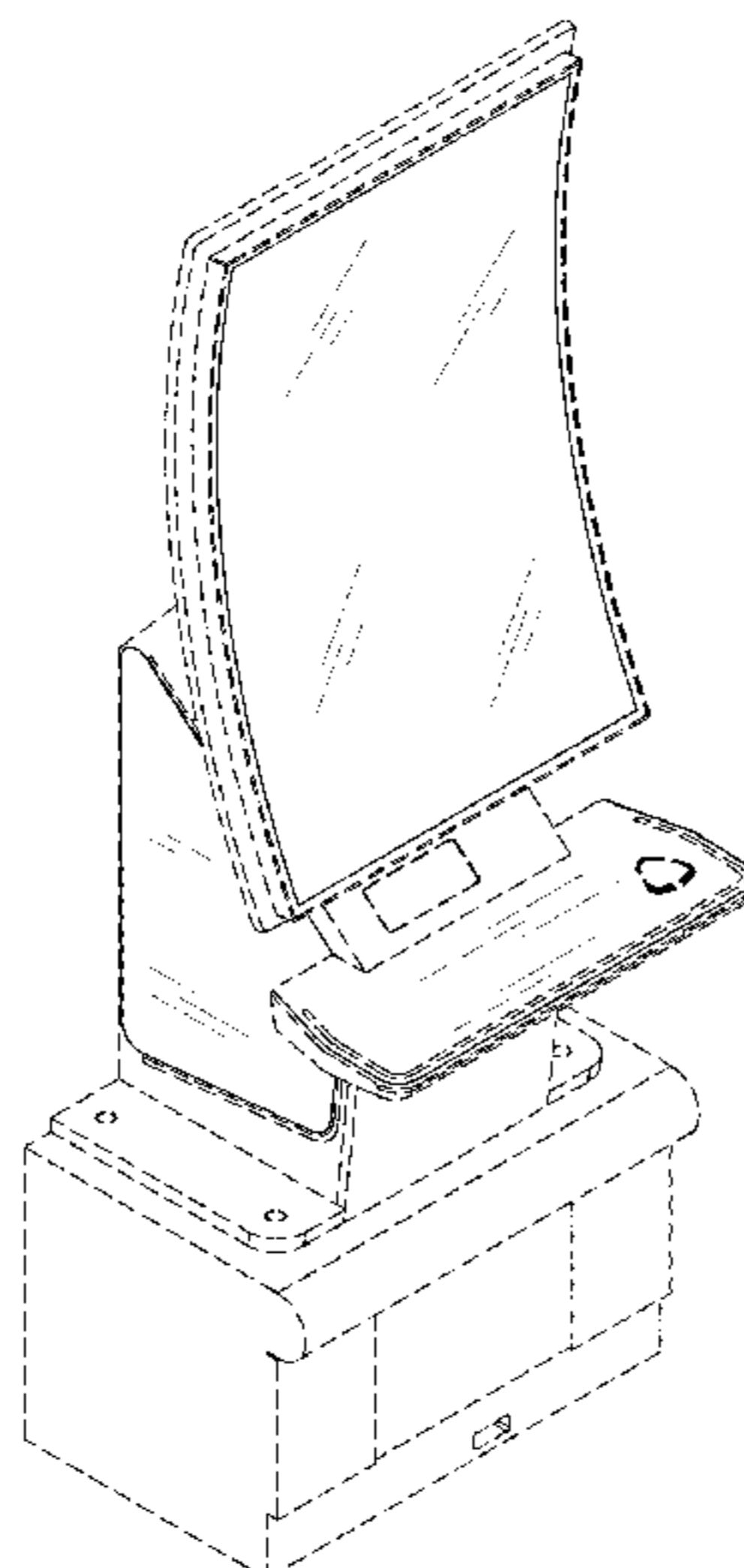

US D907,125 S

(58) **Field of Classification Search**

USPC D14/439, 432, 450, 128, 375, 248, 374,
D14/341, 138 G, 127; 463/28, 13, 11,
463/16, 20, 25, 31, 46, 23, 30, 17, 36, 29,
463/42, 34, 32, 35, 19, 21, 22; 273/292,
273/203, 138.2, 143 R, 142 R, 138.1;
D19/60; D16/226; D8/335, 331, 334;
D26/141; D7/641
CPC G07F 17/32; G07F 17/34; G07F 17/3211;
G07F 17/3244; G07F 17/3267
See application file for complete search history.

(56) **References Cited**

U.S. PATENT DOCUMENTS

D464,377 S 10/2002 Wurz
D479,243 S 9/2003 Ohashi
D508,719 S 8/2005 de Haas
D513,044 S 12/2005 Morrison
6,997,810 B2 2/2006 Cole
D531,677 S 11/2006 Mallory
D546,893 S 7/2007 Yamashita
D560,724 S 1/2008 Johnson
D560,725 S 1/2008 Johnson
D562,338 S 2/2008 Keohane
D572,314 S 7/2008 Vallejo
D579,456 S 10/2008 Chen
D587,319 S 2/2009 Moises Deiab
D599,858 S 9/2009 Lesley
D599,859 S 9/2009 Lesley
D604,773 S 11/2009 De Viveiros Ortiz
D612,432 S 3/2010 De Viveiros Ortiz
D613,802 S 4/2010 Meyers
D619,177 S 7/2010 Lee
D622,781 S 8/2010 Lesley
D626,182 S 10/2010 Cole
D628,208 S 11/2010 Potemski
D646,337 S * 10/2011 Kelly D21/329
D652,454 S 1/2012 Yopez
D666,625 S 9/2012 Gilmore
D668,261 S 10/2012 Arnold
D673,620 S 1/2013 Johnson
D673,621 S 1/2013 Johnson
D677,736 S 3/2013 Dorn
D678,956 S 3/2013 Lesley
D679,722 S 4/2013 Ray
D685,033 S 6/2013 Wudtke
D689,899 S 9/2013 Lee
D691,665 S 10/2013 Chudek
D693,841 S 11/2013 Velasco
D695,733 S 12/2013 Damhuis
D697,558 S 1/2014 Myers
D704,273 S 5/2014 Chudek
D706,741 S * 6/2014 Myers D14/172
D707,646 S 6/2014 Kim
D713,841 S 9/2014 Lim
8,832,598 B2 9/2014 Hirata
D719,616 S 12/2014 Inoue
D723,626 S 3/2015 Vasquez
D727,431 S 4/2015 Themann
D728,585 S 5/2015 Lee
D730,993 S 6/2015 Castro
D732,520 S 6/2015 Themann
D734,733 S * 7/2015 Park D14/138 G
D736,171 S * 8/2015 Lee D14/138 G
D740,887 S 10/2015 Randazzo
D740,888 S * 10/2015 DePalma D21/370
D742,974 S 11/2015 Lesley
D749,342 S 2/2016 Escandon
D759,096 S 6/2016 Seo
D760,275 S 6/2016 Zhang
D765,136 S 8/2016 Lee
RE46,169 E * 10/2016 Kelly G07F 17/34
D21/370
D772,240 S 11/2016 Edstrom
D772,273 S 11/2016 Spector

D773,512 S 12/2016 Miura
D780,852 S 3/2017 Sharp
D785,664 S 5/2017 Yao
D790,563 S 6/2017 Lam
9,679,435 B2 6/2017 Schrementi
9,704,337 B2 7/2017 Riggs
D794,661 S 8/2017 Nishizawa
D794,664 S 8/2017 Okabe
D801,435 S 10/2017 Themann
D803,323 S 11/2017 Bussey
D803,324 S 11/2017 Bussey
D809,068 S 1/2018 Ballman
D809,069 S 1/2018 Ballman
D812,146 S 3/2018 Castro
D812,147 S 3/2018 Castro
D812,148 S 3/2018 Castro
D812,149 S 3/2018 Castro
D814,455 S 4/2018 Kwon
D816,079 S 4/2018 Yamazaki
D818,048 S 5/2018 Calhoun
D819,747 S 6/2018 Castro
D820,915 S * 6/2018 Lee D21/369
D826,338 S 8/2018 Bussey
D832,356 S 10/2018 Castro
D833,534 S 11/2018 Lee
D834,652 S 11/2018 Lee
10,127,761 B2 * 11/2018 Woels G07F 17/3209
10,181,236 B2 1/2019 Goldstein
D843,458 S 3/2019 Castro
D843,467 S * 3/2019 Johnson D21/369
D843,468 S * 3/2019 Johnson D21/369
D843,473 S * 3/2019 Zedell, Jr. D21/369
D843,474 S * 3/2019 Lesley D21/369
D843,475 S * 3/2019 Lesley D21/369
D843,476 S * 3/2019 Lesley D21/369
D843,477 S 3/2019 Lesley
D843,478 S 3/2019 Lesley
D843,479 S 3/2019 Castro
D843,480 S 3/2019 Castro
D843,482 S 3/2019 Holland
D844,062 S 3/2019 Lesley
D846,650 S 4/2019 Stair
D847,905 S 5/2019 Lewis
D849,149 S 5/2019 Bussey
D849,150 S 5/2019 Gallagher
D850,536 S * 6/2019 Stair D21/370
D850,537 S 6/2019 Urban
D854,621 S 7/2019 Calhoun
D858,641 S 9/2019 Legras
D858,642 S 9/2019 Legras
D859,347 S 9/2019 Kwon
D862,602 S 10/2019 Kariya
D865,066 S 10/2019 Ortiz De Viveiros
D865,873 S 11/2019 Lewis
D866,666 S 11/2019 Ditton
D866,667 S * 11/2019 Stair D21/369
D866,668 S 11/2019 Ditton
D868,165 S 11/2019 Ortiz De Viveiros
D870,818 S 12/2019 Curbbun
D870,820 S 12/2019 Urban
D871,506 S 12/2019 Castro
D871,507 S 12/2019 Urban
D872,190 S 1/2020 Zedell, Jr.
D875,091 S 2/2020 Kwon
10,580,252 B2 3/2020 Whelan
D880,605 S 4/2020 Bussey
D880,606 S 4/2020 Glenn, II
D880,608 S 4/2020 Glenn, II
D880,610 S 4/2020 Glenn, II
D880,611 S 4/2020 Glenn, II
D880,612 S * 4/2020 Bernard D21/369
D880,613 S * 4/2020 Bernard D21/369
D880,614 S * 4/2020 Bernard D21/369
D880,615 S * 4/2020 Bernard D21/369
D881,284 S 4/2020 Glenn
D881,285 S 4/2020 Glenn
D882,697 S 4/2020 Lesley
2013/0084948 A1 4/2013 Watkins
2014/0335934 A1 11/2014 Meyer

(56)

References Cited

U.S. PATENT DOCUMENTS

2015/0018070	A1	1/2015	Meyer	
2015/0036073	A1	2/2015	Im	
2016/0093143	A1*	3/2016	Lamb G07F 17/323 463/20
2016/0195938	A1	7/2016	Kim	
2017/0039802	A1	2/2017	Prabhu	
2017/0046906	A1	2/2017	Hilbert	
2017/0092052	A1	3/2017	McKay	
2017/0301177	A1	10/2017	Pawloski	
2018/0075689	A1	3/2018	Castro	
2018/0078847	A1	3/2018	Sorreta	
2018/0078854	A1	3/2018	Achmueller	
2018/0082523	A1	3/2018	Palermo	
2019/0012874	A1*	1/2019	Goldstein G07F 17/3211
2019/0046872	A1	2/2019	Glenn, II	
2019/0096161	A1*	3/2019	Barbour G07F 17/3216
2019/0096170	A1	3/2019	Lewis	
2019/0096173	A1	3/2019	Brandau	
2019/0102971	A1	4/2019	Schoonmaker	
2019/0102974	A1	4/2019	Bussey	
2019/0102984	A1	4/2019	Gallagher	
2019/0287337	A1	9/2019	Shiraishi	
2020/0111291	A1	4/2020	Pariseau	
2020/0111295	A1	4/2020	Glenn	
2020/0111296	A1	4/2020	Miura	
2020/0111297	A1	4/2020	Kazama	
2020/0111328	A1	4/2020	Bland	

OTHER PUBLICATIONS

Office Action dated Jun. 1, 2020 for U.S. Appl. No. 29/684,812 (pp. 1-9).
 Office Action dated Jun. 1, 2020 for U.S. Appl. No. 29/684,832 (pp. 1-9).
 Office Action dated Jun. 1, 2020 for U.S. Appl. No. 29/684,836 (pp. 1-9).
 Office Action dated Jun. 1, 2020 for U.S. Appl. No. 29/684,844 (pp. 1-9).
 Office Action dated Jun. 1, 2020 for U.S. Appl. No. 29/684,849 (pp. 1-9).
 Office Action dated Jun. 5, 2020 for U.S. Appl. No. 29/684,847 (pp. 1-9).
 Office Action dated Jun. 12, 2020 for U.S. Appl. No. 29/684,810 (pp. 1-10).
 Office Action dated Jun. 12, 2020 for U.S. Appl. No. 29/684,814 (pp. 1-10).

Office Action dated Jun. 12, 2020 for U.S. Appl. No. 29/684,817 (pp. 1-11).
 Office Action dated Jun. 12, 2020 for U.S. Appl. No. 29/684,838 (pp. 1-11).
 Office Action dated Jun. 12, 2020 for U.S. Appl. No. 29/684,842 (pp. 1-11).
 Office Action dated Jun. 12, 2020 for U.S. Appl. No. 29/684,883 (pp. 1-8).
 Office Action dated Jun. 12, 2020 for U.S. Appl. No. 29/684,890 (pp. 1-9).
 Office Action dated Jun. 12, 2020 for U.S. Appl. No. 29/684,891 (pp. 1-9).
 Office Action dated Jun. 12, 2020 for U.S. Appl. No. 29/684,894 (pp. 1-10).
 Office Action dated Jun. 12, 2020 for U.S. Appl. No. 29/684,899 (pp. 1-9).
 Office Action dated Jun. 12, 2020 for U.S. Appl. No. 29/684,915 (pp. 1-10).
 Office Action dated Jun. 12, 2020 for U.S. Appl. No. 29/684,925 (pp. 1-10).
 Office Action dated Jun. 12, 2020 for U.S. Appl. No. 29/684,929 (pp. 1-10).
 Office Action dated Jun. 12, 2020 for U.S. Appl. No. 29/684,934 (pp. 1-10).
 Office Action dated Jun. 12, 2020 for U.S. Appl. No. 29/684,936 (pp. 1-10).
 Office Action dated Jun. 12, 2020 for U.S. Appl. No. 29/684,941 (pp. 1-12).
 Office Action dated Jul. 10, 2020 for U.S. Appl. No. 29/684,900 (pp. 1-10).
 Office Action dated Jul. 10, 2020 for U.S. Appl. No. 29/684,938 (pp. 1-13).
 Notice of Allowance dated Aug. 5, 2020 for U.S. Appl. No. 29/678,496 (pp. 1-7).
 Office Action dated Jun. 1, 2020 for U.S. Appl. No. 29/684,806 (pp. 1-9).
 Office Action dated Jun. 1, 2020 for U.S. Appl. No. 29/684,807 (pp. 1-8).
 Office Action dated Jun. 1, 2020 for U.S. Appl. No. 29/684,809 (pp. 1-7).
 Office Action dated Jun. 1, 2020 for U.S. Appl. No. 29/684,811 (pp. 1-7).
 Office Action dated Jun. 12, 2020 for U.S. Appl. No. 29/684,912 (pp. 1-10).
 Corrected Notice of Allowability dated Aug. 17, 2020 for U.S. Appl. No. 29/678,496 (pp. 1-4).

* cited by examiner

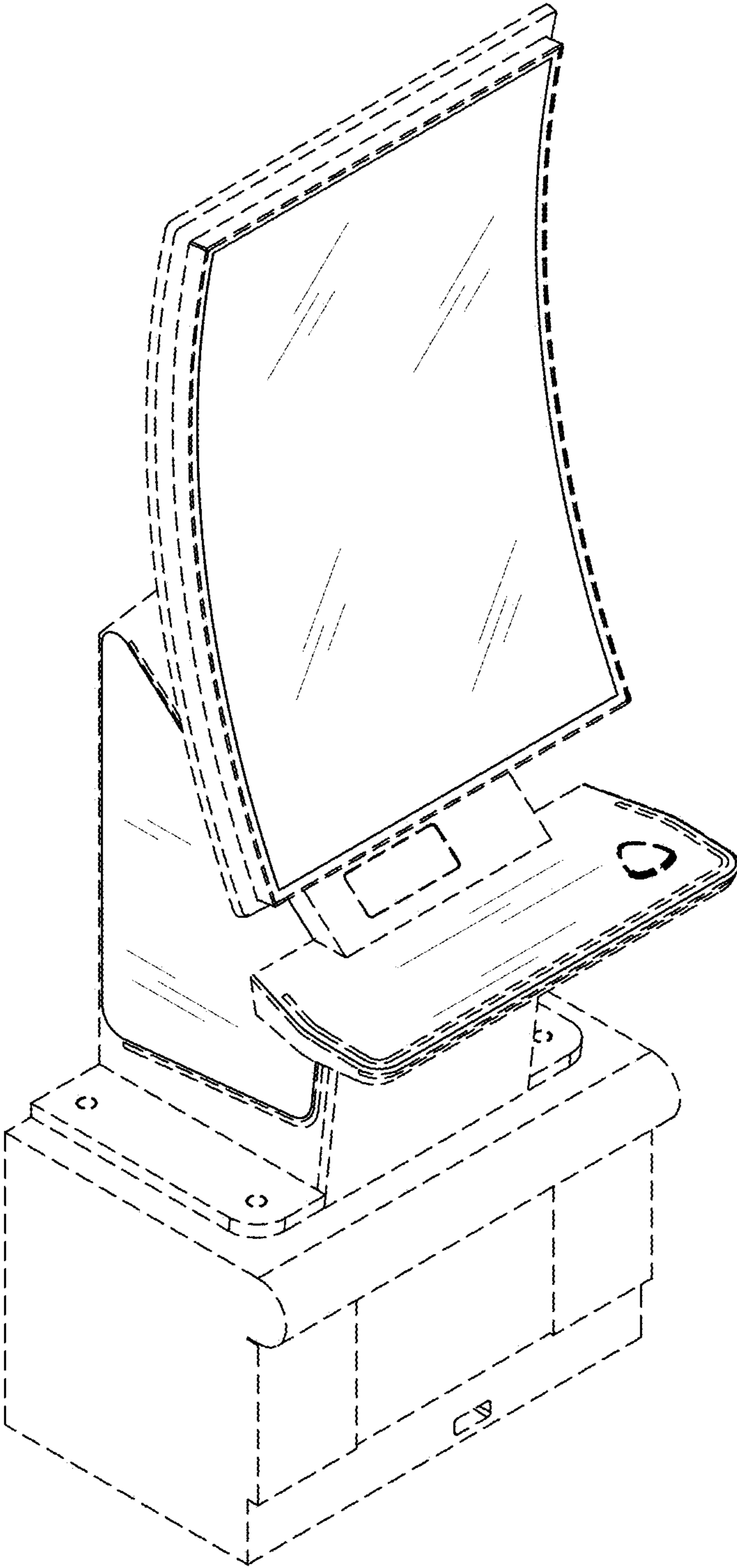

FIG. 1

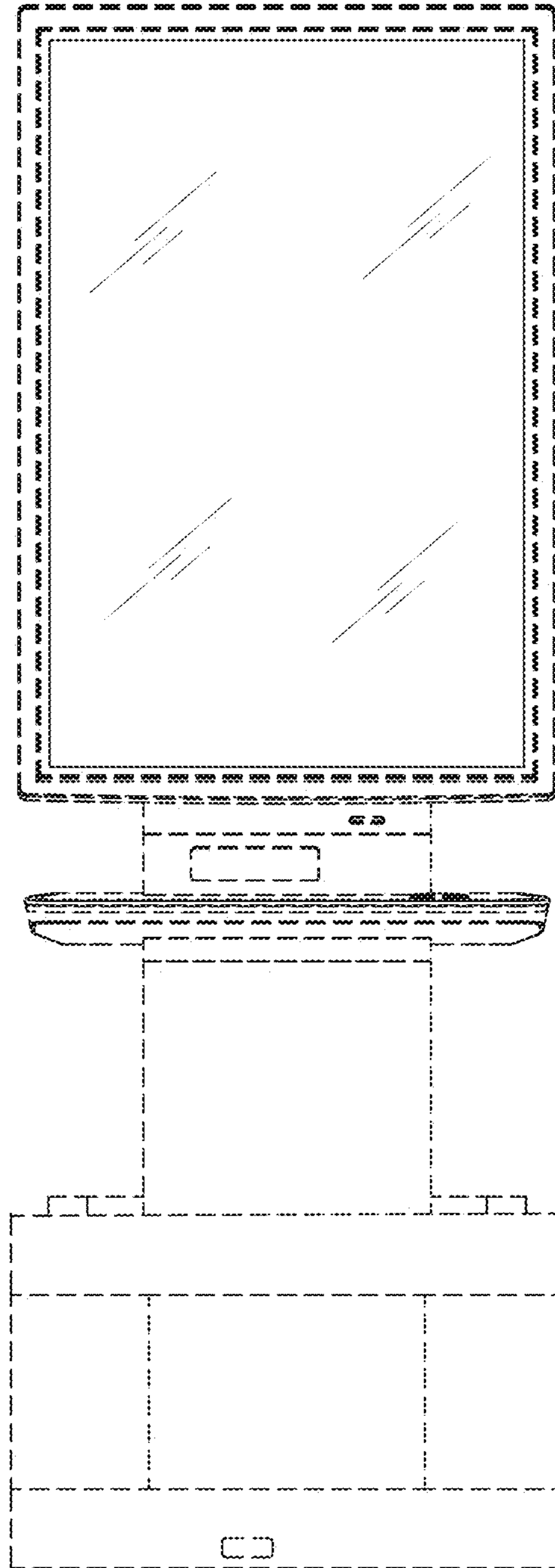

FIG. 2

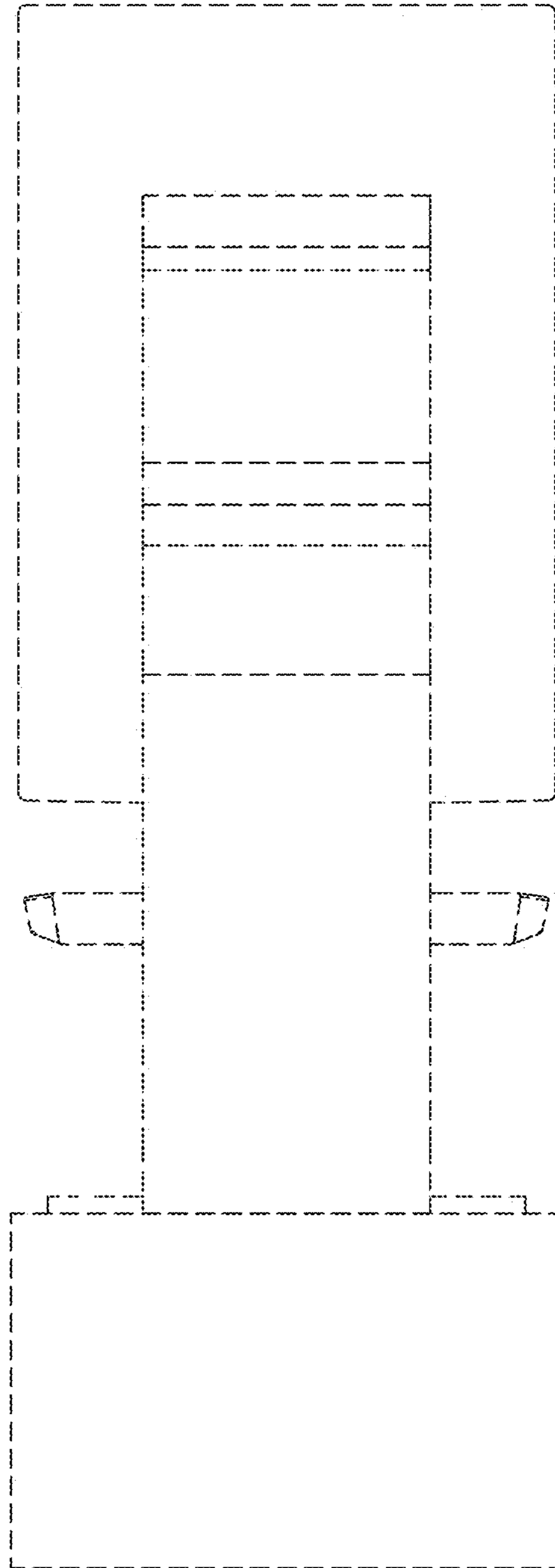

FIG. 3

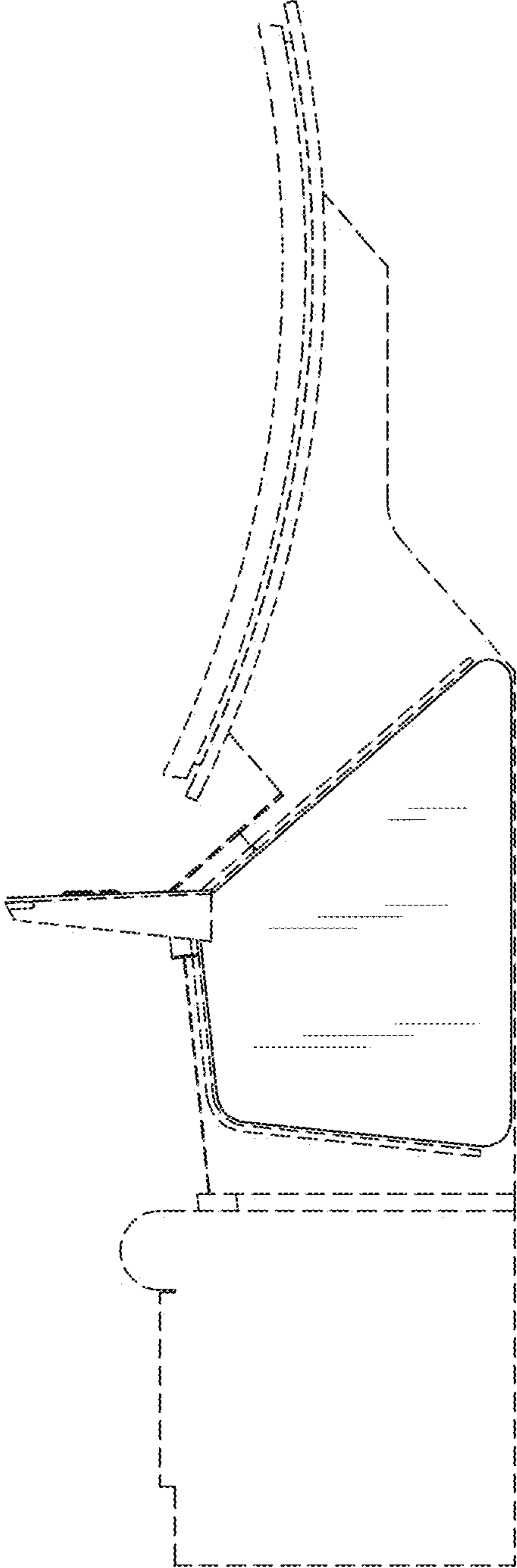

FIG. 4

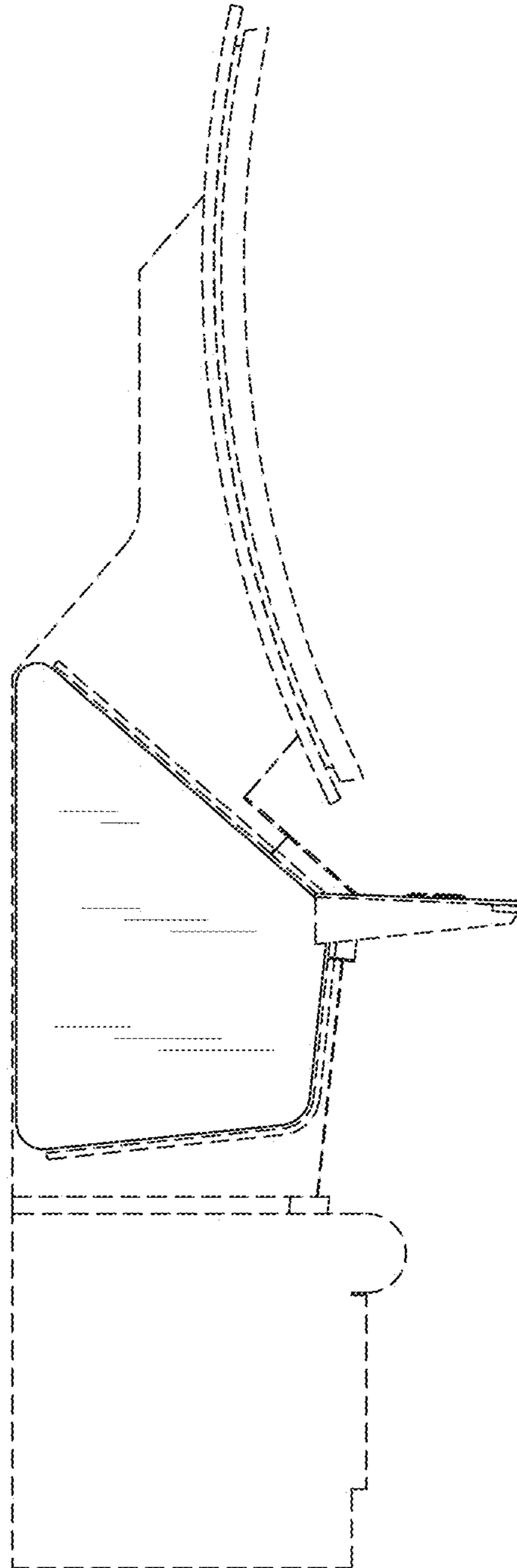

FIG. 5

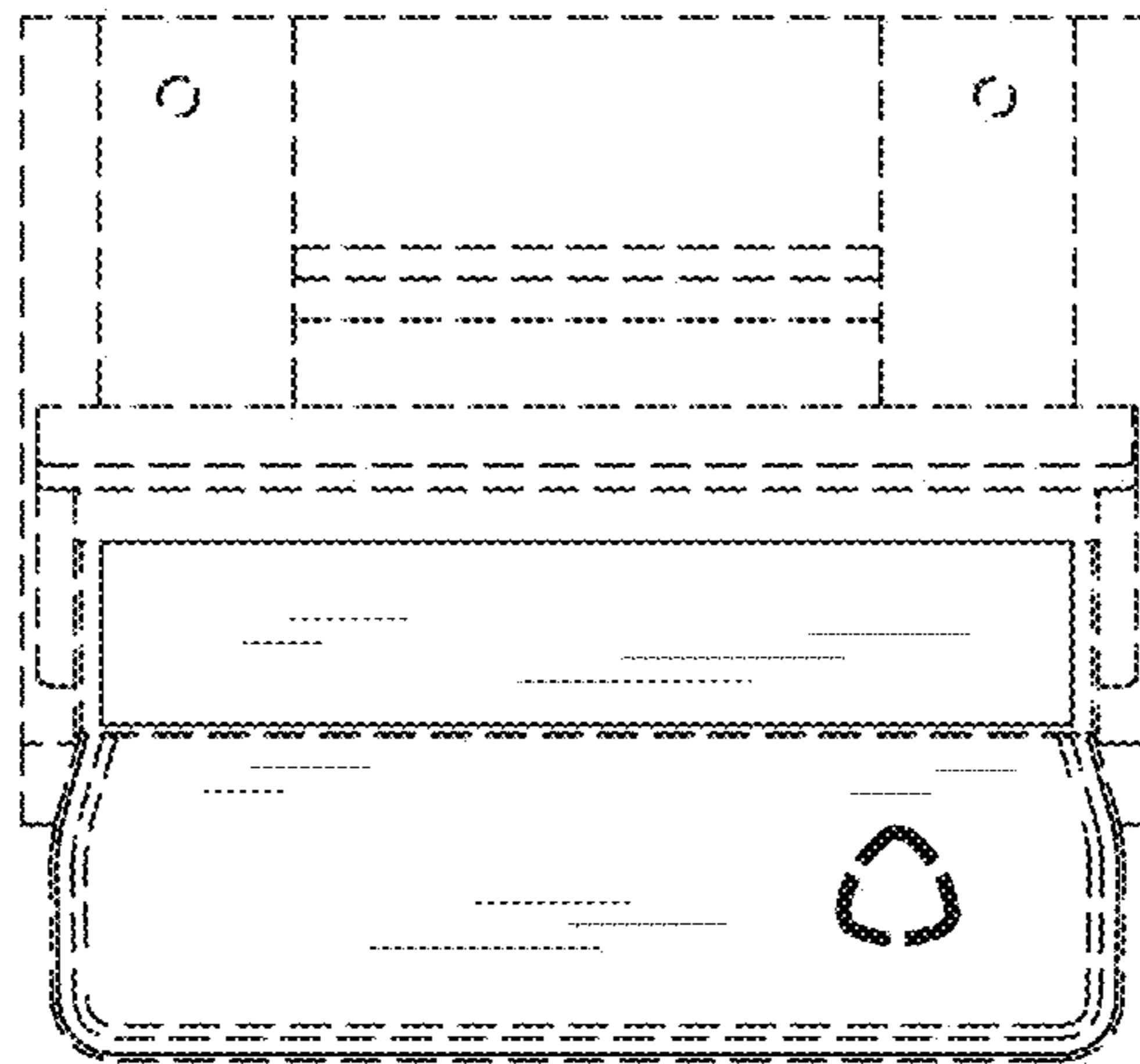

FIG. 6

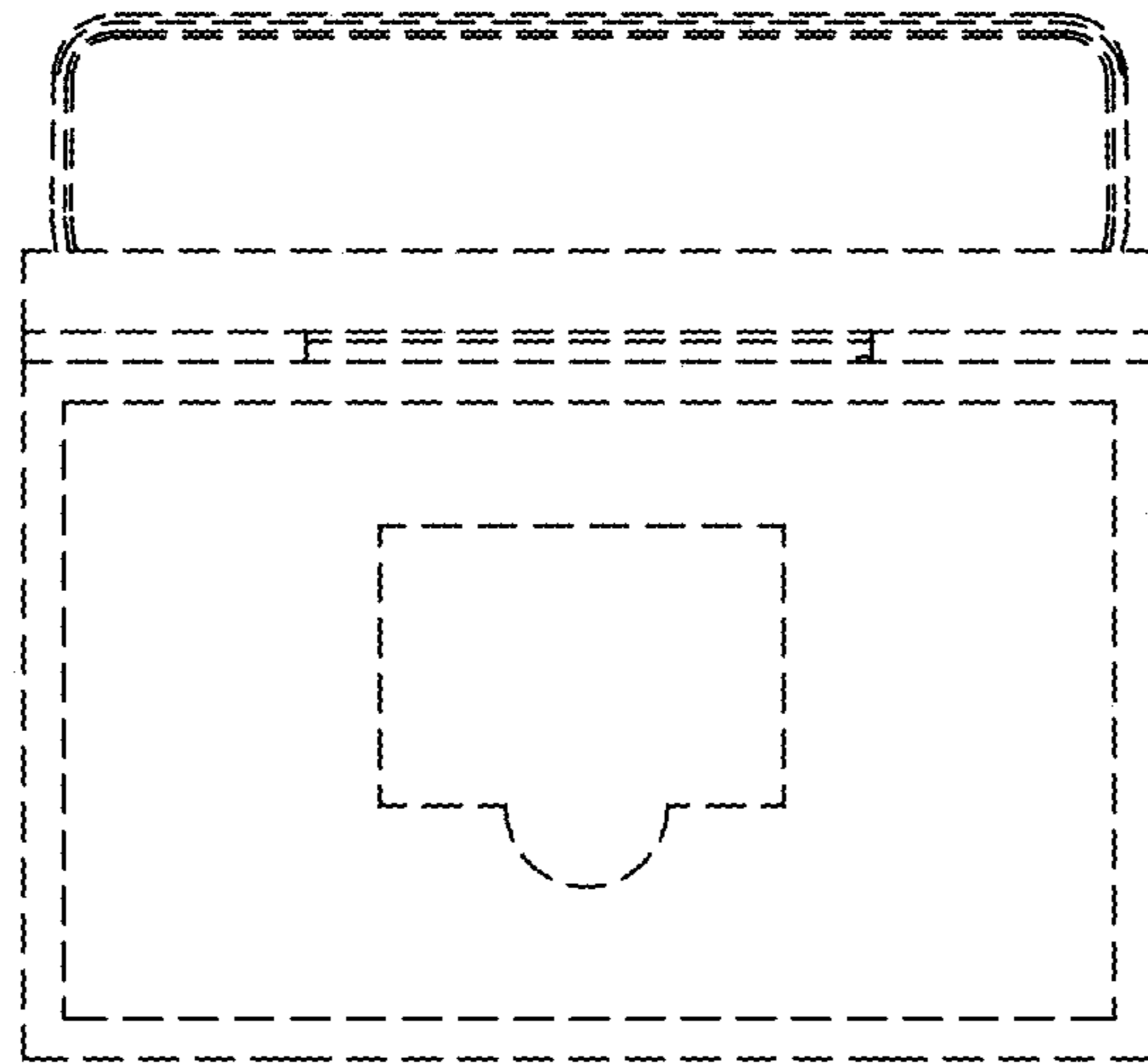

FIG. 7

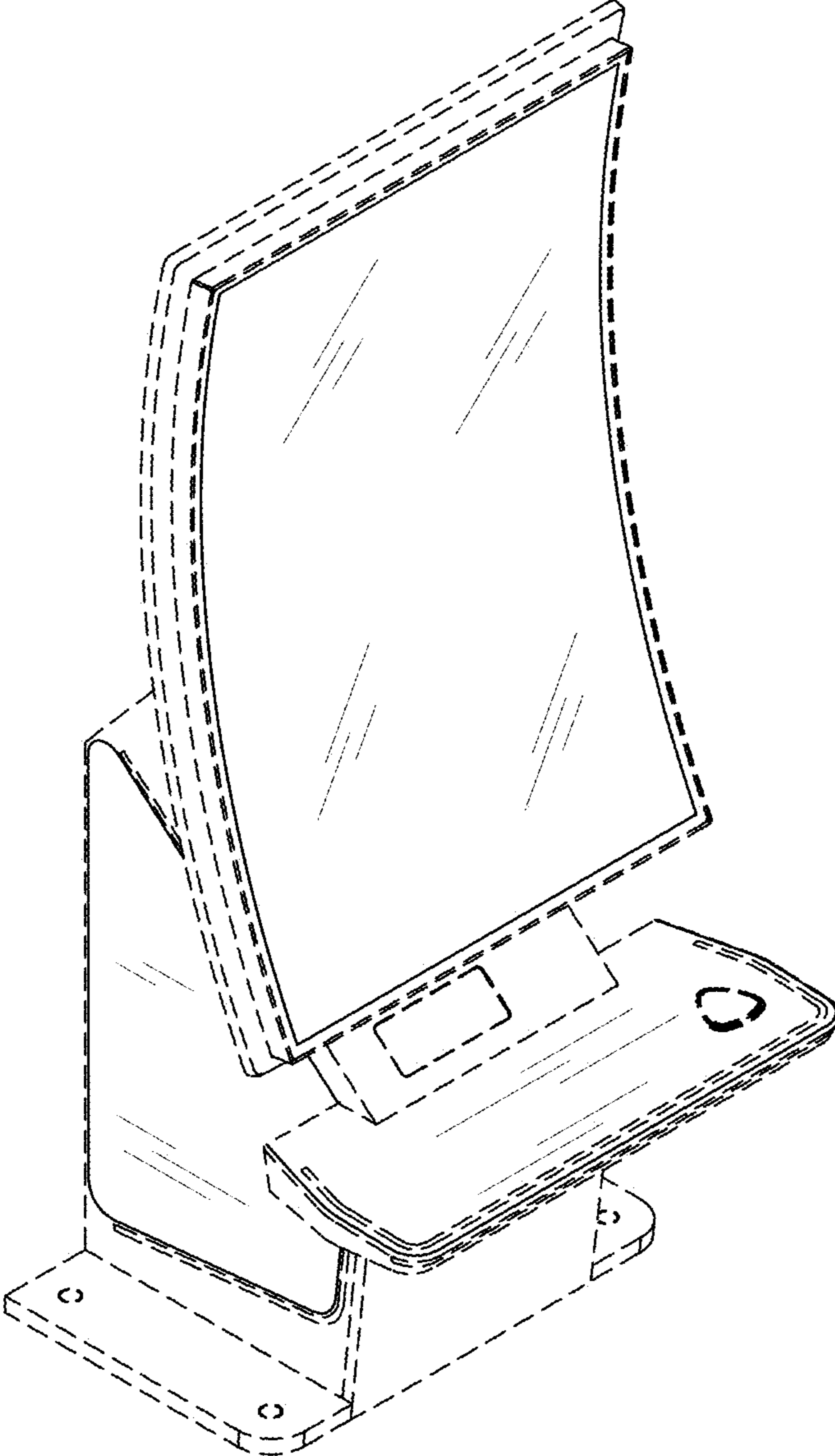

FIG. 8

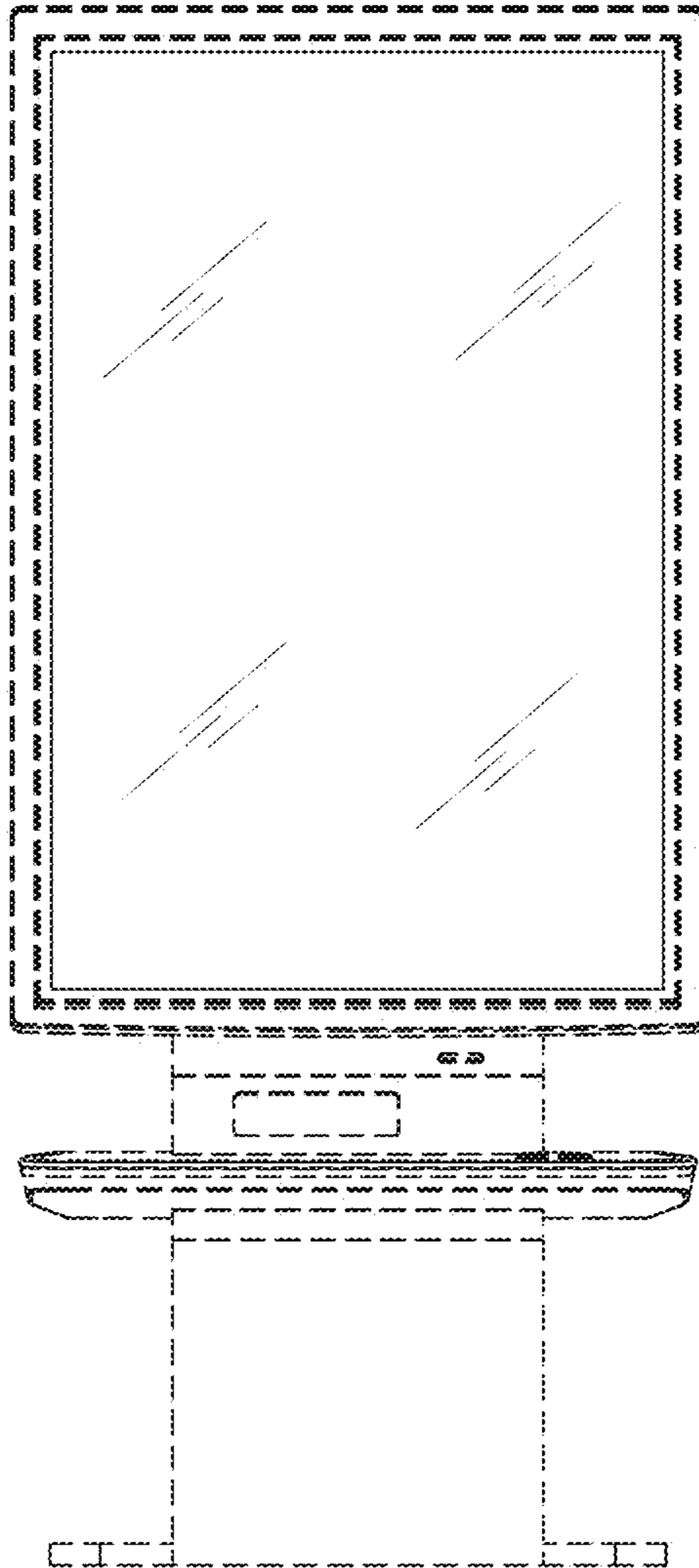

FIG. 9

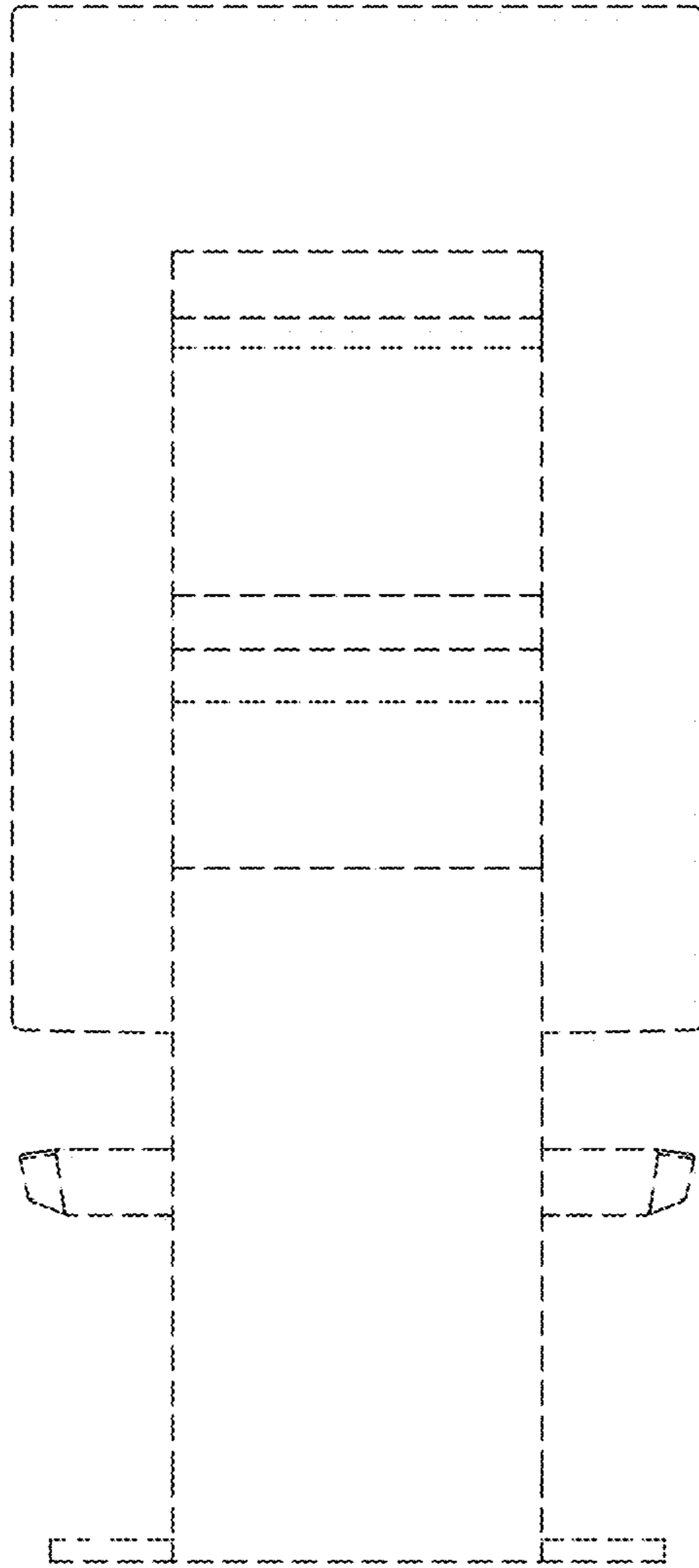

FIG. 10

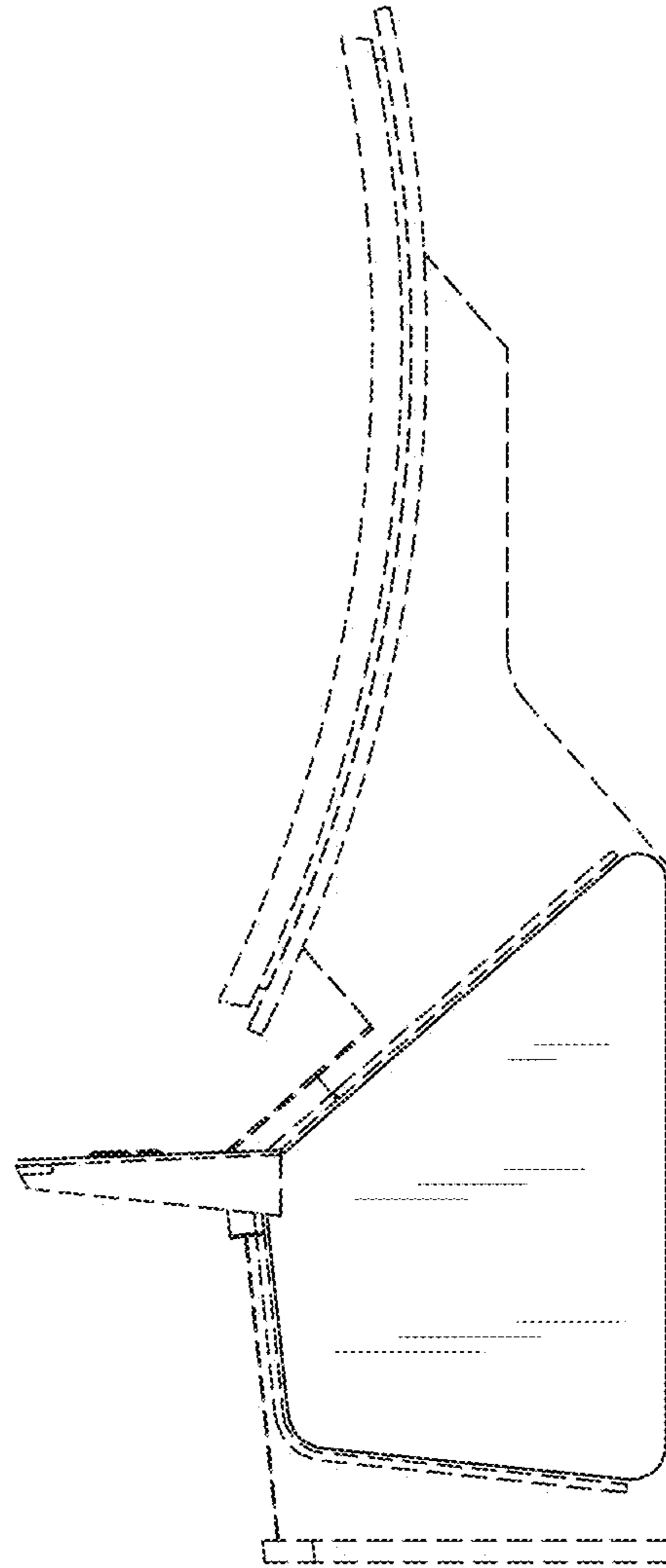

FIG. 11

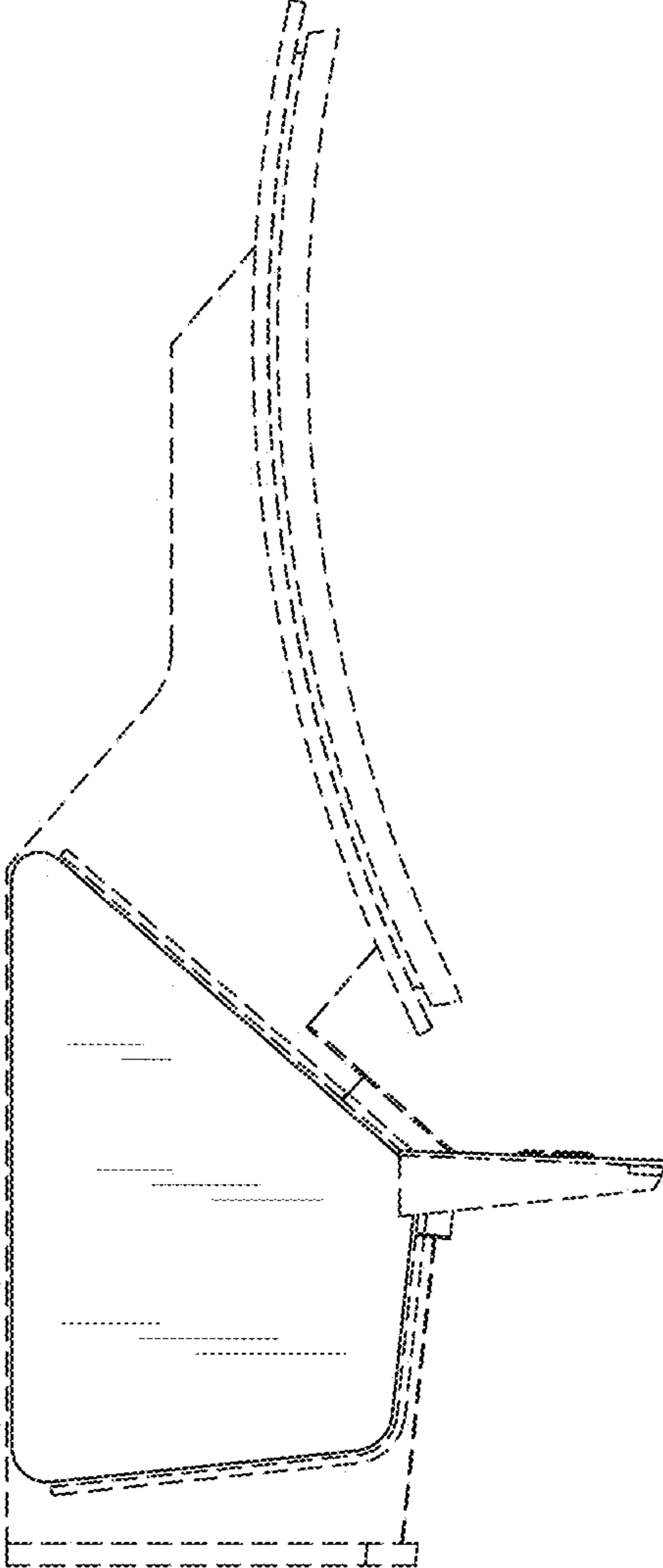

FIG. 12

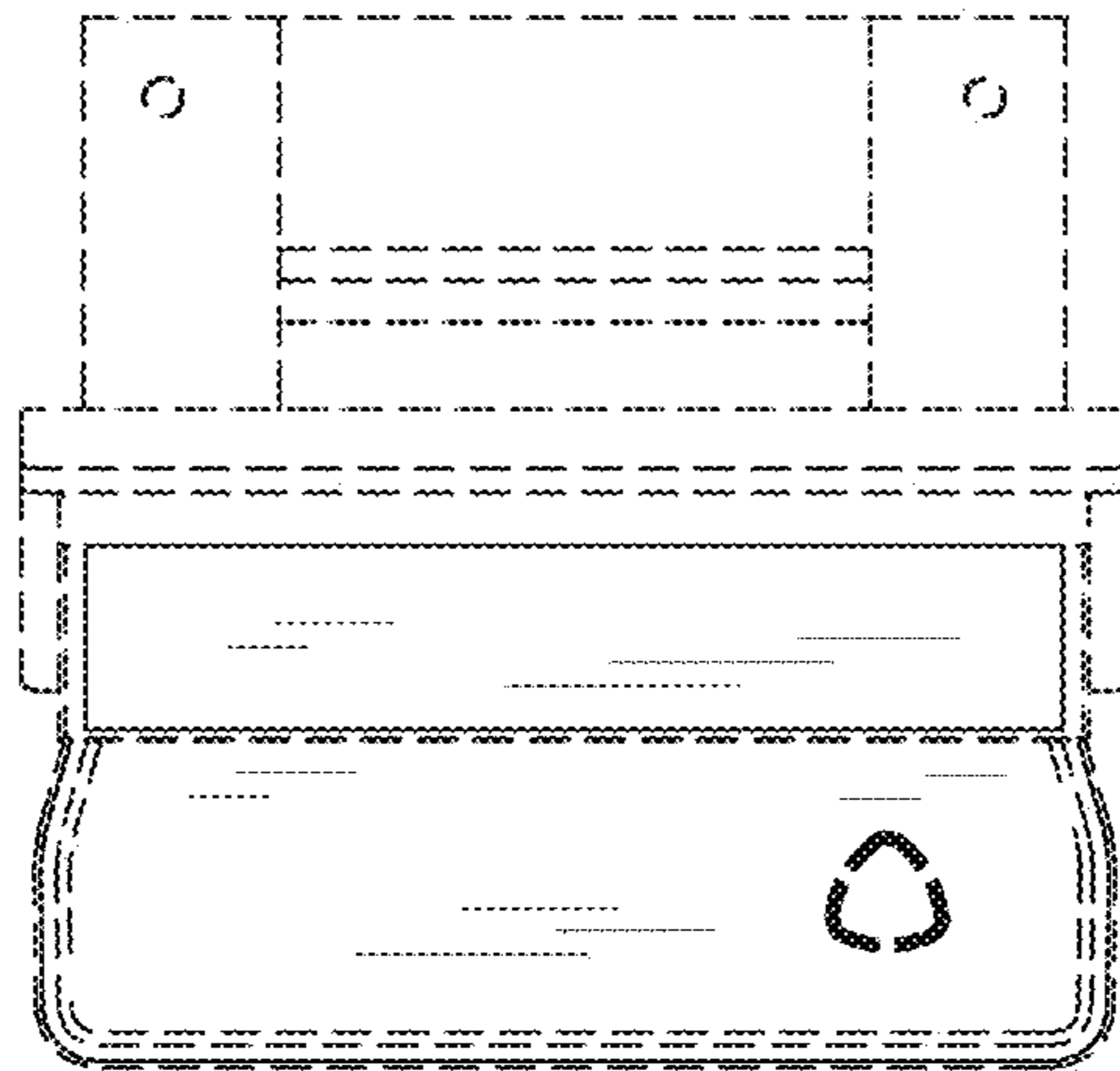

FIG. 13

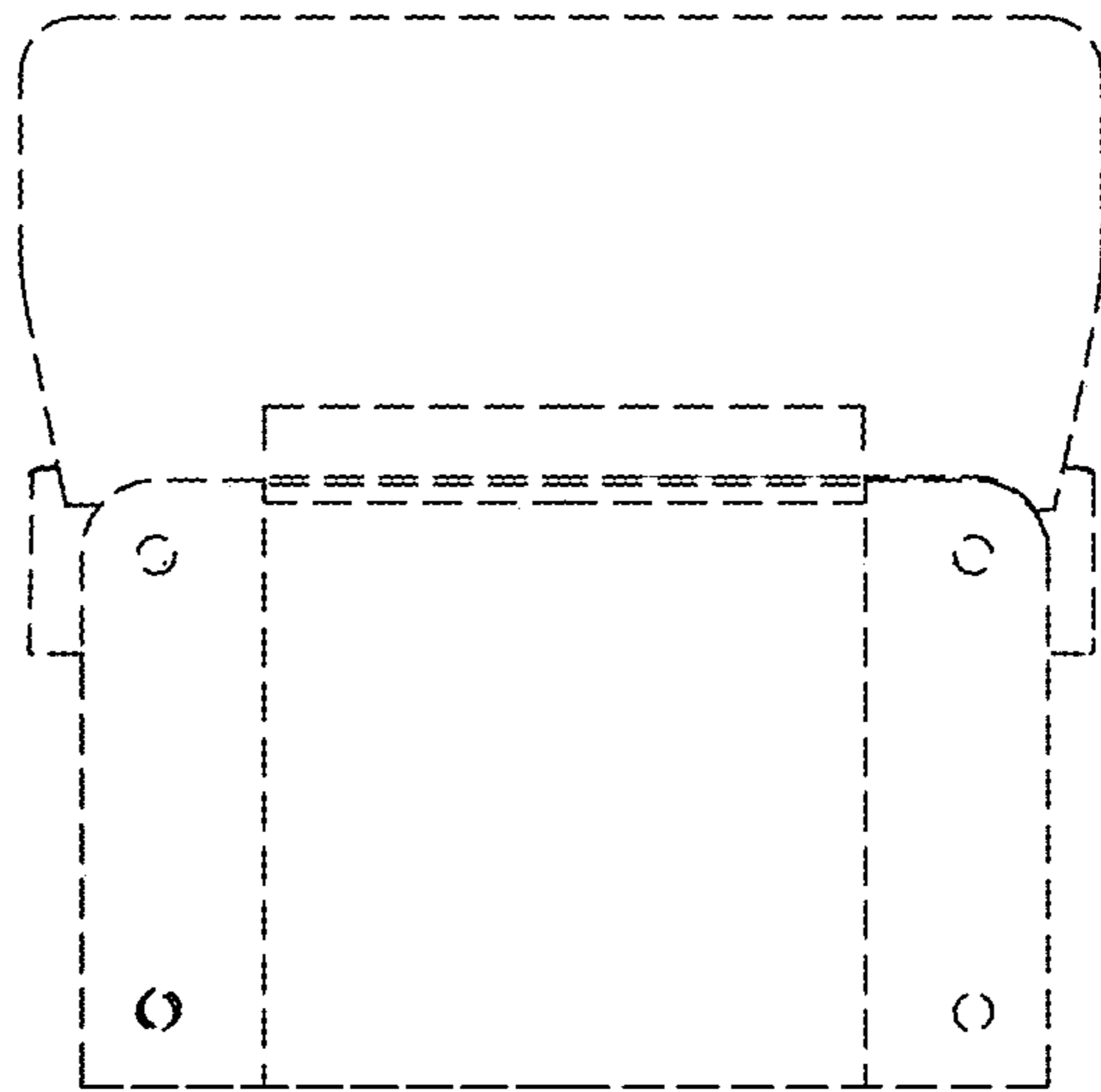

FIG. 14