



US00D907122S

(12) **United States Design Patent** (10) **Patent No.:** **US D907,122 S**  
**DeMarco et al.** (45) **Date of Patent:** **\*\* Jan. 5, 2021**

(54) **GAMING MACHINE**

(71) Applicant: **ARISTOCRAT TECHNOLOGIES AUSTRALIA PTY LIMITED**, North Ryde (AU)

(72) Inventors: **Dominic J. DeMarco**, Round Rock, TX (US); **Bruce Edward Urban**, Las Vegas, NV (US); **James Franklin Stair**, Las Vegas, NV (US); **Ariel David Turgel**, San Francisco, CA (US); **Daniel Harden**, Palo Alto, CA (US); **Alexander Abele**, Aalen (DE)

(73) Assignee: **Aristocrat Technologies Australia Pty Limited**, North Ryde (AU)

(\*\*) Term: **15 Years**

(21) Appl. No.: **29/684,832**

(22) Filed: **Mar. 25, 2019**

(51) **LOC (13) Cl.** ..... **21-03**

(52) **U.S. Cl.**  
 USPC ..... **D21/369**

(58) **Field of Classification Search**  
 USPC ..... D21/369, 370, 371, 385, 329, 325, 394; D14/307, 172, 129, 325, 401, 371, 126, D14/439, 432, 450, 128, 375, 248, 374, D14/341, 138 G, 127; 463/28, 13, 11, 463/16, 20, 25, 31, 46, 23, 30, 17, 36, 29, 463/42, 34, 32, 35, 19, 21, 22; 273/292, 273/203, 138.2, 143 R, 142 R, 138.1; D19/60; D16/226; D8/335, 331, 334; D26/141; D7/641  
 CPC ..... G07F 17/32; G07F 17/34; G07F 17/3211; G07F 17/3244; G07F 17/3267  
 See application file for complete search history.

D464,377 S	10/2002	Wurz	
D479,243 S	9/2003	Ohashi	
D508,719 S	8/2005	de Haas	
D513,044 S	12/2005	Morrison	
6,997,810 B2	2/2006	Cole	
D531,677 S	11/2006	Mallory	
D546,893 S	7/2007	Yamashita	
D560,724 S	* 1/2008	Johnson	D21/329
D560,725 S	* 1/2008	Johnson	D21/329
D562,338 S	2/2008	Keohane	
D572,314 S	7/2008	Vallejo	
D579,456 S	10/2008	Chen	
D587,319 S	2/2009	Moises Deiab	
D599,858 S	9/2009	Lesley	
D599,859 S	9/2009	Lesley	
D604,773 S	11/2009	De Viveiros Ortiz	
D612,432 S	3/2010	De Viveiros Ortiz	
D613,802 S	4/2010	Meyers	
D619,177 S	7/2010	Lee	
D622,781 S	8/2010	Lesley	
D626,182 S	10/2010	Cole	
D628,208 S	11/2010	Potemski	
D646,337 S	10/2011	Kelly	
D652,454 S	1/2012	Yepez	
D666,625 S	9/2012	Gilmore	
D668,261 S	10/2012	Arnold	
D673,620 S	1/2013	Johnson	
D673,621 S	1/2013	Johnson	
D677,736 S	* 3/2013	Dorn	D21/370
D678,956 S	3/2013	Lesley	
D679,722 S	4/2013	Ray	
D685,033 S	6/2013	Wudtke	
D689,899 S	9/2013	Lee	
D691,665 S	10/2013	Chudek	
D693,841 S	11/2013	Velasco	
D695,733 S	12/2013	Damhuis	
D697,558 S	* 1/2014	Myers	D21/325
D704,273 S	5/2014	Chudek	
D706,741 S	6/2014	Myers	
D707,646 S	* 6/2014	Kim	D14/138 G
D713,841 S	* 9/2014	Lim	D14/341
8,832,598 B2	9/2014	Hirata	
D719,616 S	* 12/2014	Inoue	D21/370
D723,626 S	3/2015	Vasquez	
D727,431 S	* 4/2015	Themann	D21/370
D728,585 S	5/2015	Lee	
D730,993 S	6/2015	Castro	
D732,520 S	* 6/2015	Themann	D14/307
D734,733 S	7/2015	Park	
D736,171 S	8/2015	Lee	
D740,887 S	* 10/2015	Randazzo	D21/370
D740,888 S	10/2015	DePalma	
D742,974 S	* 11/2015	Lesley	D21/369

(56) **References Cited**  
 U.S. PATENT DOCUMENTS  
 D415,124 S 10/1999 Rooyakkers  
 D428,864 S 8/2000 Rooyakkers

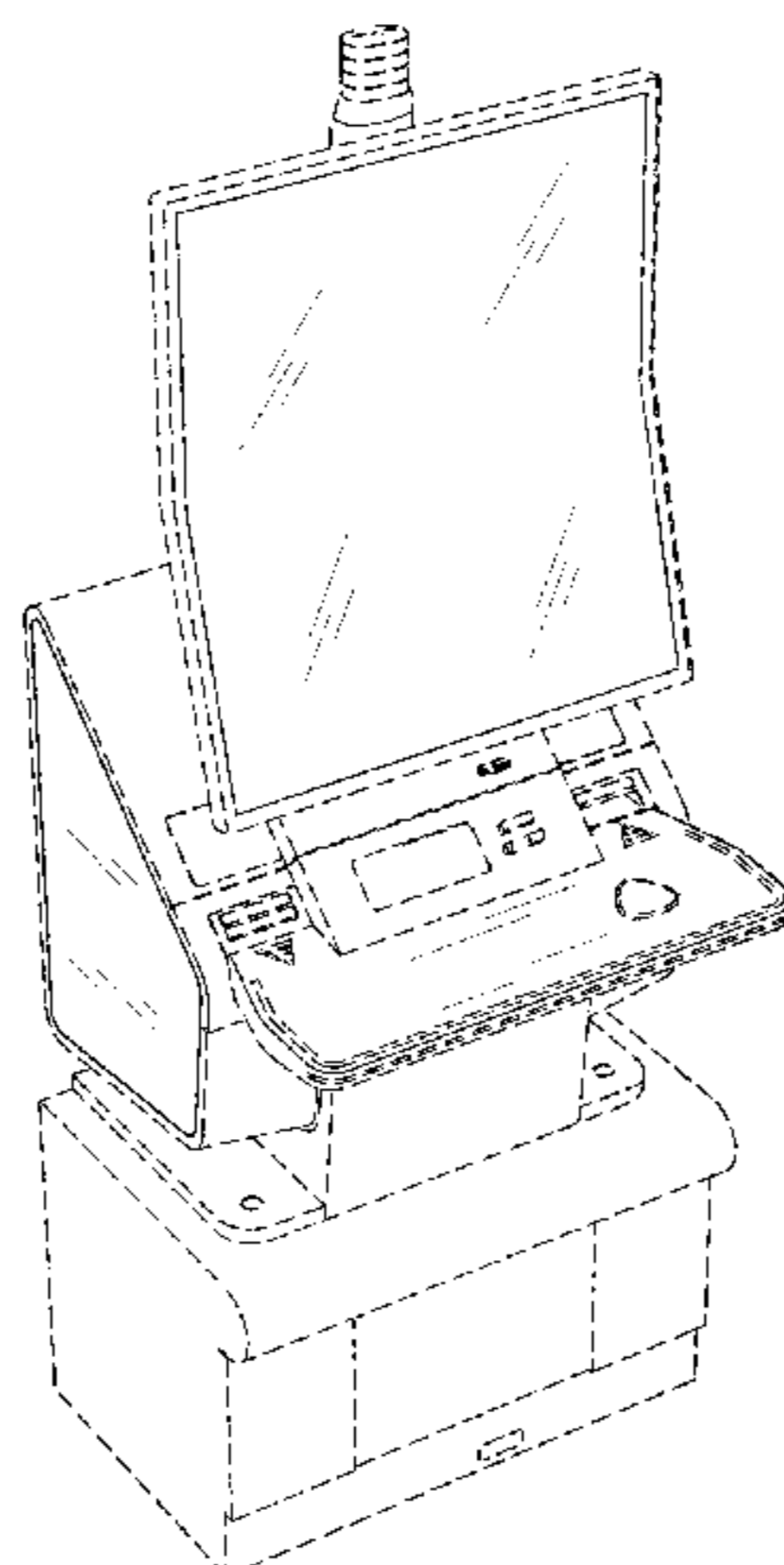

US D907,122 S

D749,342 S *	2/2016	Escandon	.....	D6/682	D880,614 S	4/2020	Bernard	
D759,096 S	6/2016	Seo			D880,615 S	4/2020	Bernard	
D760,275 S	6/2016	Zhang			D881,284 S	4/2020	Glenn	
D765,136 S	8/2016	Lee			D881,285 S	4/2020	Glenn	
RE46,169 E	10/2016	Kelly			D882,697 S	4/2020	Lesley	
D772,240 S	11/2016	Edstrom			2013/0084948 A1	4/2013	Watkins	
D772,273 S	11/2016	Spector			2014/0335934 A1	11/2014	Meyer	
D773,512 S	12/2016	Miura			2015/0018070 A1 *	1/2015	Meyer	..... G07F 17/3267
D780,852 S	3/2017	Sharp						463/20
D785,664 S	5/2017	Yao			2015/0036073 A1	2/2015	Im	
D790,563 S	6/2017	Lam			2016/0093143 A1	3/2016	Lamb	
9,679,435 B2	6/2017	Schrementi			2016/0195938 A1 *	7/2016	Kim	..... G06F 3/04886
9,704,337 B2	7/2017	Riggs						345/156
D794,661 S	8/2017	Nishizawa			2017/0039802 A1 *	2/2017	Prabhu	..... G07F 17/3211
D794,664 S	8/2017	Okabe			2017/0046906 A1 *	2/2017	Hilbert	..... G07F 17/3209
D801,435 S	10/2017	Themann			2017/0092052 A1	3/2017	McKay	
D803,323 S	11/2017	Bussey			2017/0301177 A1 *	10/2017	Pawloski	..... G07F 17/3244
D803,324 S *	11/2017	Bussey	.....	D21/370	2018/0075689 A1	3/2018	Castro	
D809,068 S	1/2018	Ballman			2018/0078847 A1	3/2018	Sorreta	
D809,069 S	1/2018	Ballman			2018/0078854 A1	3/2018	Achmueller	
D812,146 S	3/2018	Castro			2018/0082523 A1	3/2018	Palermo	
D812,147 S	3/2018	Castro			2019/0012874 A1	1/2019	Goldstein	
D812,148 S	3/2018	Castro			2019/0046872 A1 *	2/2019	Glenn, II	..... G07F 17/32
D812,149 S	3/2018	Castro			2019/0096161 A1	3/2019	Barbour	
D814,455 S *	4/2018	Kwon	.....	D14/341	2019/0096170 A1	3/2019	Lewis	
D816,079 S *	4/2018	Yamazaki	.....	D14/341	2019/0096173 A1	3/2019	Brandau	
D818,048 S	5/2018	Calhoun			2019/0102971 A1	4/2019	Schoonmaker	
D819,747 S	6/2018	Castro			2019/0102974 A1	4/2019	Bussey	
D820,915 S	6/2018	Lee			2019/0102984 A1	4/2019	Gallagher	
D826,338 S	8/2018	Bussey			2019/0287337 A1	9/2019	Shiraishi	
D832,356 S	10/2018	Castro			2020/0111291 A1	4/2020	Pariseau	
D833,534 S	11/2018	Lee			2020/0111295 A1	4/2020	Glenn	
D834,652 S	11/2018	Lee			2020/0111296 A1	4/2020	Miura	
10,127,761 B2	11/2018	Woels			2020/0111297 A1	4/2020	Kazama	
10,181,236 B2	1/2019	Goldstein			2020/0111328 A1	4/2020	Bland	
D843,458 S	3/2019	Castro						
D843,467 S	3/2019	Johnson						
D843,468 S	3/2019	Johnson						
D843,473 S	3/2019	Zedell, Jr.						
D843,474 S	3/2019	Lesley						
D843,475 S	3/2019	Lesley						
D843,476 S	3/2019	Lesley						
D843,477 S	3/2019	Lesley						
D843,478 S	3/2019	Lesley						
D843,479 S	3/2019	Castro						
D843,480 S	3/2019	Castro						
D843,482 S	3/2019	Holland						
D844,062 S	3/2019	Lesley						
D846,650 S	4/2019	Stair						
D847,905 S	5/2019	Lewis						
D849,149 S	5/2019	Bussey						
D849,150 S	5/2019	Gallagher						
D850,536 S	6/2019	Stair						
D850,537 S	6/2019	Urban						
D854,621 S	7/2019	Calhoun						
D858,641 S *	9/2019	Legras	.....	D21/370				
D858,642 S *	9/2019	Legras	.....	D21/370				
D859,347 S *	9/2019	Kwon	.....	D14/138 AB				
D862,602 S	10/2019	Kariya						
D865,066 S	10/2019	Ortiz De Viveiros						
D865,873 S	11/2019	Lewis						
D866,666 S	11/2019	Ditton						
D866,667 S	11/2019	Stair						
D866,668 S	11/2019	Ditton						
D868,165 S	11/2019	Ortiz De Viveiros						
D870,818 S	12/2019	Curbbun						
D870,820 S	12/2019	Urban						
D871,506 S	12/2019	Castro						
D871,507 S	12/2019	Urban						
D872,190 S	1/2020	Zedell, Jr.						
D875,091 S *	2/2020	Kwon	.....	D14/341				
10,580,252 B2	3/2020	Whelan						
D880,605 S	4/2020	Bussey						
D880,606 S	4/2020	Glenn, II						
D880,608 S	4/2020	Glenn, II						
D880,610 S	4/2020	Glenn, II						
D880,611 S	4/2020	Glenn, II						
D880,612 S	4/2020	Bernard						
D880,613 S	4/2020	Bernard						

OTHER PUBLICATIONS

Office Action dated Jul. 10, 2020 for U.S. Appl. No. 29/684,900 (pp. 1-10).  
Office Action dated Jul. 10, 2020 for U.S. Appl. No. 29/684,938 (pp. 1-13).  
Notice of Allowance dated Aug. 5, 2020 for U.S. Appl. No. 29/678,496 (pp. 1-7).  
Office Action dated Jun. 1, 2020 for U.S. Appl. No. 29/684,806 (pp. 1-9).  
Office Action dated Jun. 1, 2020 for U.S. Appl. No. 29/684,807 (pp. 1-8).  
Office Action dated Jun. 1, 2020 for U.S. Appl. No. 29/684,809 (pp. 1-7).  
Office Action dated Jun. 1, 2020 for U.S. Appl. No. 29/684,811 (pp. 1-7).  
Office Action dated Jun. 12, 2020 for U.S. Appl. No. 29/684,912 (pp. 1-10).  
Corrected Notice of Allowability dated Aug. 17, 2020 for U.S. Appl. No. 29/678,496 (pp. 1-4).  
Office Action dated Jun. 1, 2020 for U.S. Appl. No. 29/684,808 (pp. 1-9).  
Office Action dated Jun. 1, 2020 for U.S. Appl. No. 29/684,812 (pp. 1-9).  
Office Action dated Jun. 1, 2020 for U.S. Appl. No. 29/684,836 (pp. 1-9).  
Office Action dated Jun. 1, 2020 for U.S. Appl. No. 29/684,844 (pp. 1-9).  
Office Action dated Jun. 1, 2020 for U.S. Appl. No. 29/684,849 (pp. 1-9).  
Office Action dated Jun. 5, 2020 for U.S. Appl. No. 29/684,847 (pp. 1-9).  
Office Action dated Jun. 12, 2020 for U.S. Appl. No. 29/684,810 (pp. 1-10).  
Office Action dated Jun. 12, 2020 for U.S. Appl. No. 29/684,814 (pp. 1-10).  
Office Action dated Jun. 12, 2020 for U.S. Appl. No. 29/684,817 (pp. 1-11).

Office Action dated June 12, 2020 for U.S. Appl. No. 29/684,838 (pp. 1-11).  
Office Action dated June 12, 2020 for U.S. Appl. No. 29/684,842 (pp. 1-11).  
Office Action dated June 12, 2020 for U.S. Appl. No. 29/684,883 (pp. 1-8).  
Office Action dated June 12, 2020 for U.S. Appl. No. 29/684,890 (pp. 1-9).  
Office Action dated June 12, 2020 for U.S. Appl. No. 29/684,891 (pp. 1-9).  
Office Action dated June 12, 2020 for U.S. Appl. No. 29/684,894 (pp. 1-10).  
Office Action dated June 12, 2020 for U.S. Appl. No. 29/684,899 (pp. 1-9).  
Office Action dated June 12, 2020 for U.S. Appl. No. 29/684,915 (pp. 1-10).  
Office Action dated June 12, 2020 for U.S. Appl. No. 29/684,922 (pp. 1-10).  
Office Action dated June 12, 2020 for U.S. Appl. No. 29/684,925 (pp. 1-10).  
Office Action dated June 12, 2020 for U.S. Appl. No. 29/684,929 (pp. 1-10).  
Office Action dated Jun. 12, 2020 for U.S. Appl. No. 29/684,934 (pp. 1-10).  
Office Action dated Jun. 12, 2020 for U.S. Appl. No. 29/684,936 (pp. 1-10).  
Office Action dated Jun. 12, 2020 for U.S. Appl. No. 29/684,941 (pp. 1-12).

\* cited by examiner

*Primary Examiner* — Ryan Harvey  
(74) *Attorney, Agent, or Firm* — Armstrong Teasdale LLP

(57) **CLAIM**

We claim the ornamental design for a gaming machine, as shown and described.

**DESCRIPTION**

FIG. 1 is a front perspective view of a gaming machine showing our new design;

FIG. 2 is a front view of the gaming machine shown in FIG. 1;  
FIG. 3 is a back view of the gaming machine shown in FIG. 1;  
FIG. 4 is a right side view of the gaming machine shown in FIG. 1;  
FIG. 5 is a left side view of the gaming machine shown in FIG. 1;  
FIG. 6 is a top view of the gaming machine shown in FIG. 1;  
FIG. 7 is a bottom view of the gaming machine shown in FIG. 1;  
FIG. 8 is a front perspective view of a gaming machine showing an alternative embodiment of our new design;  
FIG. 9 is a front view of the gaming machine shown in FIG. 8;  
FIG. 10 is a front perspective view of a gaming machine showing a further embodiment of our new design;  
FIG. 11 is a front view of the gaming machine shown in FIG. 10;  
FIG. 12 is a back view of the gaming machine shown in FIG. 10;  
FIG. 13 is a right side view of the gaming machine shown in FIG. 10;  
FIG. 14 is a left side view of the gaming machine shown in FIG. 10;  
FIG. 15 is a top view of the gaming machine shown in FIG. 10;  
FIG. 16 is a bottom view of the gaming machine shown in FIG. 10;  
FIG. 17 is a front perspective view of a gaming machine showing another alternative embodiment of our new design; and,  
FIG. 18 is a front view of the gaming machine shown in FIG. 17.  
The broken line showing of portions of the gaming machine depicts environment and forms no part of the claimed design.

**1 Claim, 18 Drawing Sheets**

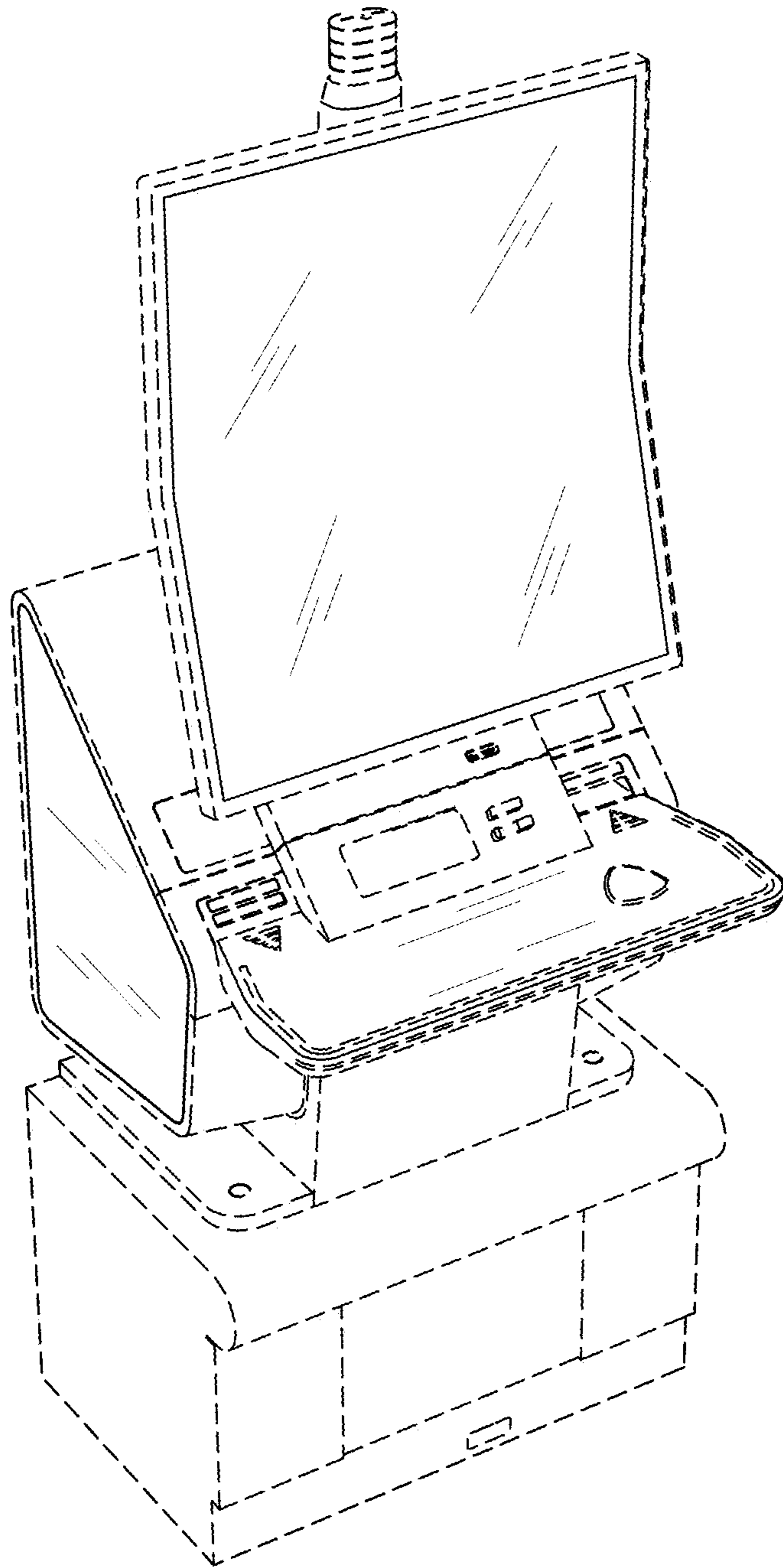

FIG. 1

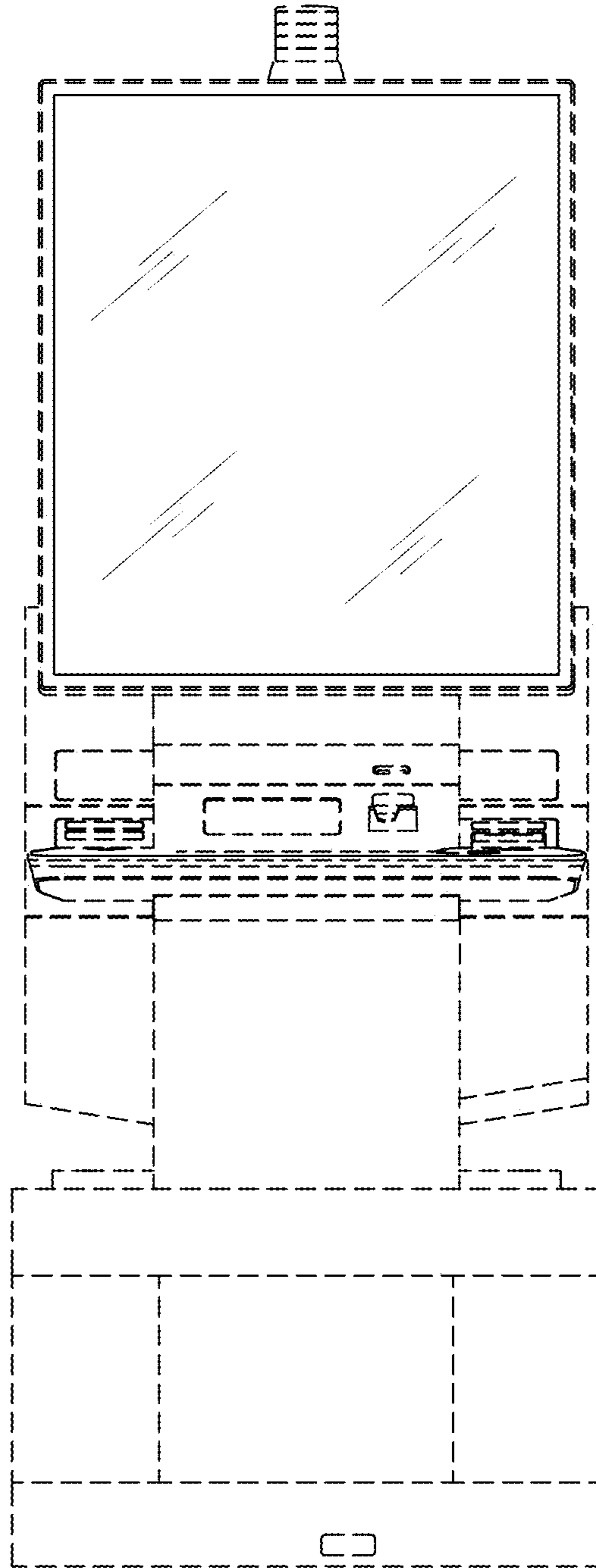

FIG. 2

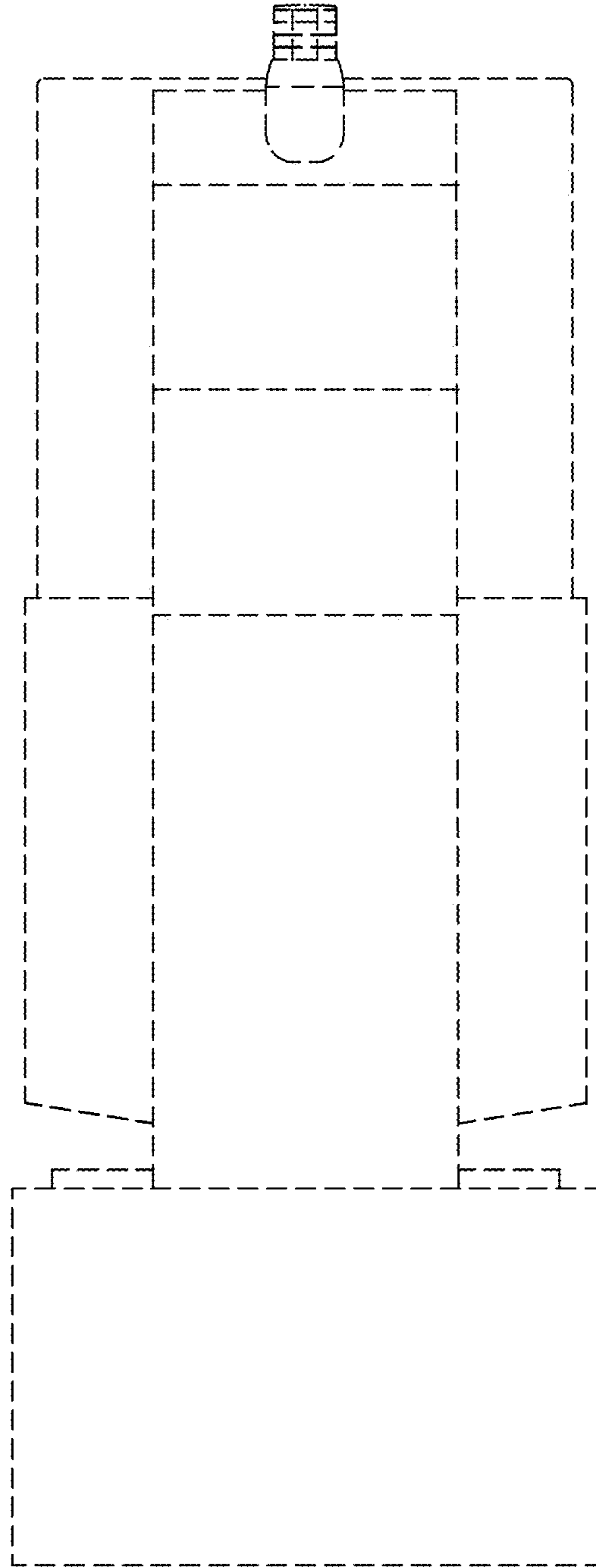

FIG. 3

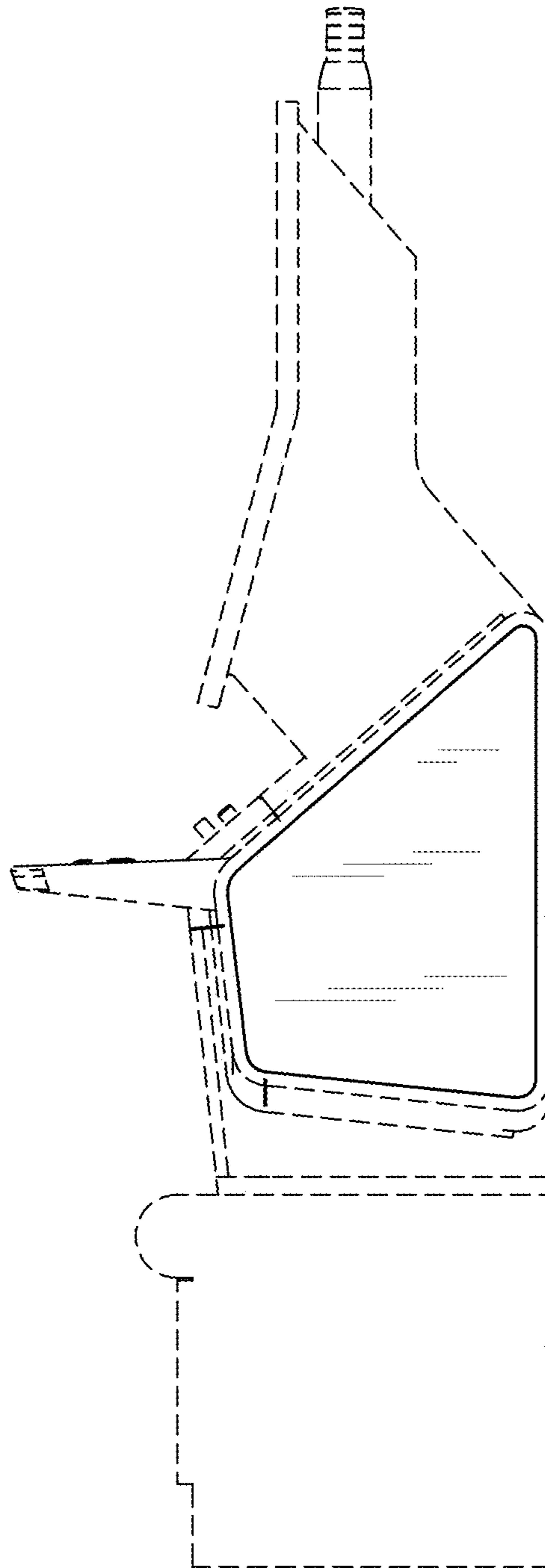

FIG. 4

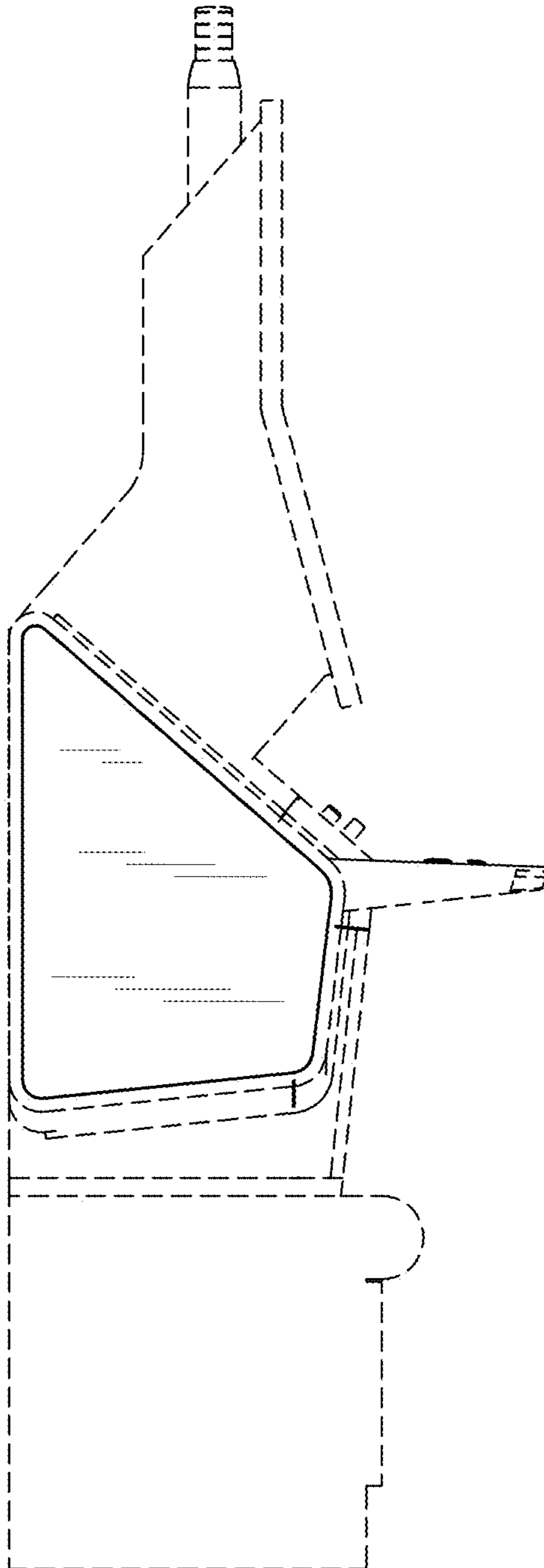

FIG. 5



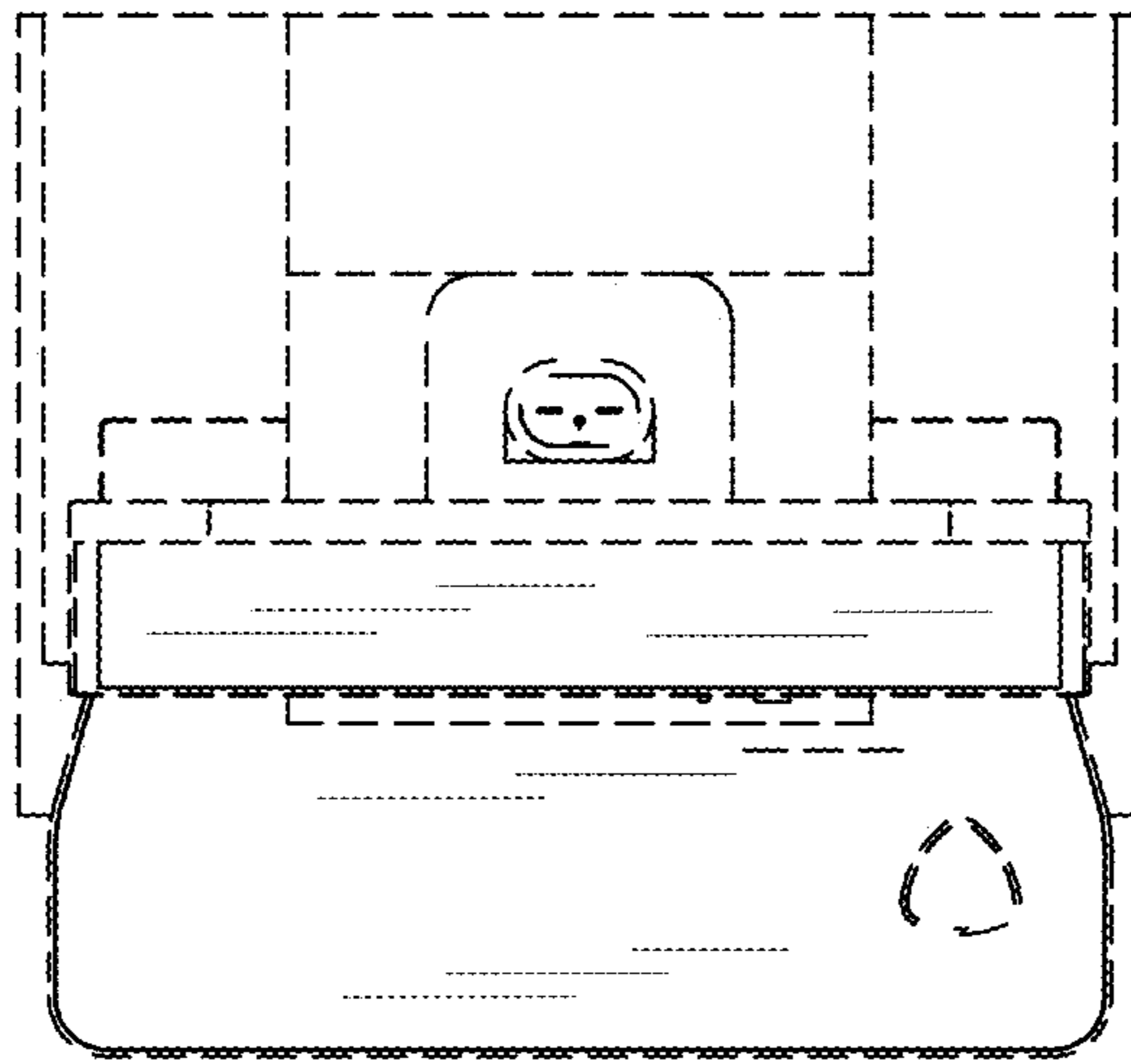

FIG. 6

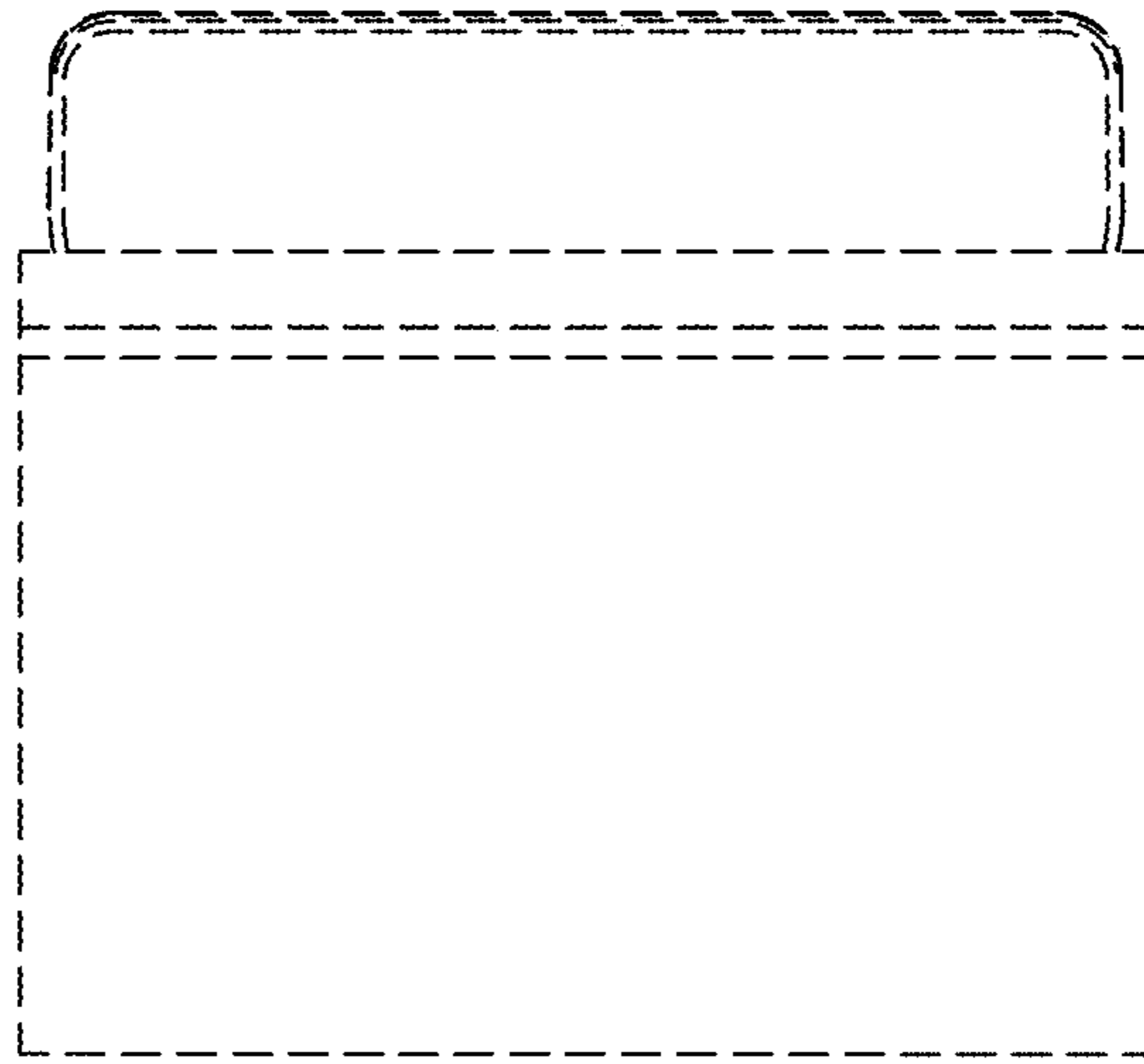

FIG. 7

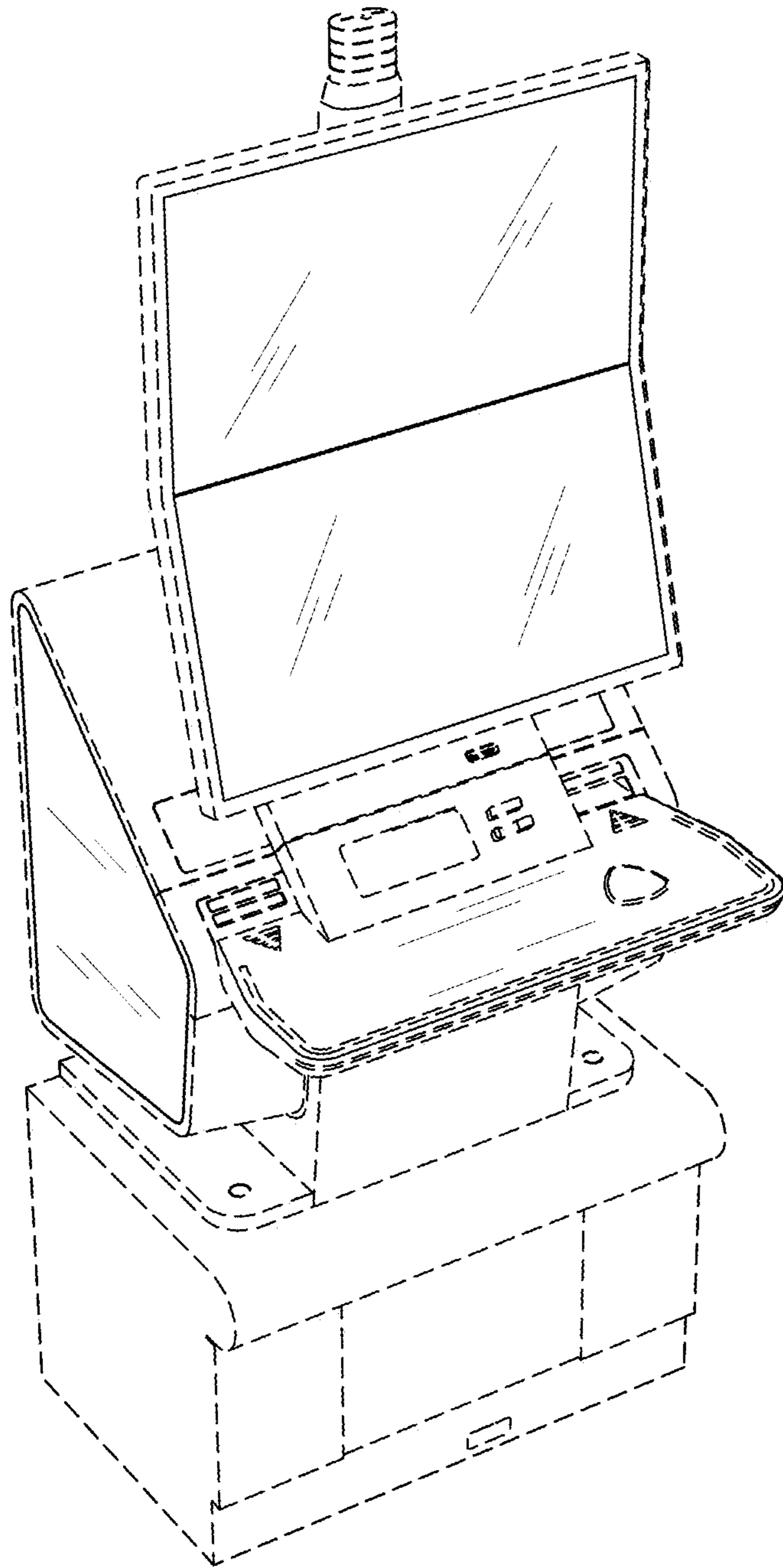

FIG. 8

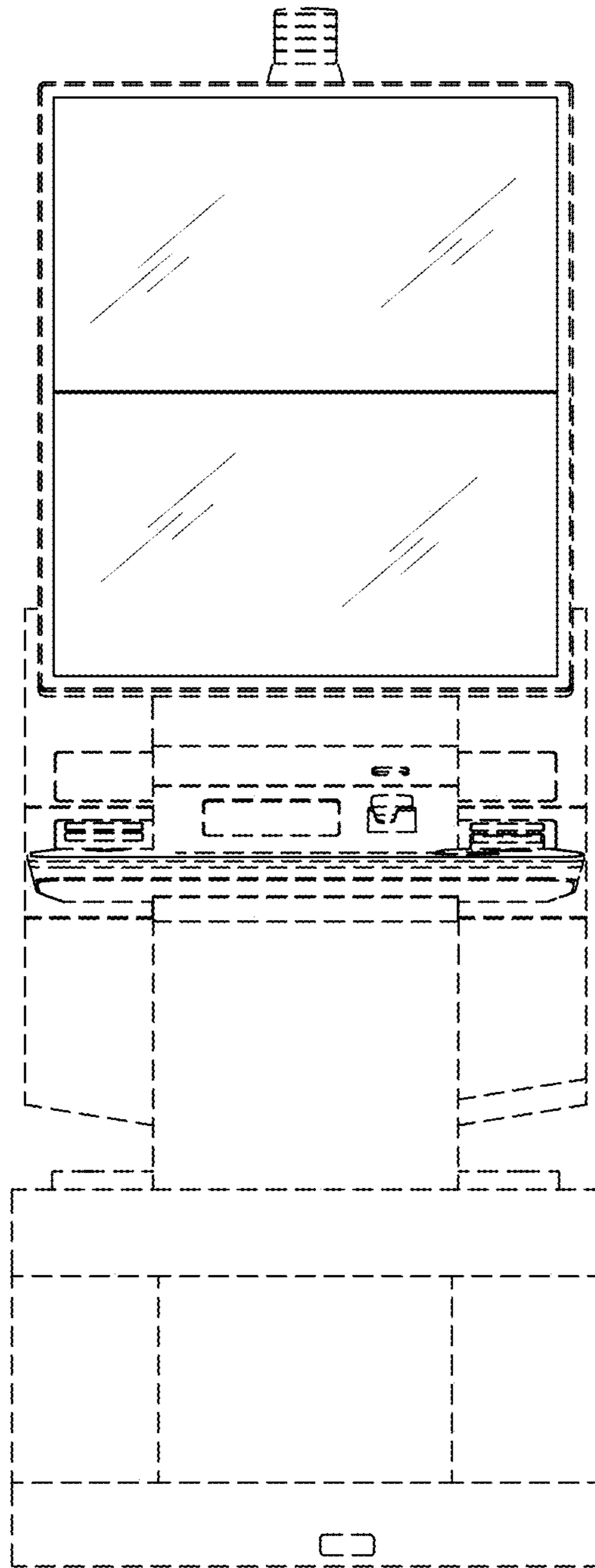

FIG. 9

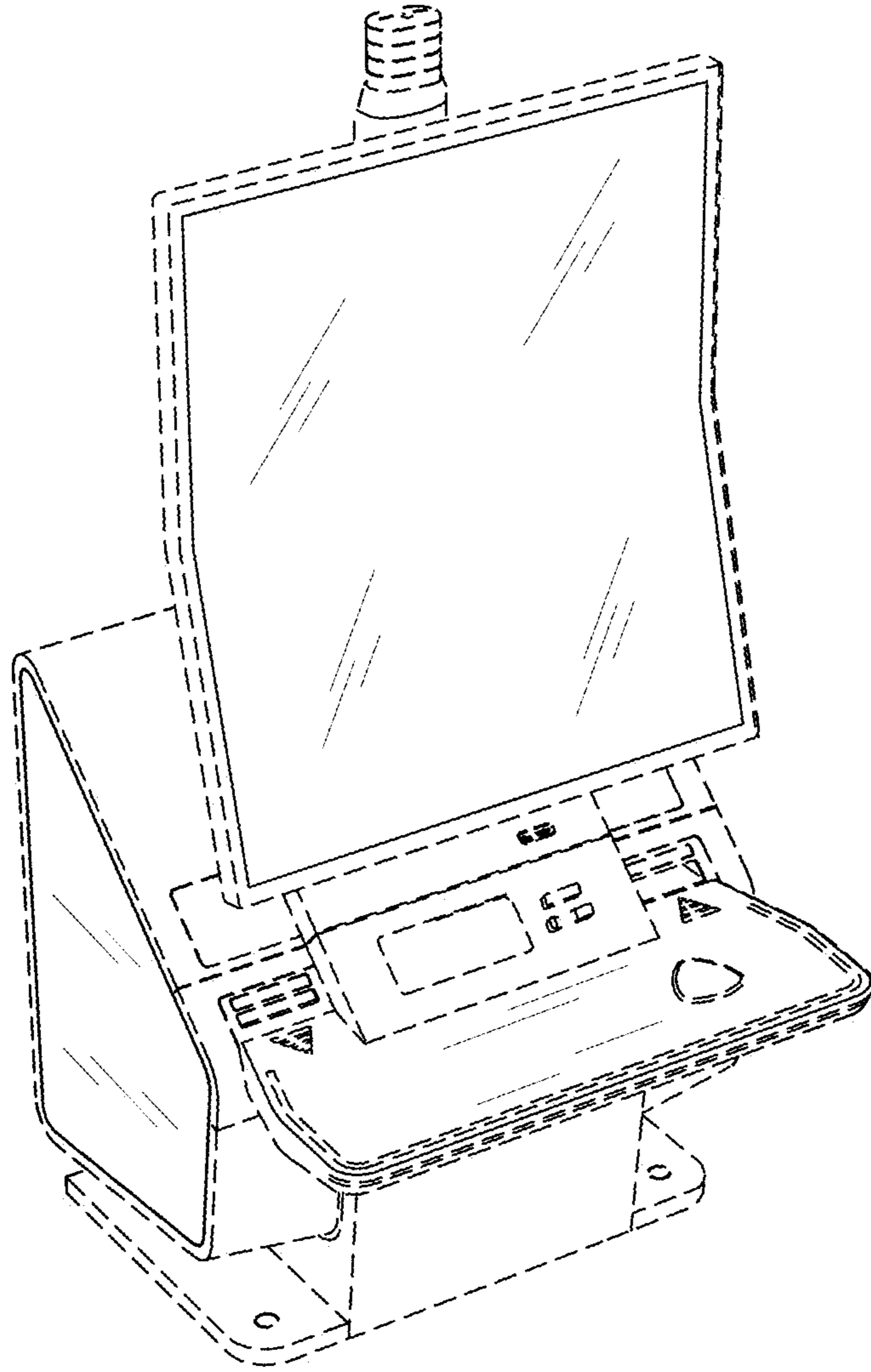

FIG. 10

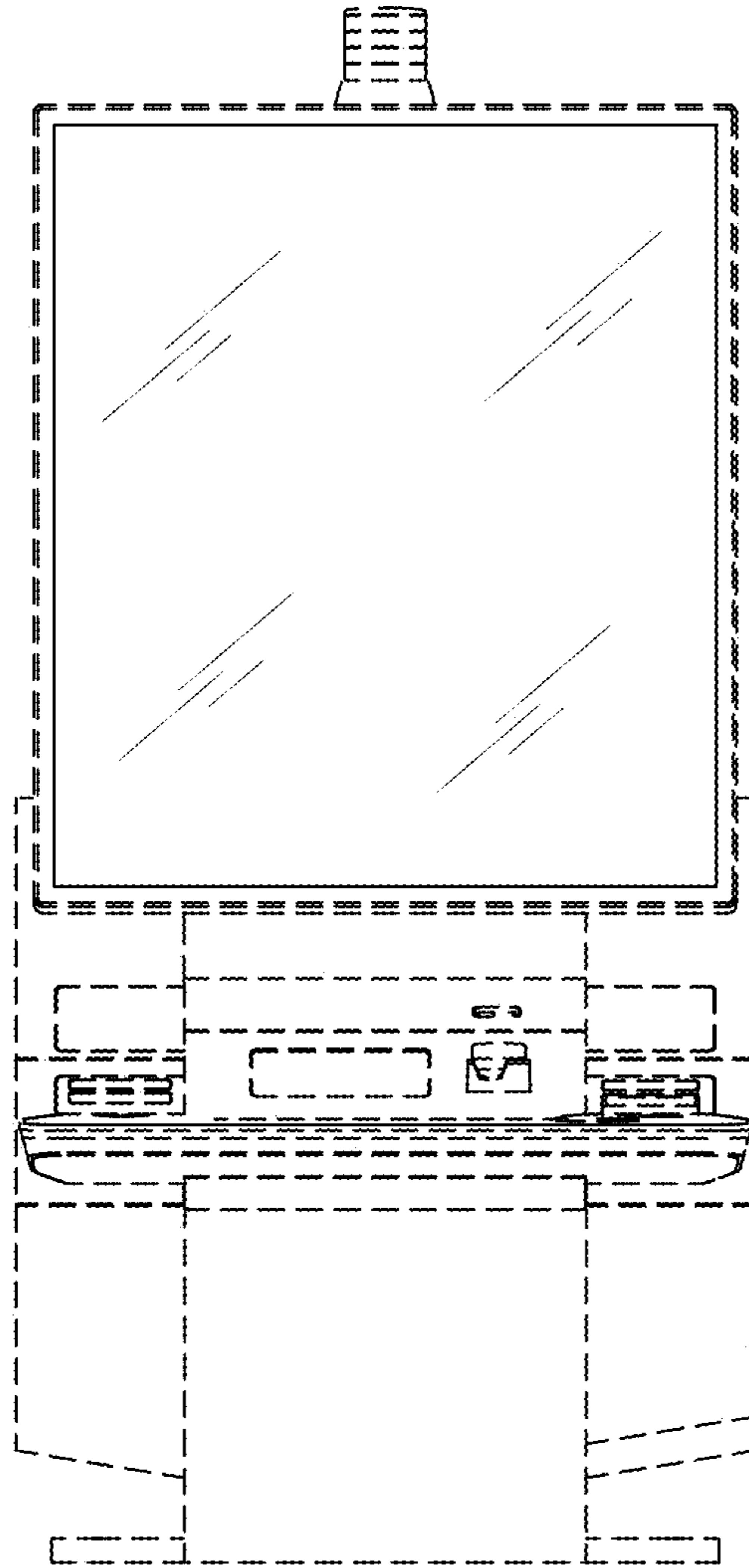

FIG. 11

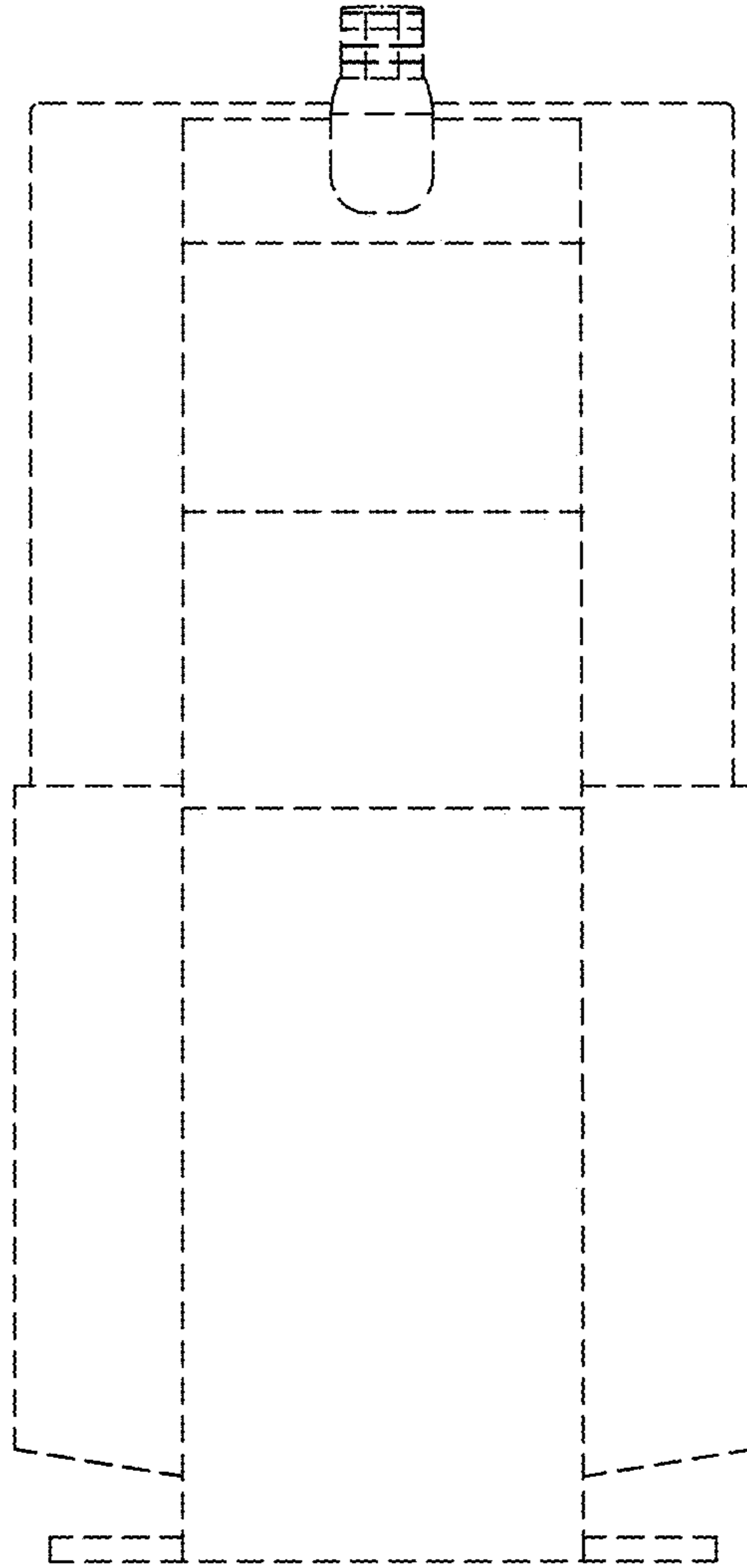

FIG. 12

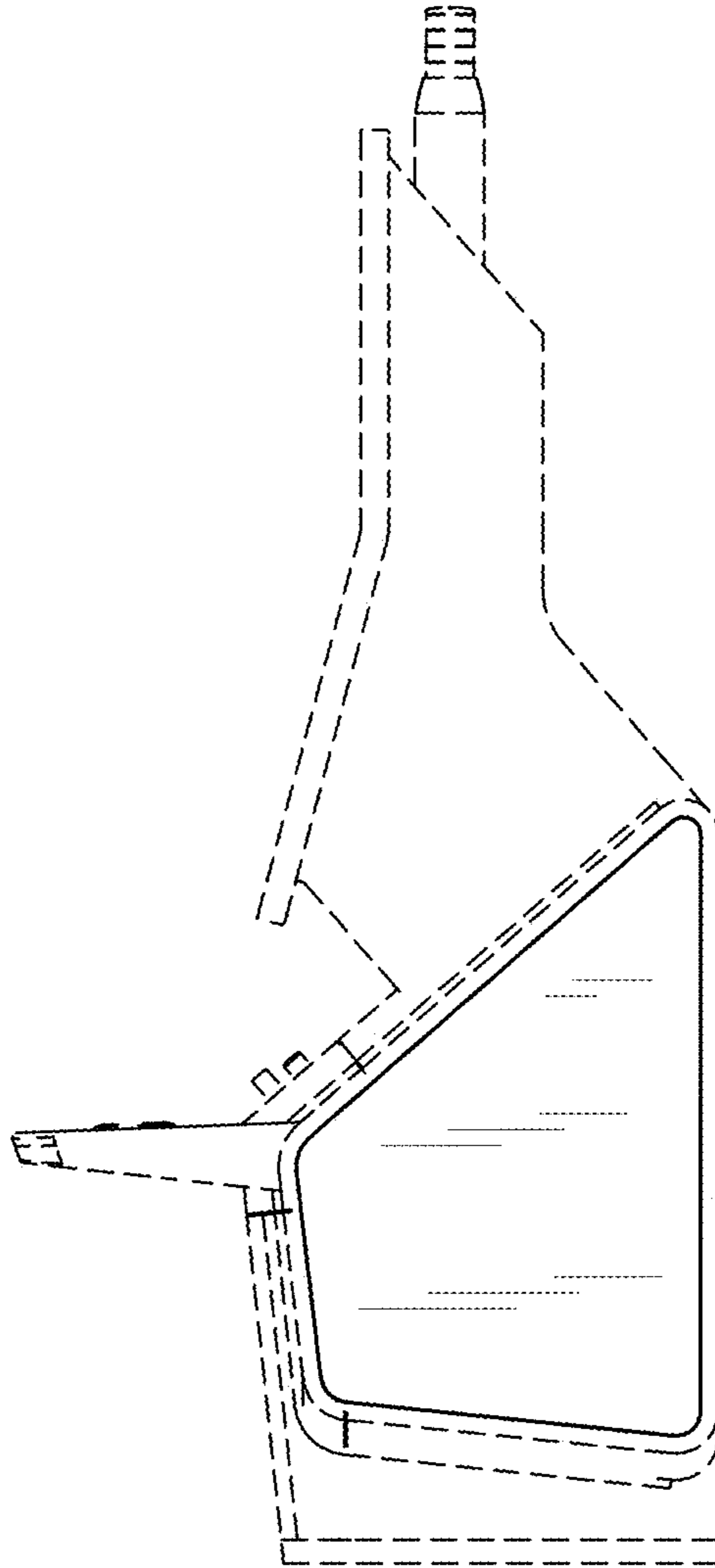

FIG. 13



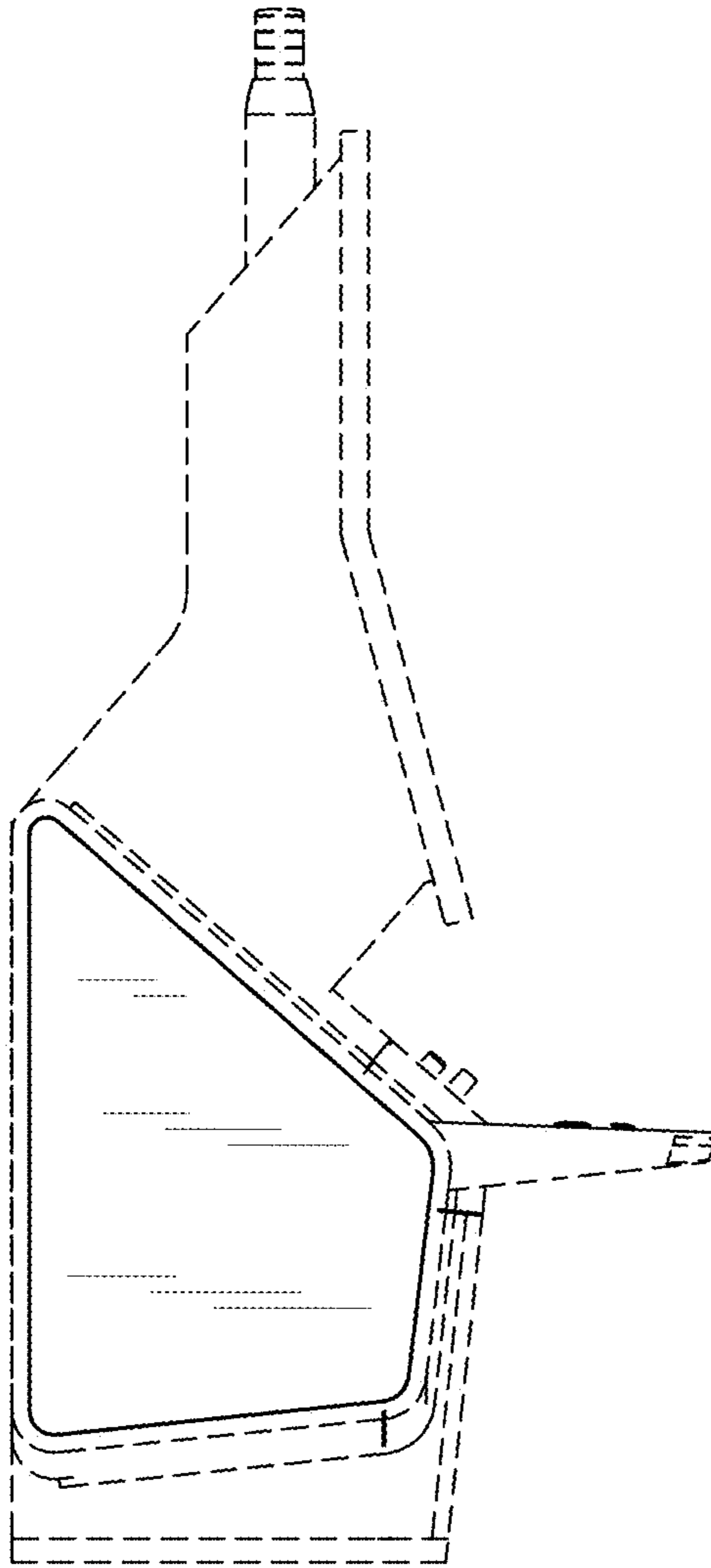

FIG. 14

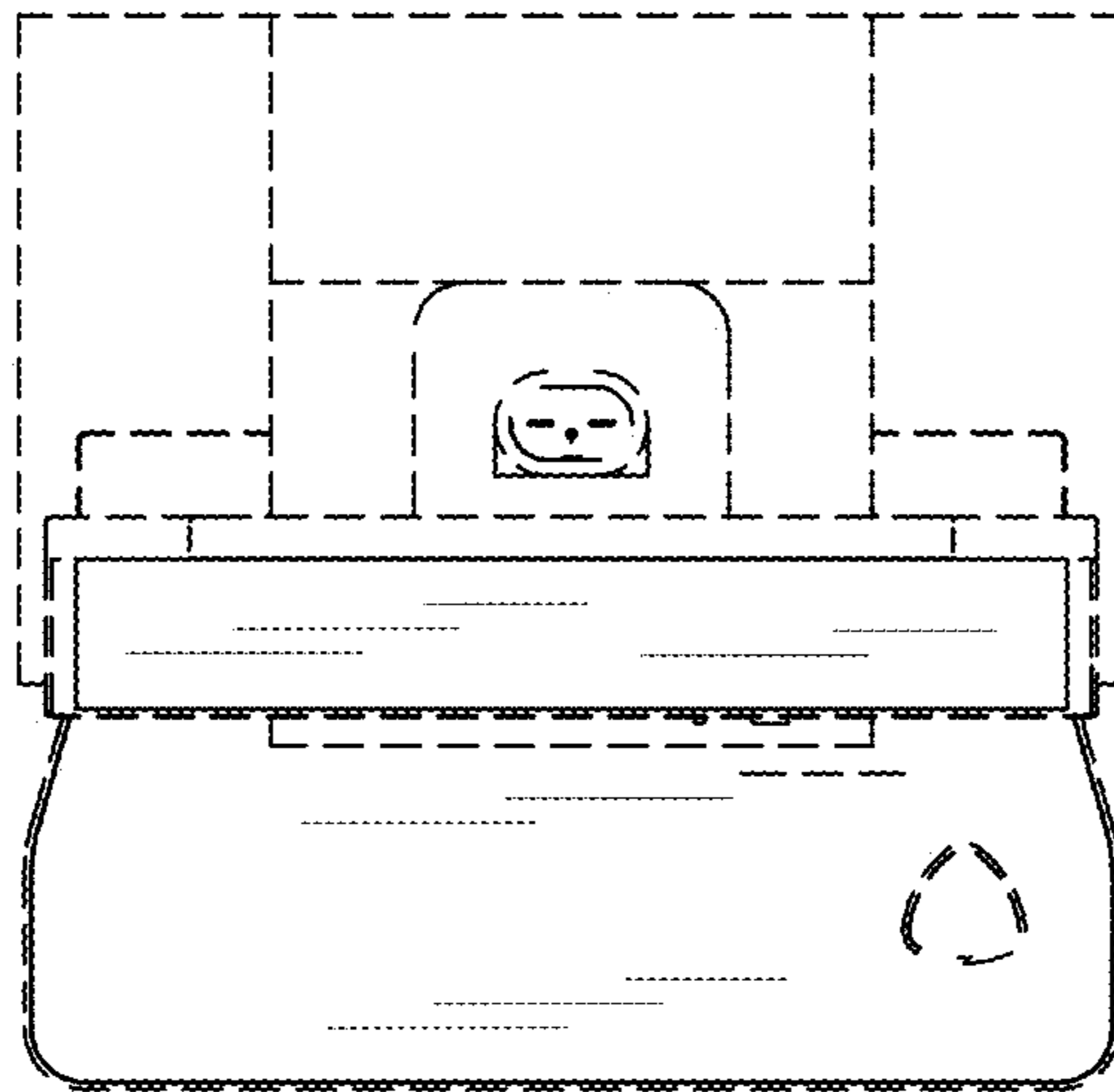

FIG. 15

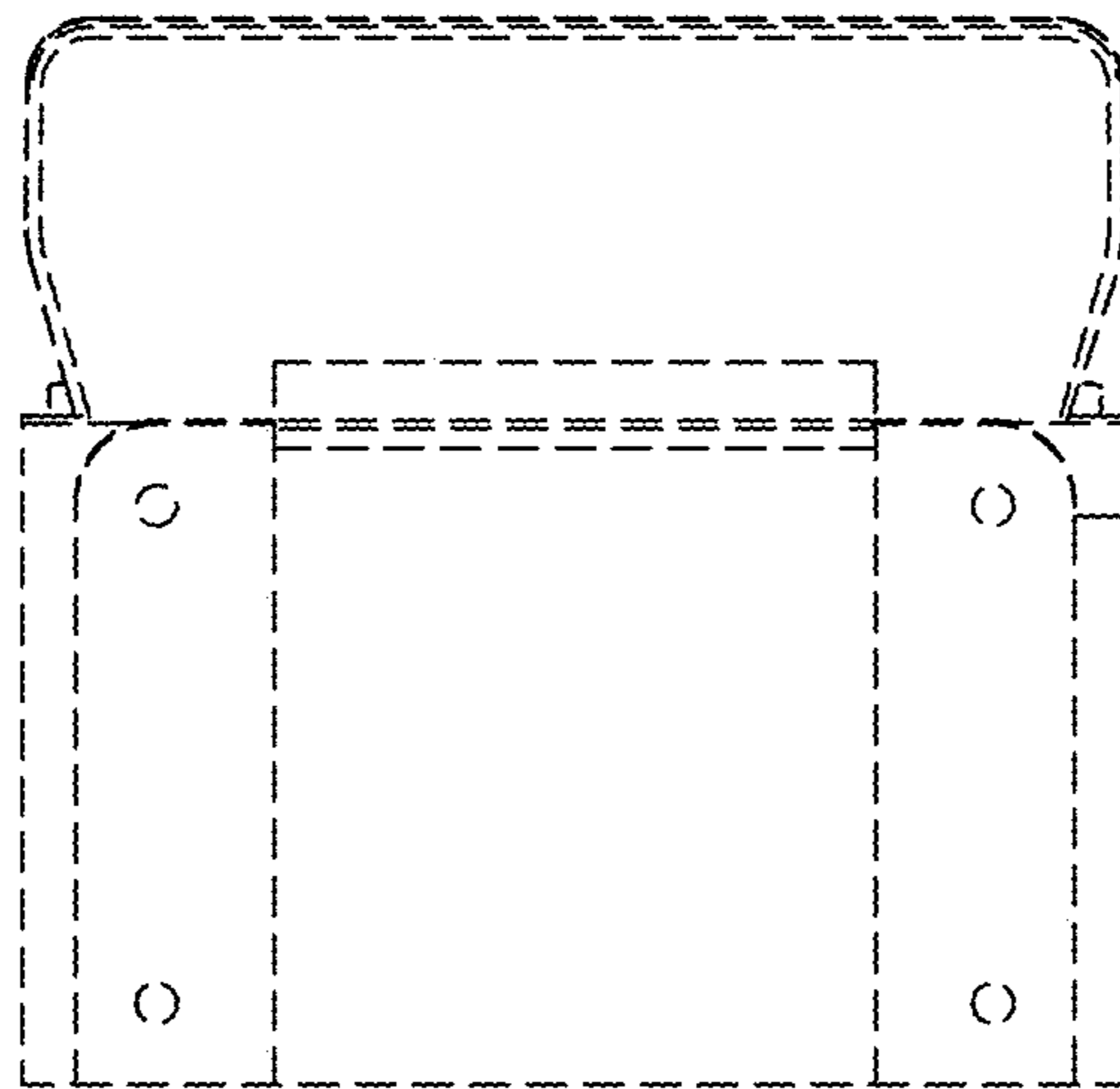

FIG. 16

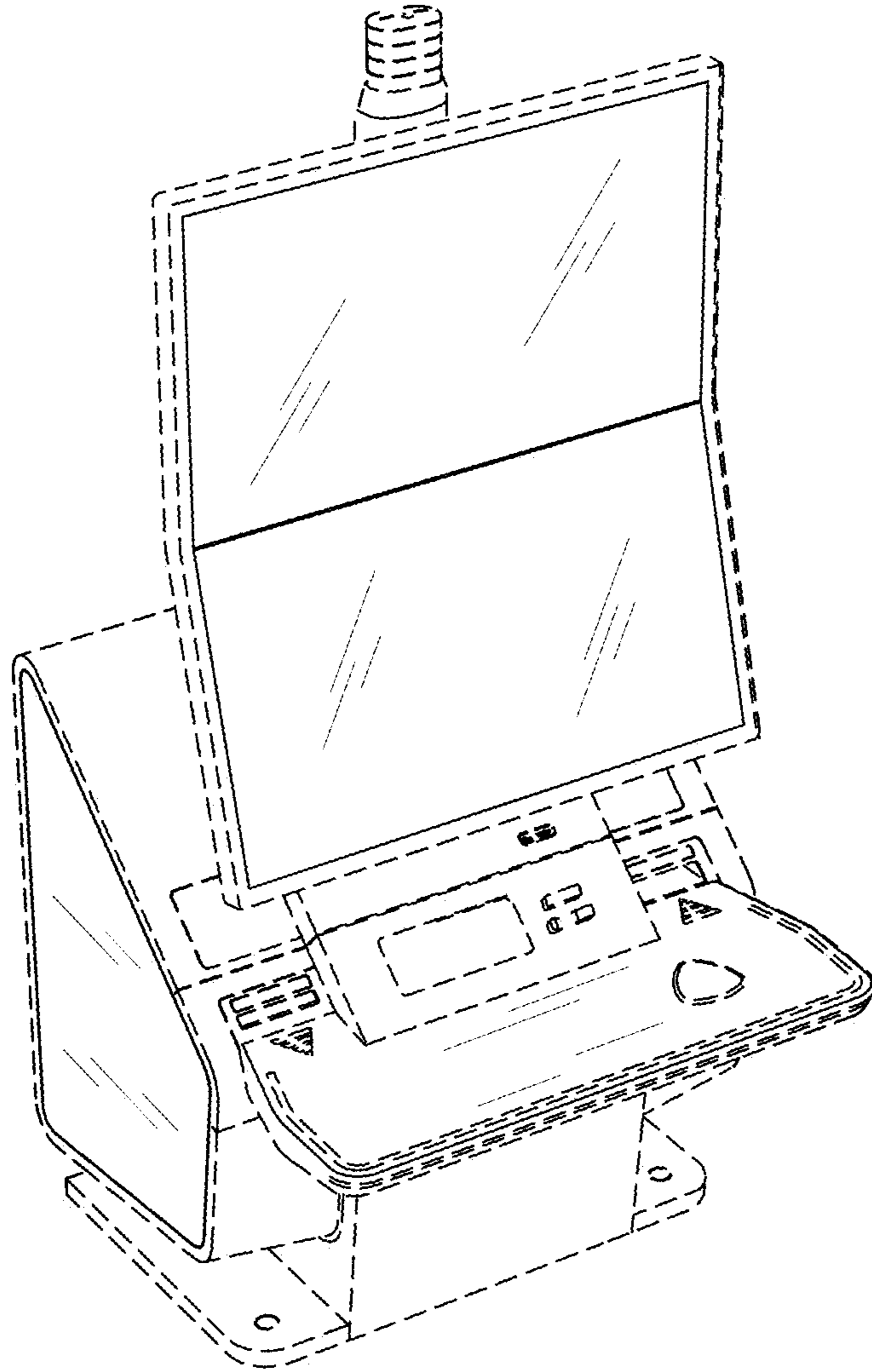

FIG. 17

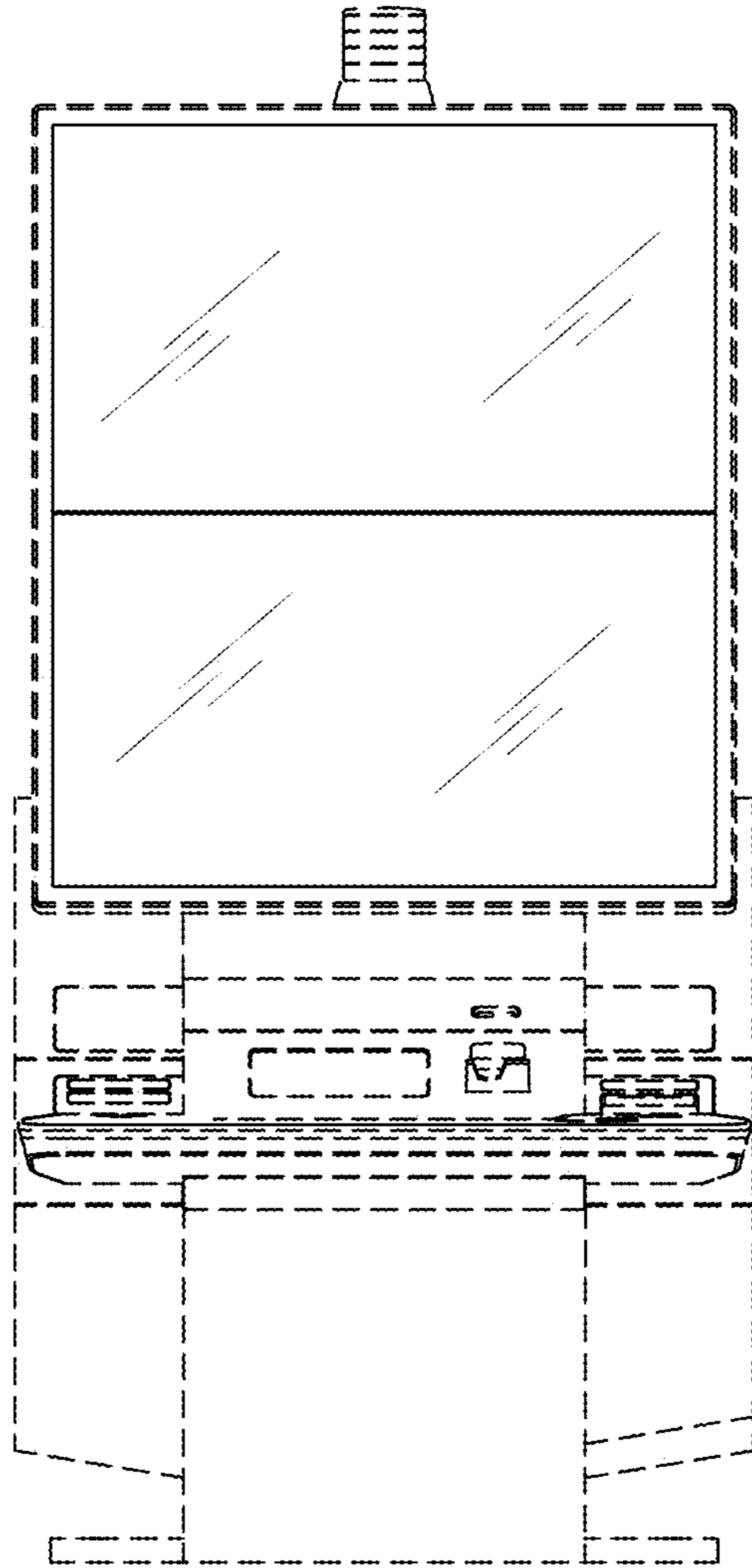

FIG. 18