



US00D907112S

(12) **United States Design Patent** (10) **Patent No.:** **US D907,112 S**
Takeuchi et al. (45) **Date of Patent:** **** Jan. 5, 2021**

(54) **PROCESS CARTRIDGE FOR IMAGE FORMING APPARATUS**

(71) Applicant: **CANON KABUSHIKI KAISHA**,
Tokyo (JP)

(72) Inventors: **Toshiaki Takeuchi**, Shizuoka-ken (JP);
Yuuki Nakamura, Shizuoka-ken (JP)

(73) Assignee: **Canon Kabushiki Kaisha**, Tokyo (JP)

(**) Term: **15 Years**

(21) Appl. No.: **29/672,363**

(22) Filed: **Dec. 5, 2018**

Related U.S. Application Data

(62) Division of application No. 35/503,601, filed on Feb. 22, 2017 (U.S. filing date under 35 U.S.C. 384), and having an international filing date of Feb. 22, 2017, now Pat. No. Des. 855,105.

(30) **Foreign Application Priority Data**

Aug. 24, 2016 (JP) 2016-017940

(51) **LOC (13) Cl.** **16-03**

(52) **U.S. Cl.**
USPC **D18/40**

(58) **Field of Classification Search**
USPC D18/36, 40, 43, 44, 50, 56
CPC B41J 2/175; B41J 2/17563; G03G 15/00;
G03G 15/655; G03G 15/757; G03G
21/16; G03G 21/181
See application file for complete search history.

(56) **References Cited**

U.S. PATENT DOCUMENTS

D401,615 S * 11/1998 Goto D18/40
D489,753 S * 5/2004 Batori D18/40

D519,150 S * 4/2006 Kojima D18/40
D537,110 S * 2/2007 Nakata D18/40
D588,631 S * 3/2009 Nakamura D18/40
D638,056 S * 5/2011 Kanno D18/43
D638,057 S * 5/2011 Kanno D18/43
D639,335 S * 6/2011 Kanno D18/43
D639,846 S * 6/2011 Kanno D18/43
D657,413 S * 4/2012 Hashimoto D18/43
D718,379 S * 11/2014 Sakuma D18/43
D765,164 S * 8/2016 Park D18/43
D823,380 S * 7/2018 Uratani D18/43
D823,938 S * 7/2018 Uratani D18/43
D845,384 S * 4/2019 Oguma D18/43

FOREIGN PATENT DOCUMENTS

JP 2017107142 A 6/2017
JP 2017142473 A 8/2017

* cited by examiner

Primary Examiner — Mary Ann Calabrese
(74) *Attorney, Agent, or Firm* — Venable LLP

(57) **CLAIM**

The ornamental design for a process cartridge for image forming apparatus, as shown and described.

DESCRIPTION

FIG. 1 is a front view showing my new design.
FIG. 2 is a back view thereof.
FIG. 3 is a top view thereof.
FIG. 4 is a bottom view thereof.
FIG. 5 is a left side view thereof.
FIG. 6 is a right side view thereof.
FIG. 7 is a front perspective view thereof; and,
FIG. 8 is a back perspective view thereof.

1 Claim, 8 Drawing Sheets

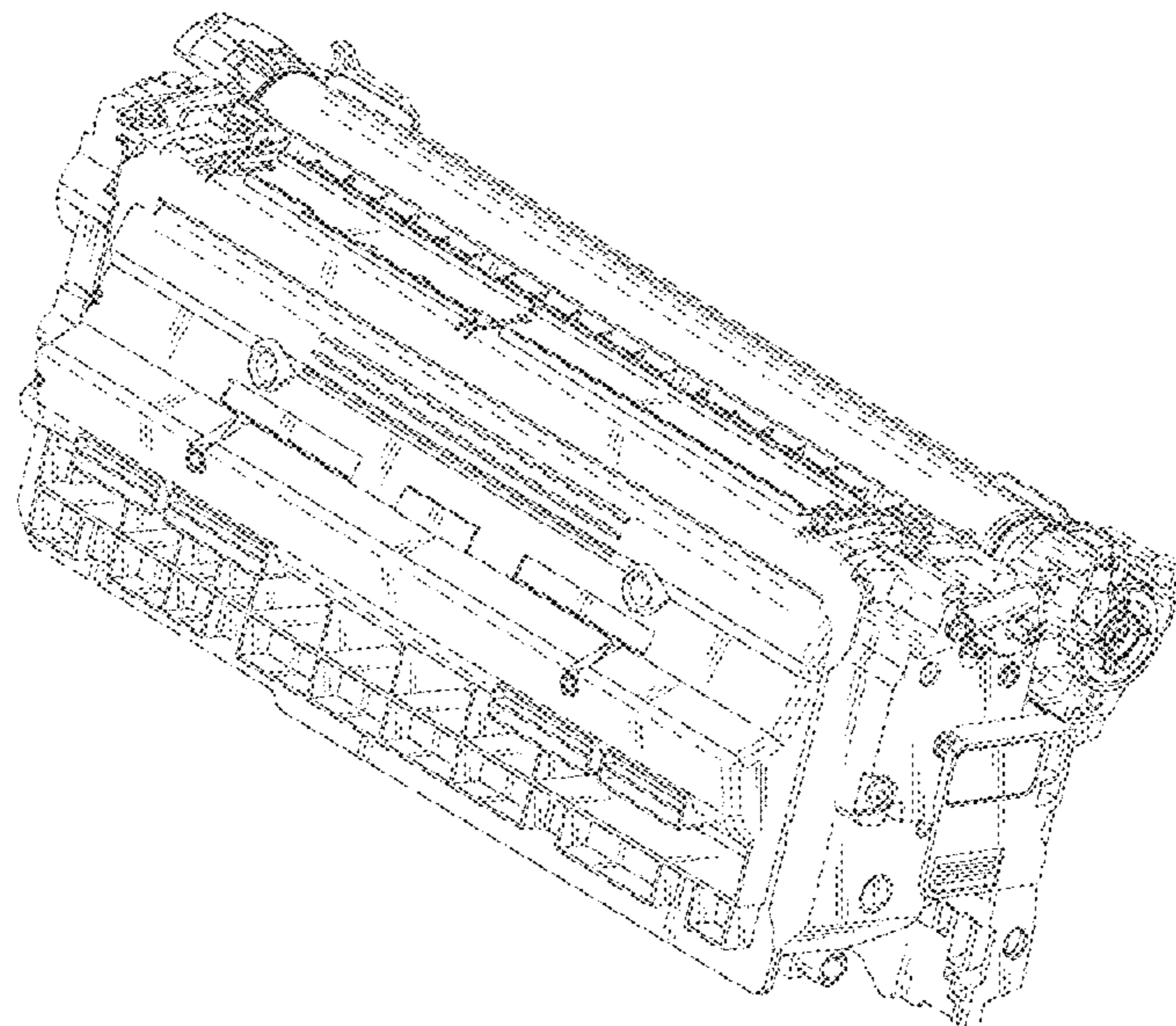

Fig. 1

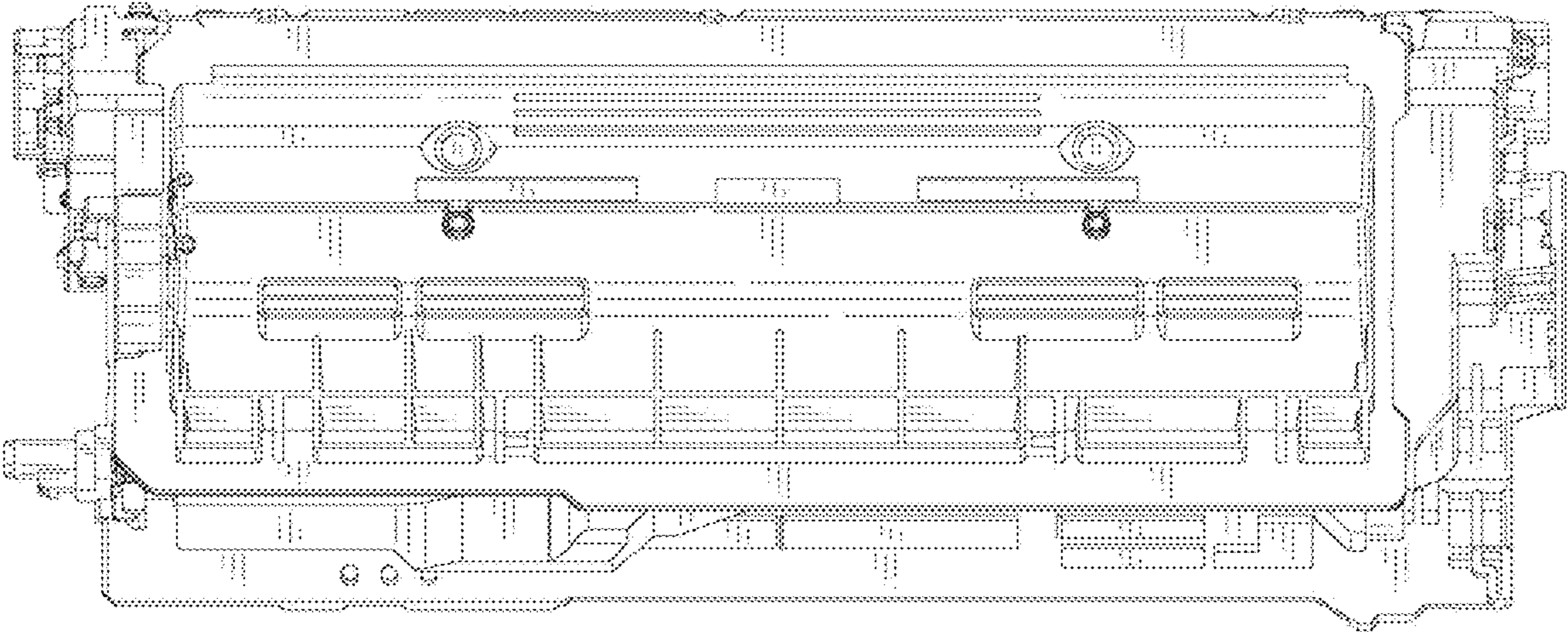

Fig. 2

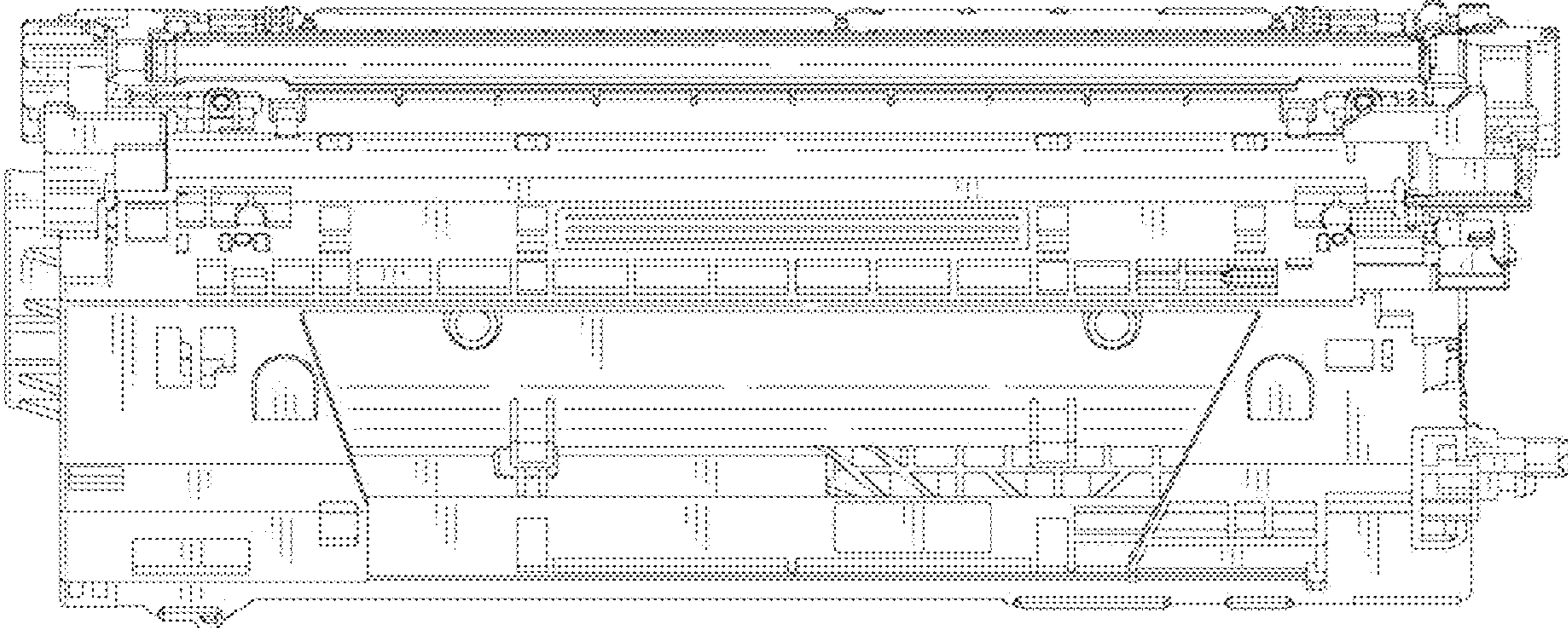

Fig. 3

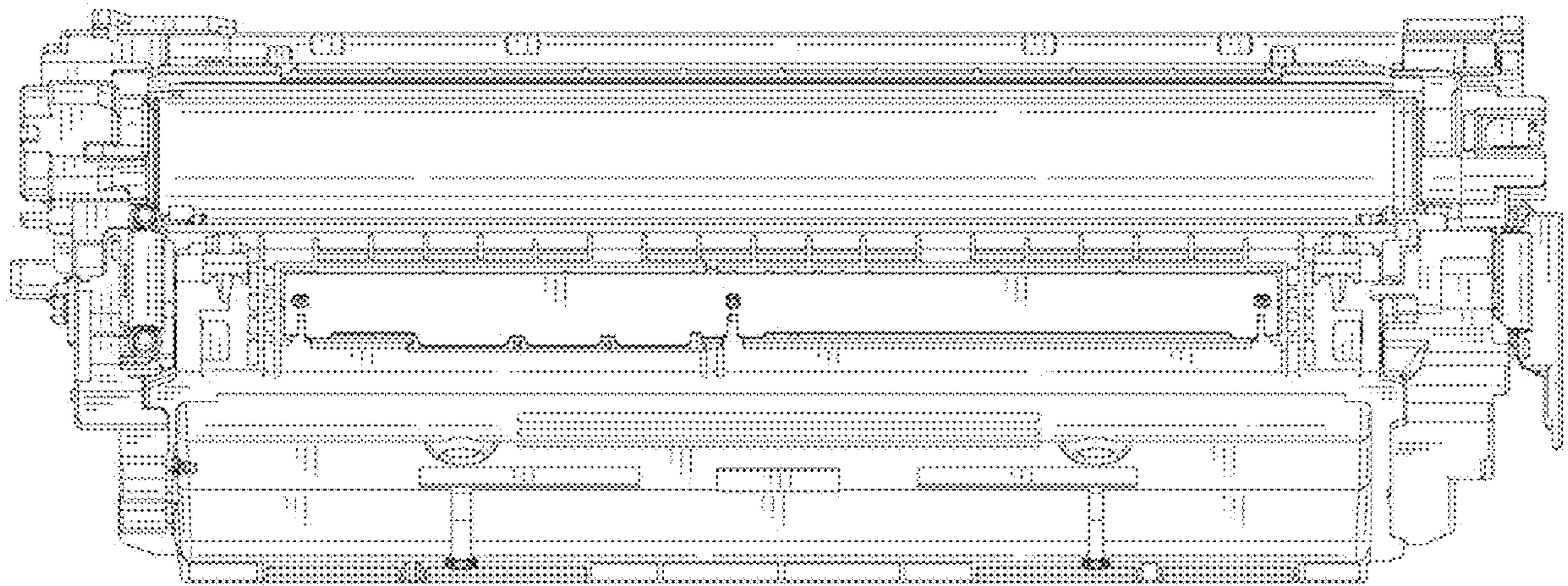

Fig. 4

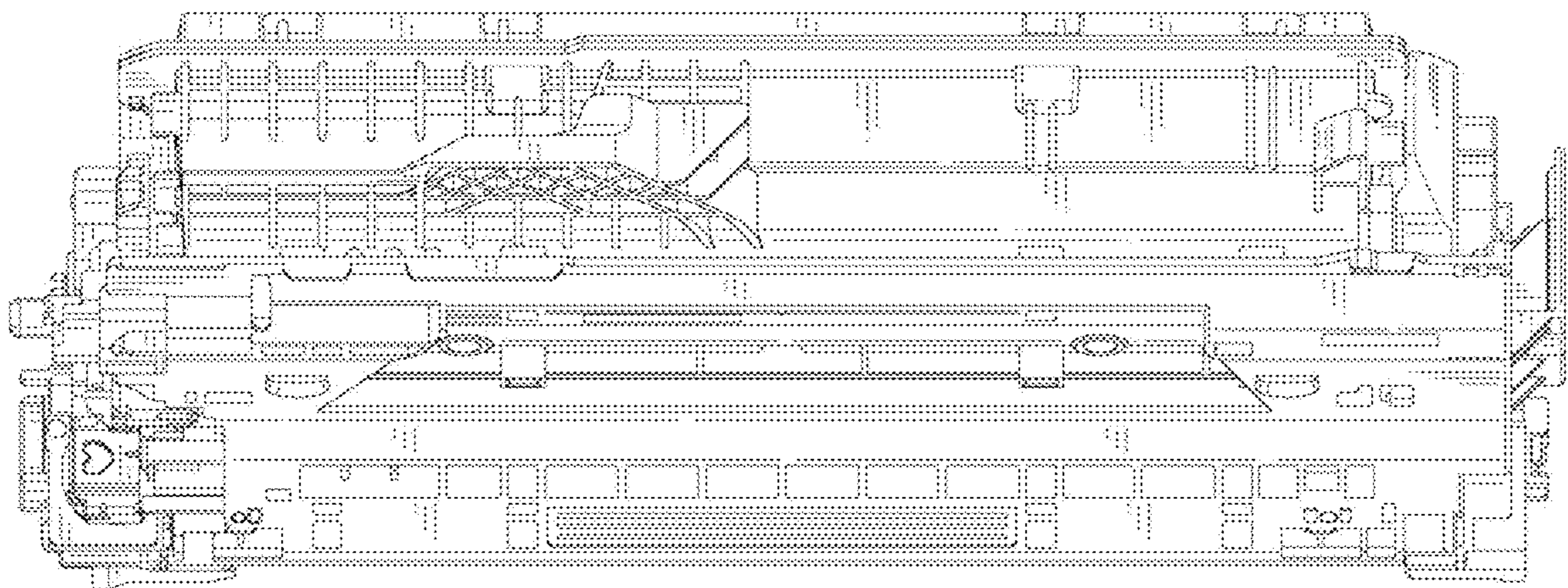

Fig. 5

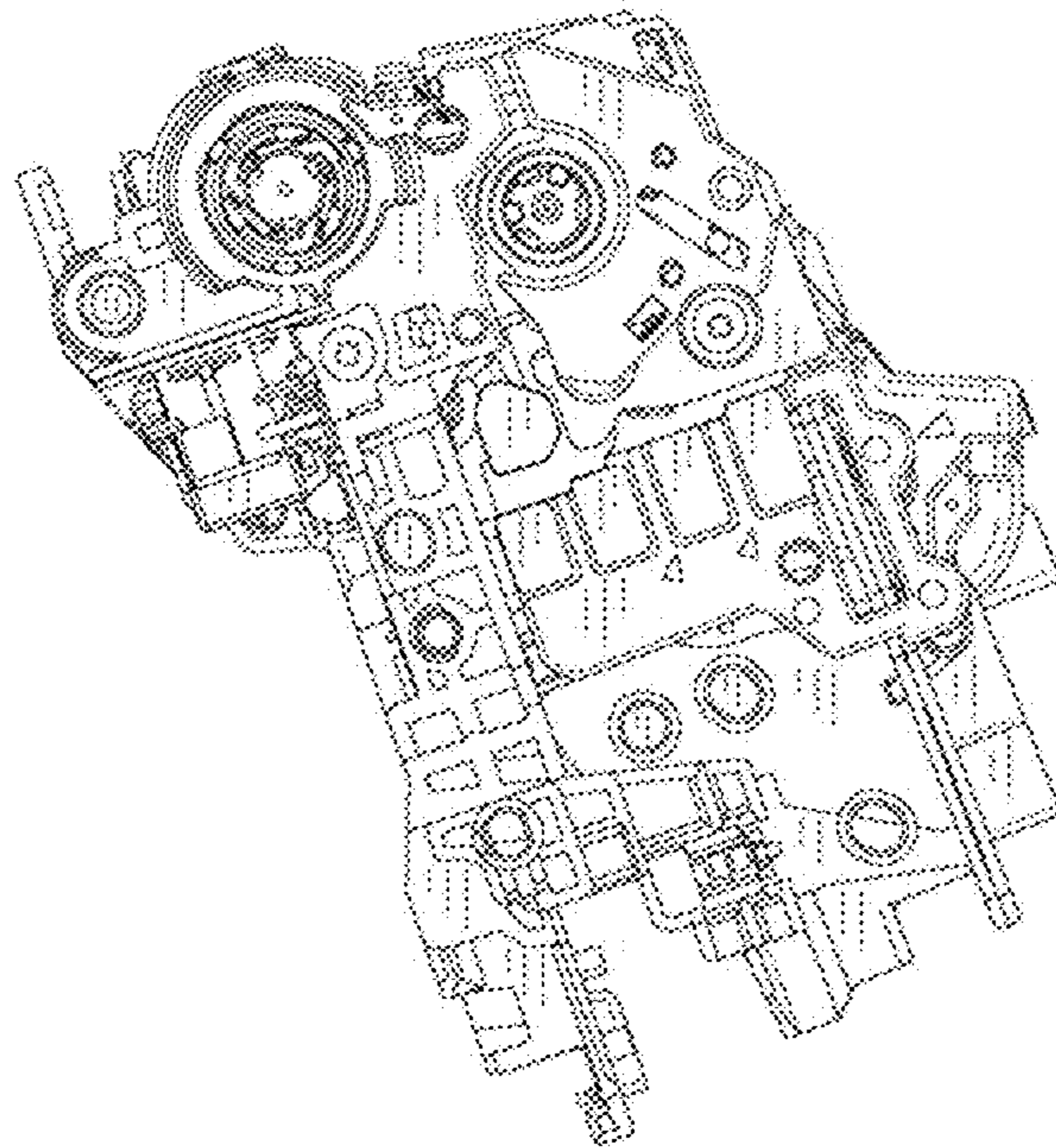

Fig. 6

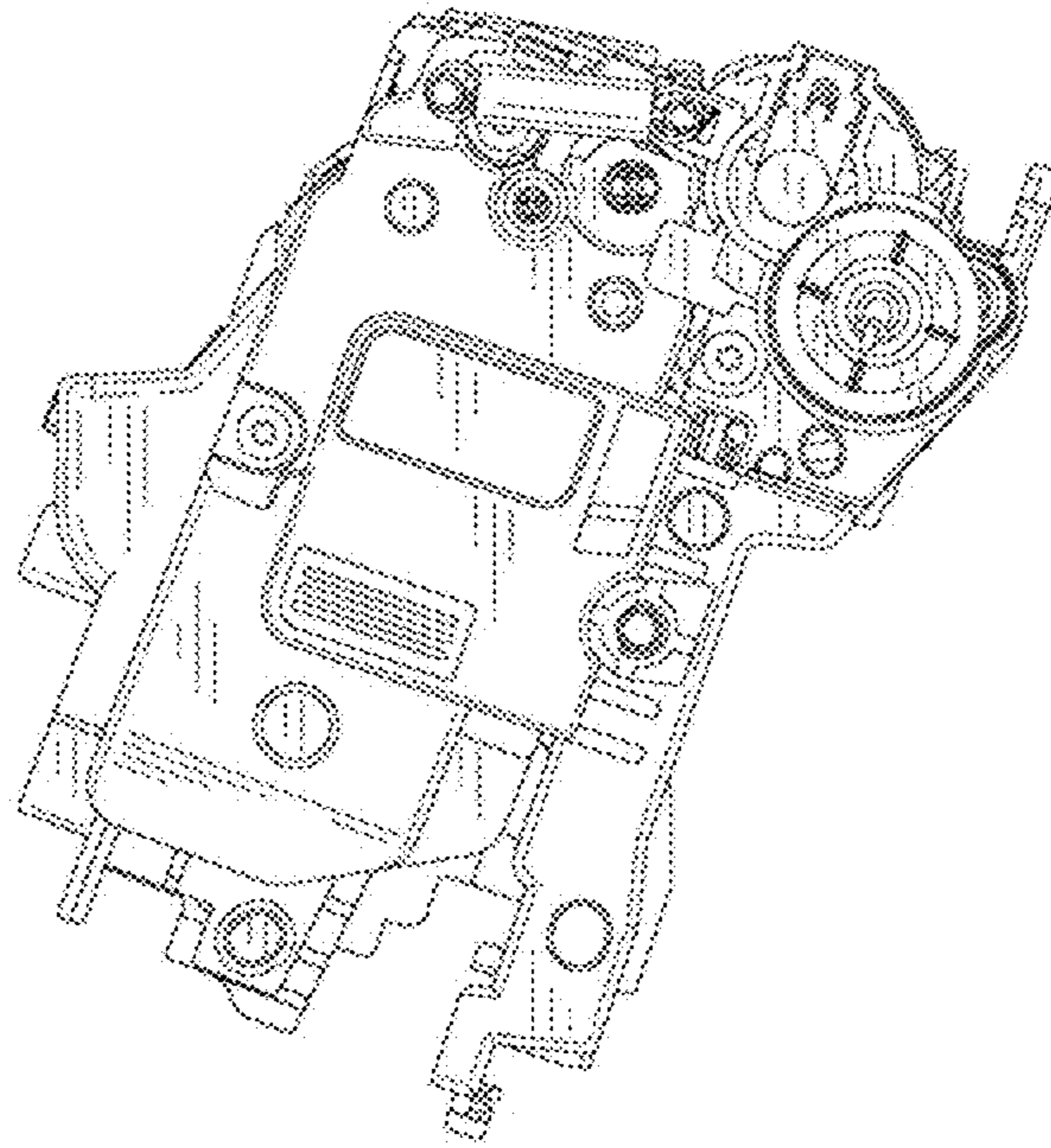

Fig. 8

