



US00D907081S

(12) **United States Design Patent** (10) **Patent No.:** **US D907,081 S**  
**Monteleone** (45) **Date of Patent:** **\*\* Jan. 5, 2021**

(54) **LAMINATING CARTRIDGE**

FOREIGN PATENT DOCUMENTS

(71) Applicant: **ACCO BRANDS CORPORATION**,  
Lake Zurich, IL (US)

DE 102008057006 A1 5/2010  
WO 2001/056787 A1 8/2001  
WO 2010/083729 A1 7/2010

(72) Inventor: **Andrew Monteleone**, Chicago, IL (US)

OTHER PUBLICATIONS

(73) Assignee: **ACCO Brands Corporation**, Lake  
Zurich, IL (US)

Xyron®, "ezLaminator Laminate Refill, 9"×60", Two Sided," <<https://www.amazon.com/Xyron-ezLaminator-Laminate-Refill-145612/dp/B000MK4SGU>> website accessed Sep. 9, 2018.

(\*\*) Term: **15 Years**

(Continued)

(21) Appl. No.: **29/715,947**

*Primary Examiner* — Patricia A Palasik

(22) Filed: **Dec. 5, 2019**

(74) *Attorney, Agent, or Firm* — Michael Best & Friedrich LLP

**Related U.S. Application Data**

(63) Continuation of application No. 29/668,057, filed on  
Oct. 26, 2018, now Pat. No. Des. 872,786.

(51) **LOC (13) Cl.** ..... **15-09**

(52) **U.S. Cl.**

USPC ..... **D15/145**

(58) **Field of Classification Search**

USPC ..... D15/145, 146; D18/12, 56

CPC ..... B62M 1/105; B32B 41/02; B32B 37/185;

B32B 2037/0061; Y10T 156/1741

See application file for complete search history.

(56) **References Cited**

**U.S. PATENT DOCUMENTS**

5,175,657 A 12/1992 Iftikar et al.  
5,232,538 A 8/1993 Liu  
5,807,461 A 9/1998 Hagstrom  
6,315,020 B1 11/2001 Seki  
6,386,772 B1 5/2002 Klinefelter et al.  
D466,151 S 11/2002 Shinada et al.  
D476,663 S 7/2003 Nonomura  
D477,326 S 7/2003 Nonomura  
6,805,179 B2 10/2004 Velasquez et al.  
6,810,934 B2 11/2004 Sasaki et al.  
6,832,866 B2 12/2004 Klinefelter et al.

(Continued)

(57) **CLAIM**

I claim the ornamental design for a laminating cartridge, as shown and described.

**DESCRIPTION**

FIG. 1 is a front perspective view of a laminating cartridge embodying the present invention.

FIG. 2 is a front view of the laminating cartridge of FIG. 1.

FIG. 3 is a rear view of the laminating cartridge of FIG. 1.

FIG. 4 is right side view of the laminating cartridge of FIG. 1.

FIG. 5 is a left side view of the laminating cartridge of FIG. 1.

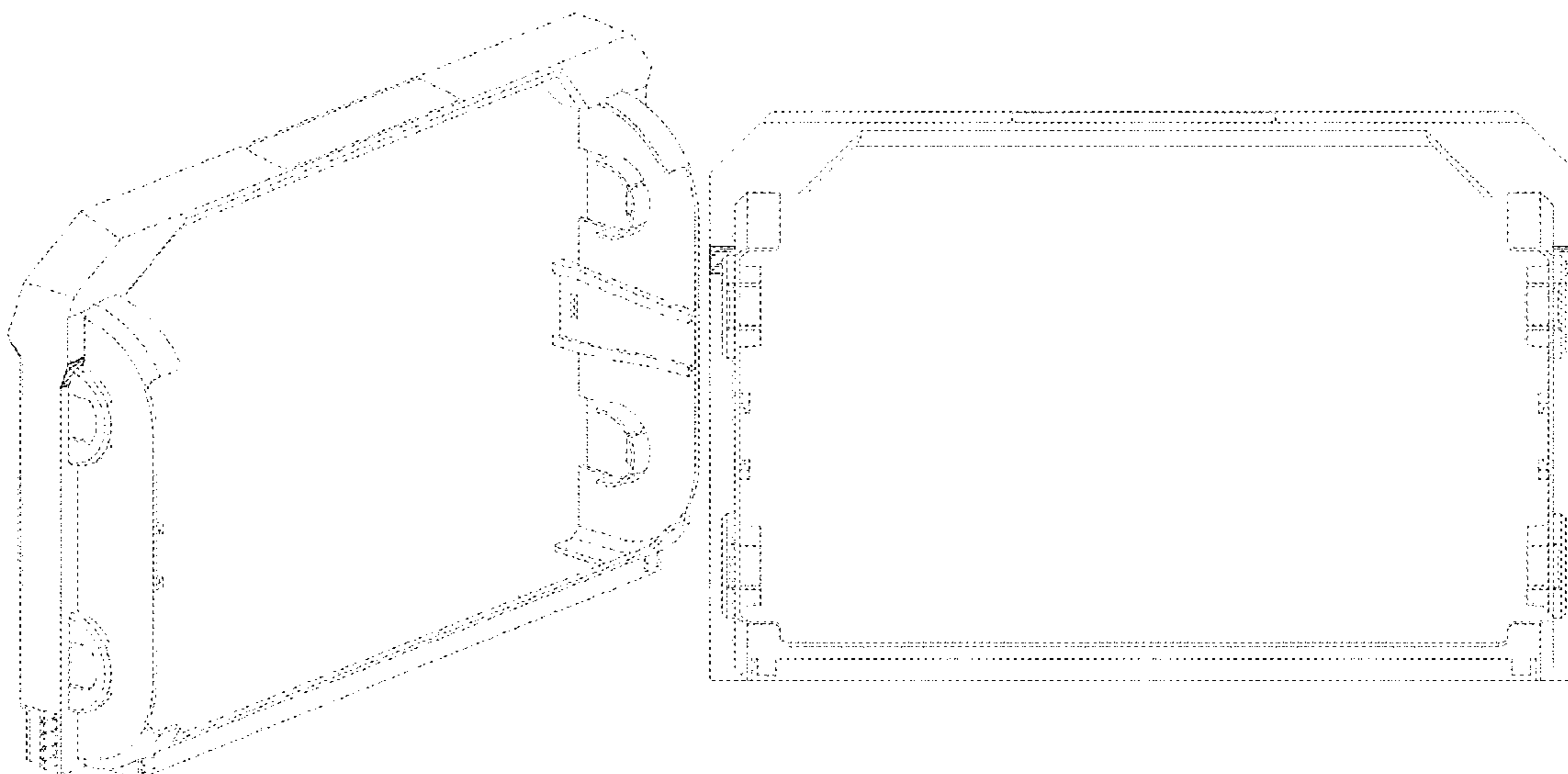
FIG. 6 is a top view of the laminating cartridge of FIG. 1;

and,

FIG. 7 is a bottom view of the laminating cartridge of FIG. 1.

The broken lines in the drawings depict portions of the laminating cartridge which form no part of the claimed design.

**1 Claim, 5 Drawing Sheets**



(56)

References Cited

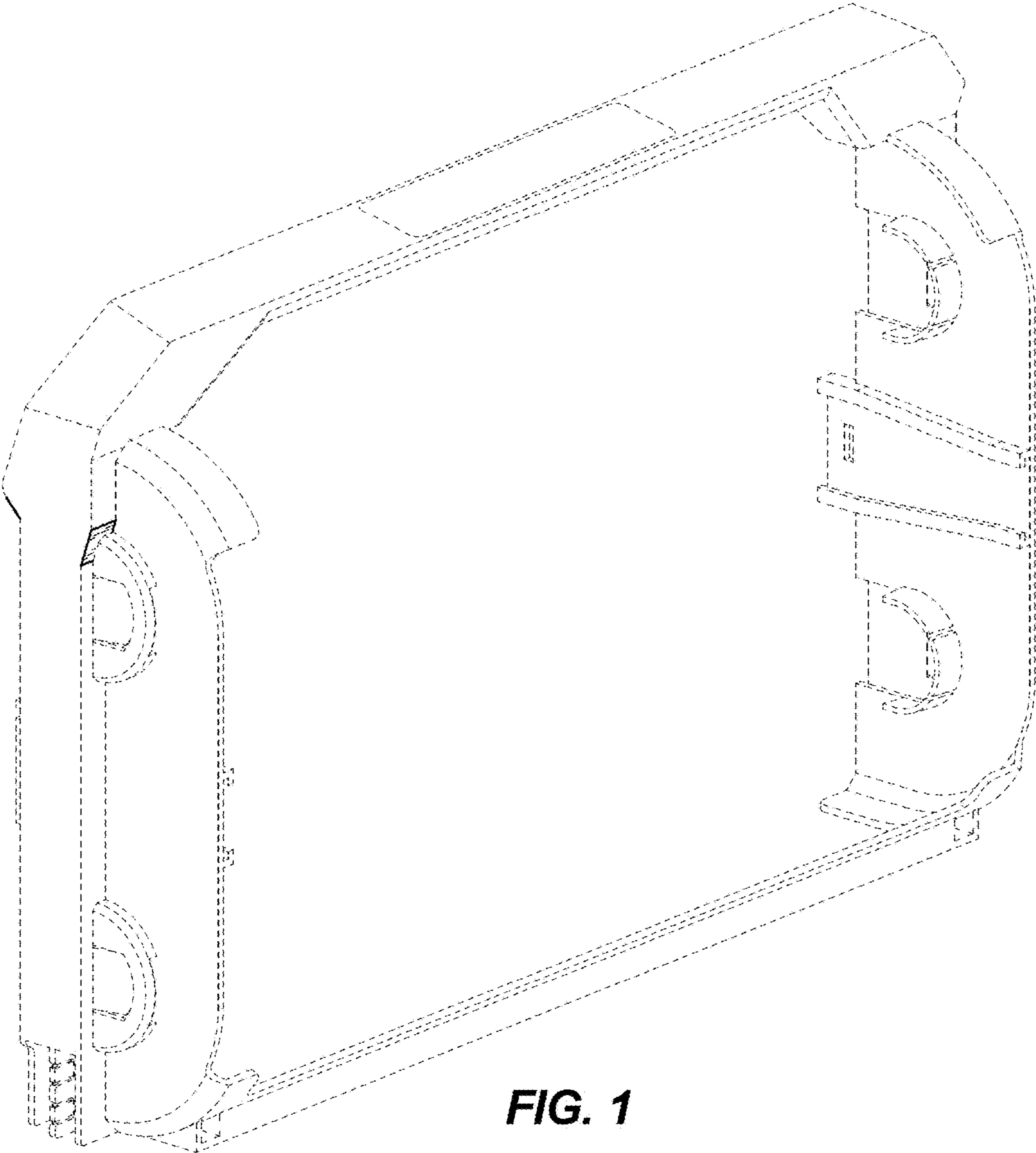
OTHER PUBLICATIONS

U.S. PATENT DOCUMENTS

6,843,297 B2 1/2005 McKay et al.  
 6,991,130 B2 1/2006 Presutti et al.  
 D519,555 S 4/2006 Sasaki et al.  
 D529,954 S 10/2006 Matsumoto  
 D534,169 S 12/2006 Nakamura et al.  
 D537,110 S 2/2007 Nakata et al.  
 D537,875 S 3/2007 Yamada  
 D538,338 S 3/2007 Matsumoto  
 D541,851 S 5/2007 Hattori et al.  
 D541,852 S 5/2007 Hattori et al.  
 D542,341 S 5/2007 Hattori et al.  
 D542,342 S 5/2007 Hattori et al.  
 D542,343 S 5/2007 Hattori et al.  
 D569,421 S 5/2008 Matsumoto  
 D569,422 S 5/2008 Matsumoto  
 D571,397 S 6/2008 Matsumoto  
 D580,971 S 11/2008 Yuen  
 D585,090 S 1/2009 Ishizawa  
 D585,091 S 1/2009 Matsumoto  
 D585,488 S 1/2009 Nozawa  
 D587,307 S 2/2009 Iwamuro  
 D595,767 S 7/2009 Hashimoto  
 D595,768 S 7/2009 Hashimoto  
 D597,129 S 7/2009 Tatsumi et al.  
 D598,050 S 9/2009 Nozawa  
 D599,399 S 9/2009 Hattori et al.  
 D619,644 S 7/2010 Houman et al.  
 7,766,063 B2 8/2010 Lauder et al.  
 D631,088 S 1/2011 Chadani et al.  
 D637,225 S 5/2011 Kishi et al.  
 D656,541 S 3/2012 Ko  
 8,967,892 B2 3/2015 Ishii et al.  
 D729,312 S 5/2015 Harvey et al.  
 D746,903 S 1/2016 Kitagawa et al.  
 D746,906 S 1/2016 Kitagawa et al.  
 9,566,771 B2 2/2017 Meier et al.  
 D798,949 S 10/2017 Toba et al.  
 D812,680 S 3/2018 Takiguchi et al.  
 D819,123 S 5/2018 Kitagawa et al.  
 D833,519 S 11/2018 Yang et al.  
 D833,520 S 11/2018 Yang et al.  
 D844,630 S 4/2019 Sawai et al.  
 D851,275 S 6/2019 Spuhler et al.  
 D851,353 S 6/2019 Miller  
 D872,148 S 1/2020 Drachenberg  
 2010/0307690 A1\* 12/2010 Chou ..... B32B 41/02  
 2013/0098558 A1 4/2013 Liu et al. 156/555

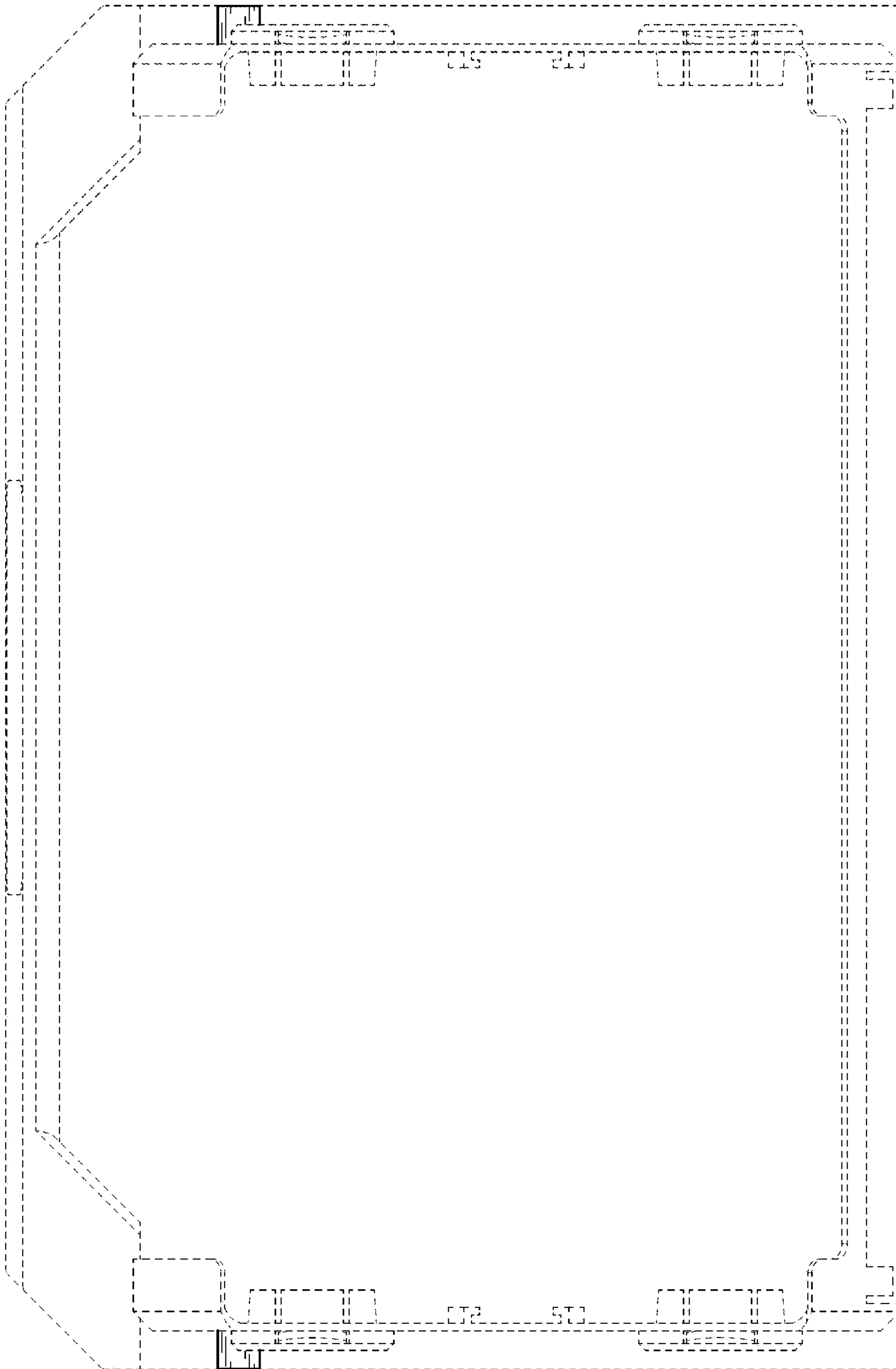
Xyron® “2.5in Create-A-Sticker™ Permanent Refill cartridge,” <[https://www.xyron.com/en-us/products/create-a-sticker/2-5--create-a-sticker/2-5in-cas-perm-adhesive\\_at255-20cftp/](https://www.xyron.com/en-us/products/create-a-sticker/2-5--create-a-sticker/2-5in-cas-perm-adhesive_at255-20cftp/)> webpage available at least as early as Sep. 12, 2015.  
 Xyron® “5in Create-A-Sticker™ Permanent Refill cartridge,” <[https://www.xyron.com/en-us/products/create-a-sticker/5--create-a-sticker-max/5in-cas-perm-adhesive\\_at1505-18/](https://www.xyron.com/en-us/products/create-a-sticker/5--create-a-sticker-max/5in-cas-perm-adhesive_at1505-18/)> webpage available at least as early as Sep. 7, 2015.  
 Xyron® “1.5in Sticker Maker Permanent Refill cartridge,” <[https://www.xyron.com/en-us/products/sticker-maker/sticker-makers---refillable/1-5--sticker-maker-permanent-refill\\_at155-20/](https://www.xyron.com/en-us/products/sticker-maker/sticker-makers---refillable/1-5--sticker-maker-permanent-refill_at155-20/)> webpage available at least as early as Sep. 6, 2015.  
 Xyron® “5in Creative Station™ Permanent Refill cartridge,” <[https://www.xyron.com/en-us/products/creative-station/5--creative-station/5in-cs-perm--adhesive-refill\\_at1605-18/](https://www.xyron.com/en-us/products/creative-station/5--creative-station/5in-cs-perm--adhesive-refill_at1605-18/)> webpage available at least as early as Sep. 12, 2015.  
 Xyron® “3in Creative Station™ Lite Permanent Refill cartridge,” <[https://www.xyron.com/en-us/products/creative-station/5--creative-station/xyron-creative-station-lite-3in-permanent-refill-cartridge\\_624741/](https://www.xyron.com/en-us/products/creative-station/5--creative-station/xyron-creative-station-lite-3in-permanent-refill-cartridge_624741/)> webpage available at east as early as Sep. 12, 2015.  
 Xyron® “9in Creative Station™ Permanent Refill cartridge,” <[https://www.xyron.com/en-us/products/creative-station/9--creative-station/9in-cs-perm-adhesive-refill\\_at905-40/](https://www.xyron.com/en-us/products/creative-station/9--creative-station/9in-cs-perm-adhesive-refill_at905-40/)> webpage available at least as early as Sep. 12, 2015.  
 Xyron® “EZ Laminator™ Two-Sided Laminate Refill,” <[https://www.xyron.com/en-us/products/xyron-professional-laminators/ezlaminator/ezlaminator-two-sided-lam-refill\\_145612/](https://www.xyron.com/en-us/products/xyron-professional-laminators/ezlaminator/ezlaminator-two-sided-lam-refill_145612/)> webpage available at least as early as Sep. 12, 2015.  
 Xyron® “XM1255 Permanent Standard Adhesive Refill ,” <[https://www.xyron.com/en-us/products/xyron-professional-laminators/xm1255/xm1255-permanent-standard-adhesive-refill\\_at1255-100/](https://www.xyron.com/en-us/products/xyron-professional-laminators/xm1255/xm1255-permanent-standard-adhesive-refill_at1255-100/)> webpage available at least as early as Sep. 12, 2015.  
 Xyron® “850 Permanent Refill,” <[https://www.xyron.com/en-us/products/other-xyron-products/850-refills/850-permanent-refill\\_at205-50/](https://www.xyron.com/en-us/products/other-xyron-products/850-refills/850-permanent-refill_at205-50/)> webpage available at least as early as Sep. 12, 2015.  
 Xyron® “1200 Permanent Refill ,” <[https://www.xyron.com/en-us/products/other-xyron-products/1200-refills/1200-permanent-refill\\_at%201105-50/](https://www.xyron.com/en-us/products/other-xyron-products/1200-refills/1200-permanent-refill_at%201105-50/)> webpage available at least as early as Sep. 12, 2015.  
 Xyron® “Stickz™ Permanent Adhesive Refill,” <[https://www.xyron.com/en-us/products/other-xyron-products/cretopia-refills/stickz--by-xyron-permanent-adhesive\\_3502-05-40/](https://www.xyron.com/en-us/products/other-xyron-products/cretopia-refills/stickz--by-xyron-permanent-adhesive_3502-05-40/)> webpage available at least as early as Sep. 12, 2015.

\* cited by examiner

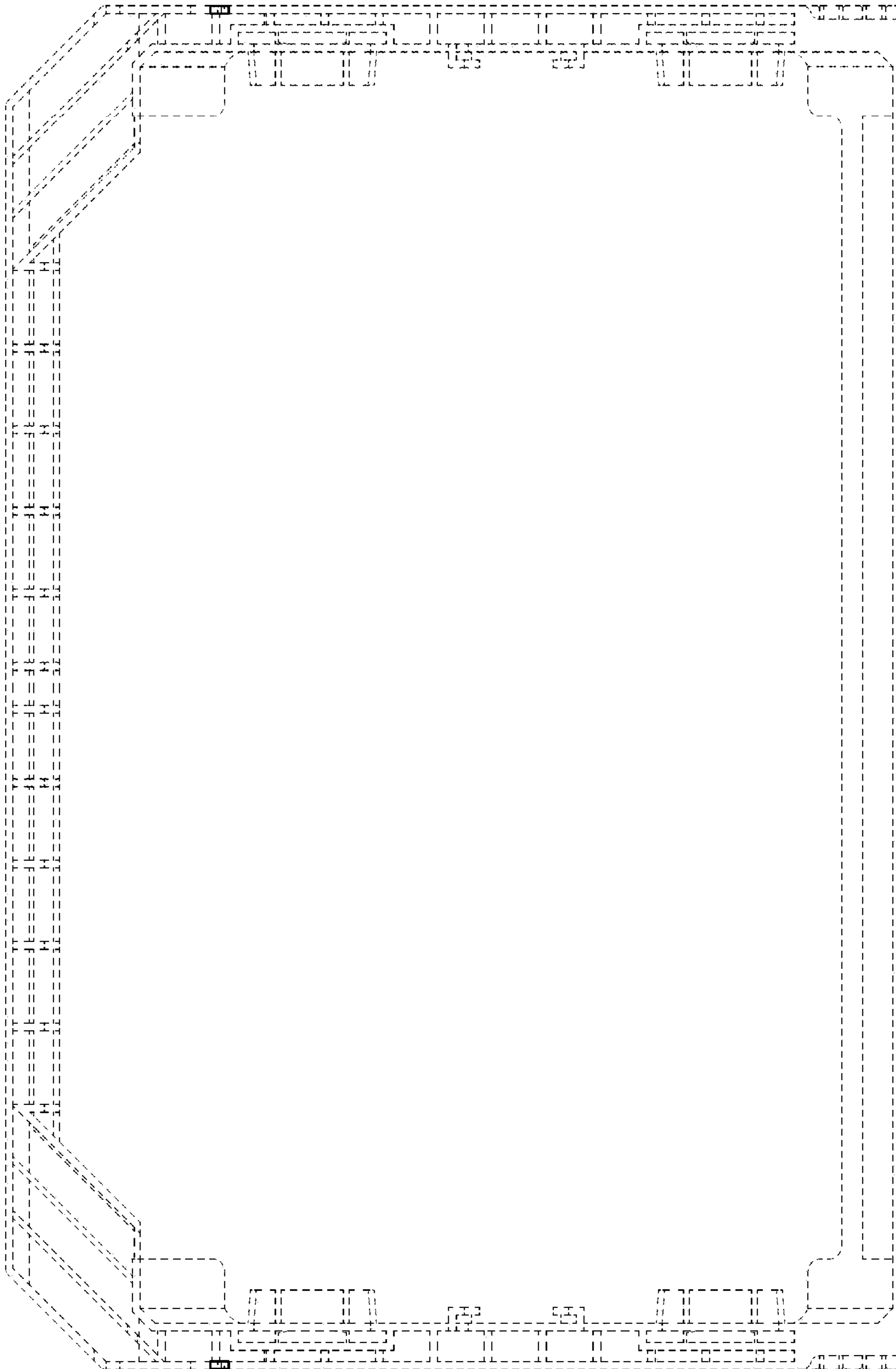


**FIG. 1**

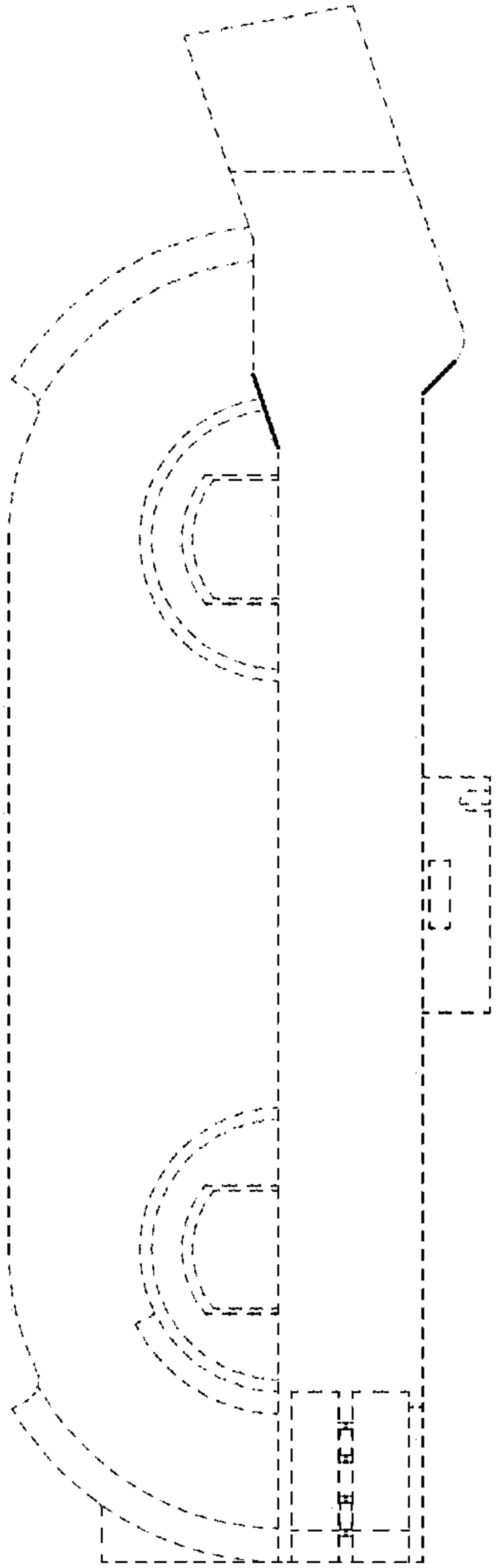




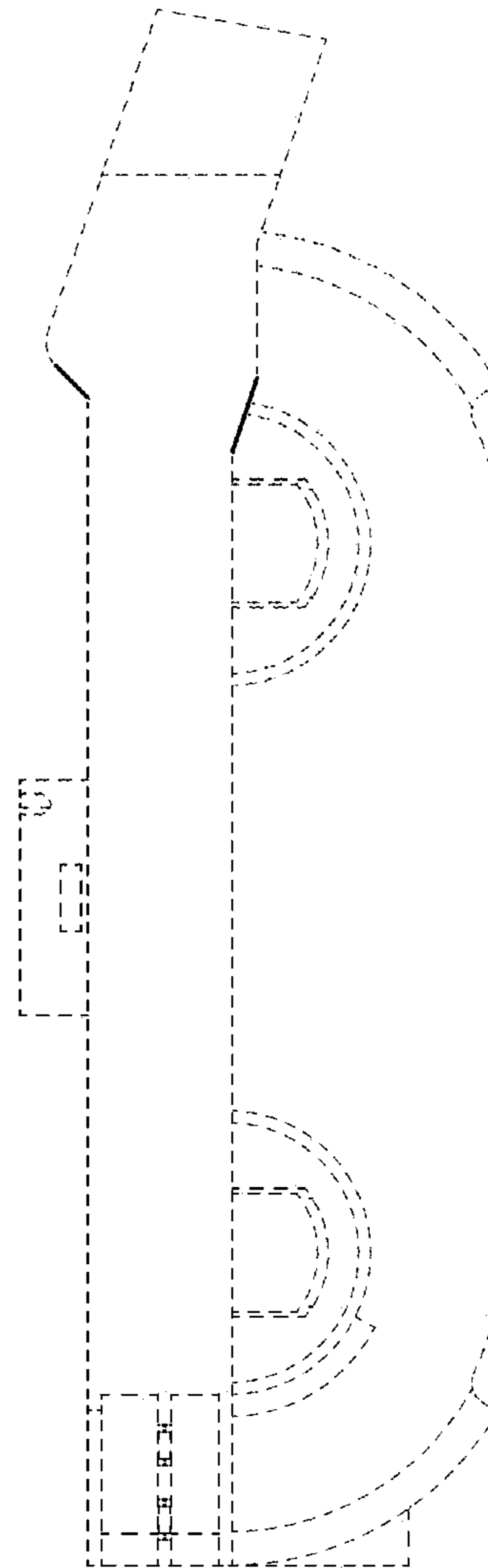
**FIG. 2**



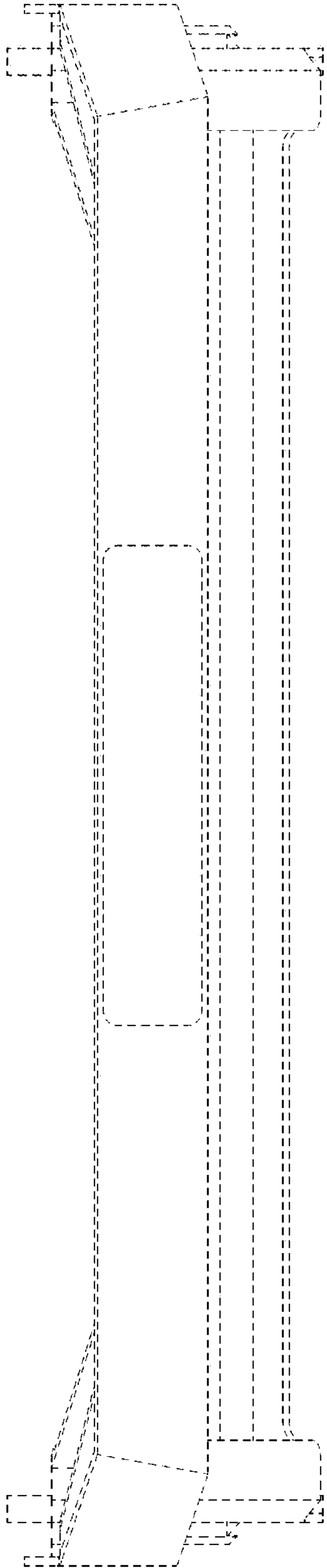
**FIG. 3**



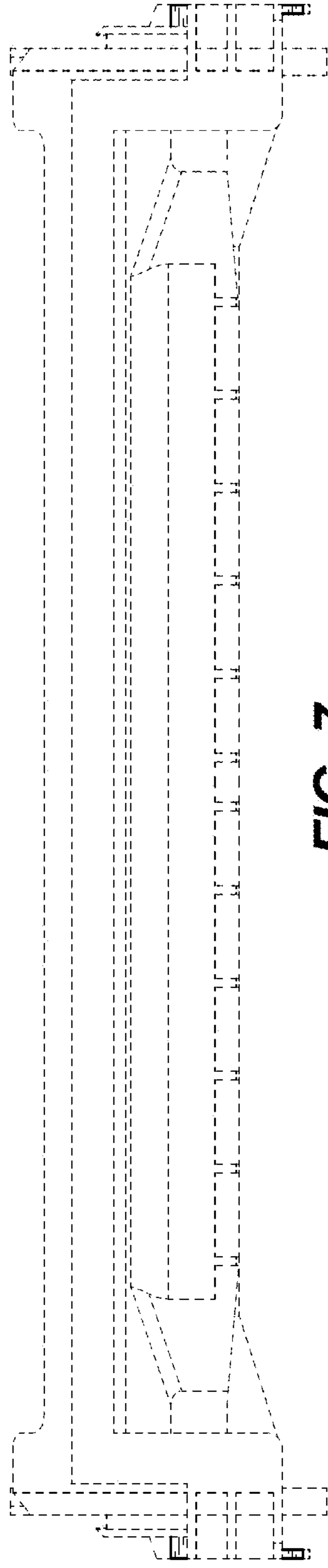
**FIG. 4**



**FIG. 5**



**FIG. 6**



**FIG. 7**