



US00D906961S

(12) **United States Design Patent** (10) **Patent No.:** **US D906,961 S**
Kato et al. (45) **Date of Patent:** **** Jan. 5, 2021**

(54) **SERVO AMPLIFIER**
(71) Applicant: **Mitsubishi Electric Corporation,**
Tokyo (JP)
(72) Inventors: **Shinichi Kato,** Tokyo (JP); **Masaaki**
Kadoyanagi, Tokyo (JP); **Kentaro**
Tsukamoto, Tokyo (JP); **Shotaro**
Hirako, Tokyo (JP)

D561,095 S * 2/2008 Sakai D13/110
D654,024 S * 2/2012 Choi D13/110
D684,533 S * 6/2013 Nakahira D13/110
D684,534 S * 6/2013 Nakahira D13/110
D713,336 S * 9/2014 Perin D13/110
D745,847 S * 12/2015 Ho D13/110
D755,123 S * 5/2016 Ho D13/110
D771,565 S * 11/2016 Saarivirta D13/110

(Continued)

(73) Assignee: **Mitsubishi Electric Corporation,**
Tokyo (JP)

(**) Term: **15 Years**

(21) Appl. No.: **29/695,141**

(22) Filed: **Jun. 17, 2019**

(30) **Foreign Application Priority Data**

Jan. 31, 2019 (JP) 2019-001871
Jan. 31, 2019 (JP) 2019-001872
Jan. 31, 2019 (JP) 2019-001873

(51) **LOC (13) Cl.** **13-02**

(52) **U.S. Cl.**
USPC **D13/110**

(58) **Field of Classification Search**
USPC D13/107, 108, 109, 110, 118, 119, 184;
D14/251, 253, 432, 434
CPC Y02E 60/12; Y02T 90/14; Y02T 90/122;
Y02T 90/128; Y02T 90/163; Y02T
10/7005; Y02T 10/705; Y02T 10/7088;
H02J 7/025; H02J 7/0042; H02J 7/0044;
H02J 7/0054; H02J 7/1423; H02J
2001/006; H01F 38/14; H01R 13/6675;
H01M 2/1022; H01M 2/1055; H01M
10/46; H01M 10/425; B60L 11/182
See application file for complete search history.

(56) **References Cited**

U.S. PATENT DOCUMENTS

D501,648 S * 2/2005 Fiorentino G06F 1/188
D13/110
D510,319 S * 10/2005 Tuomola D13/110

OTHER PUBLICATIONS

An Office Action mailed by the Korean Intellectual Property Office dated Oct. 14, 2019, which corresponds to Korean Design Application No. 2019-0027574 and is related to Design U.S. Appl. No. 29/695,141.

Primary Examiner — Janice Hallmark

Assistant Examiner — Suzanne E Tisdell

(74) *Attorney, Agent, or Firm* — Studebaker & Brackett
PC

(57) **CLAIM**

The ornamental design for a servo amplifier, as shown and described.

DESCRIPTION

FIG. 1. is a front perspective view of the front, left, and top sides of a servo amplifier showing our new design;
FIG. 2. is a rear perspective view of the rear, right, and bottom sides thereof;
FIG. 3. is a front view thereof;
FIG. 4. is a rear view thereof;
FIG. 5. is a top plan view thereof;
FIG. 6. is a bottom plan view thereof;
FIG. 7. is a right side view thereof; and,
FIG. 8. is a left side view thereof.
The broken lines shown represent portions of the servo amplifier and form no part of the claimed design.

1 Claim, 8 Drawing Sheets

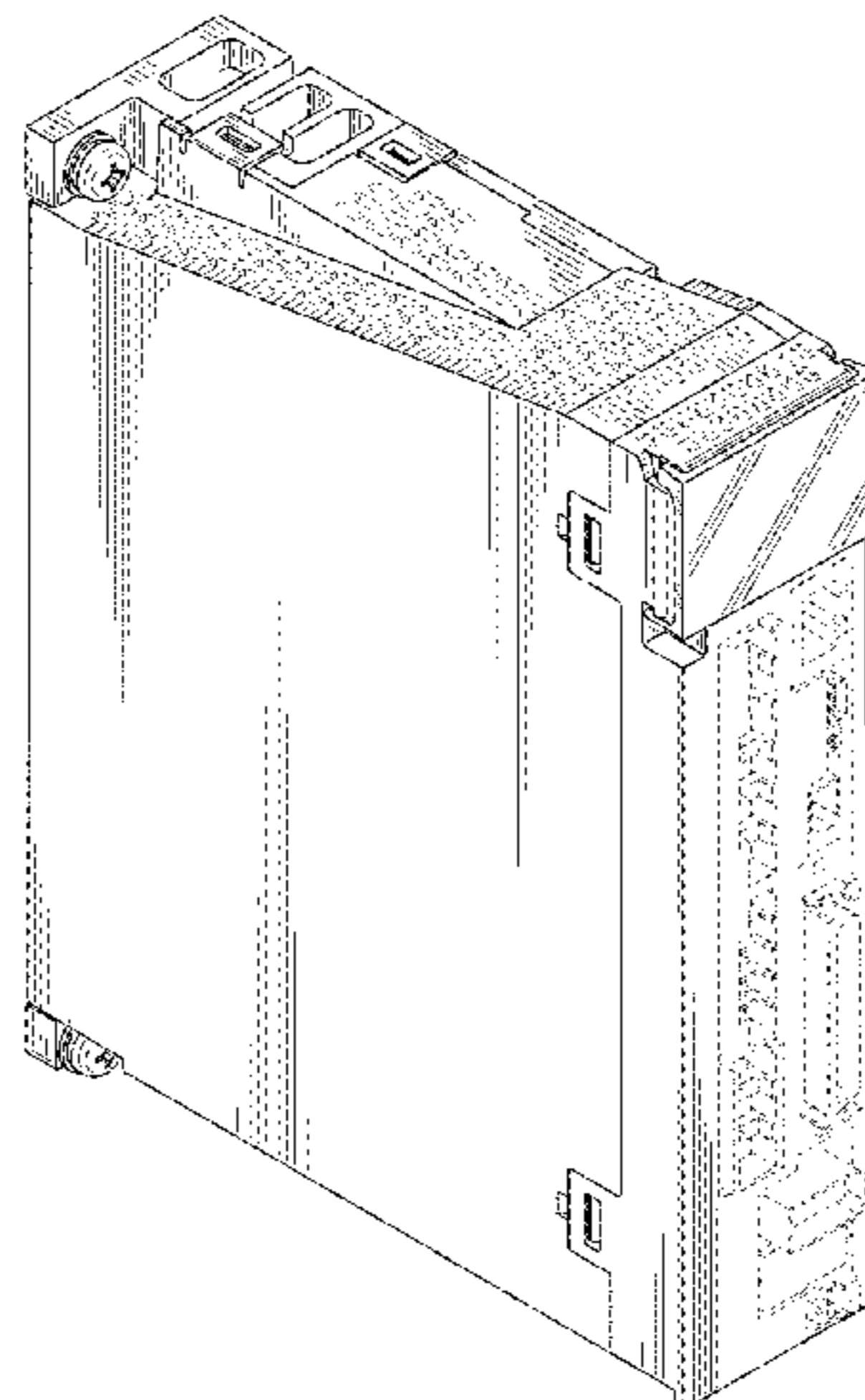

(56)

References Cited

U.S. PATENT DOCUMENTS

D771,566 S * 11/2016 Saarivirta D13/110
D772,161 S * 11/2016 Saarivirta D13/110
D772,162 S * 11/2016 Saarivirta D13/110
D796,431 S * 9/2017 Lau D13/107
D815,592 S * 4/2018 Lau D13/107
D828,294 S * 9/2018 Lau D13/107
10,074,844 B2 * 9/2018 Wada B60L 58/21
D840,335 S * 2/2019 Gleave D13/110
D862,386 S * 10/2019 Beer D13/110
D876,349 S * 2/2020 Nagano D13/110

* cited by examiner

FIG. 1

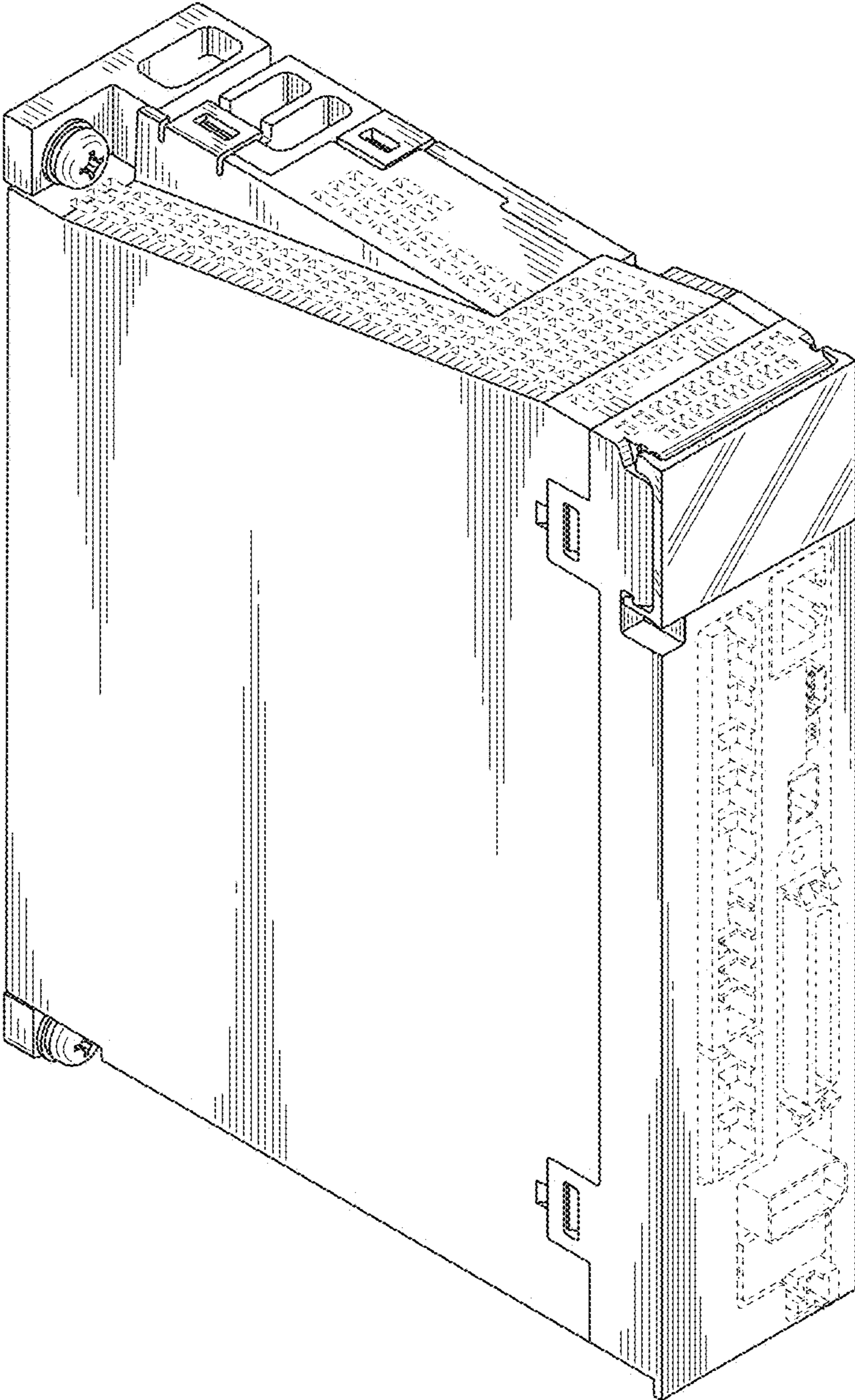

FIG. 2

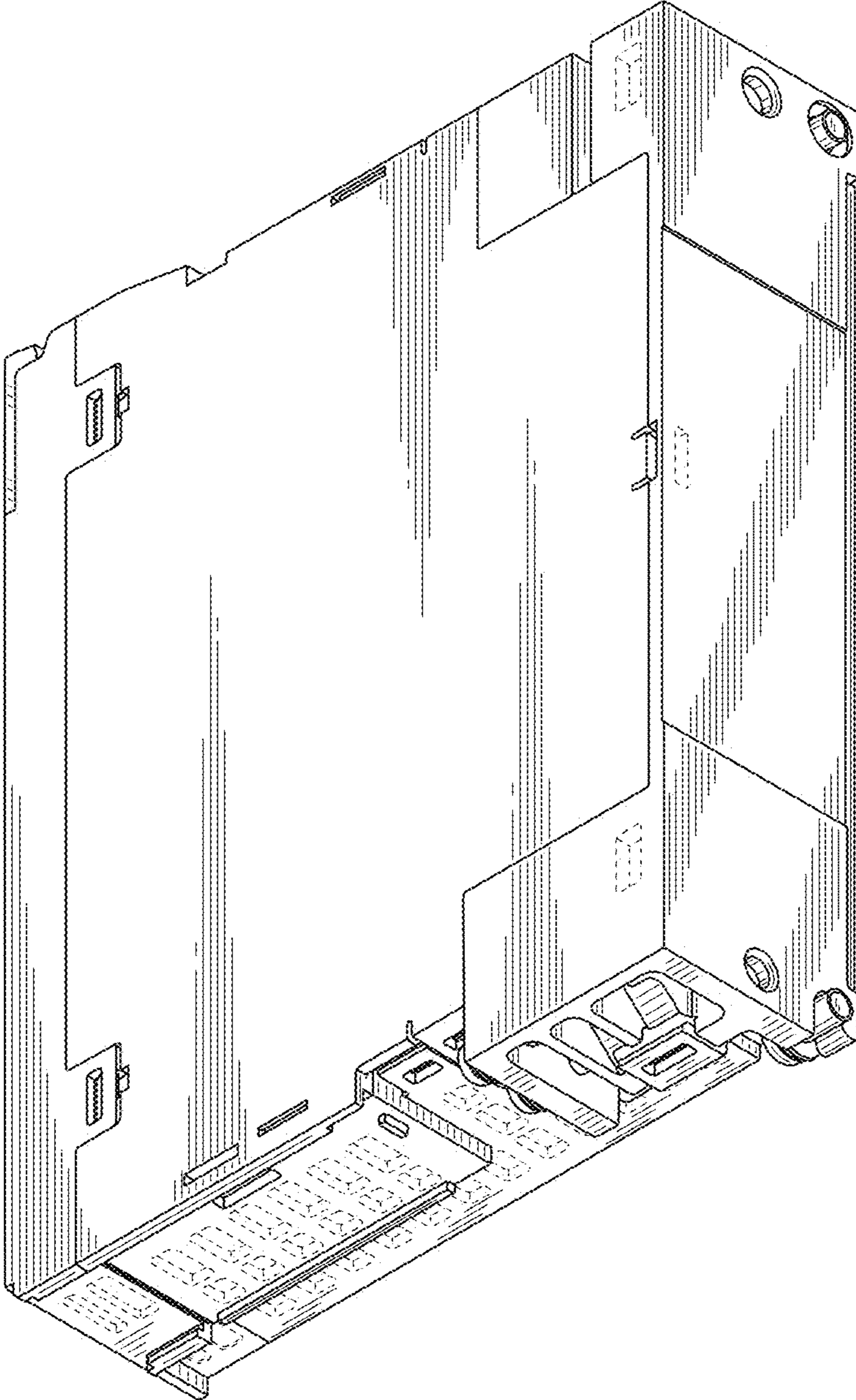

FIG. 3

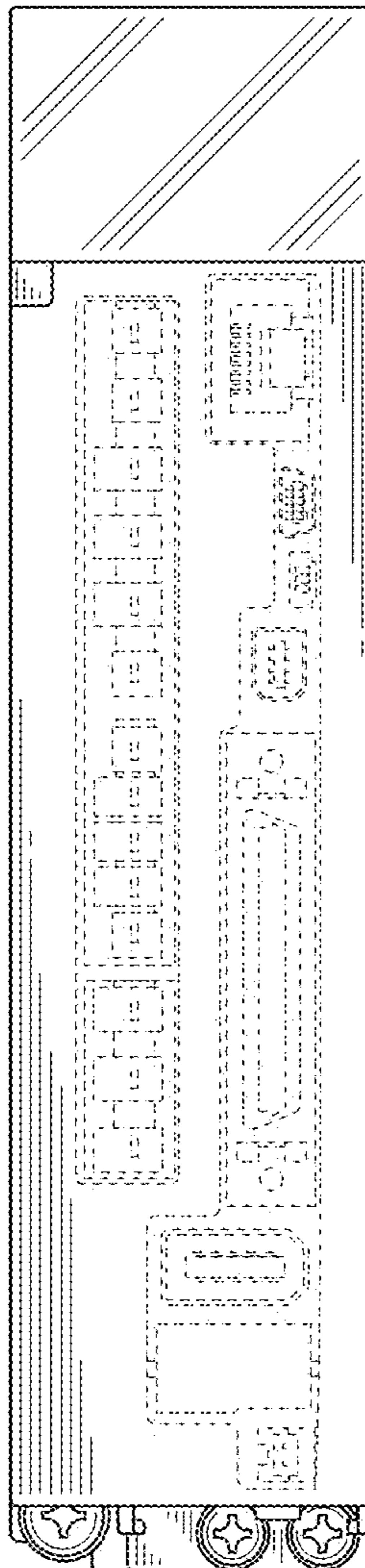

FIG. 4

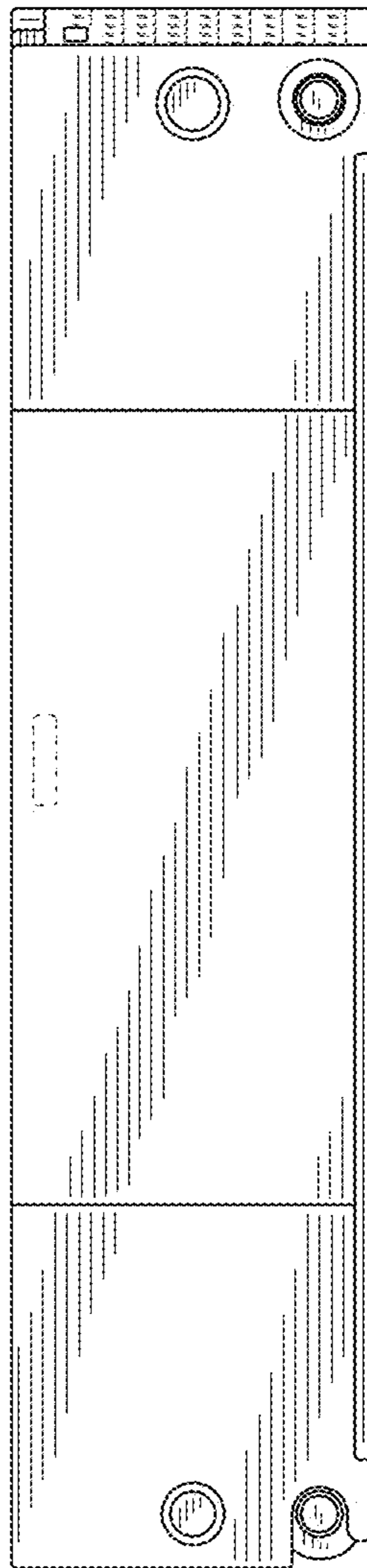

FIG. 5

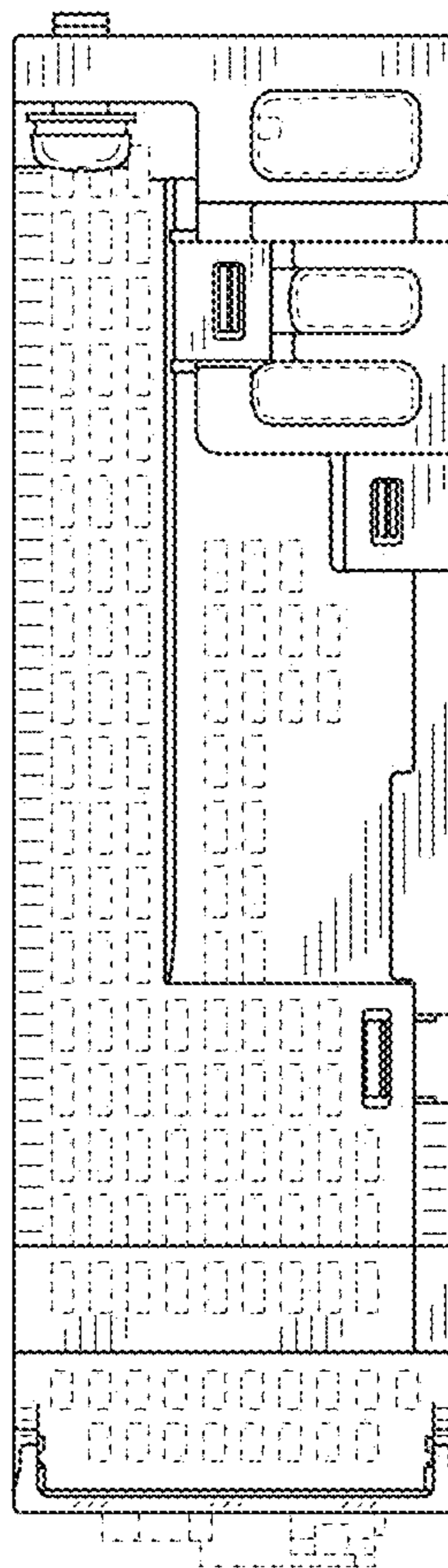

FIG. 6

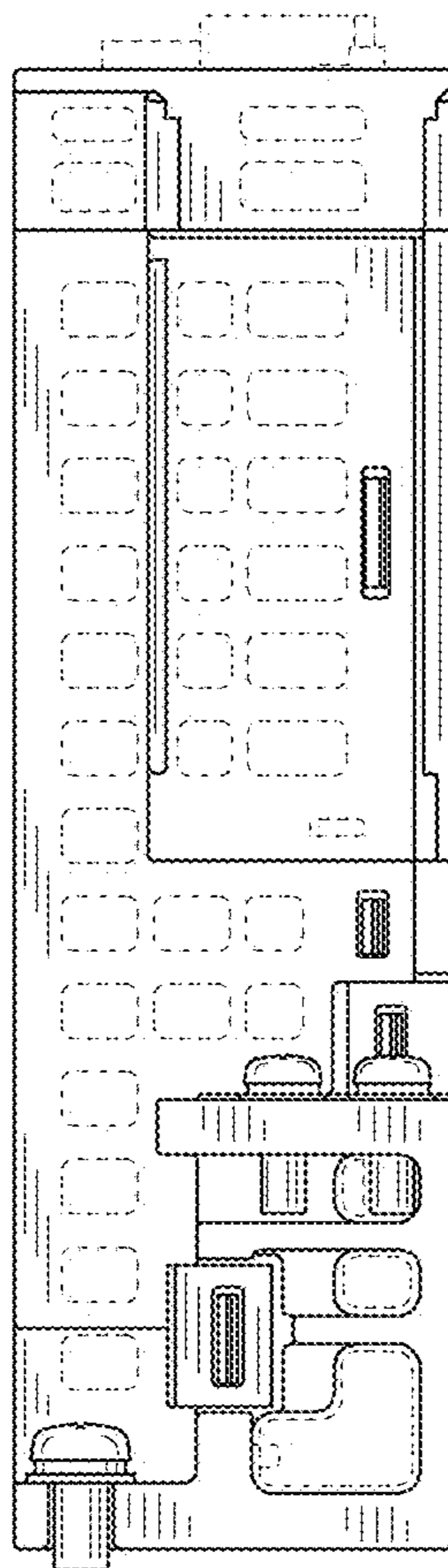

FIG. 7

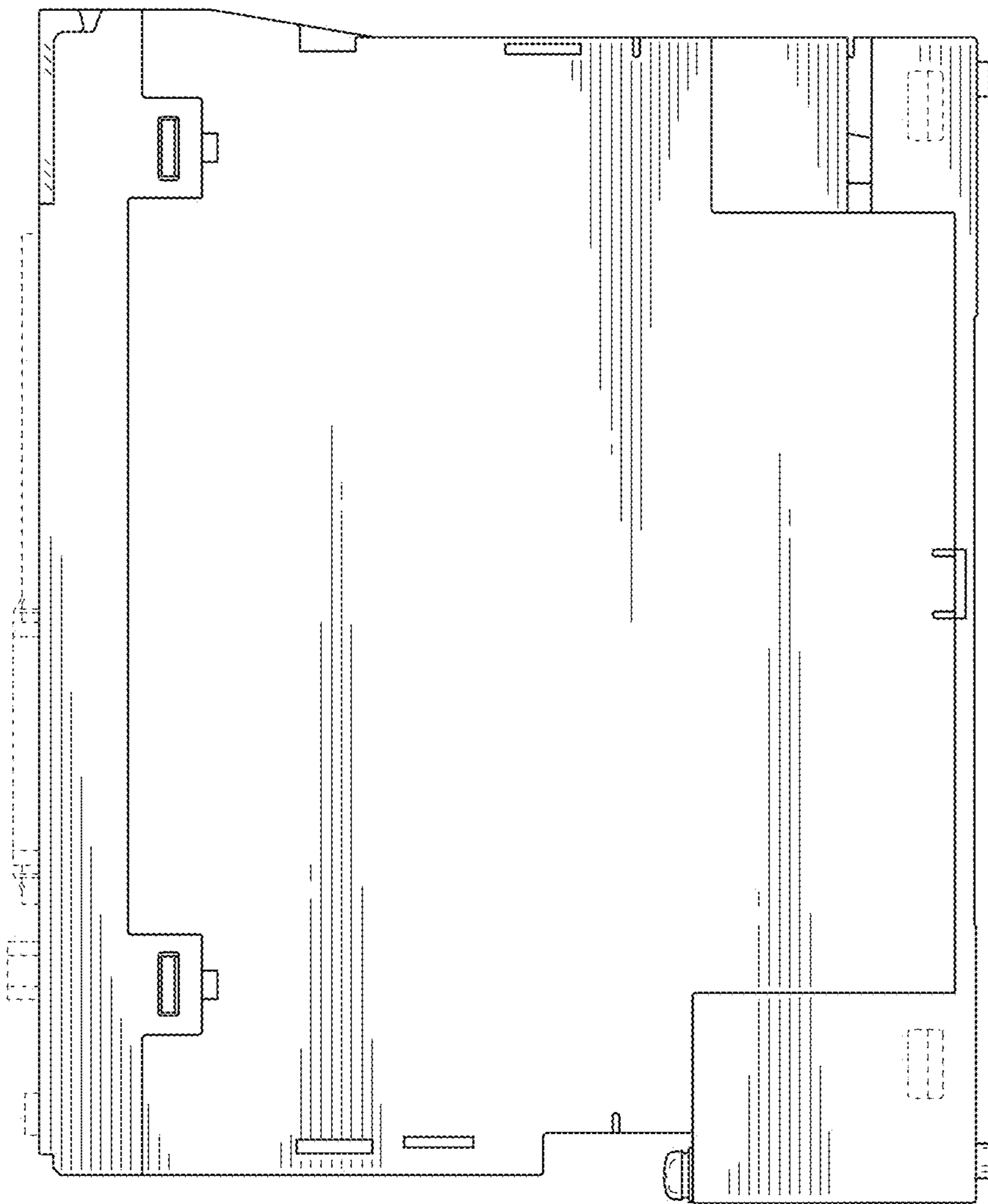

FIG. 8

