



US00D906945S

(12) **United States Design Patent**
Dooling

(10) **Patent No.:** **US D906,945 S**
(45) **Date of Patent:** **** Jan. 5, 2021**

(54) **MOTORCYCLE BAG**

(71) Applicant: **Daniel J. Dooling**, Fenton, MI (US)

(72) Inventor: **Daniel J. Dooling**, Fenton, MI (US)

(73) Assignee: **LOAD LUGGER, LLC**, Fenton, MI (US)

(**) Term: **15 Years**

(21) Appl. No.: **29/668,594**

(22) Filed: **Oct. 31, 2018**

(51) **LOC (13) Cl.** **12-16**

(52) **U.S. Cl.**
USPC **D12/409**

(58) **Field of Classification Search**
USPC D12/400-403, 409, 410, 415, 114
CPC B62J 19/00; B62J 23/00; E04H 6/005
See application file for complete search history.

(56) **References Cited**

U.S. PATENT DOCUMENTS

3,861,092	A *	1/1975	Dale	E04H 6/005
					52/66
4,792,040	A *	12/1988	Wagstaff	A41D 3/06
					150/167
D322,054	S *	12/1991	Reiter	D12/402
D334,837	S *	4/1993	Bradley	D12/402
D341,552	S *	11/1993	Schardt	D12/114
D371,106	S *	6/1996	Taylor	D12/402
5,533,616	A *	7/1996	Crowfoot	B65D 85/68
					206/335
D405,045	S *	2/1999	Sauve	D12/402
6,505,637	B1 *	1/2003	Voorhees	B62H 3/00
					135/87
6,718,697	B2 *	4/2004	Voorhees	B62H 3/00
					135/87

(Continued)

Primary Examiner — Michelle E. Wilson
Assistant Examiner — Clese Moore, Jr.

(74) *Attorney, Agent, or Firm* — North Star IP Law PLLC; Edmund P. Anderson

(57) **CLAIM**

The ornamental design for a motorcycle bag, as shown and described.

DESCRIPTION

FIG. 1 is a perspective view of the front, top and right sides of an embodiment of a motorcycle bag with two partially peripherally-extending, centrally-overlapping zippers, two outwardly-protruding, flexible, attachment access ports, and a selectively openable and closable motorcycle stand access panel (closed condition) showing our new design with the zippers and bag in a closed/zipped condition and the zippers covered by a storm flap;

FIG. 2 is a right side view thereof;

FIG. 3 is a left side view thereof;

FIG. 4 is a top view thereof;

FIG. 5 is a bottom view thereof;

FIG. 6 is a front view thereof;

FIG. 7 is a rear view thereof;

FIG. 8 is a front view thereof in an open/unzipped condition illustrating, in phantom, a motorcycle disposed therein having a pair of selectively attachable/detachable attachment points disposed on the motorcycle handlebars;

FIG. 9 is the front view of FIG. 6 thereof in the closed/zipped condition illustrating, in phantom, a motorcycle disposed therein that is detachably attached to a transportation deck using the attachment points by a pair of selectively adjustable tensioning straps;

FIG. 10 is an enlarged partial bottom view thereof illustrating the motorcycle stand access panel in a partially open condition; and,

FIG. 11 is an enlarged partial top view thereof with the two partially peripherally-extending, centrally overlapping zippers in a partially open/unzipped condition revealing an overlapping configuration of the zippers.

1 Claim, 12 Drawing Sheets

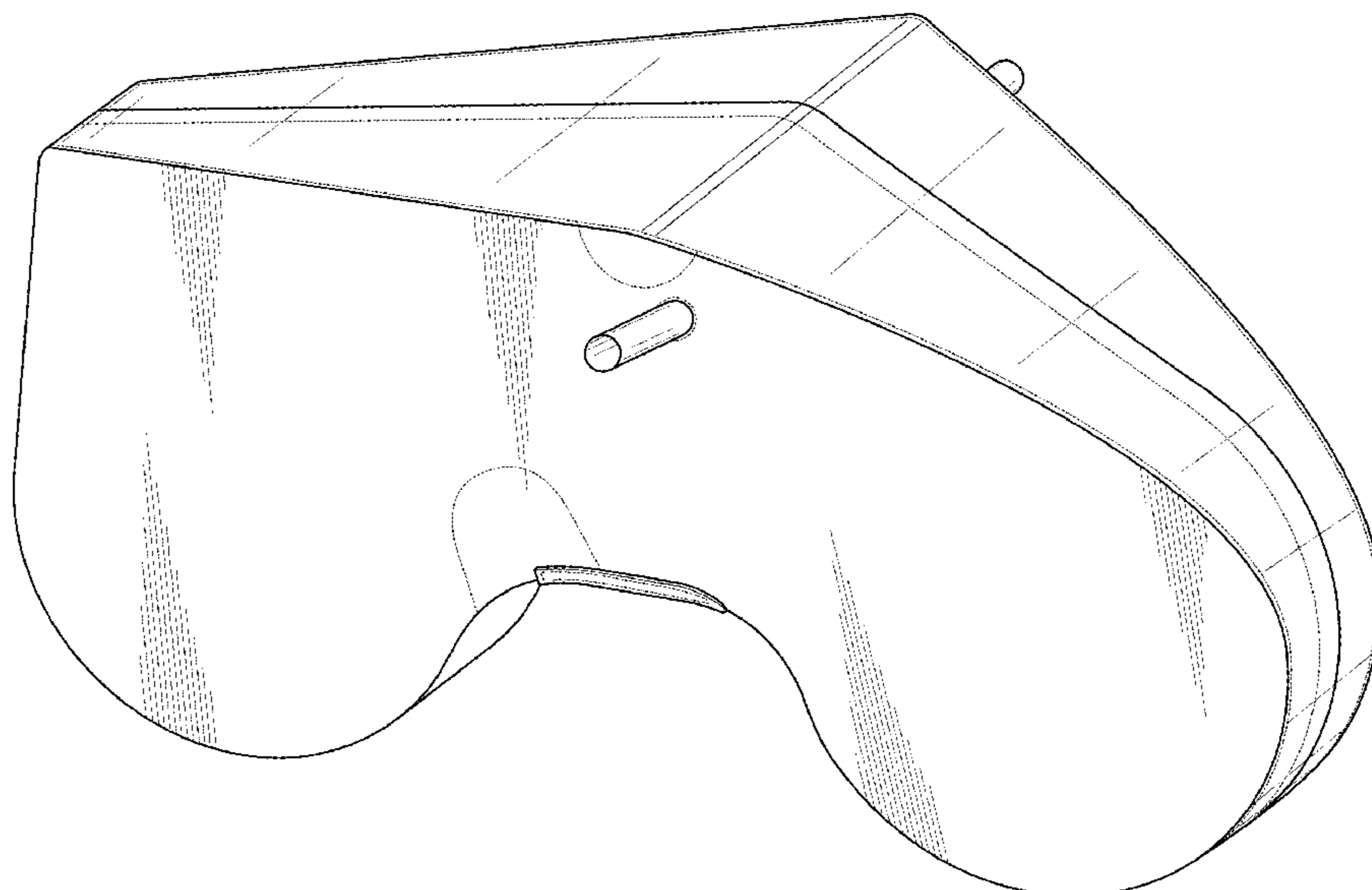

(56)

References Cited

U.S. PATENT DOCUMENTS

D492,243	S *	6/2004	Greene	D12/410
6,857,533	B1 *	2/2005	Jackson	B65D 85/68
				206/335
D520,442	S *	5/2006	Lucarelli	D12/409
D588,978	S *	3/2009	Powers	D12/402
D619,939	S *	7/2010	Olsen	D12/133
D626,060	S *	10/2010	Rians	D12/402
D691,549	S *	10/2013	Kara	D12/402
D723,451	S *	3/2015	Depew, Jr.	D12/402
D781,209	S *	3/2017	Houck	D12/402
D803,762	S *	11/2017	Greenblatt	D12/402
D833,956	S *	11/2018	Xiao	D12/402
2005/0102917	A1 *	5/2005	Kofler	E04H 6/005
				52/79.1
2007/0158975	A1 *	7/2007	Atchison	E04H 6/005
				296/182.1
2012/0037286	A1 *	2/2012	Wilkinson	B62J 19/00
				150/167
2016/0362065	A1	12/2016	Dooling et al.	
2019/0218809	A1 *	7/2019	Pearson	E04H 6/005
2020/0130765	A1 *	4/2020	Dooling	B62J 19/00

* cited by examiner

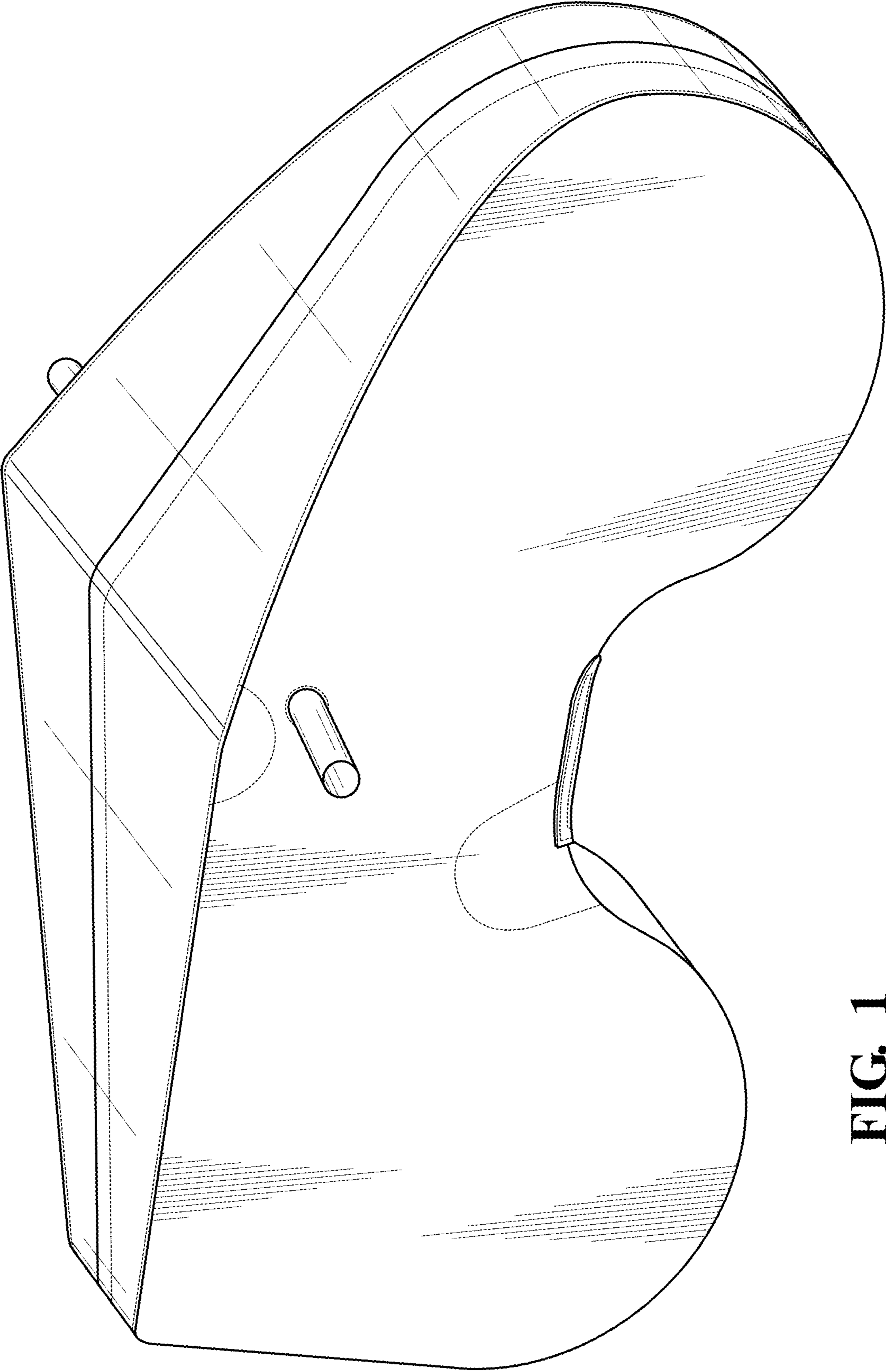

FIG. 1

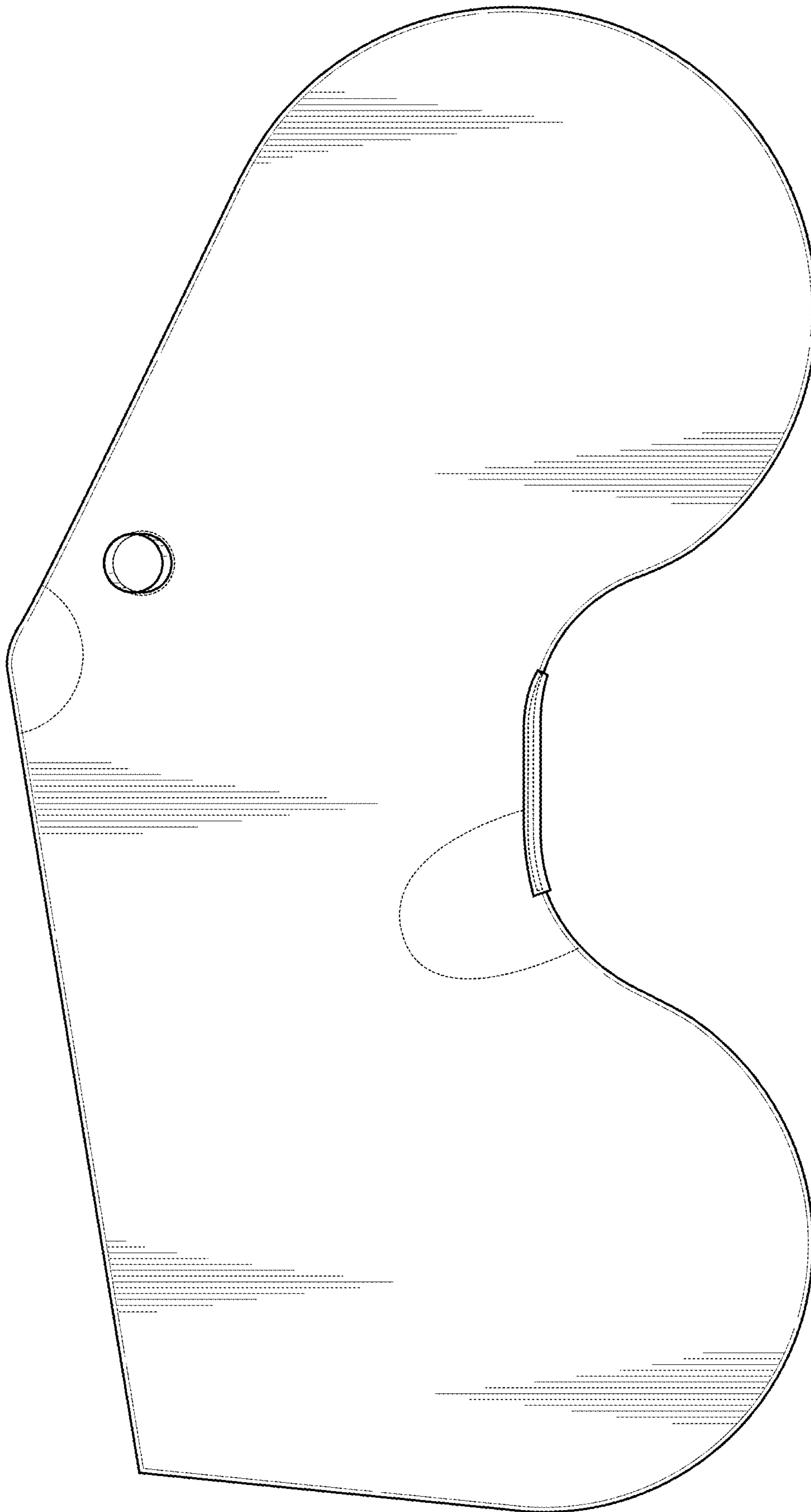

FIG. 2

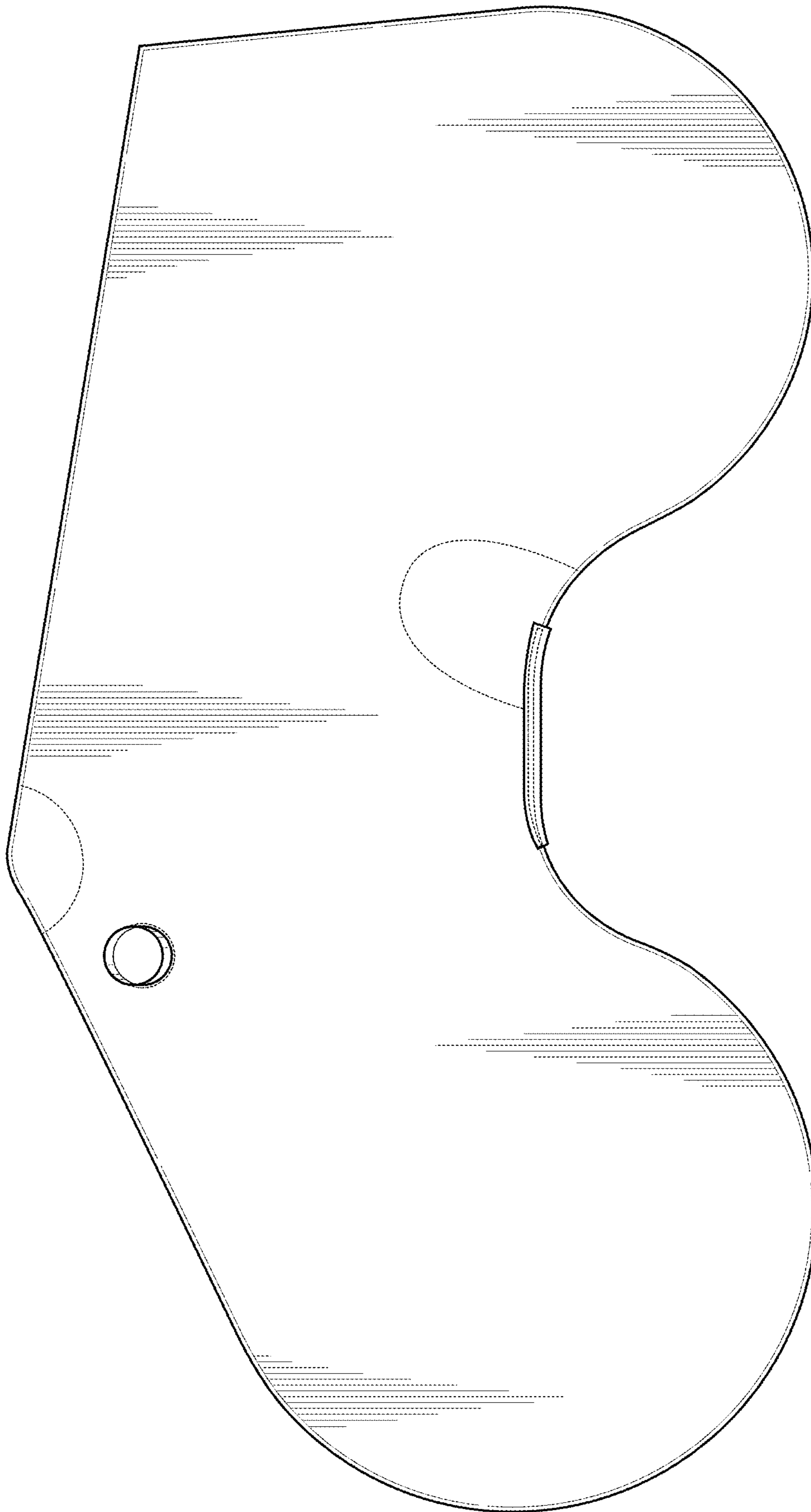

FIG. 3

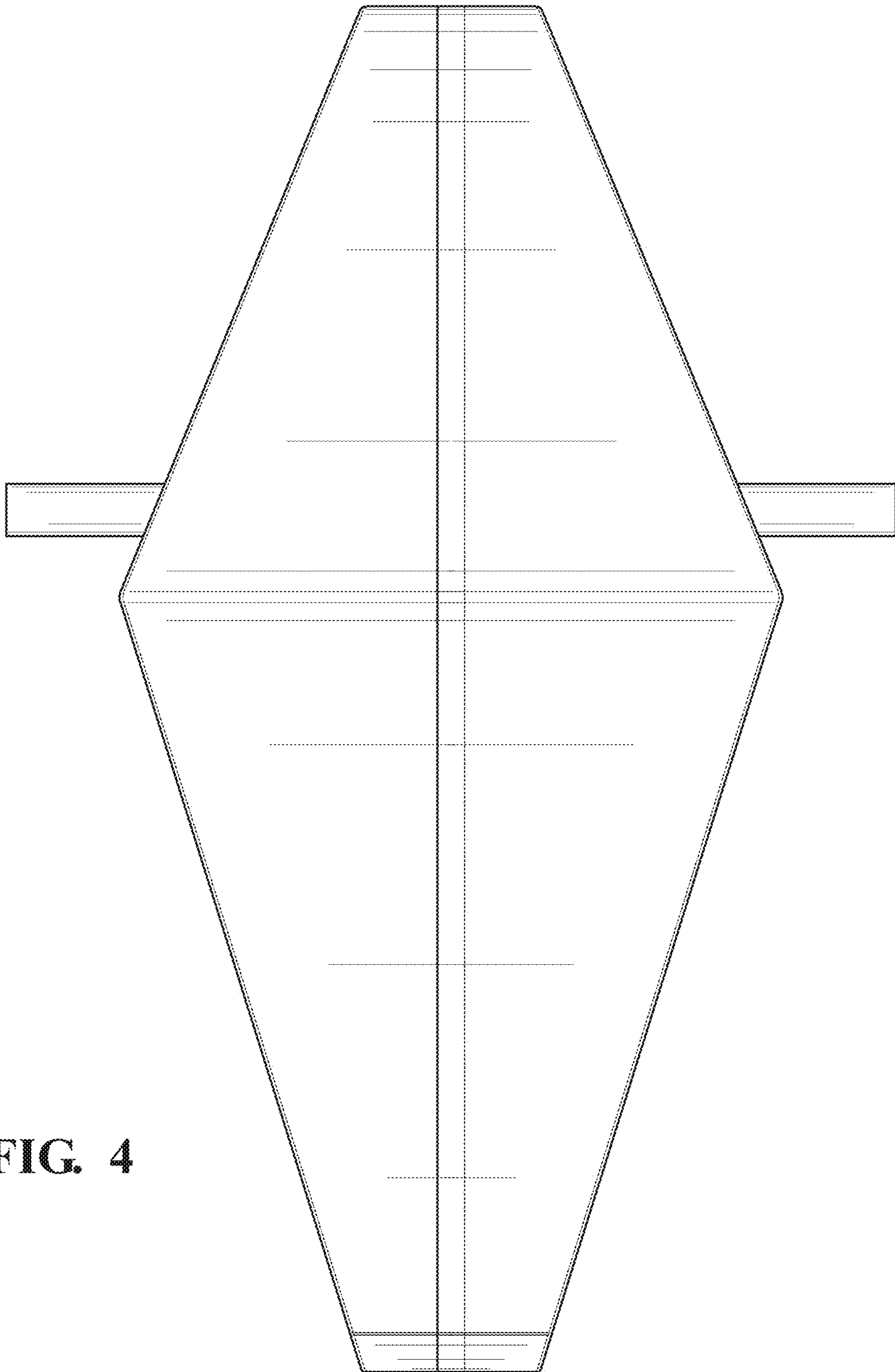

FIG. 4

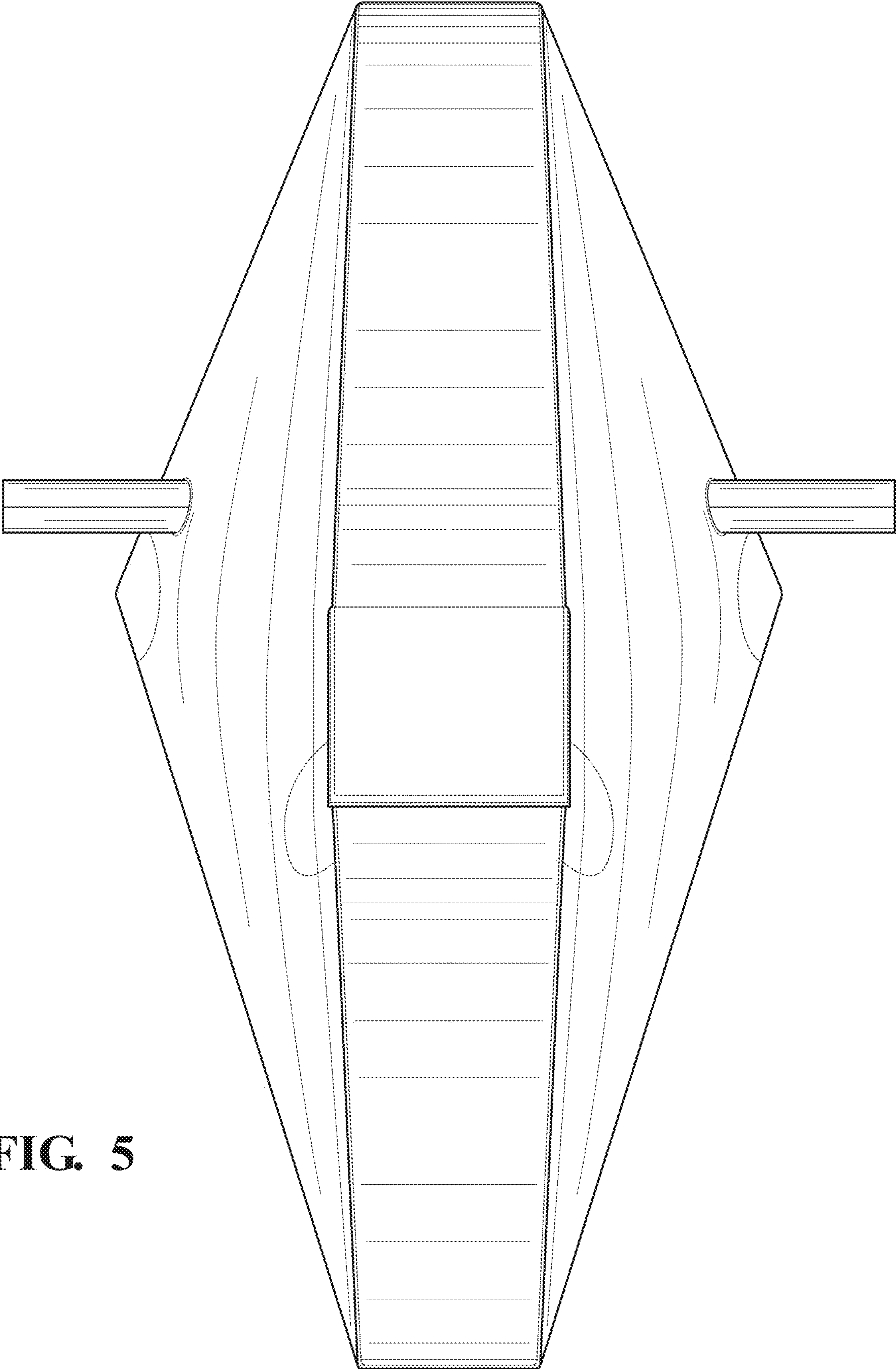

FIG. 5

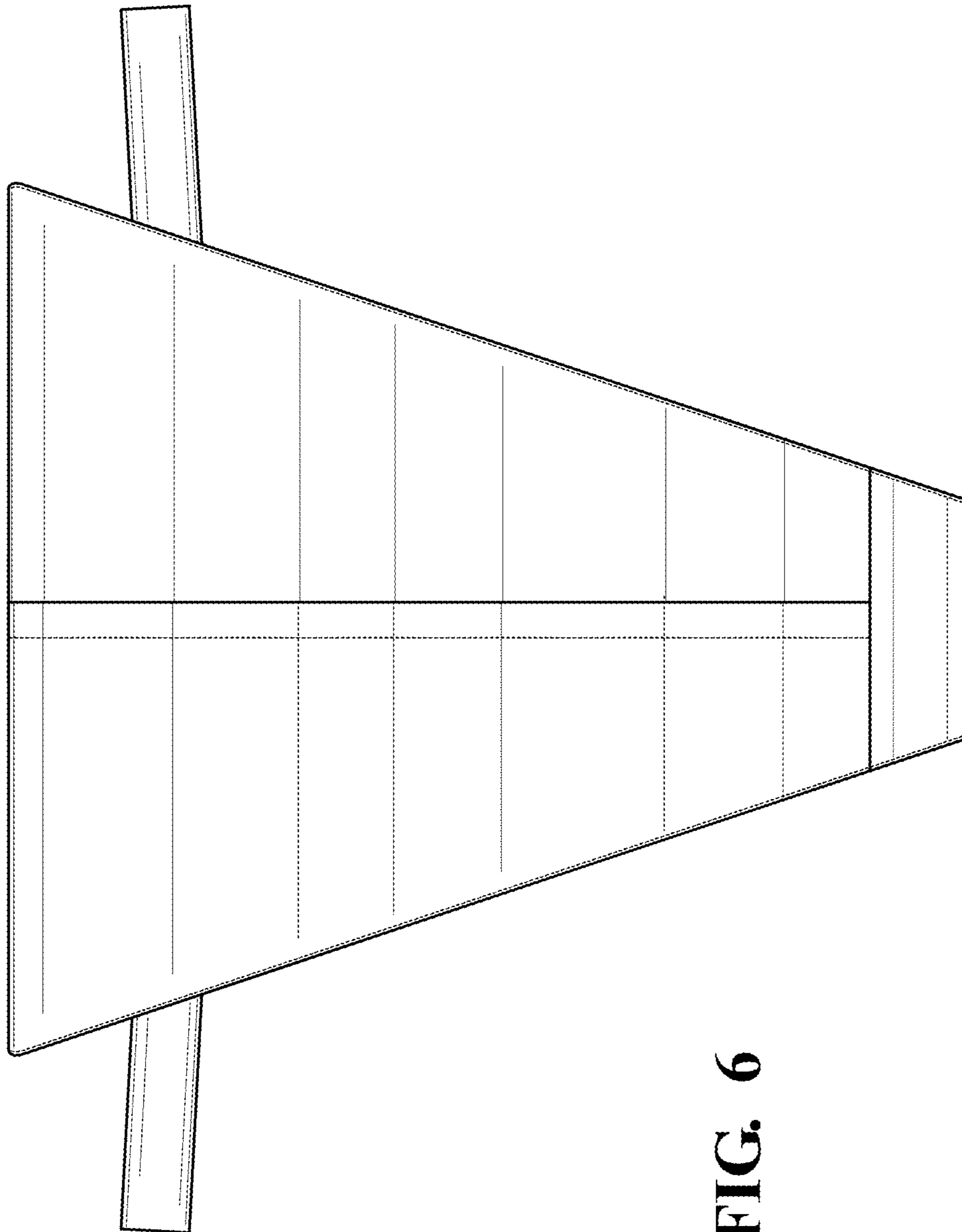

FIG. 6

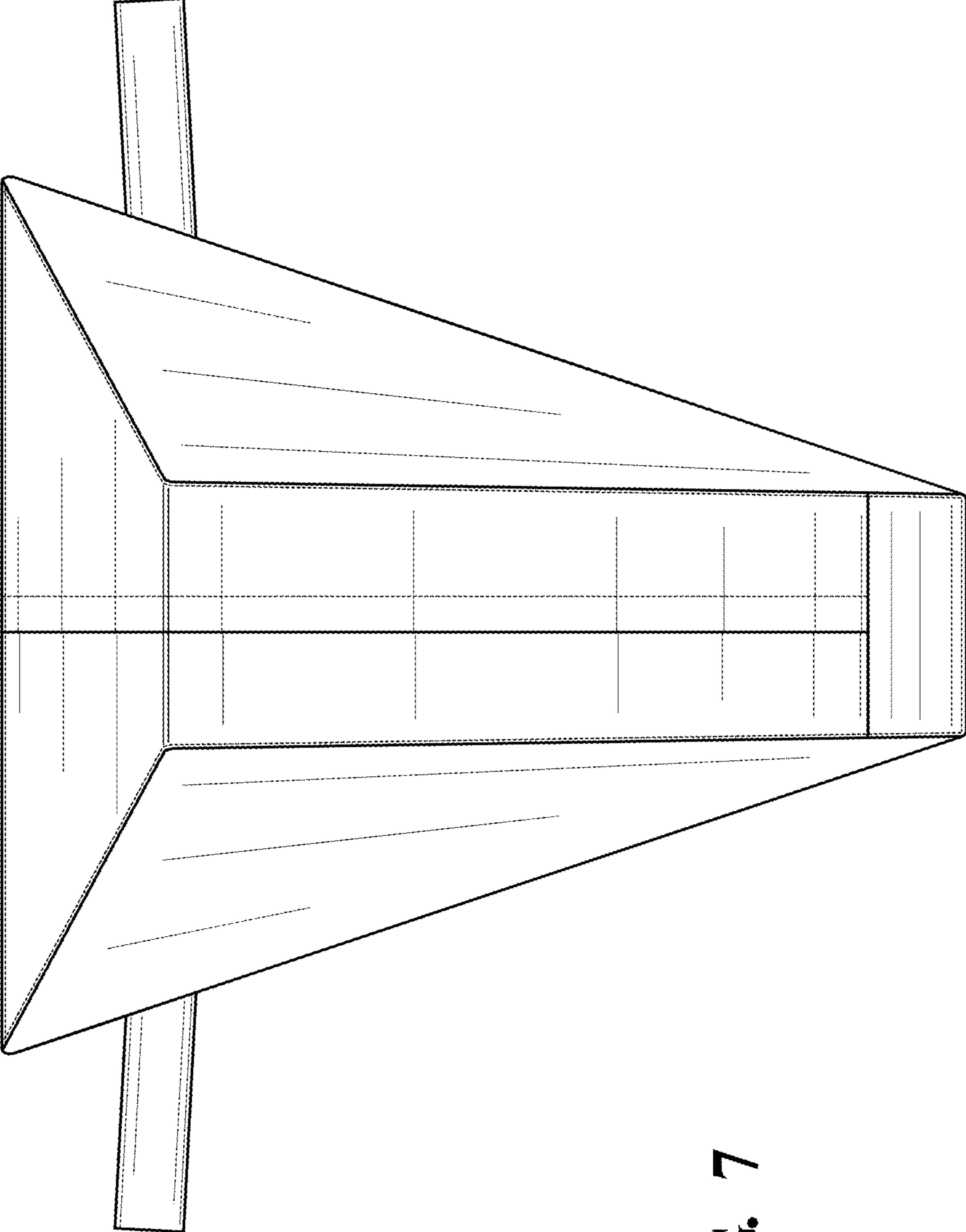

FIG. 7

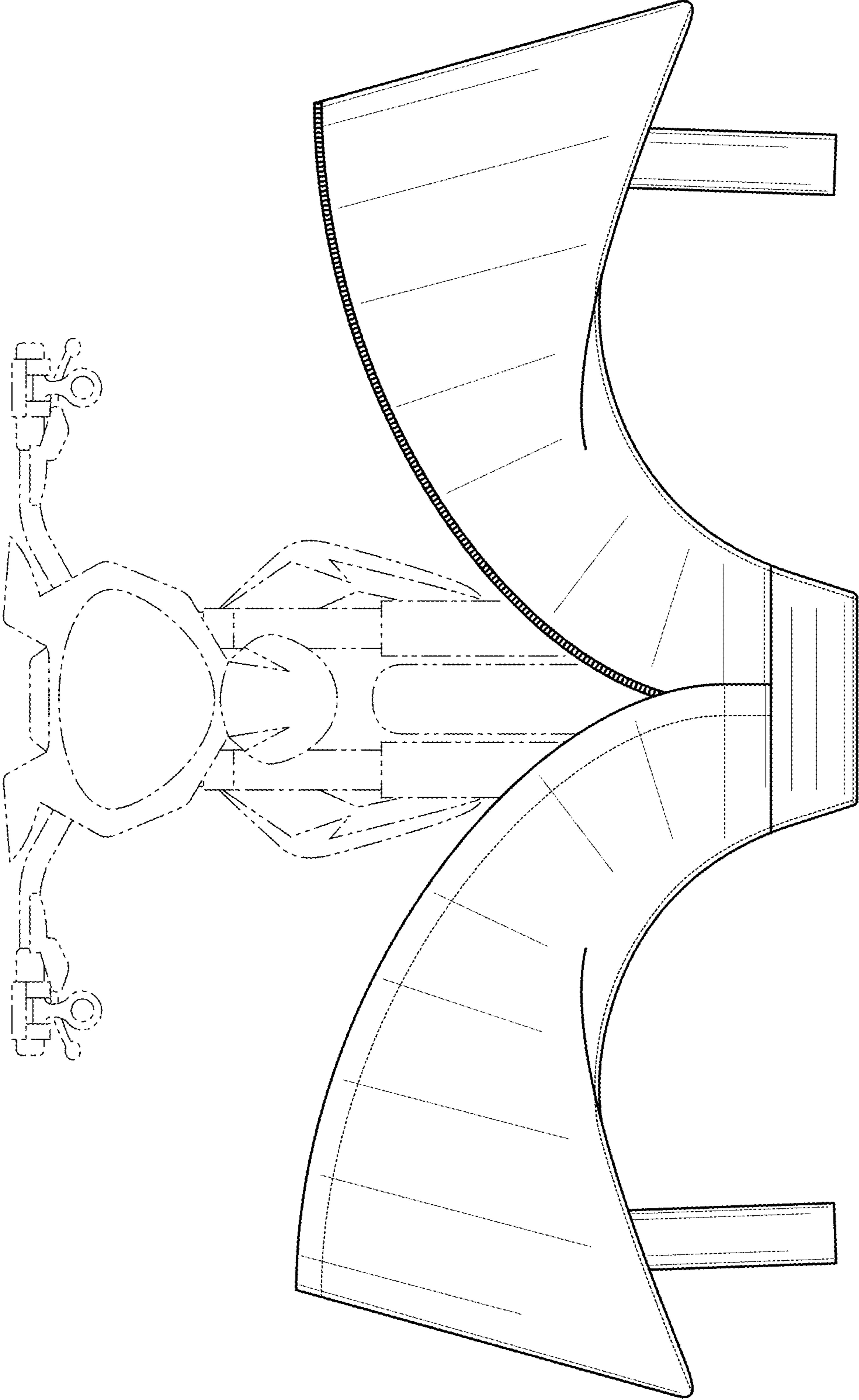
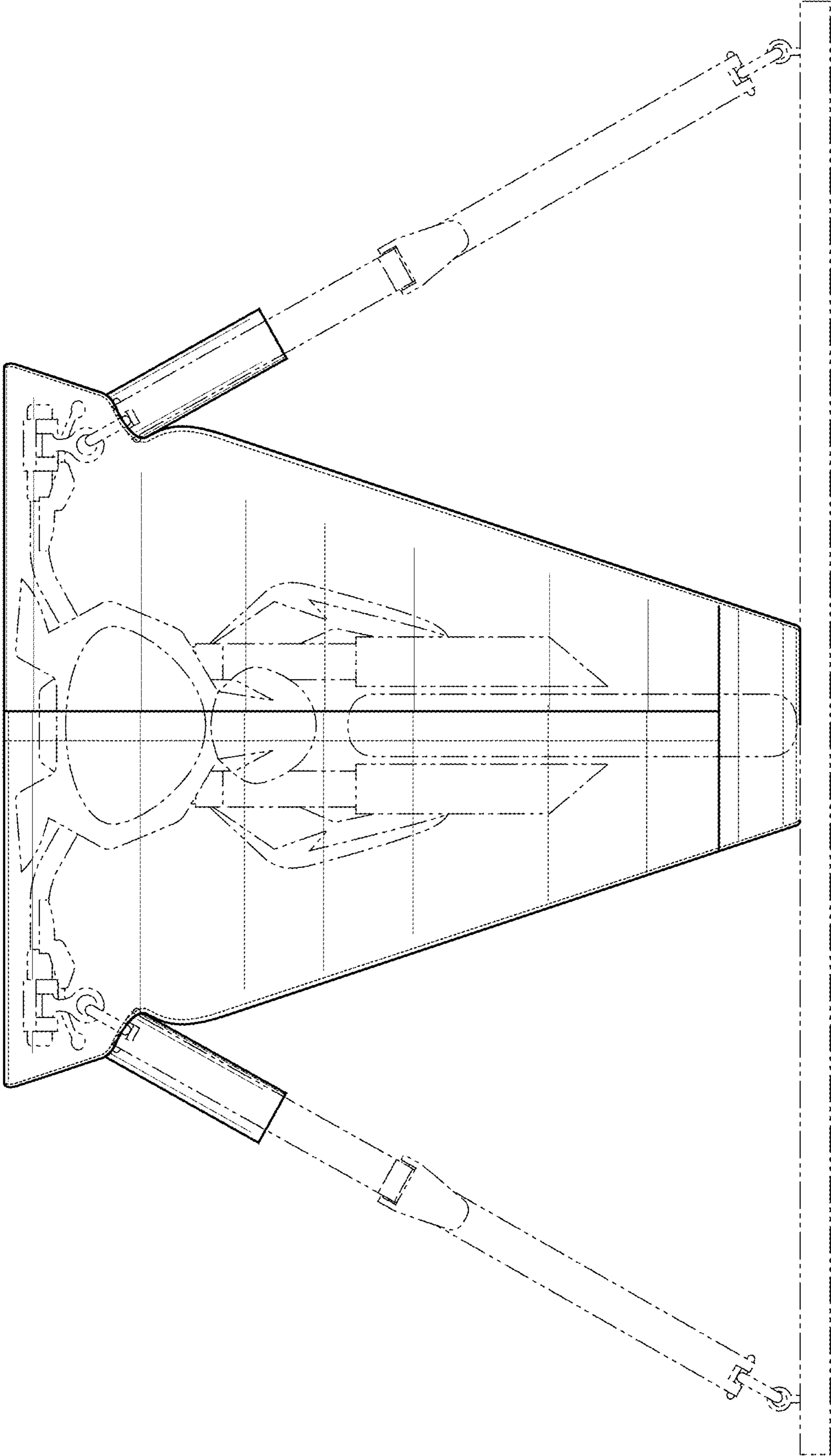

FIG. 8

FIG. 9



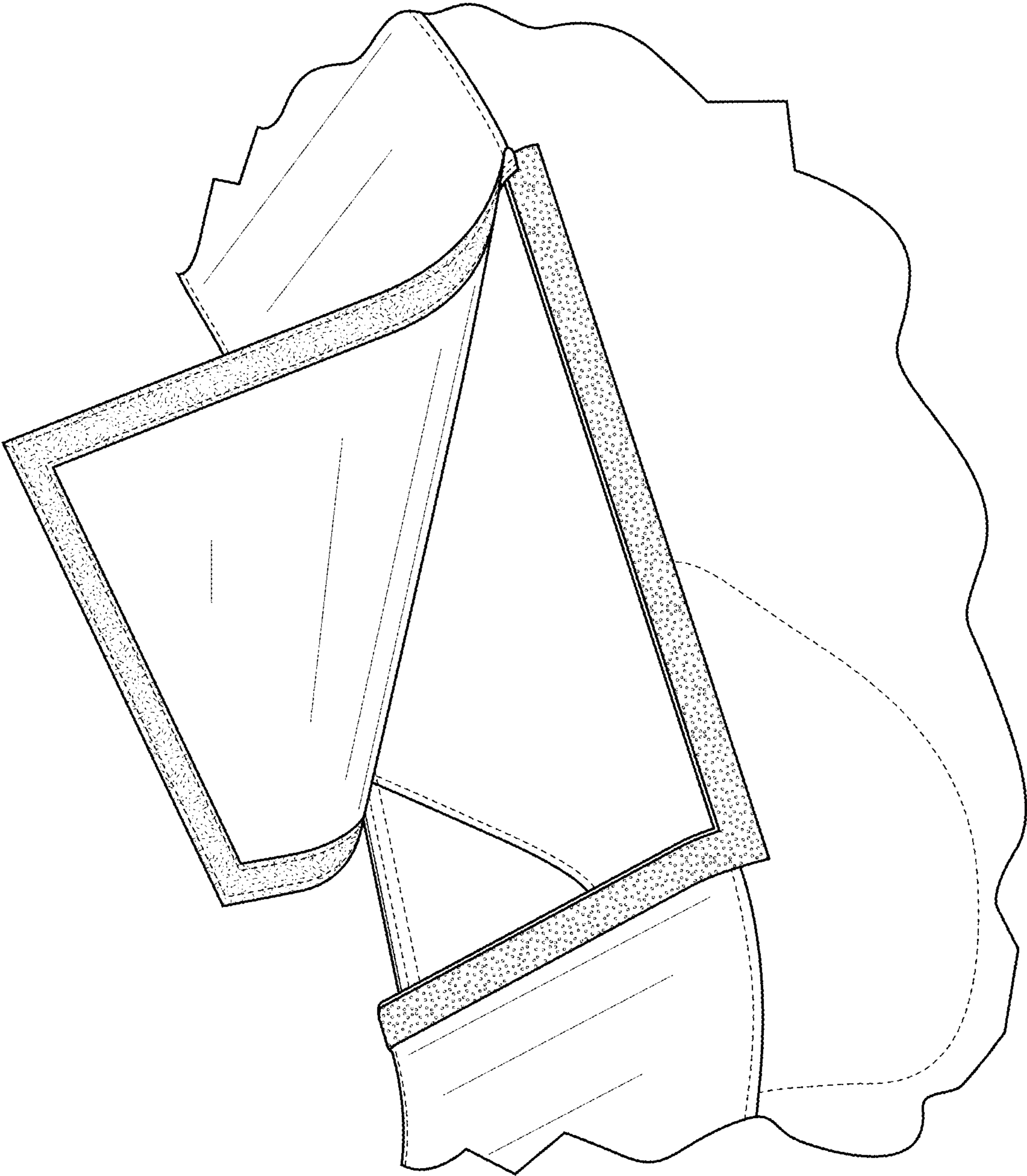

FIG. 10

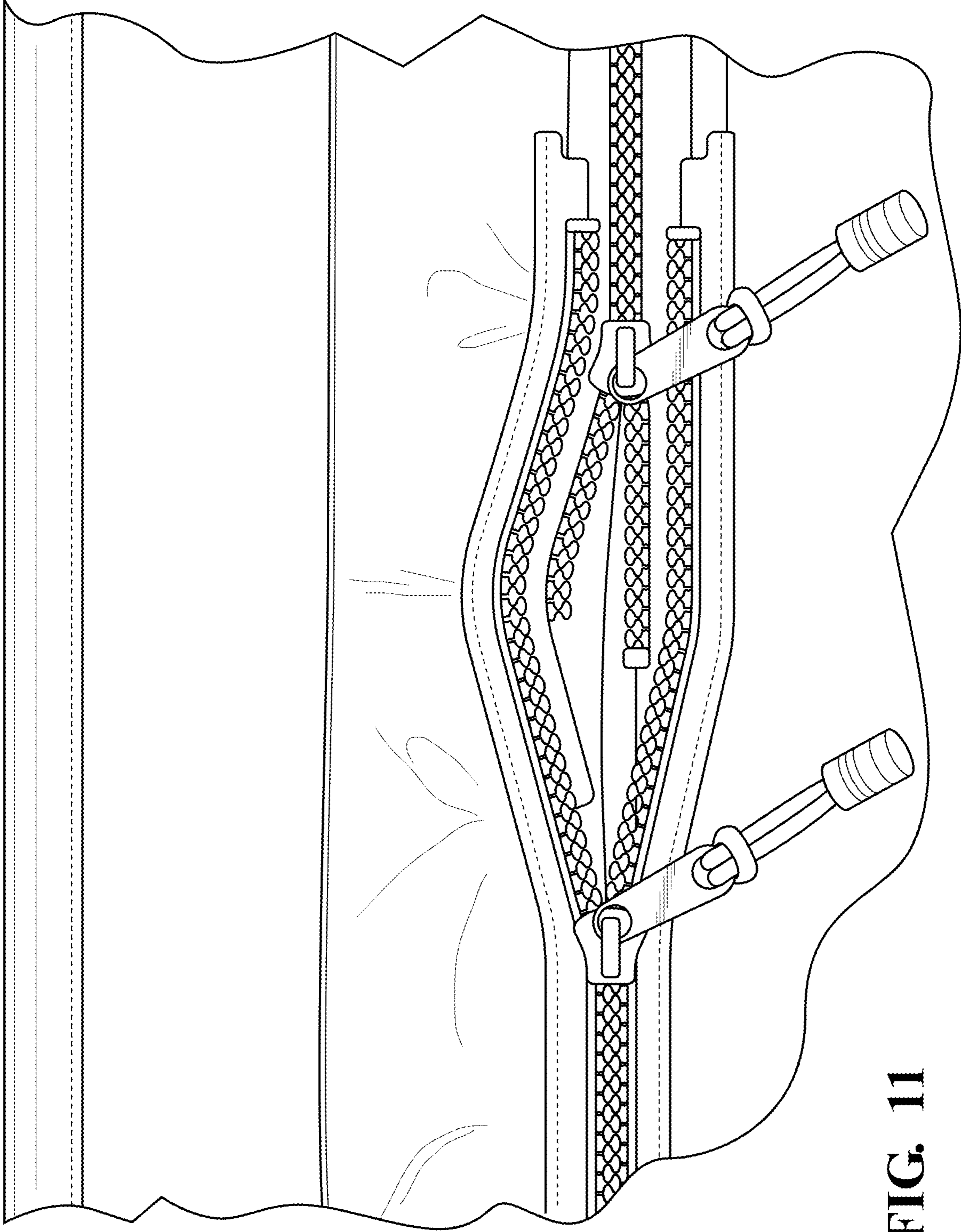

FIG. 11

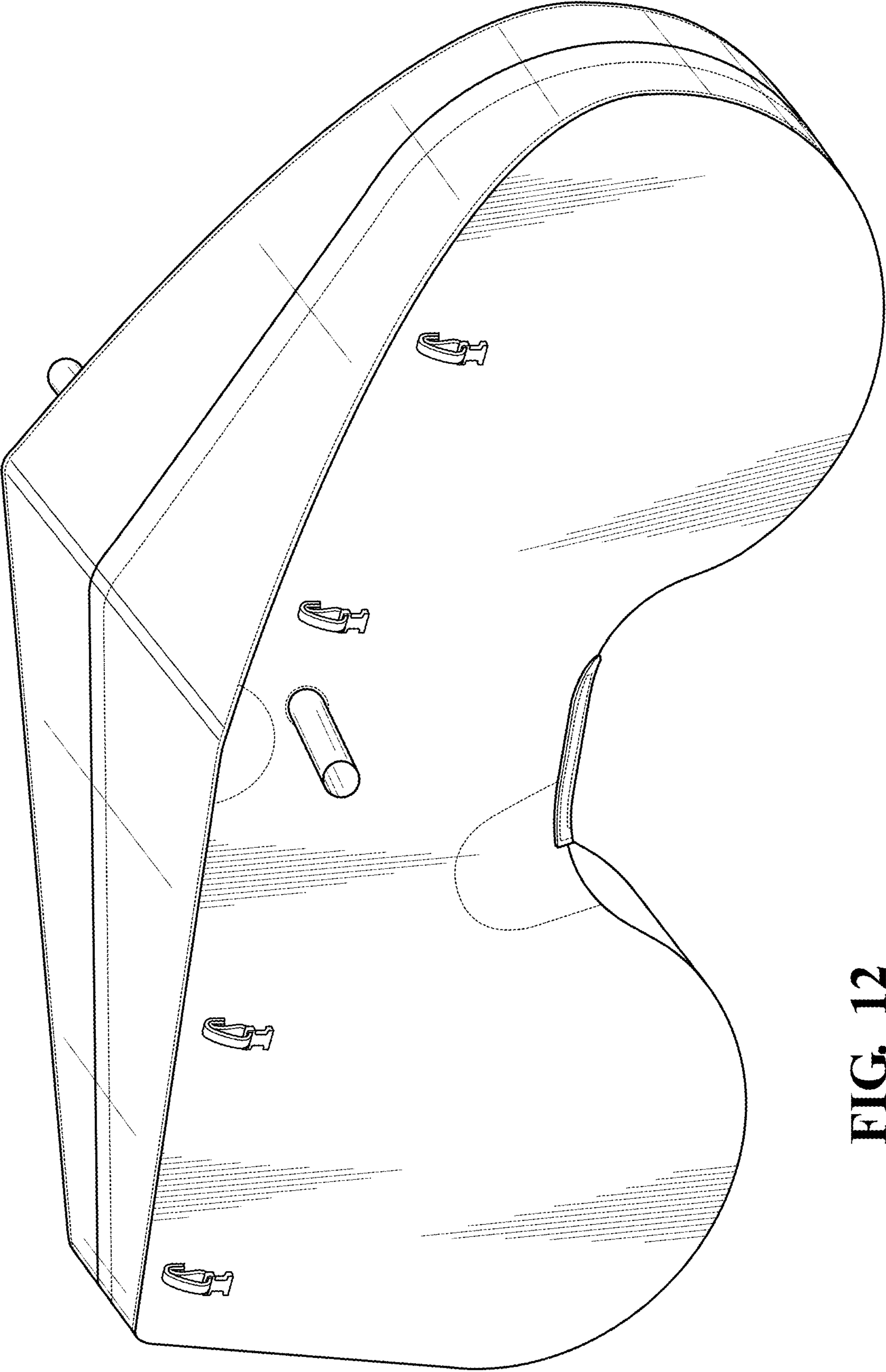

FIG. 12