



US00D906917S

(12) **United States Design Patent** (10) **Patent No.:** **US D906,917 S**
Akrapovic et al. (45) **Date of Patent:** **** Jan. 5, 2021**

(54) **MUFFLER FOR MOTOR VEHICLES**
(71) Applicant: **Igor Akrapovic**, Ljubljana (SI)
(72) Inventors: **Igor Akrapovic**, Ljubljana (SI); **Ermin Kosovel**, Zgornje Gorje (SI); **Alojz Trstenjak**, Ljubljana (SI); **Marko Besal**, Smarjeske Toplice (SI); **Roman Hafnar**, Zabnica (SI)
(**) Term: **15 Years**
(21) Appl. No.: **35/508,036**
(22) Filed: **Sep. 3, 2019**
(80) **Hague Agreement Data**
Int. Filing Date: **Sep. 3, 2019**
Int. Reg. No.: **DM/204424**
Int. Reg. Date: **Sep. 3, 2019**
Int. Reg. Pub. Date: **Dec. 6, 2019**

(30) **Foreign Application Priority Data**
Mar. 19, 2019 (EM) 006315388-0001
(51) **LOC (13) Cl.** **12-16**
(52) **U.S. Cl.**
USPC **D12/194**
CPC **F01N 13/20** (2013.01)
(58) **Field of Classification Search**
USPC D23/205, 209, 323, 330; D15/5;
D12/194
CPC ... F01N 1/00; F01N 1/003; F01N 1/02; F01N
1/04; F01N 1/10; F01N 1/24; F01N
13/08; F01N 13/082; F01N 13/085; F01N
13/087; F01N 13/20; F01N 13/16
See application file for complete search history.

(56) **References Cited**
U.S. PATENT DOCUMENTS
D246,038 S * 10/1977 Moller D12/194
6,431,311 B1 * 8/2002 Brown F01N 13/082
181/227

D467,210 S * 12/2002 Yu D12/194
D480,030 S * 9/2003 Gilli D12/194
D490,036 S * 5/2004 Cho D12/194
D495,642 S * 9/2004 Luttig D12/194
D496,313 S * 9/2004 Suzuki D12/194
D541,718 S * 5/2007 Emler D12/194
D550,134 S * 9/2007 Akrapovic D12/194
D573,520 S * 7/2008 Kouchi D12/194
D573,521 S * 7/2008 Hsu D12/194
D578,050 S * 10/2008 Hsu D12/194
D589,422 S * 3/2009 Davis, Jr. D12/194
D597,915 S * 8/2009 Bhambra D12/194
D654,839 S * 2/2012 Contreras D12/194
8,439,159 B1 * 5/2013 Borla F01N 1/083
181/257
D689,420 S * 9/2013 Chou D12/194
D709,012 S * 7/2014 Chou D12/194
D712,812 S * 9/2014 Verlengiere D12/194
D762,540 S * 8/2016 Yasuhara D12/194
D767,456 S * 9/2016 Finnie D12/194
D773,970 S * 12/2016 Kobayashi D12/194

(Continued)

Primary Examiner — Richard E Chilcot
(74) *Attorney, Agent, or Firm* — Olson & Cepuritis, Ltd.;
William P. Oberhardt; Shawn E. Duckworth

(57) **CLAIM**

The ornamental design for a muffler for motor vehicle, as shown and described.

DESCRIPTION

- 1. Muffler for motor vehicles
- 1.1 : Perspective
- 1.2 : Right
- 1.3 : Left
- 1.4 : Perspective
- 1.5 : Top
- 1.6 : Bottom
- 1.7 : Back
- 1.8 : Front
- 1.9 : Perspective

1 Claim, 9 Drawing Sheets

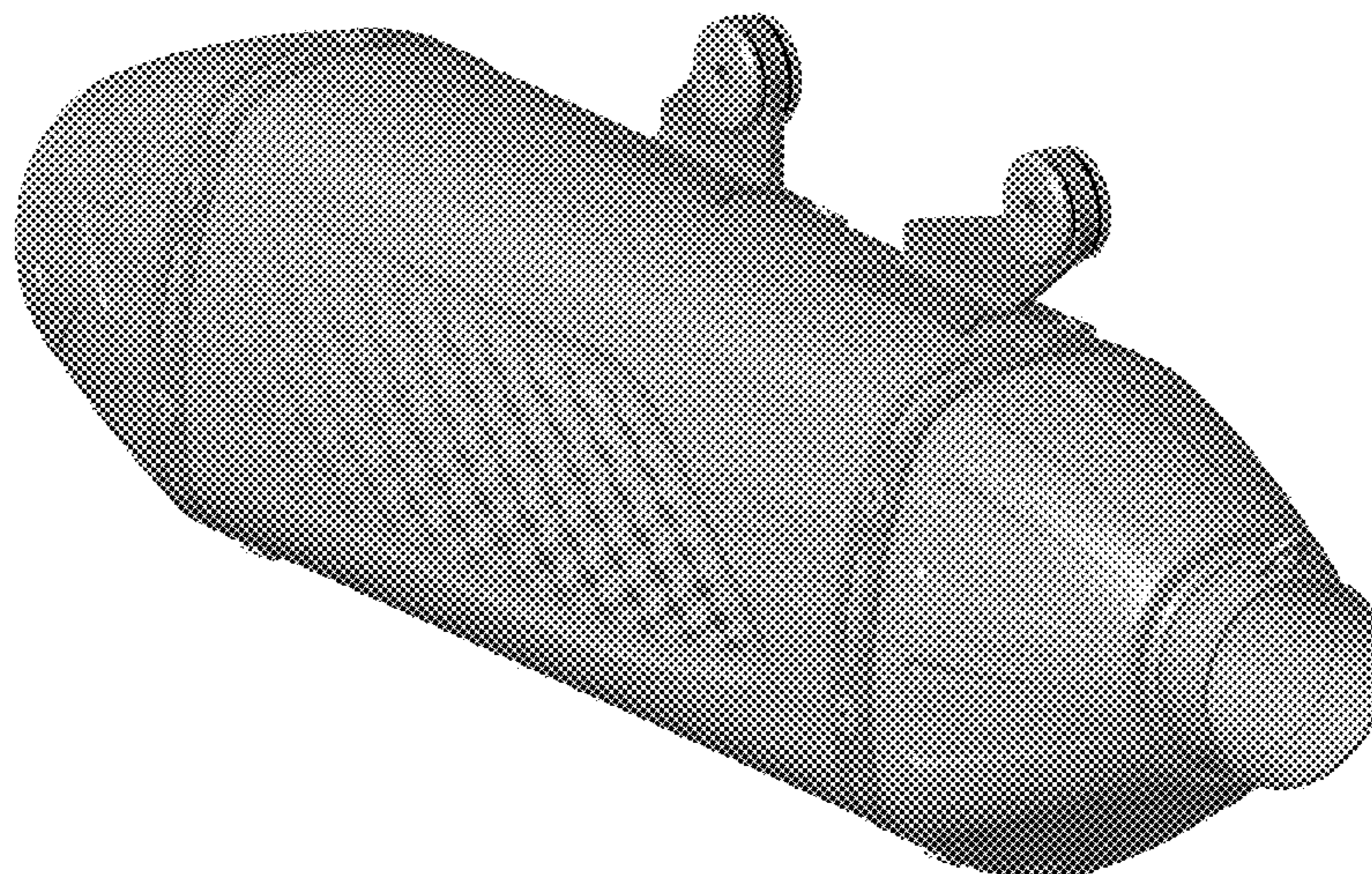

(56)

References Cited

U.S. PATENT DOCUMENTS

D798,884 S * 10/2017 Kaasalainen G06F 3/04817
D14/485
D804,381 S * 12/2017 Akrapovic D12/194
D804,382 S * 12/2017 Akrapovic D12/194
D804,383 S * 12/2017 Akrapovic D12/194
D816,570 S * 5/2018 Akrapovic D12/194
D819,066 S * 5/2018 Anderson D14/486
D833,936 S * 11/2018 Akrapovic D12/194
D836,514 S * 12/2018 Akrapovic D12/194
D837,119 S * 1/2019 Akrapovic D12/194
D852,821 S * 7/2019 Anderson D14/485
10,437,845 B2 * 10/2019 Anderson G06F 16/248
D875,009 S * 2/2020 Akrapovic D12/194
D875,010 S * 2/2020 Akrapovic D12/194
D877,763 S * 3/2020 Inman D14/486
D895,502 S * 9/2020 Marovic D12/194
2004/0089500 A1 * 5/2004 Lewis F01N 13/18
181/249
2008/0121456 A1 * 5/2008 Davis F01N 13/20
180/309

* cited by examiner

1.1



1.2

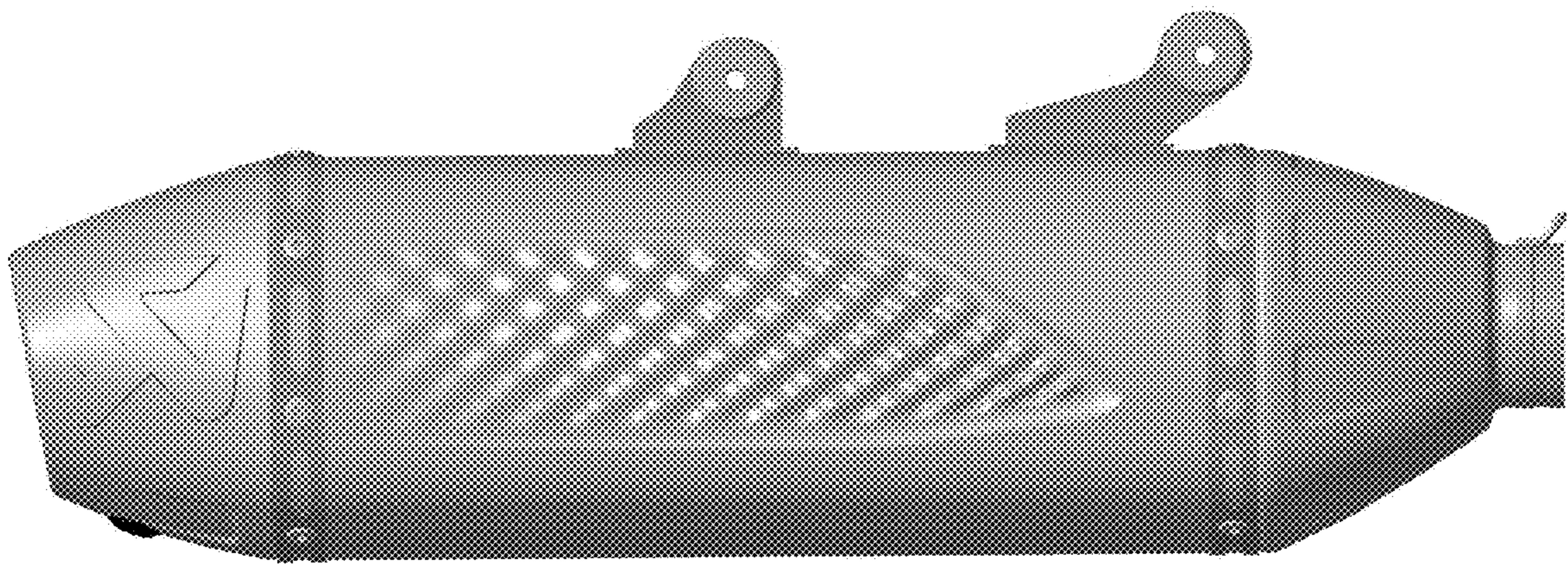

1.3

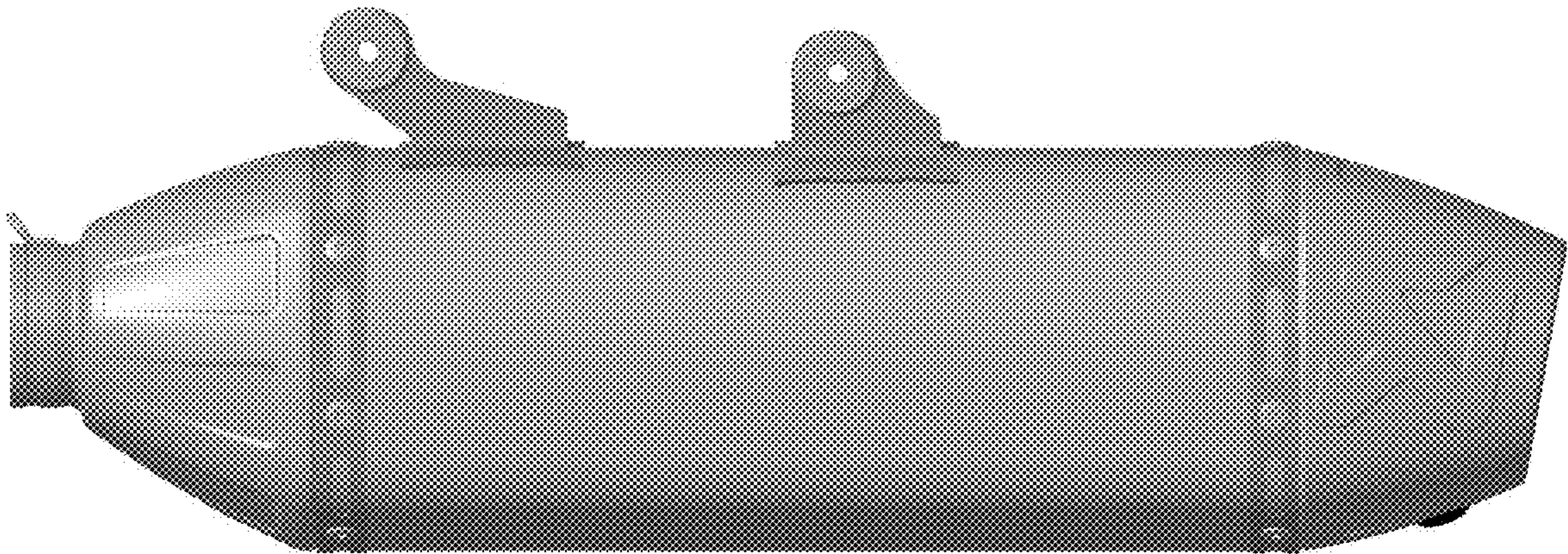

1.4

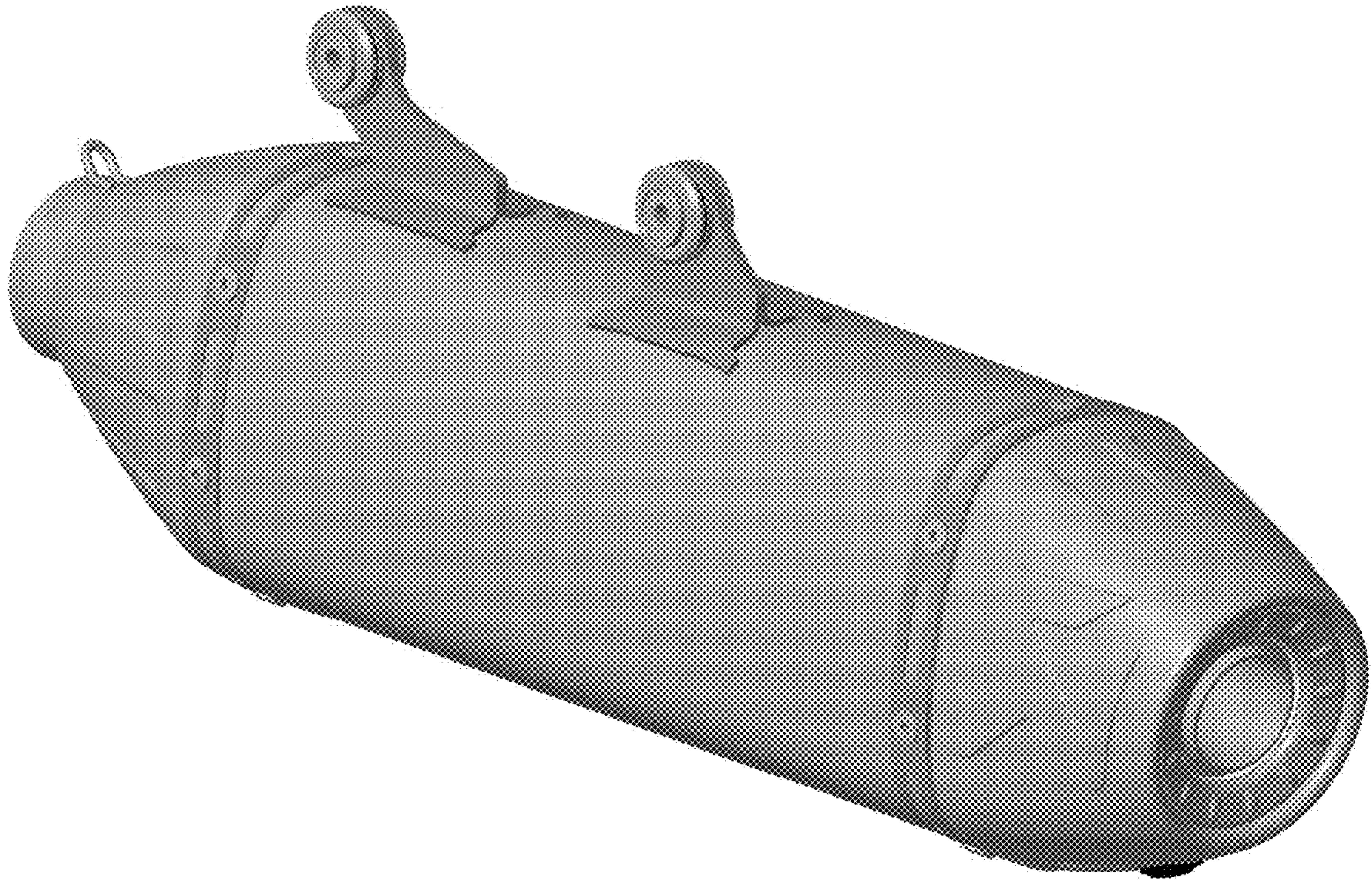

1.5

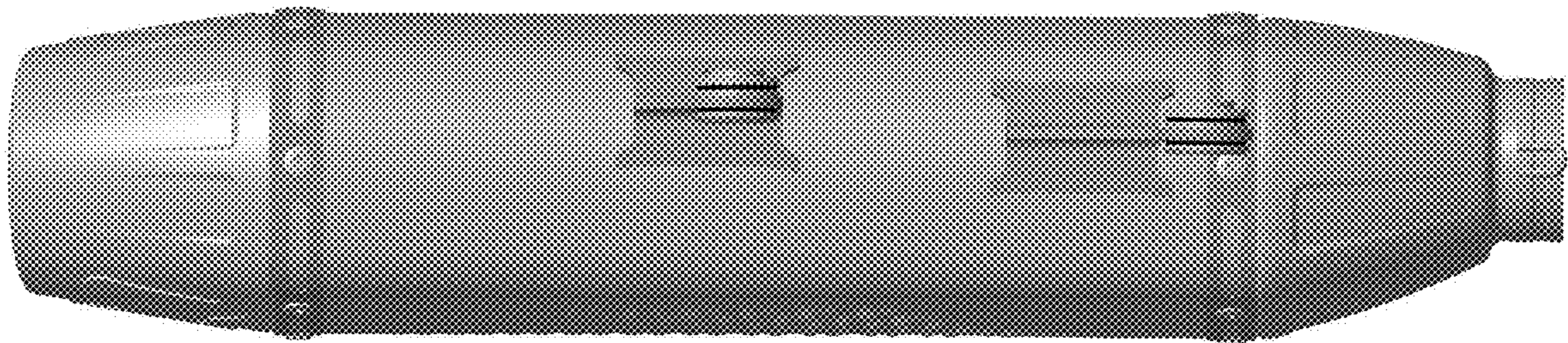

1.6

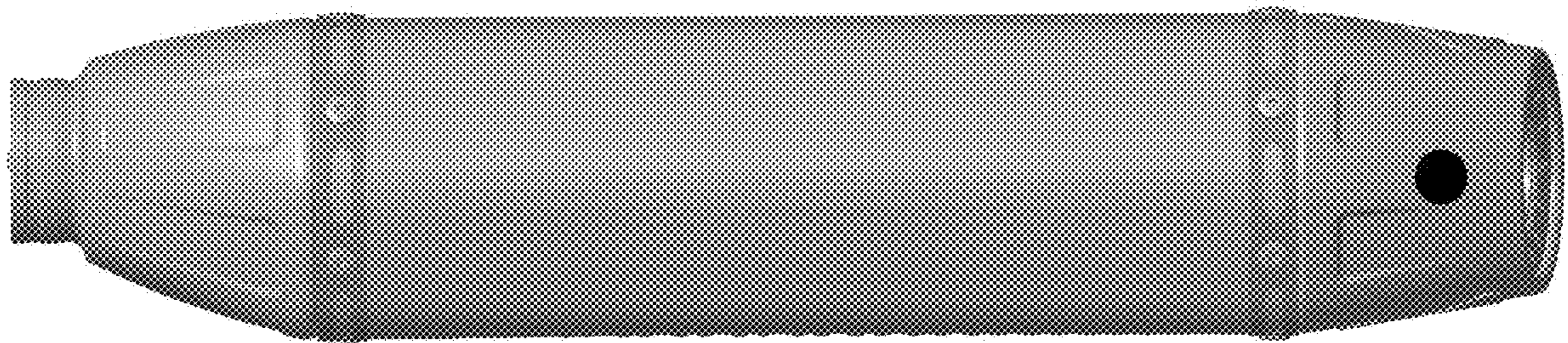

1.7

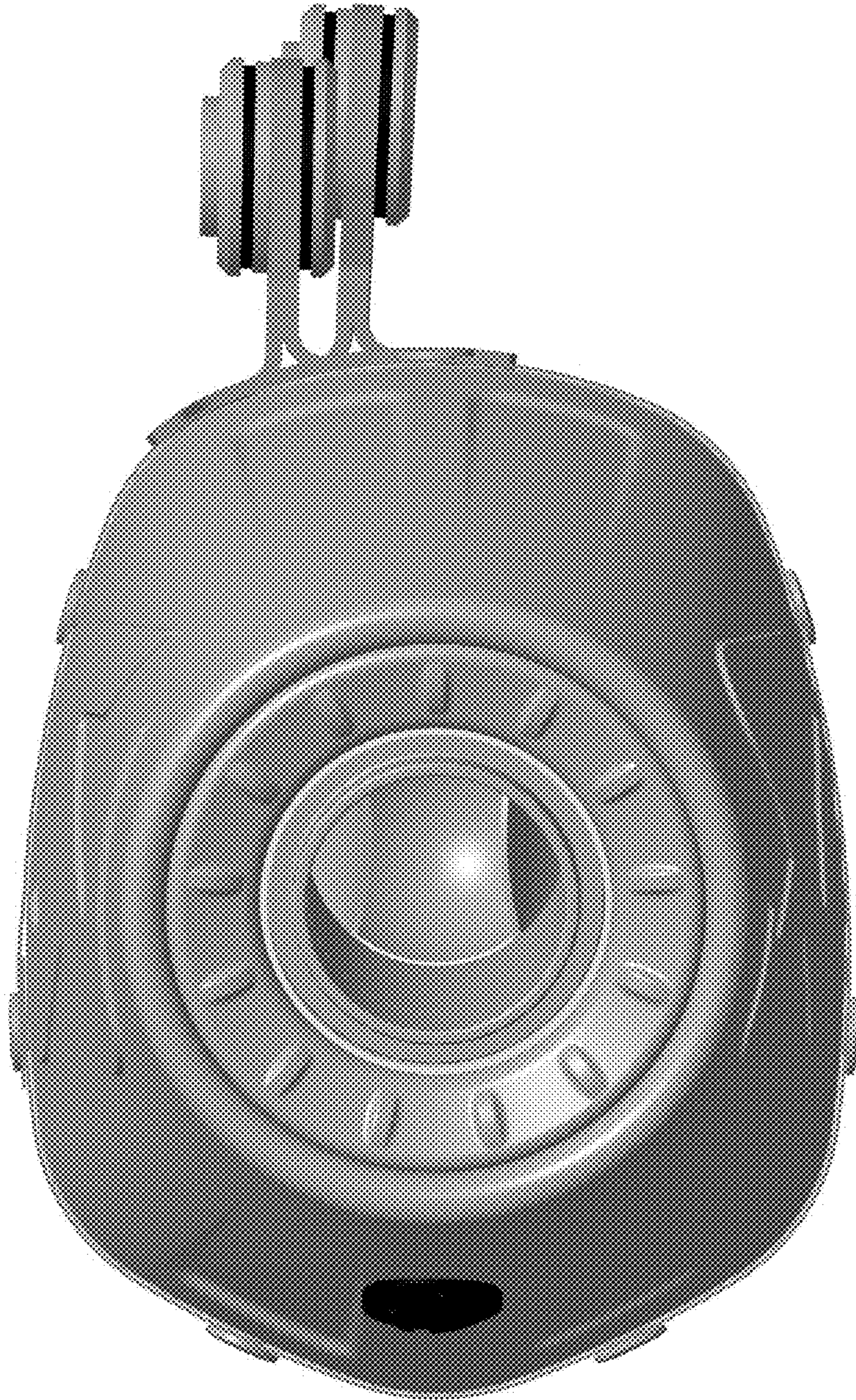

1.8

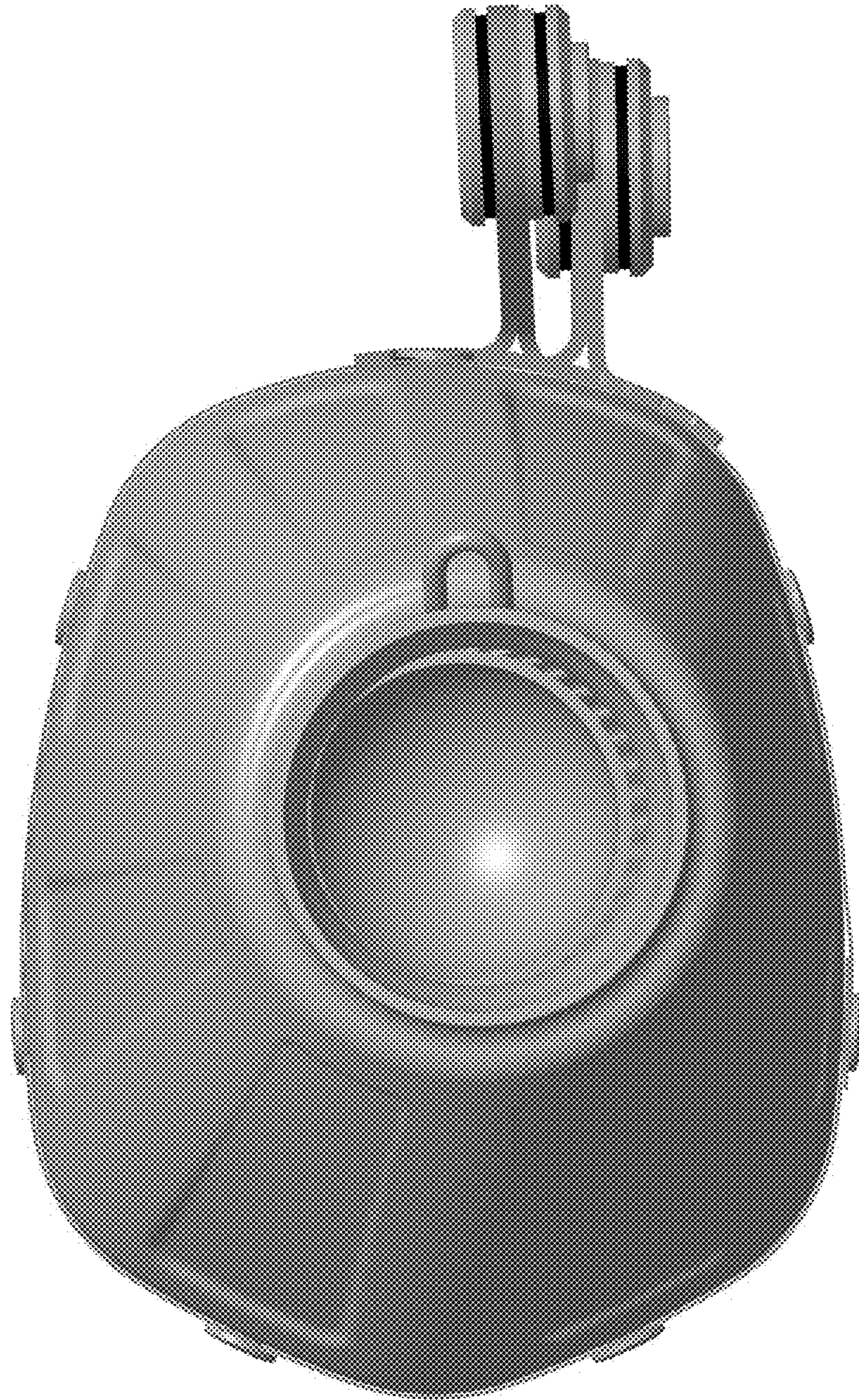

1.9

