



US00D906916S

(12) **United States Design Patent**
Tsai

(10) **Patent No.:** **US D906,916 S**

(45) **Date of Patent:** **** Jan. 5, 2021**

(54) **LICENSE PLATE BOX**

D886,699 S * 6/2020 Xu D12/193
D886,700 S * 6/2020 Xu D12/193

(71) Applicant: **Stay Tuned Performance**, Walnut, CA
(US)

* cited by examiner

(72) Inventor: **Yaw Hong Tsai**, Hacienda Heights, CA
(US)

Primary Examiner — Natasha Vujcic

(74) *Attorney, Agent, or Firm* — Tommy S F Wang;
Wang IP Law Group, P.C.

(**) Term: **15 Years**

(57) **CLAIM**

The ornamental design for a license plate box, as shown and described.

(21) Appl. No.: **29/712,481**

DESCRIPTION

(22) Filed: **Nov. 8, 2019**

(51) **LOC (13) Cl.** **12-16**

(52) **U.S. Cl.**
USPC **D12/193**

(58) **Field of Classification Search**
USPC D12/193; D6/300, 301, 302, 310, 311,
D6/312, 313, 314; D20/13
CPC B60R 13/10; B60R 13/105; B60R 19/24;
B60R 19/52

See application file for complete search history.

FIG. 1 is a perspective view of a license plate box showing my new design;
FIG. 2 is a front view thereof;
FIG. 3 is a rear view thereof;
FIG. 4 is a left side view thereof;
FIG. 5 is a right side view thereof;
FIG. 6 is a top view thereof;
FIG. 7 is a bottom view thereof;
FIG. 8 is another perspective view thereof in an opened mode;
FIG. 9 is another front view thereof in the opened mode;
FIG. 10 is another rear view thereof in the opened mode;
FIG. 11 is another left side view thereof in the opened mode;
FIG. 12 is another right side view thereof in the opened mode;
FIG. 13 is another top view thereof in the opened mode;
FIG. 14 is another bottom view thereof in the opened mode;
and,
FIG. 15 is an enlarged view of an indicated portion of FIG. 8.

(56) **References Cited**

U.S. PATENT DOCUMENTS

D245,497 S *	8/1977	Ritch	D12/193
D247,962 S *	5/1978	Hunter	D12/193
D301,863 S *	6/1989	Iacovelli	D12/193
D327,915 S *	7/1992	Anderson	D12/193
D332,247 S *	1/1993	Wilson	D12/193
D370,450 S *	6/1996	Doan	D12/193
D382,240 S *	8/1997	Francis	D12/193
D489,031 S *	4/2004	Leibman	D12/193
D630,986 S *	1/2011	Spencer	D12/193
D824,307 S *	7/2018	Spencer	D12/193
D833,352 S *	11/2018	Reshetnyak	D12/193
D834,479 S *	11/2018	Spencer	D12/193
D859,010 S *	9/2019	Burch	D6/301
D870,624 S *	12/2019	Filakousky	D12/193

The broken line portions of the license plate box in FIGS. 1-15 represent unclaimed portions of the claimed design and form no part thereof. The dot-dash broken lines in FIGS. 8, 11-12 and 15 represent unclaimed boundary lines and form no part of the claimed design.

1 Claim, 13 Drawing Sheets

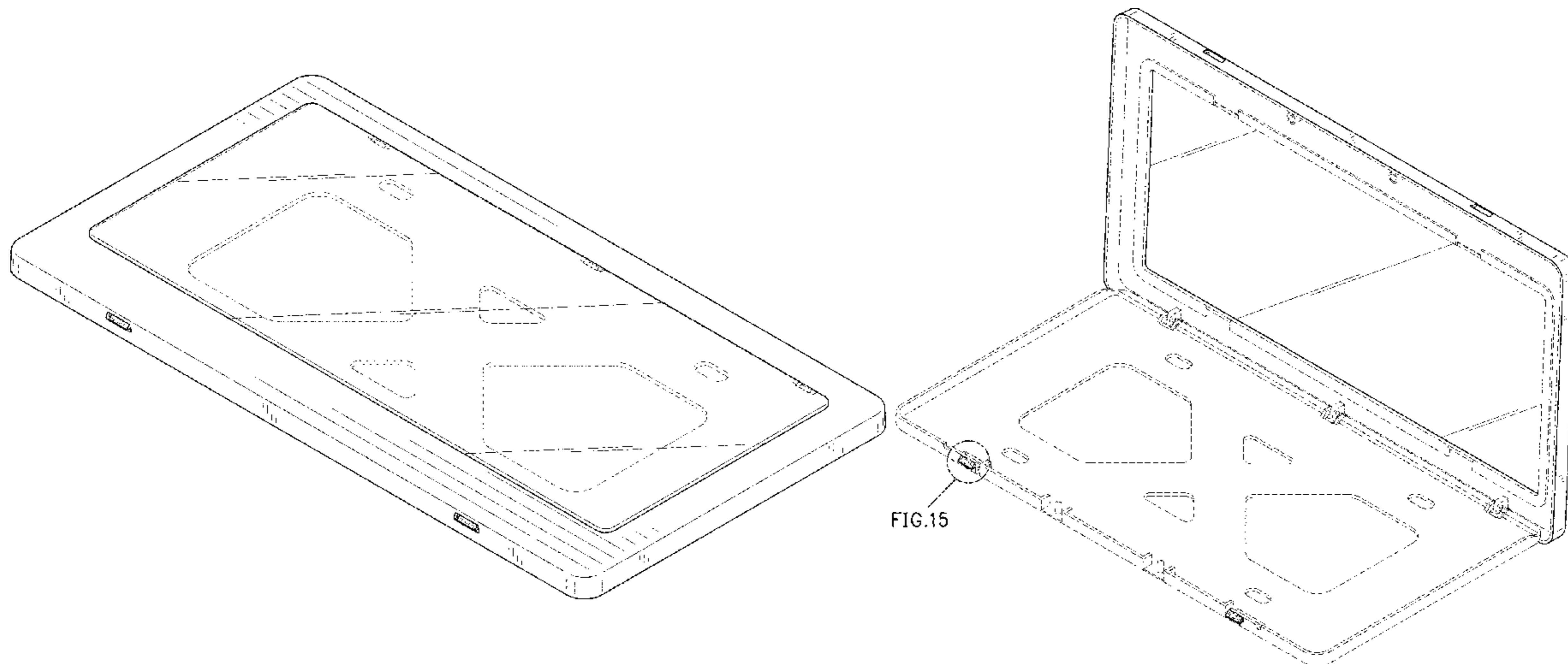

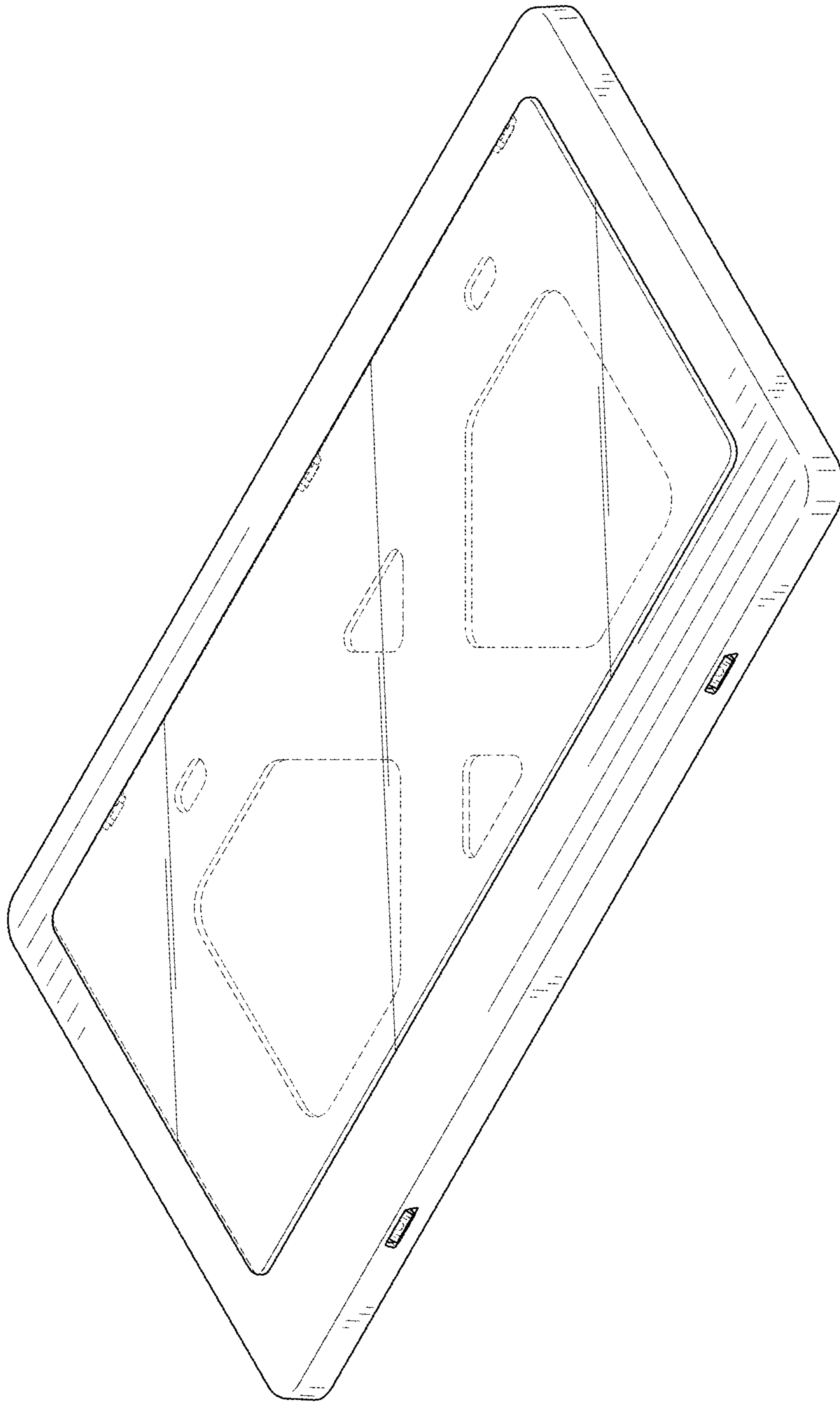

FIG. 1

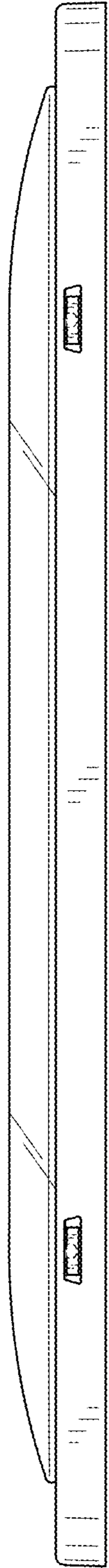

FIG. 2

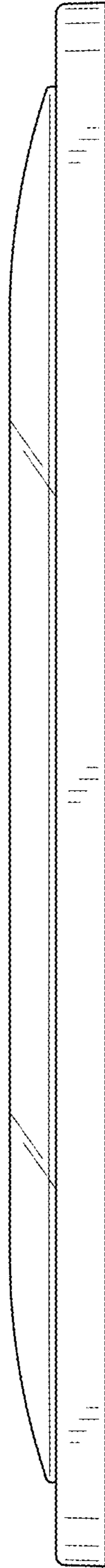

FIG. 3



FIG. 4

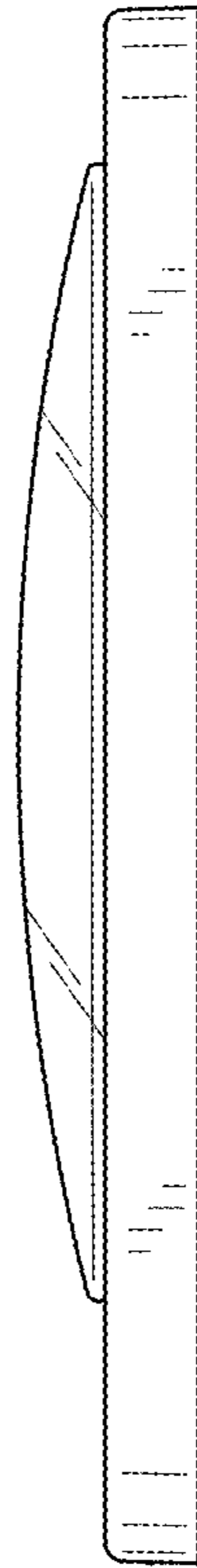

FIG. 5

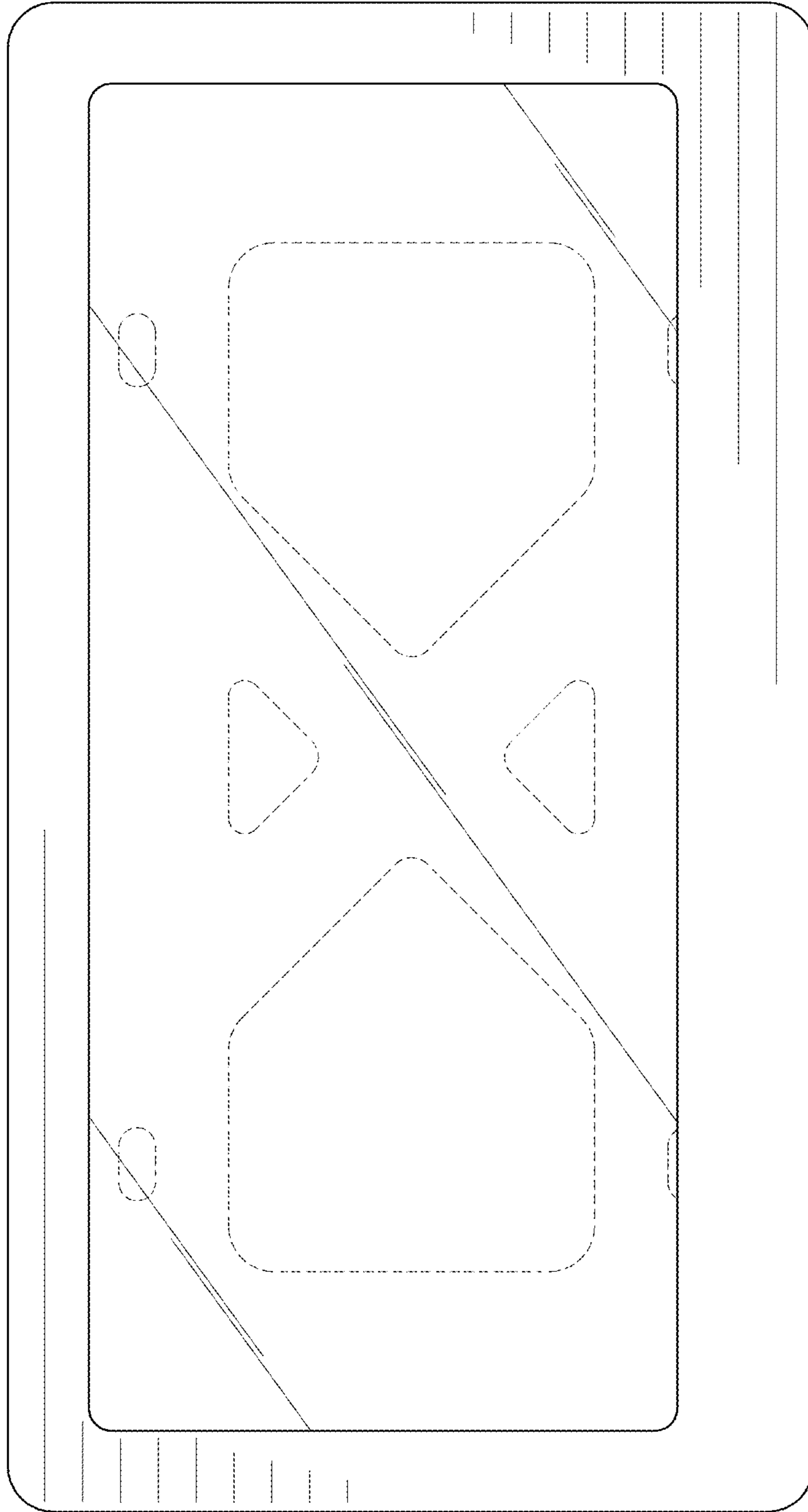

FIG. 6

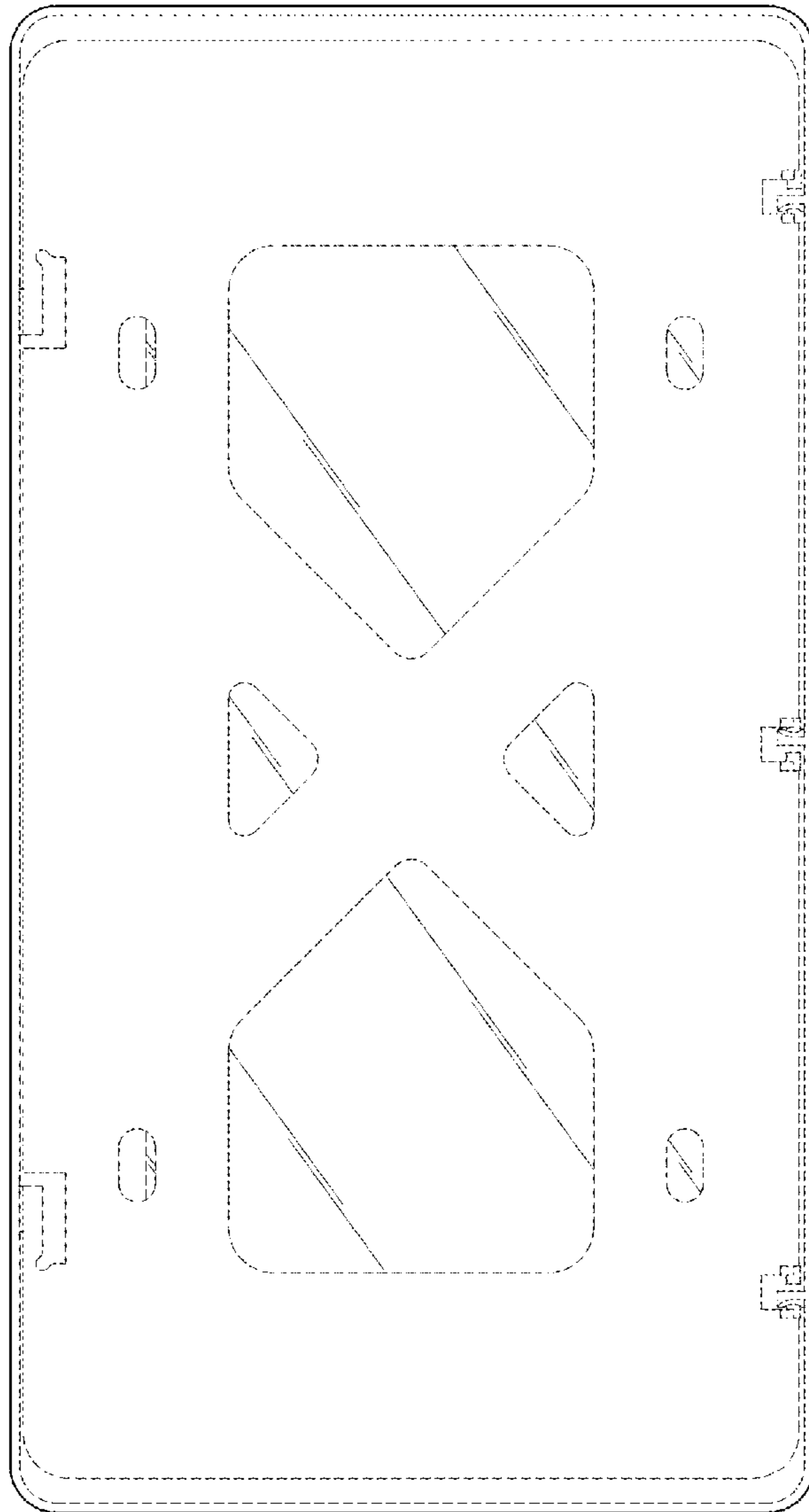

FIG. 7

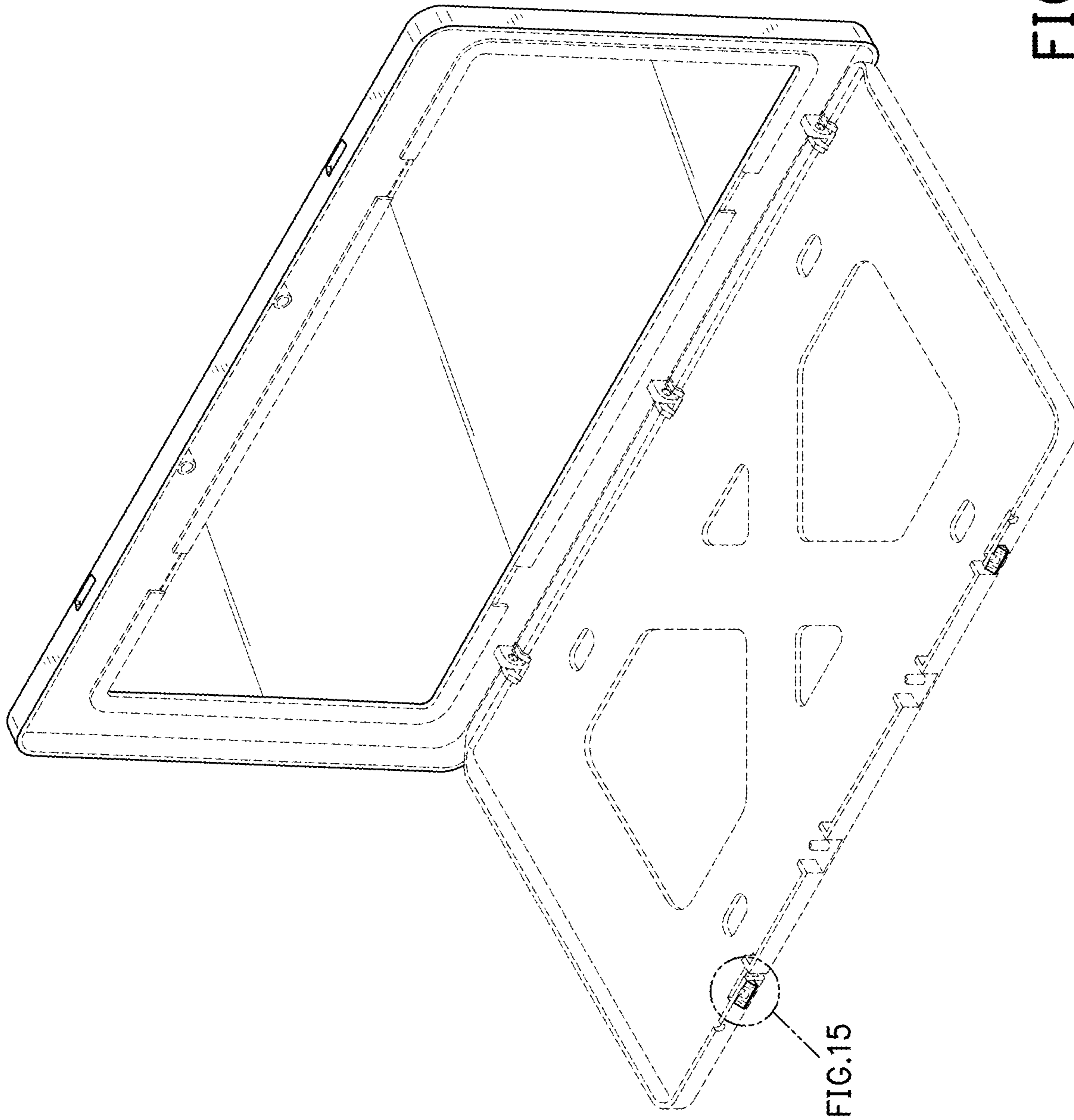

FIG. 8

FIG. 15

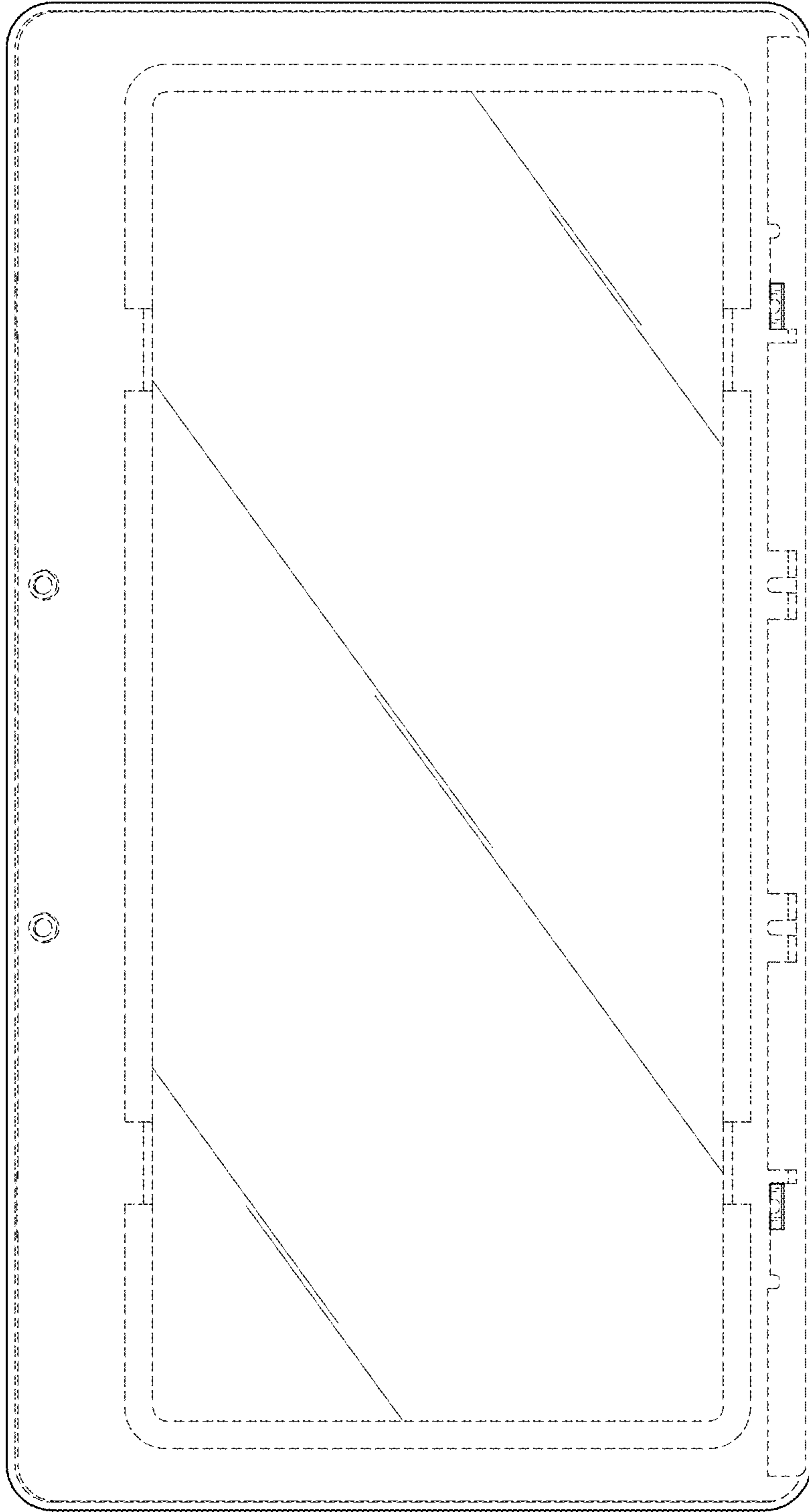

FIG. 9

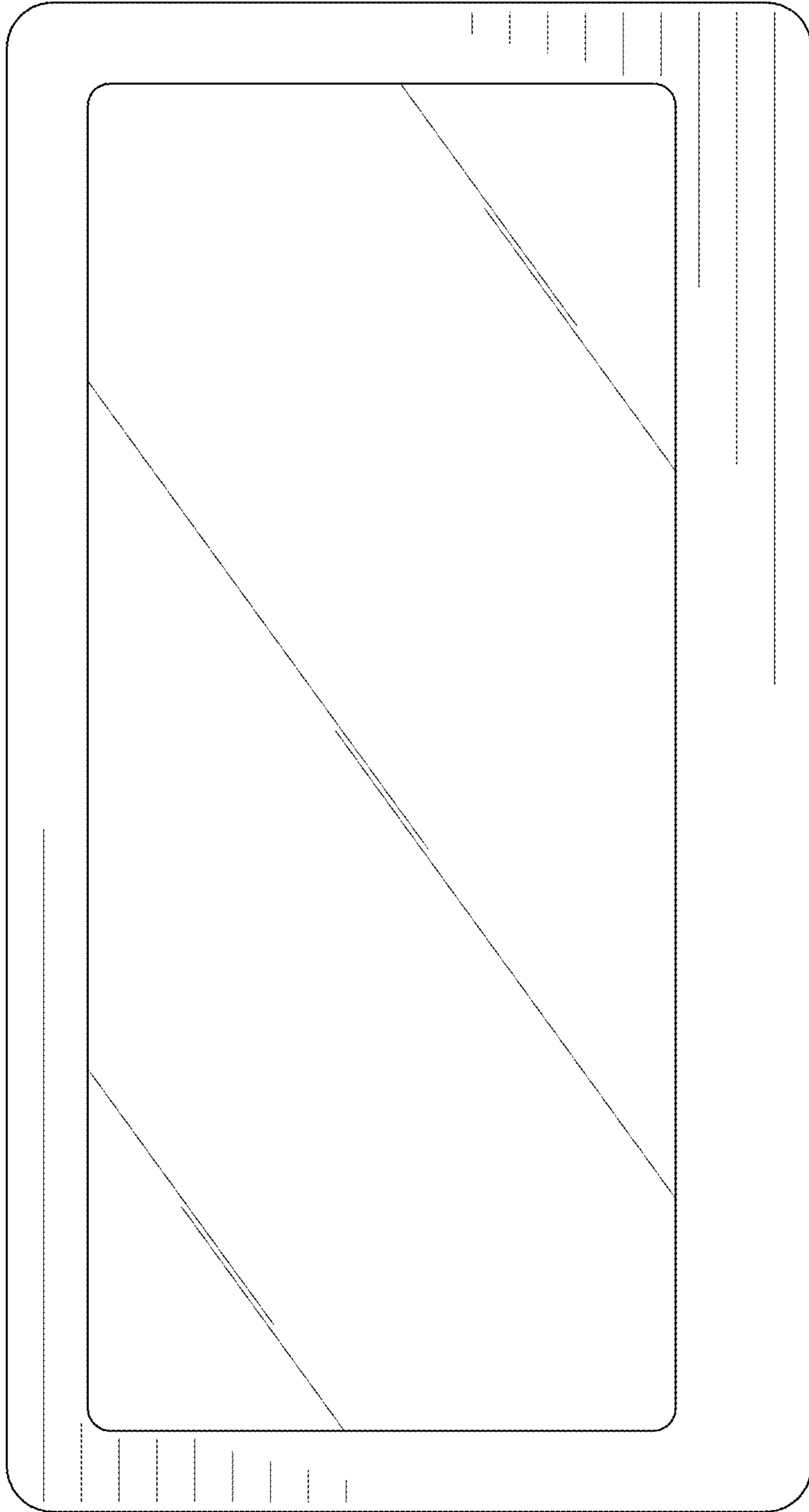

FIG. 10

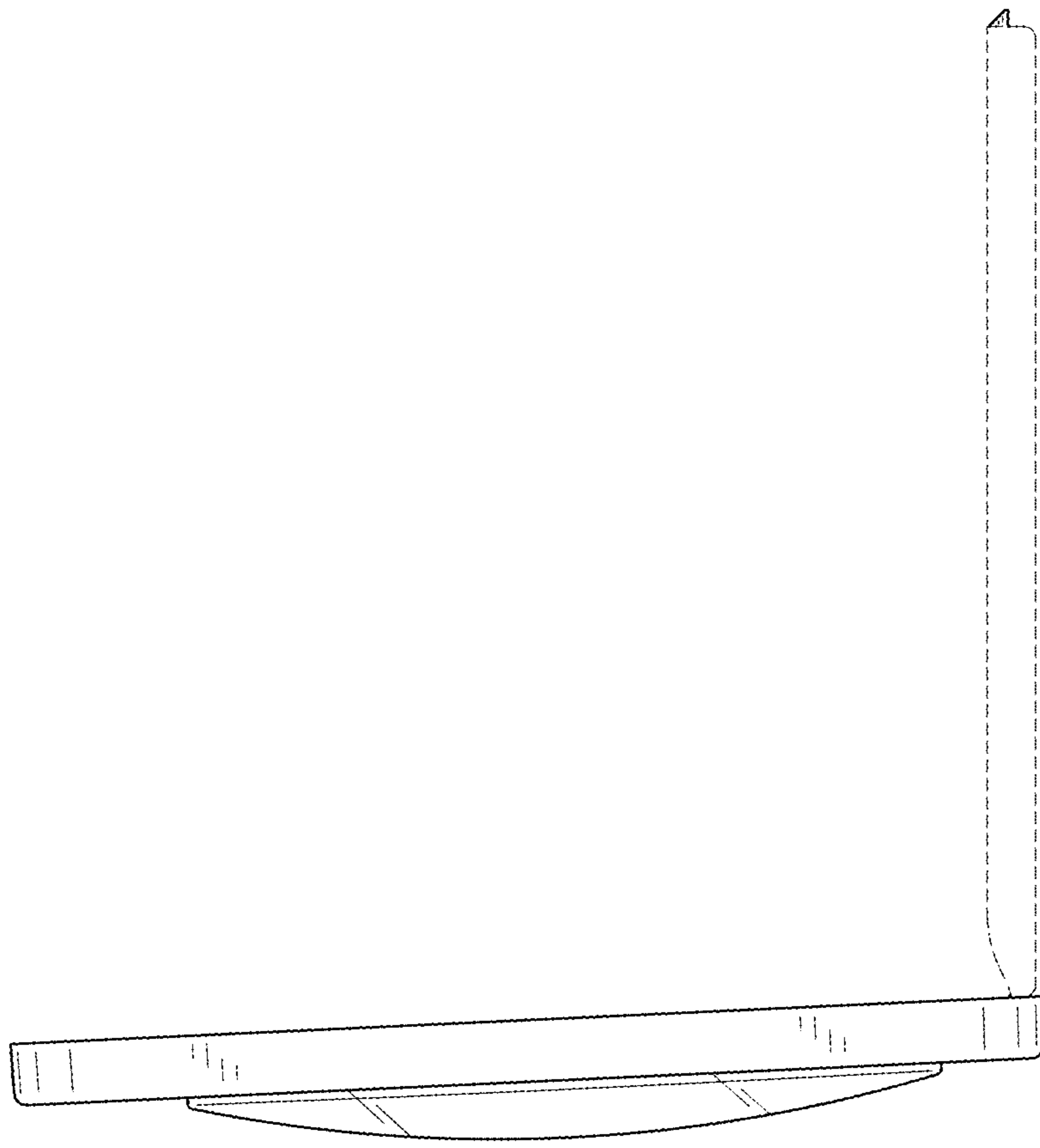

FIG. 11

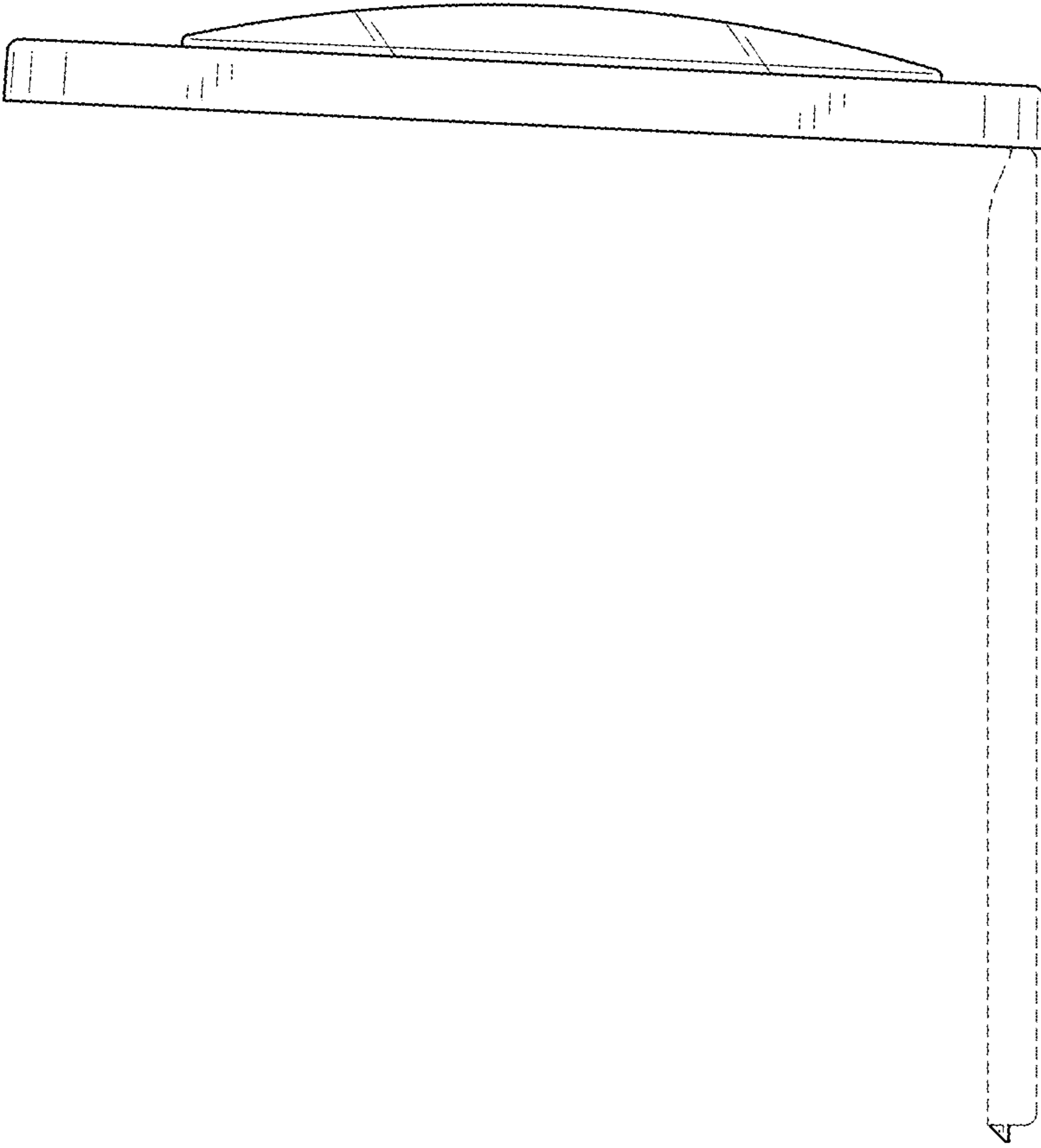

FIG. 12

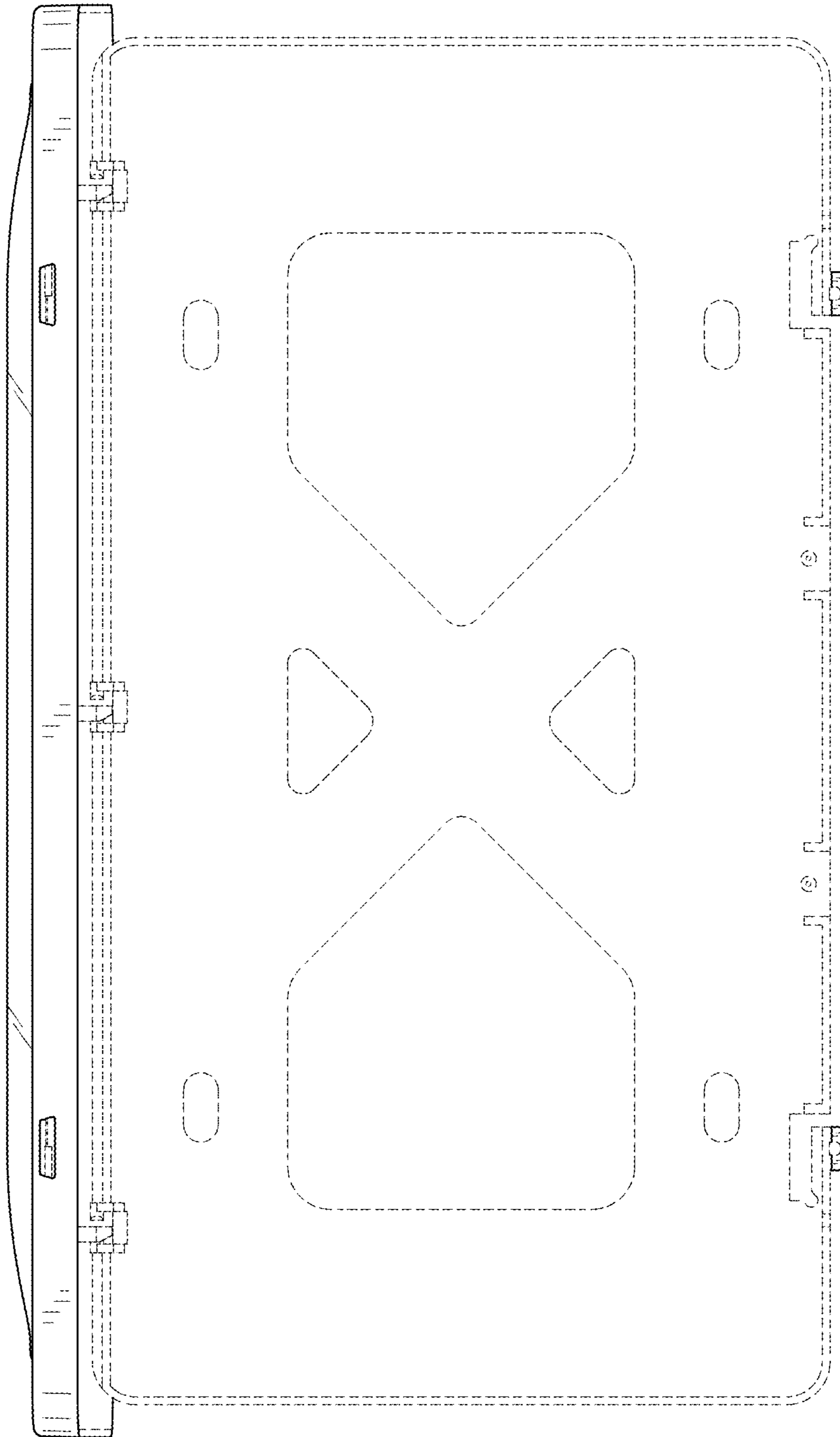

FIG. 13

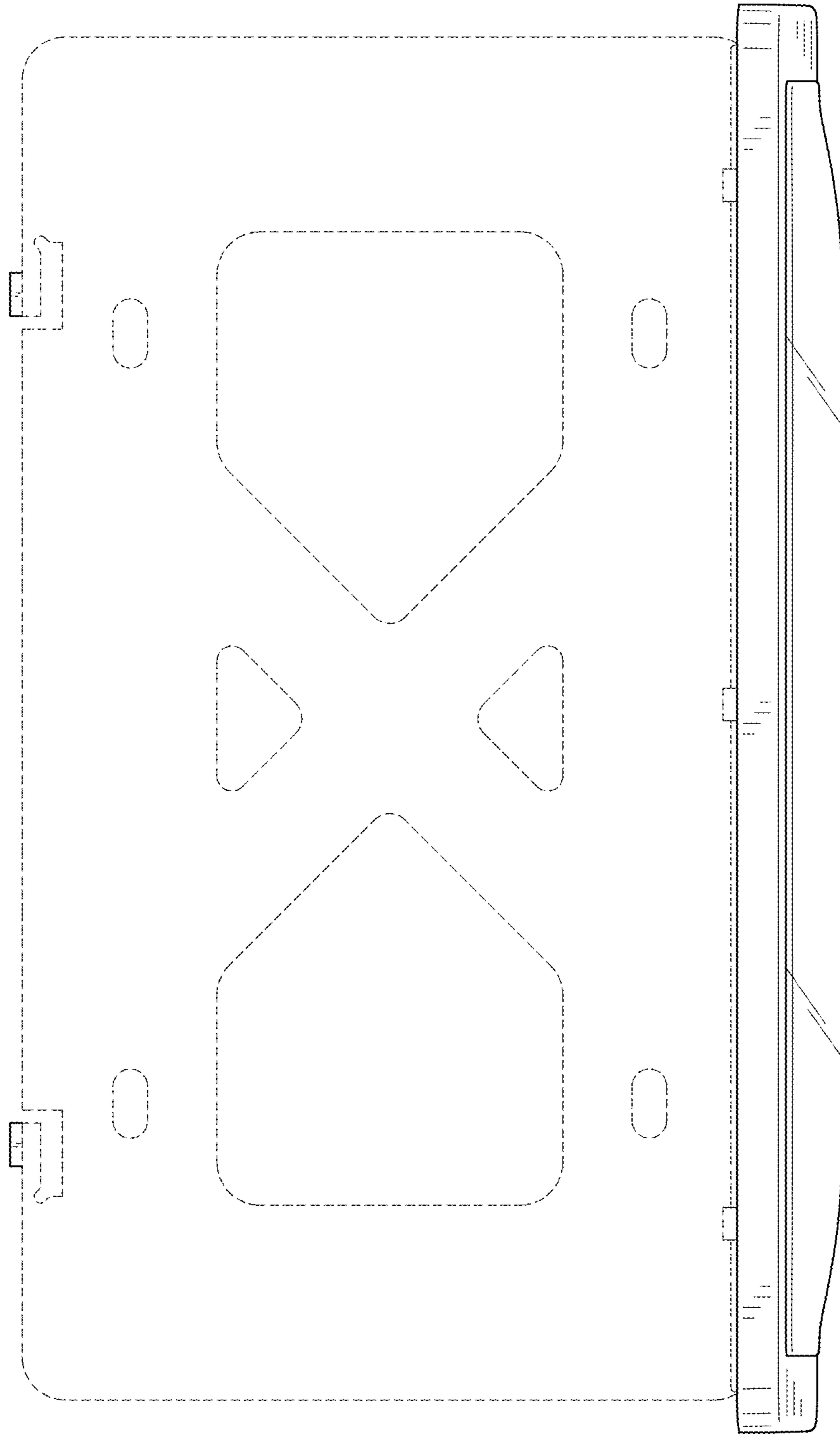

FIG. 14

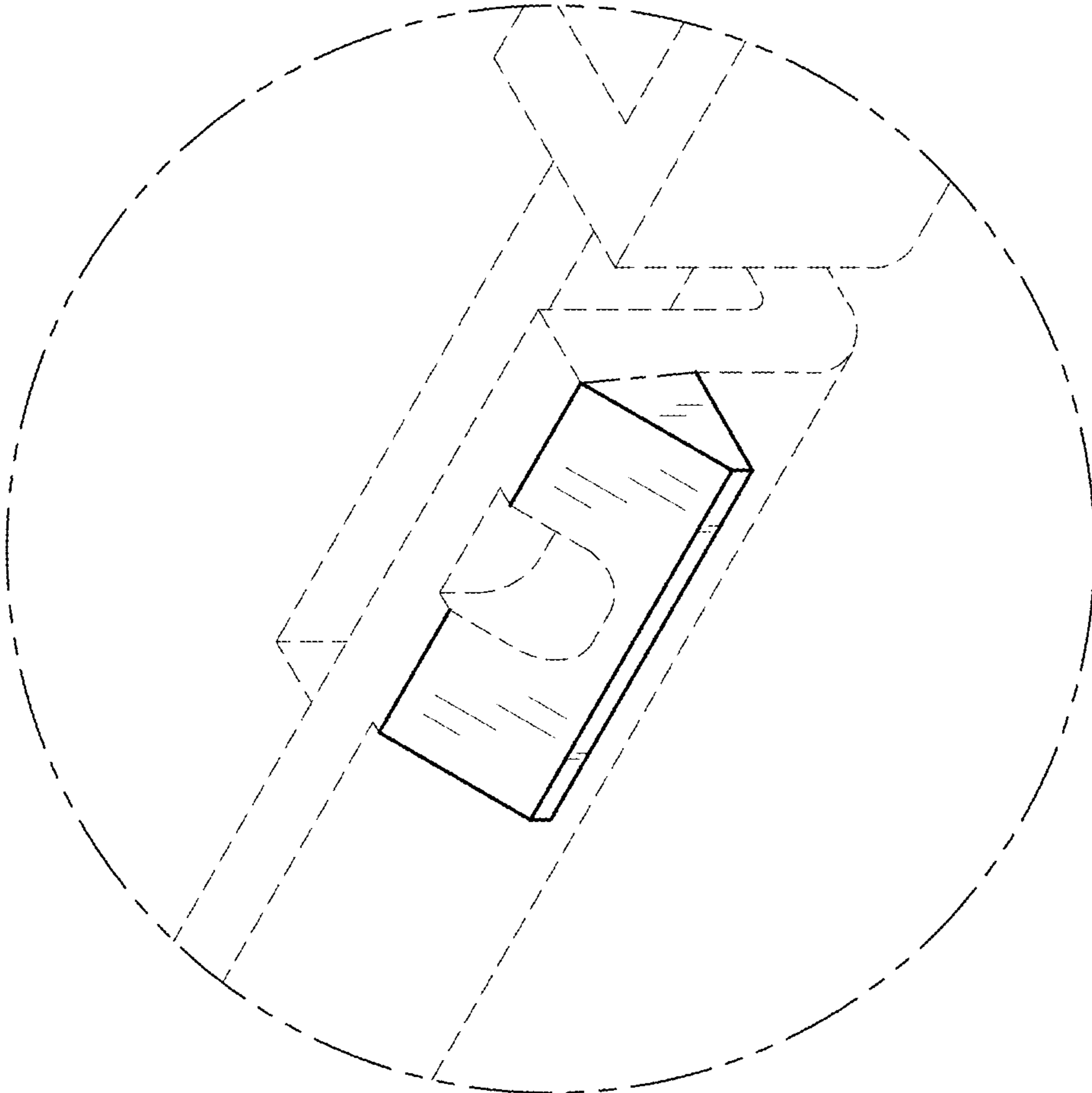

FIG. 15