



US00D906800S

(12) **United States Design Patent** (10) **Patent No.:** **US D906,800 S**
Ng (45) **Date of Patent:** **** Jan. 5, 2021**

(54) **FOOD CONTAINER**

(71) Applicant: **Tsing Kou Ng**, Castro Valley, CA (US)

(72) Inventor: **Tsing Kou Ng**, Castro Valley, CA (US)

(**) Term: **15 Years**

(21) Appl. No.: **29/687,139**

(22) Filed: **Apr. 10, 2019**

(51) **LOC (13) Cl.** **09-03**

(52) **U.S. Cl.**
USPC **D9/426**

(58) **Field of Classification Search**
USPC D7/400, 601, 608; D9/416, 417, 420,
D9/425-429, 430, 432, 761; 206/499,
206/501, 502, 821; 220/625, 656, 669,
220/670, 674; 229/123.1, 123.2, 125.33,
229/125.35, 400-407, 915, 939
CPC . B65D 1/26; B65D 1/40; B65D 5/243; B65D
81/3453; B65D 2581/34; B65D
2581/3404; B65D 2581/3456

See application file for complete search history.

(56) **References Cited**

U.S. PATENT DOCUMENTS

D236,691 S	9/1975	Haase	
D236,692 S	9/1975	Haase	
5,515,993 A	5/1996	McManus	
5,833,116 A *	11/1998	Guillin	B65D 43/0206 220/783
D536,992 S	2/2007	Garg et al.	
D540,666 S *	4/2007	Ramirez	D9/423
D586,623 S	2/2009	Dunn	
D601,014 S	9/2009	Petitjean	
D615,822 S	5/2010	Klein	
D625,180 S *	10/2010	Enriquez	D9/425
D627,221 S *	11/2010	Kovatch	D9/429
D640,548 S	6/2011	Lawrence et al.	
D664,841 S *	8/2012	Allers	D9/423

D668,537 S	10/2012	Sanfilippo	
D668,950 S	10/2012	Sanfilippo	
D675,517 S	2/2013	Garza	
D680,860 S	4/2013	Schulter et al.	
D681,446 S *	5/2013	Schulter	D9/426
D681,447 S	5/2013	Schulter et al.	
D682,674 S *	5/2013	Krueger	D9/426
D683,623 S	6/2013	Chen	
D686,064 S	7/2013	Garza	
D694,619 S	12/2013	Pham et al.	
D697,795 S	1/2014	Garza	
9,120,595 B2	9/2015	Chou	
9,132,942 B2	9/2015	Nikaein	
9,187,209 B1	11/2015	Hanna et al.	
D749,412 S	2/2016	Hu	
D752,430 S	3/2016	Stevenson et al.	
D756,770 S	5/2016	Snedden et al.	
D764,276 S	8/2016	Das et al.	
D778,115 S	2/2017	Strachan	
D778,155 S	2/2017	Strachan	
D778,722 S	2/2017	Strachan	

(Continued)

Primary Examiner — Janice Patyk

(74) Attorney, Agent, or Firm — Fulwider Patton LLP;
David J. Pitman

(57) **CLAIM**

The ornamental design for a food container, as shown and described.

DESCRIPTION

FIG. 1 is a top perspective view of a food container, showing my new design;
FIG. 2 is a bottom perspective view thereof;
FIG. 3 is a top view thereof;
FIG. 4 is a right side view thereof;
FIG. 5 is a bottom view thereof;
FIG. 6 is a left side view thereof;
FIG. 7 is a rear view thereof; and,
FIG. 8 is a front view thereof.

1 Claim, 5 Drawing Sheets

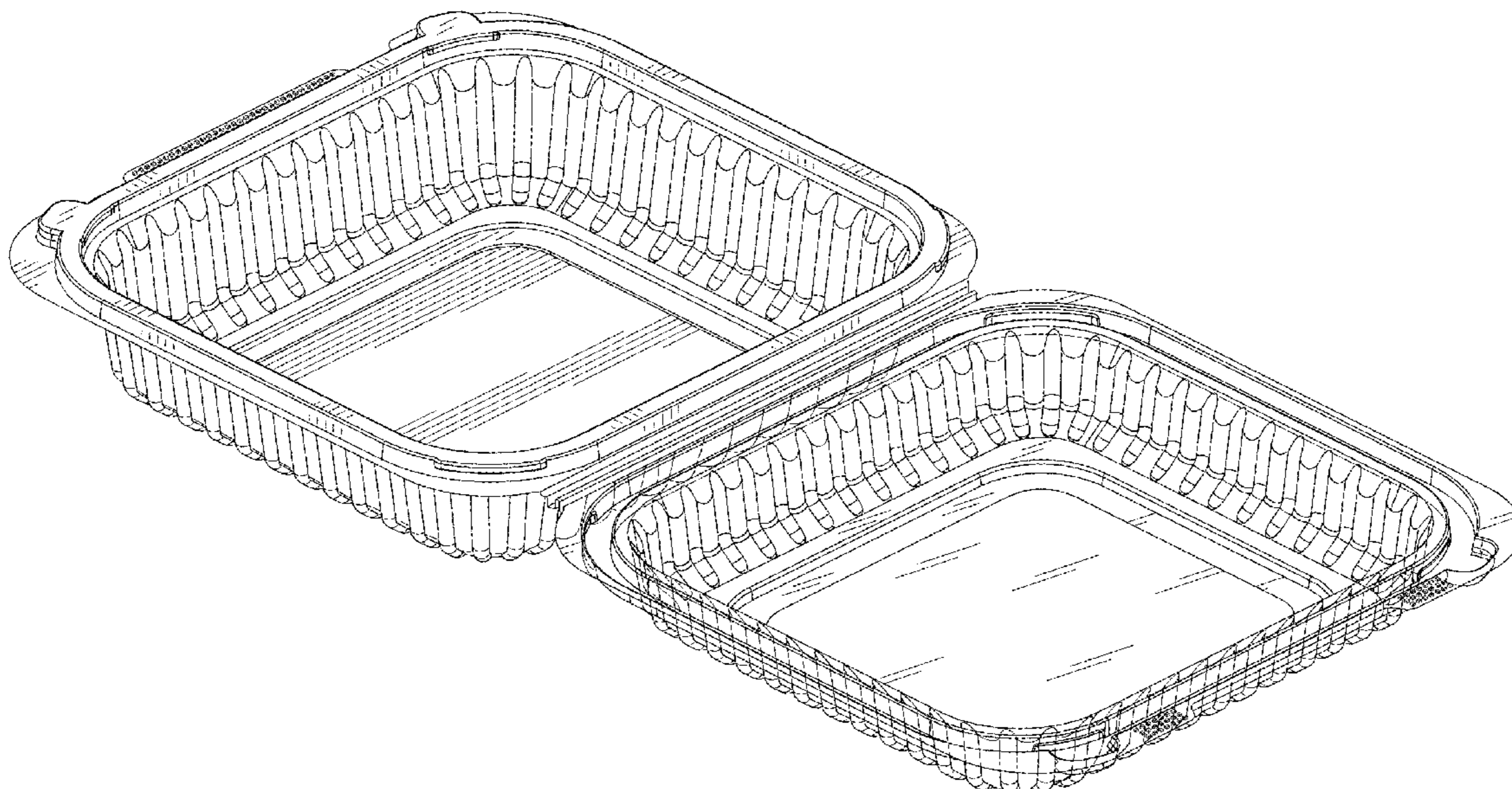

(56)

References Cited

U.S. PATENT DOCUMENTS

D781,698 S * 3/2017 Koroukian D9/420
D792,160 S 7/2017 Ng
D792,161 S 7/2017 Ng
D793,811 S 8/2017 Ng
D805,857 S * 12/2017 Mei D7/629
2005/0247709 A1 11/2005 Atkins et al.
2006/0081641 A1 4/2006 Habeger et al.
2007/0045317 A1 3/2007 Rosender et al.
2010/0072217 A1 3/2010 Parikh et al.
2010/0320210 A1* 12/2010 Cimmerer B65D 75/22
220/367.1
2011/0000929 A1 1/2011 Brown et al.
2011/0139785 A1 6/2011 Strange et al.
2012/0031921 A1 2/2012 Cadiente
2014/0284346 A1* 9/2014 McCumber B65D 43/162
220/792

* cited by examiner

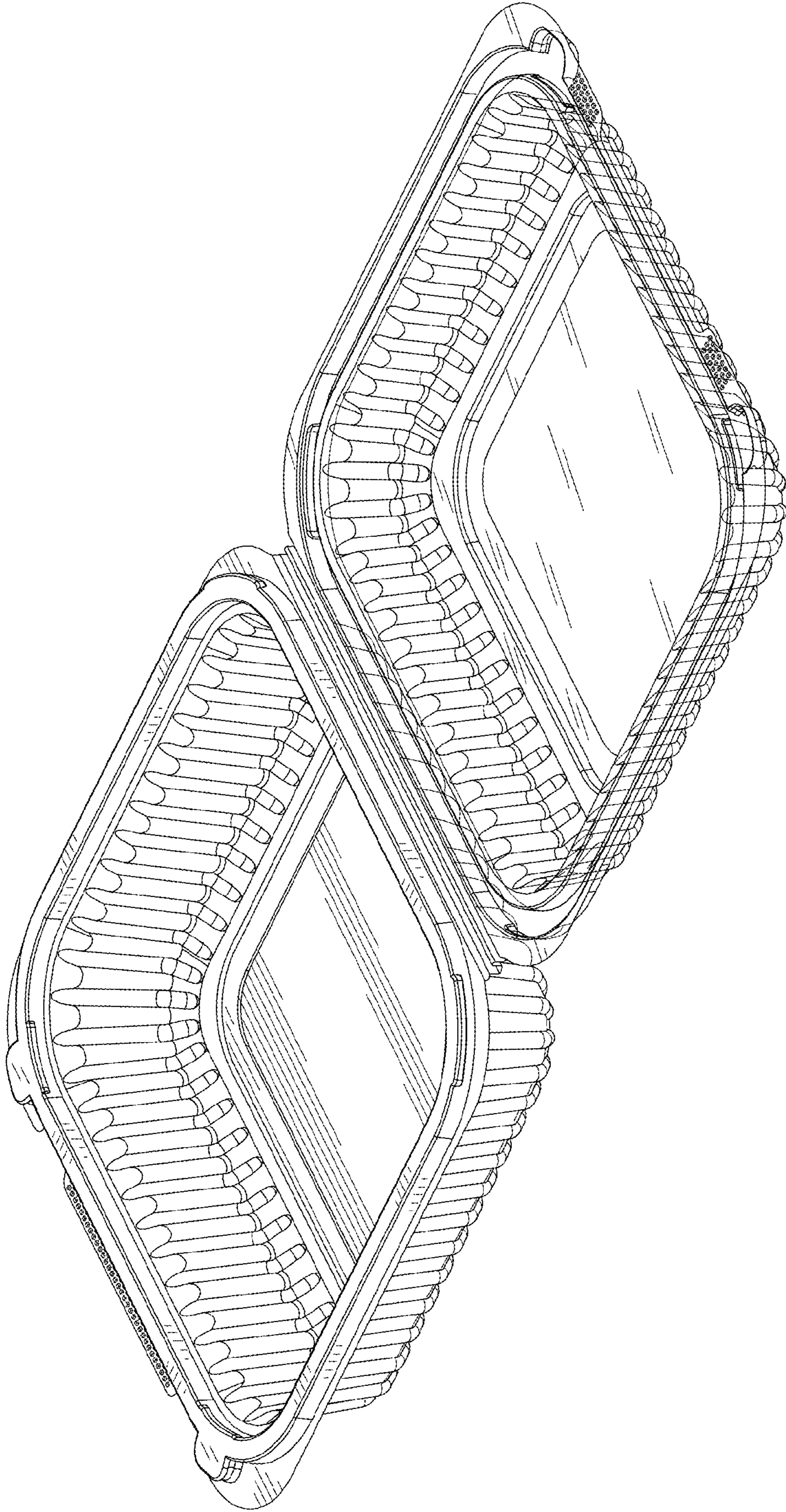

FIG. 1

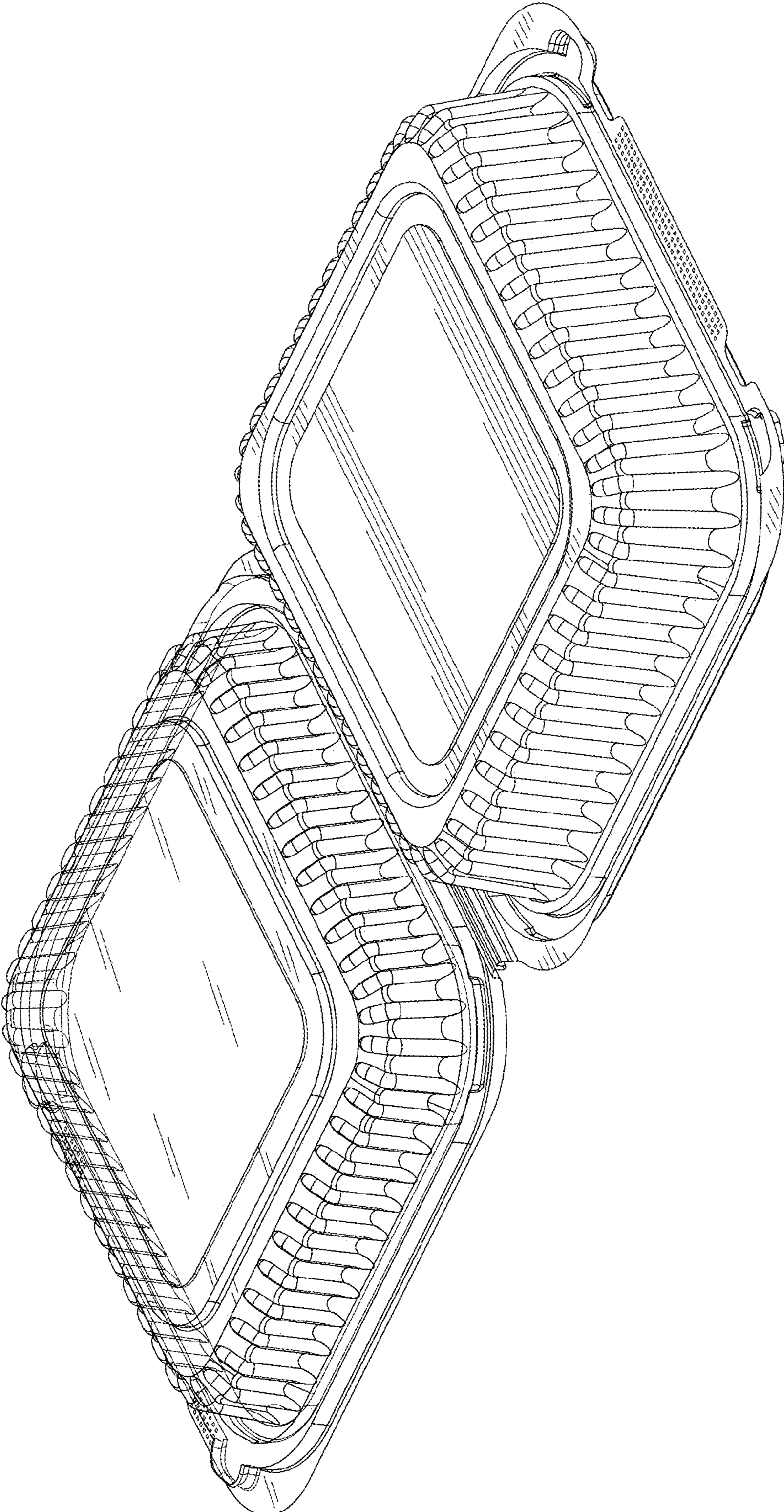

FIG. 2

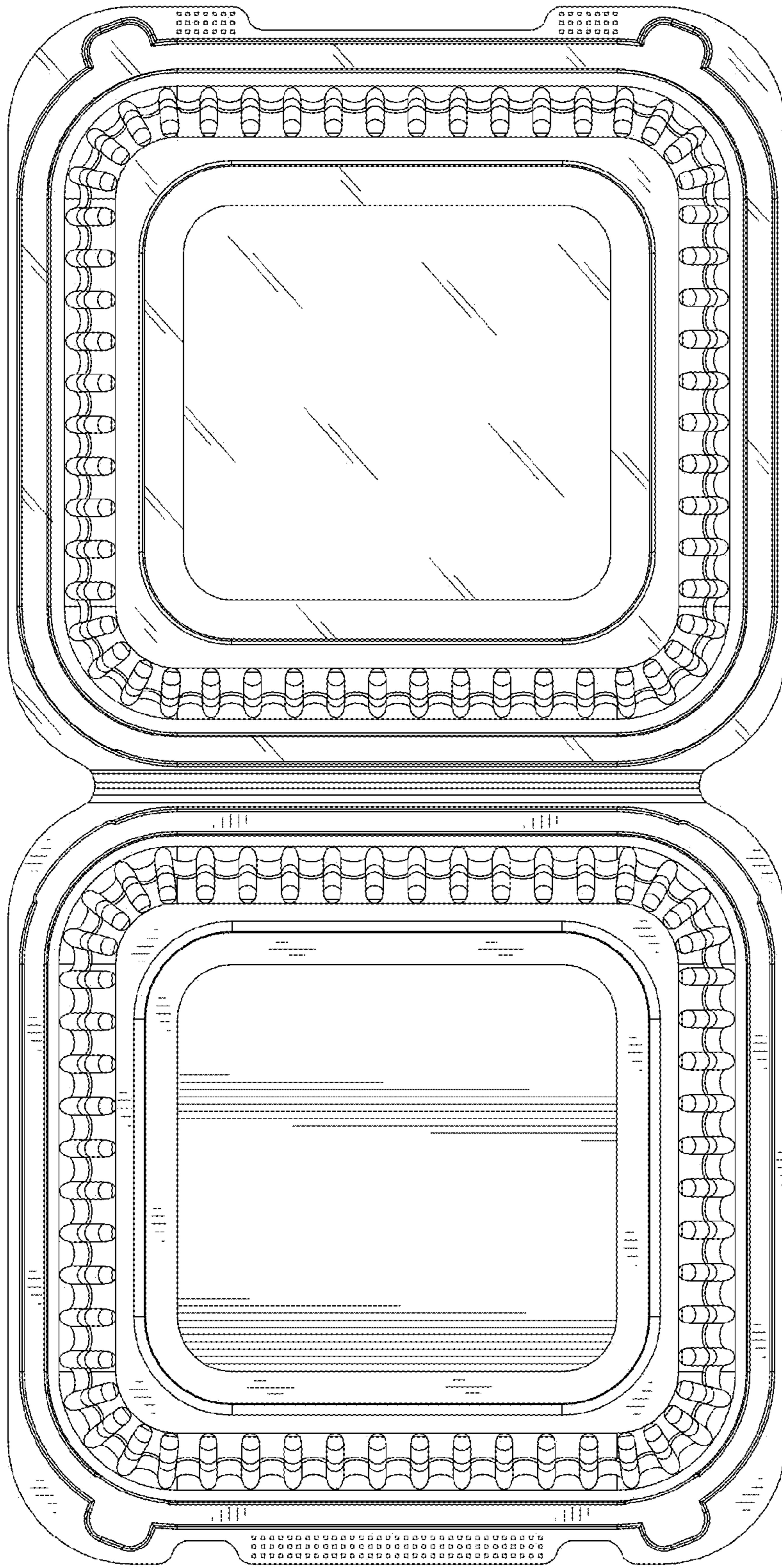

FIG. 3

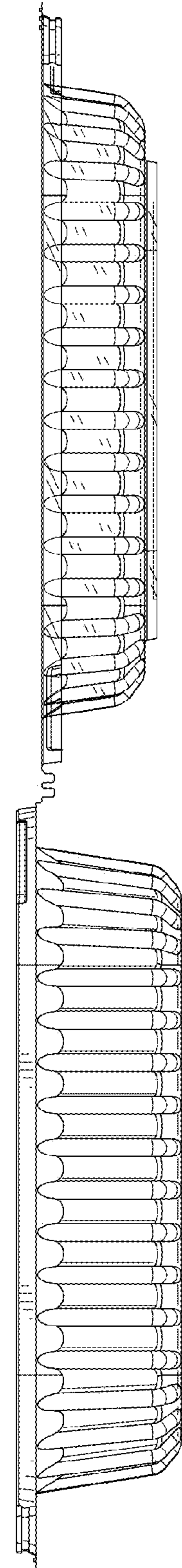

FIG. 4

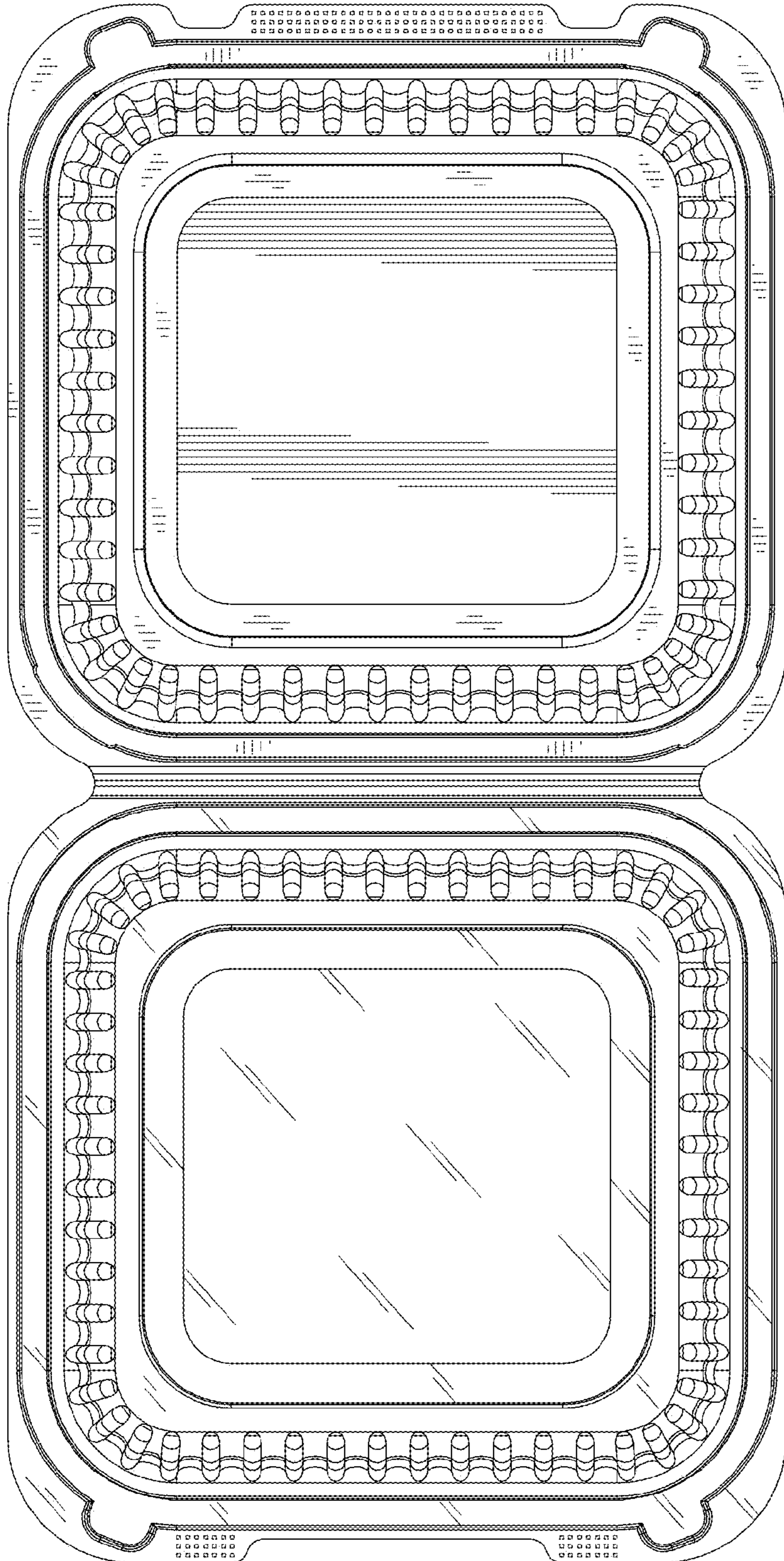

FIG. 5

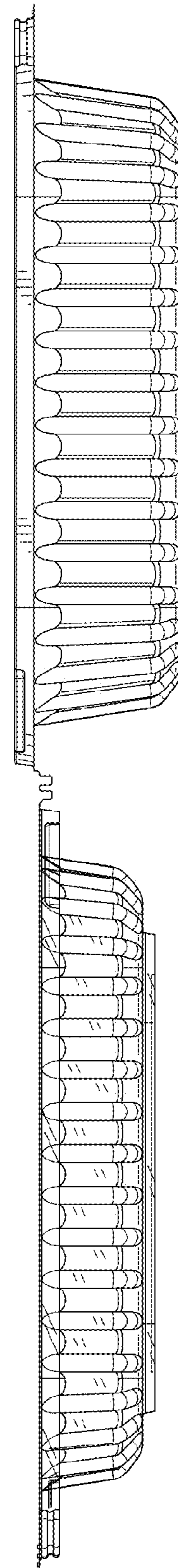

FIG. 6

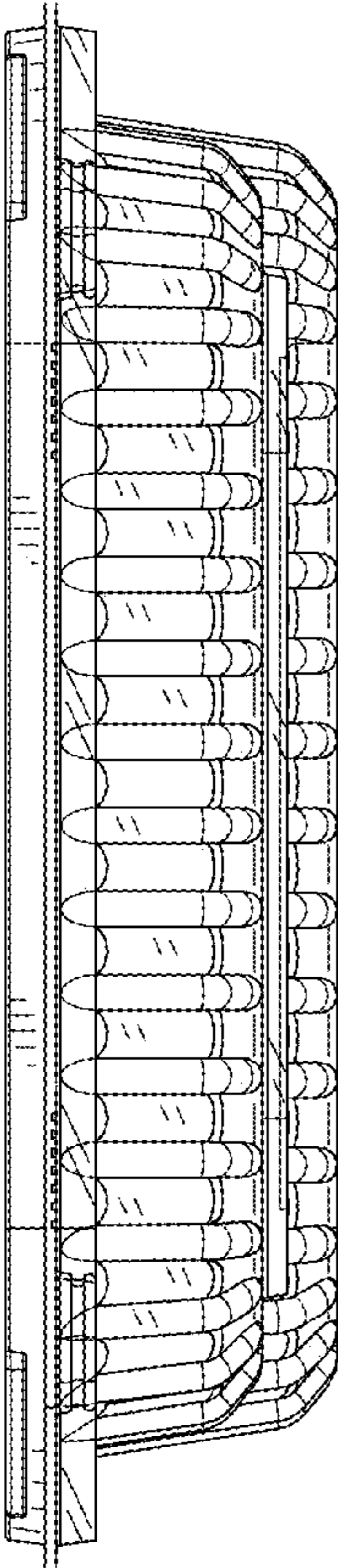

FIG. 7

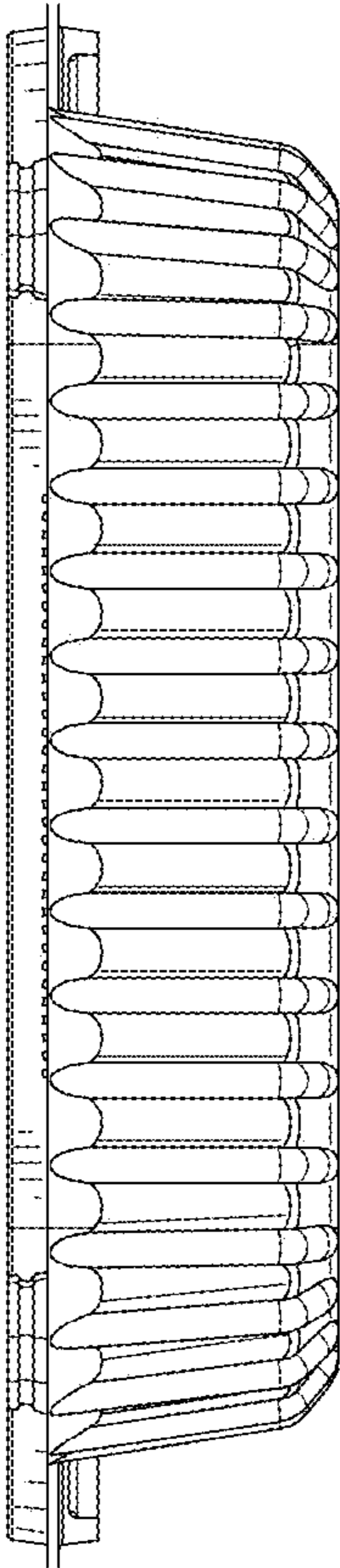

FIG. 8