



US00D906751S

(12) **United States Design Patent** (10) **Patent No.:** **US D906,751 S**  
**Li** (45) **Date of Patent:** **\*\* Jan. 5, 2021**

(54) **ELECTRIC MILK MAKING AND FOOD WARMING MACHINE**

(71) Applicant: **PURSEAT B.V., De Meern (NL)**

(72) Inventor: **Zheng Li, Vleuten (NL)**

(73) Assignee: **PURSEAT B.V., De Meern (NL)**

(\*\*) Term: **15 Years**

(21) Appl. No.: **35/508,018**

(22) Filed: **Mar. 19, 2019**

(80) **Hague Agreement Data**

Int. Filing Date: **Mar. 19, 2019**

Int. Reg. No.: **DM/204431**

Int. Reg. Date: **Mar. 19, 2019**

Int. Reg. Pub. Date: **Dec. 6, 2019**

(51) **LOC (13) Cl.** ..... **07-02**

(52) **U.S. Cl.**  
USPC ..... **D7/326**

(58) **Field of Classification Search**  
USPC ..... D7/323, 326, 339, 350.2, 412, 679, 693  
CPC .... A47J 36/2411; A47J 36/2433; A47J 36/24;  
A47J 36/2416; A47J 36/2422; A47J  
36/2427; A47J 36/2444; A21C 1/02;  
A23N 1/00; A61B 5/4809  
See application file for complete search history.

(56) **References Cited**

**U.S. PATENT DOCUMENTS**

D176,310 S \* 12/1955 Conlin et al. .... D7/326  
3,245,400 A \* 4/1966 Bowman ..... A47J 39/02  
126/261

D236,910 S \* 9/1975 Oyler ..... A47J 39/02  
D7/347  
D296,239 S \* 6/1988 David ..... D24/217  
D341,515 S \* 11/1993 Hamada ..... D7/350.2  
D346,303 S \* 4/1994 Kaneko ..... D7/350.2  
D354,195 S \* 1/1995 Kaneko ..... D7/350.2  
D375,432 S \* 11/1996 Hamada ..... D7/350.2  
D786,027 S \* 5/2017 Kim ..... D7/665  
D844,373 S \* 4/2019 DeLeo ..... D7/386  
D864,655 S \* 10/2019 Brook ..... D7/386  
D897,752 S \* 10/2020 Zhang ..... D7/326

\* cited by examiner

*Primary Examiner* — Robert M. Spear  
(74) *Attorney, Agent, or Firm* — SZDC Law P.C.

(57) **CLAIM**

The ornamental design for a electric milk making and food warming machine, as shown and described.

**DESCRIPTION**

- 1. Electric milk making and food warming machine
- 1.1 : Perspective
- 1.2 : Perspective
- 1.3 : Front
- 1.4 : Right
- 1.5 : Back
- 1.6 : Top
- 1.7 : Left
- 1.8 : Bottom

**1 Claim, 8 Drawing Sheets**

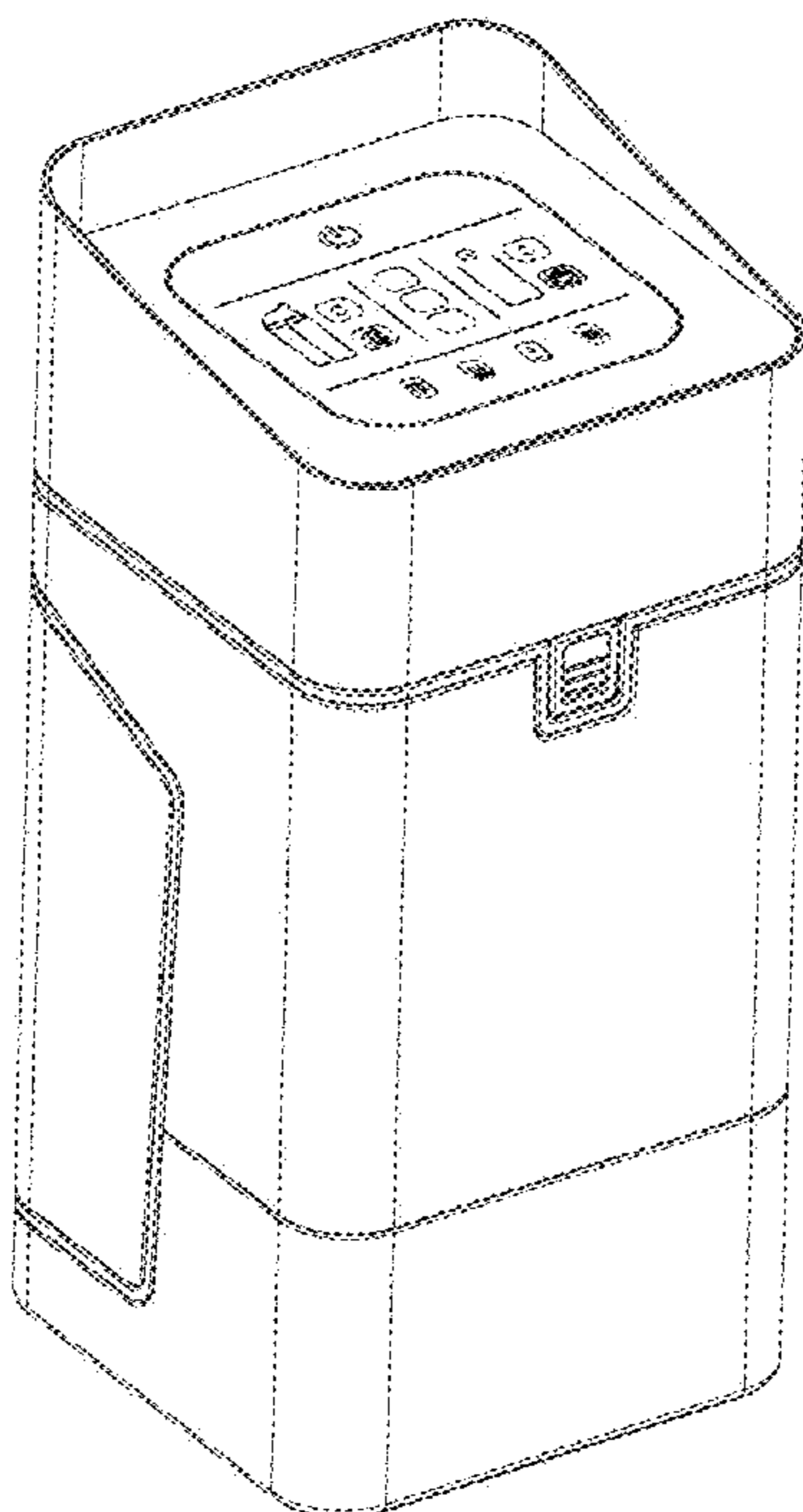

1.1

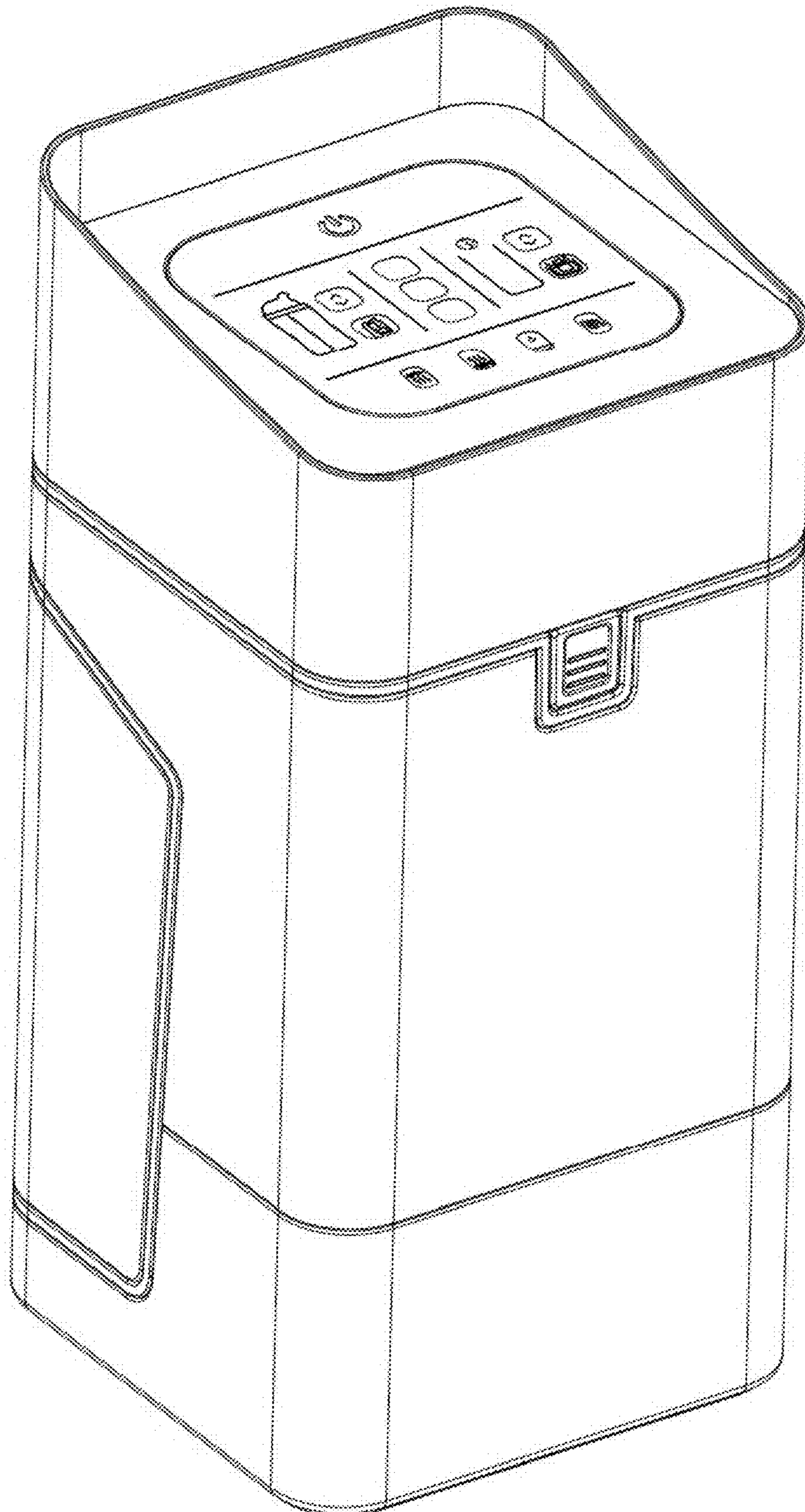



1.2

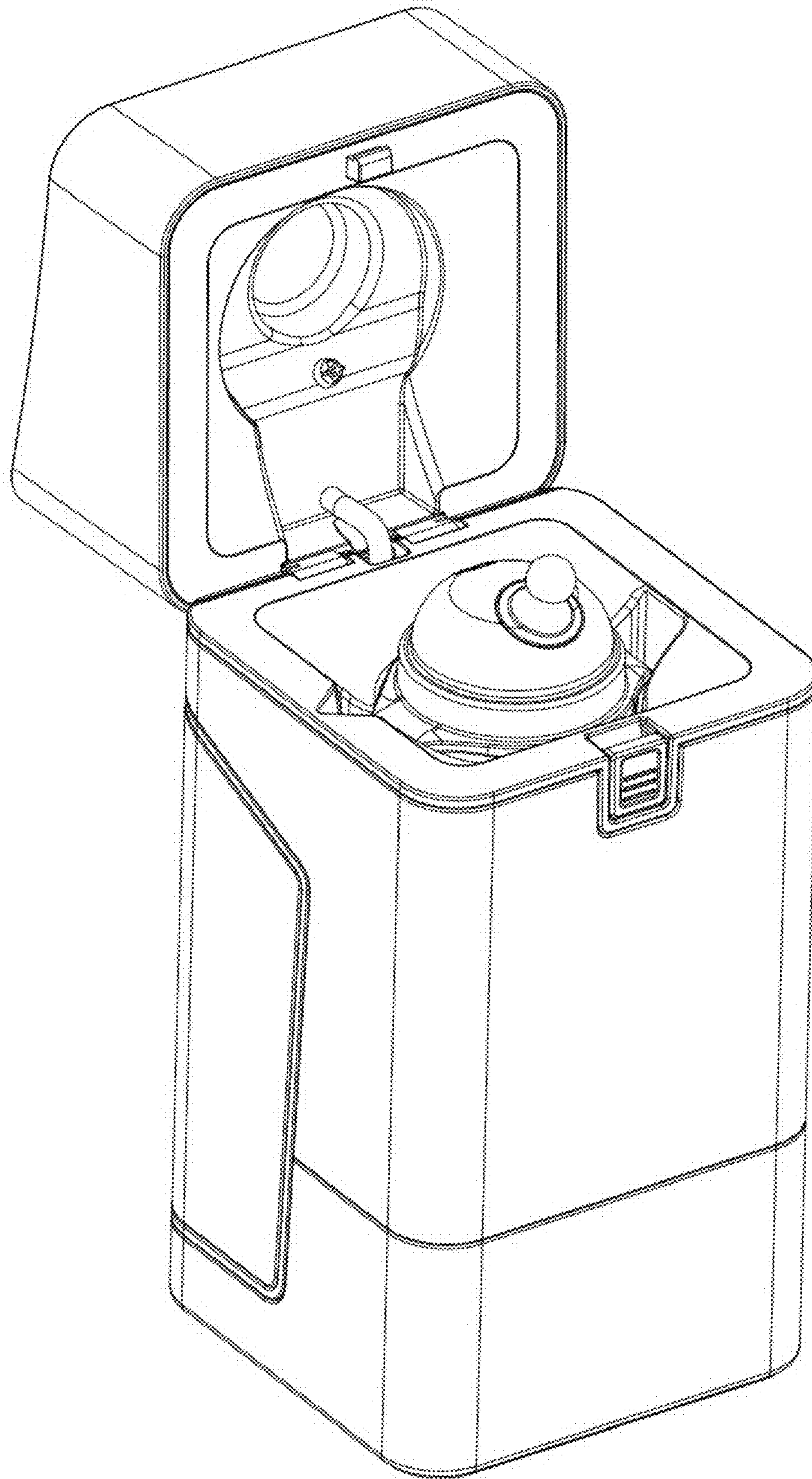

1.3

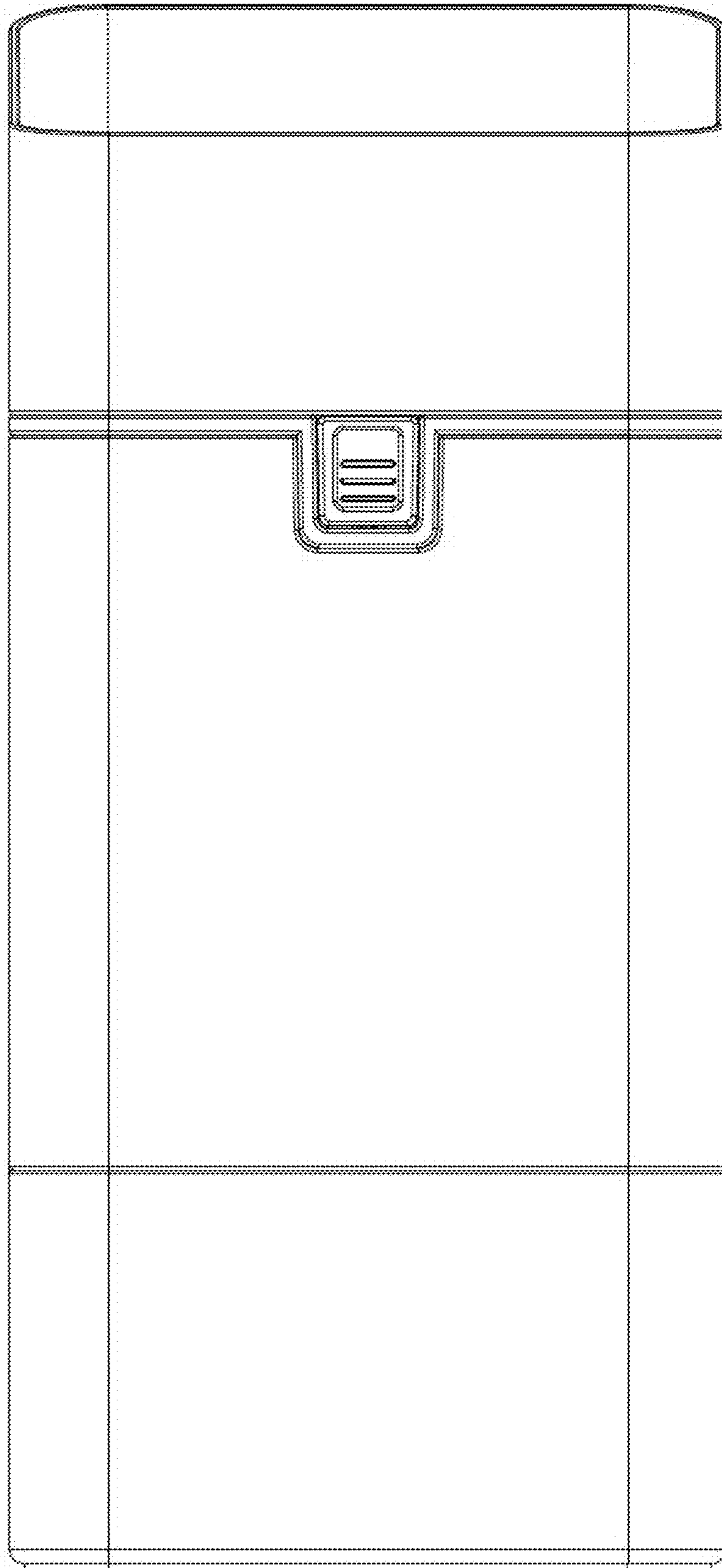

1.4

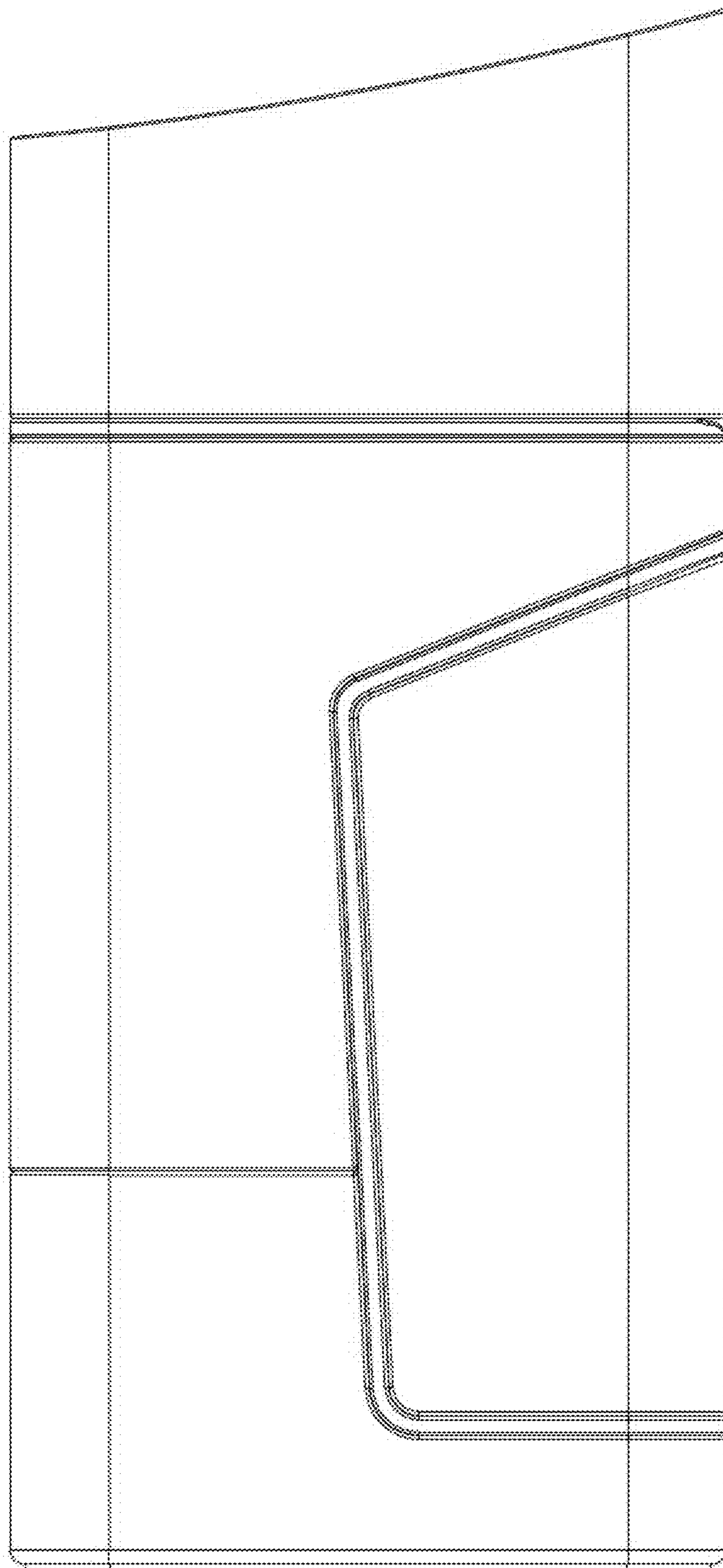

1.5

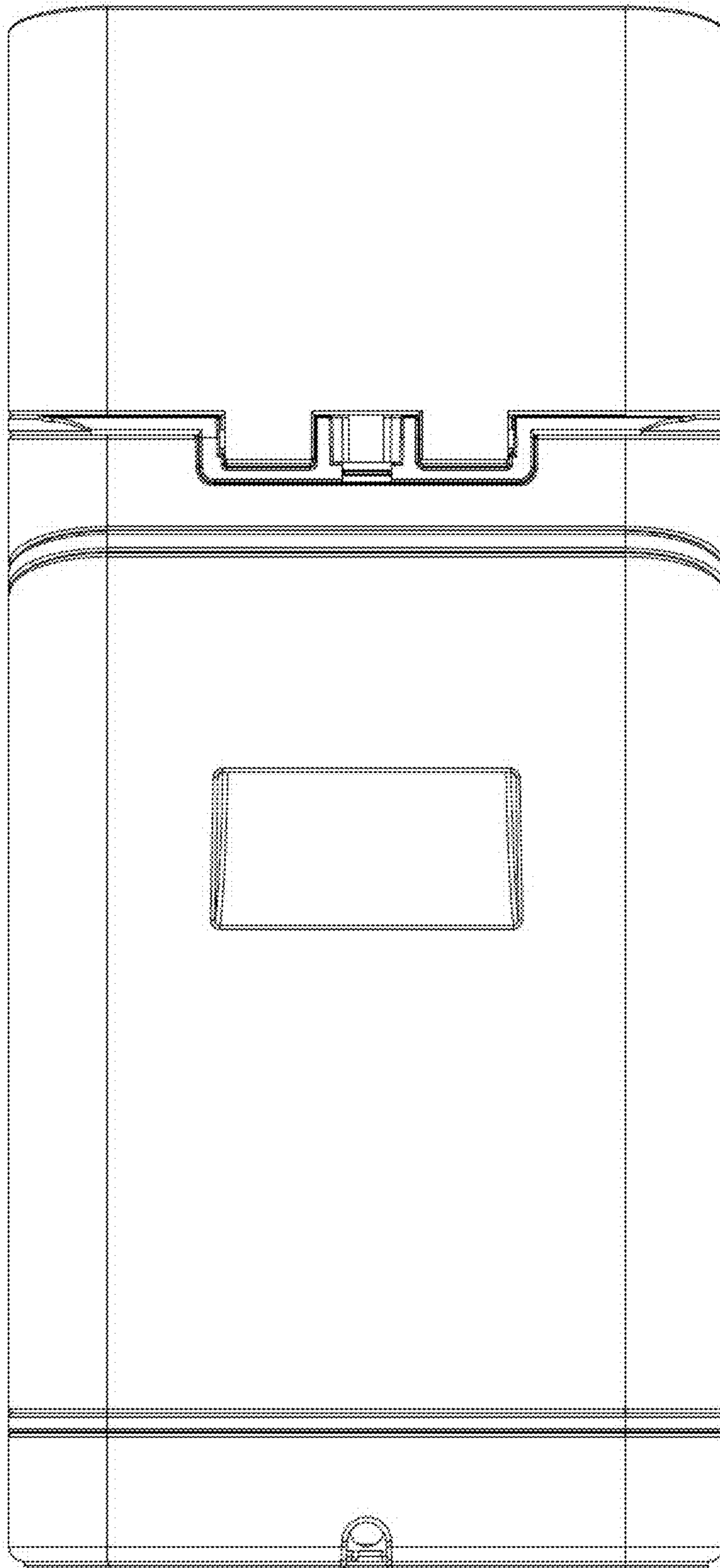



# 1.6

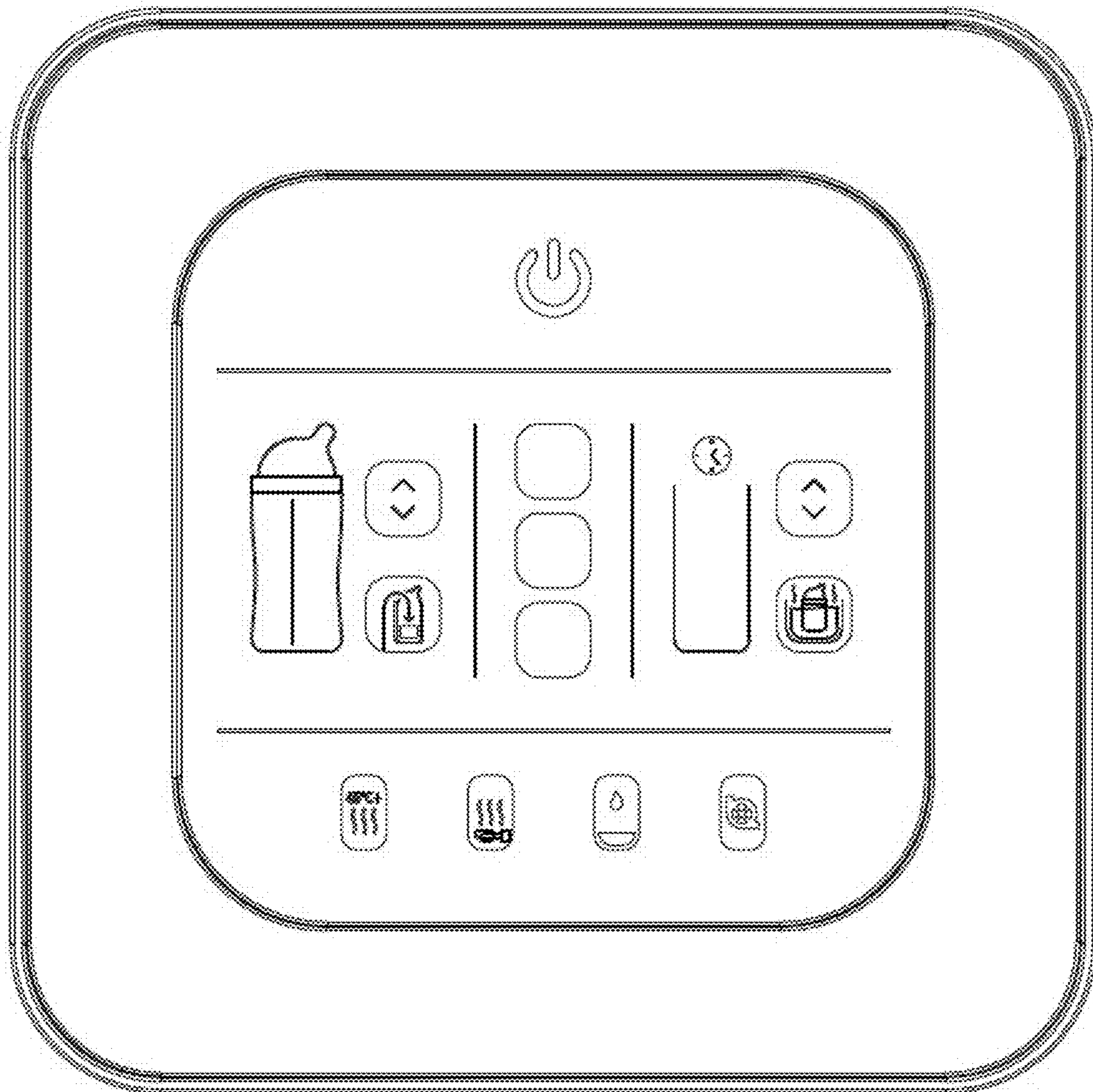

1.7

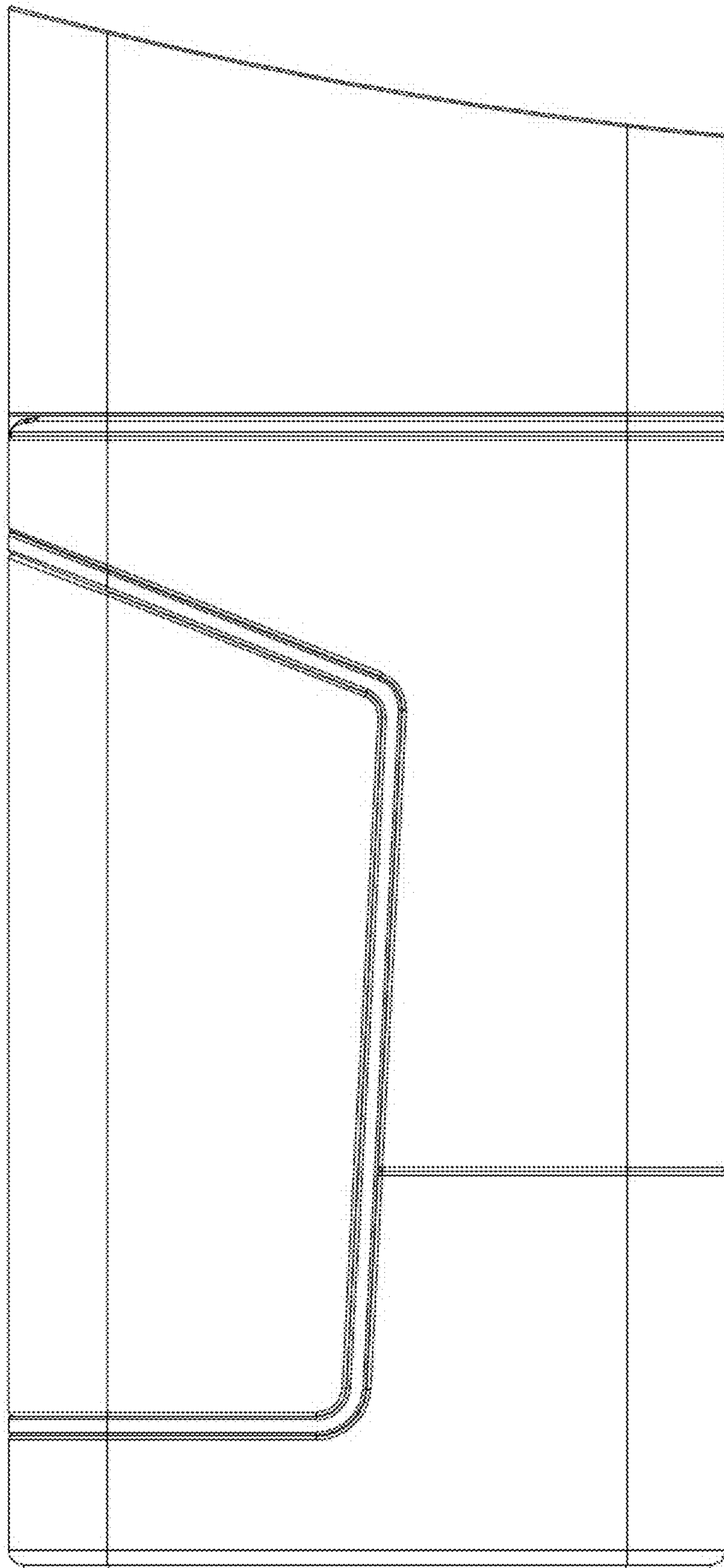



1.8

