



US00D906748S

(12) **United States Design Patent**
Wang

(10) **Patent No.:** **US D906,748 S**

(45) **Date of Patent:** **** Jan. 5, 2021**

(54) **CHAIR**

(71) Applicant: **Henglin Home Furnishings Co., Ltd.,**
Zhejiang (CN)

(72) Inventor: **Jianglin Wang,** Zhejiang (CN)

(73) Assignee: **Henglin Home Furnishings Co., Ltd.,**
Zhejiang (CN)

(**) Term: **15 Years**

(21) Appl. No.: **29/708,202**

(22) Filed: **Oct. 4, 2019**

(51) **LOC (13) Cl.** **06-01**

(52) **U.S. Cl.**
USPC **D6/716**

(58) **Field of Classification Search**
USPC D6/334, 365, 366, 369, 375, 379, 380,
D6/716, 716.4
CPC A47C 3/12; A47C 3/18; A47C 3/20; A47C
5/02; A47C 5/12; A47C 7/24; A47C 7/36;
A47C 7/46
See application file for complete search history.

(56) **References Cited**

U.S. PATENT DOCUMENTS

D410,799 S * 6/1999 Meda D6/366
D516,828 S * 3/2006 Tsai D6/366
D696,886 S * 1/2014 Nakamura D6/716.4
D701,068 S * 3/2014 Usumoto D6/716

D816,362 S * 5/2018 Su D6/366
D870,479 S * 12/2019 Deevers D6/366
D879,491 S * 3/2020 Wang D6/366
D880,182 S * 4/2020 Wang D6/366
D896,539 S * 9/2020 Kumazawa D6/364
2014/0265493 A1* 9/2014 Machael A47C 7/44
297/285
2015/0320220 A1* 11/2015 Eberlein A47C 7/40
297/452.18
2017/0354260 A1* 12/2017 Aldrich A47C 7/462
2019/0298069 A1* 10/2019 Masunaga A47C 7/462

* cited by examiner

Primary Examiner — R. Johnson

(74) *Attorney, Agent, or Firm* — JCIP Global Inc.

(57) **CLAIM**

The ornamental design for a chair, as shown and described.

DESCRIPTION

FIG. 1 is a perspective view of a chair showing my new design;

FIG. 2 is a front view thereof;

FIG. 3 is a rear view thereof;

FIG. 4 is a left side view thereof;

FIG. 5 is a right side view thereof; and,

FIG. 6 is a top view thereof.

A bottom view thereof is omitted since it does not contain ornamental features. The heavy broken line showing of stitch lines in FIGS. 1-6 forms portions of the claimed design, while the light broken line showing of portions of the chair in FIGS. 1-6 forms no part of the claimed design.

1 Claim, 6 Drawing Sheets

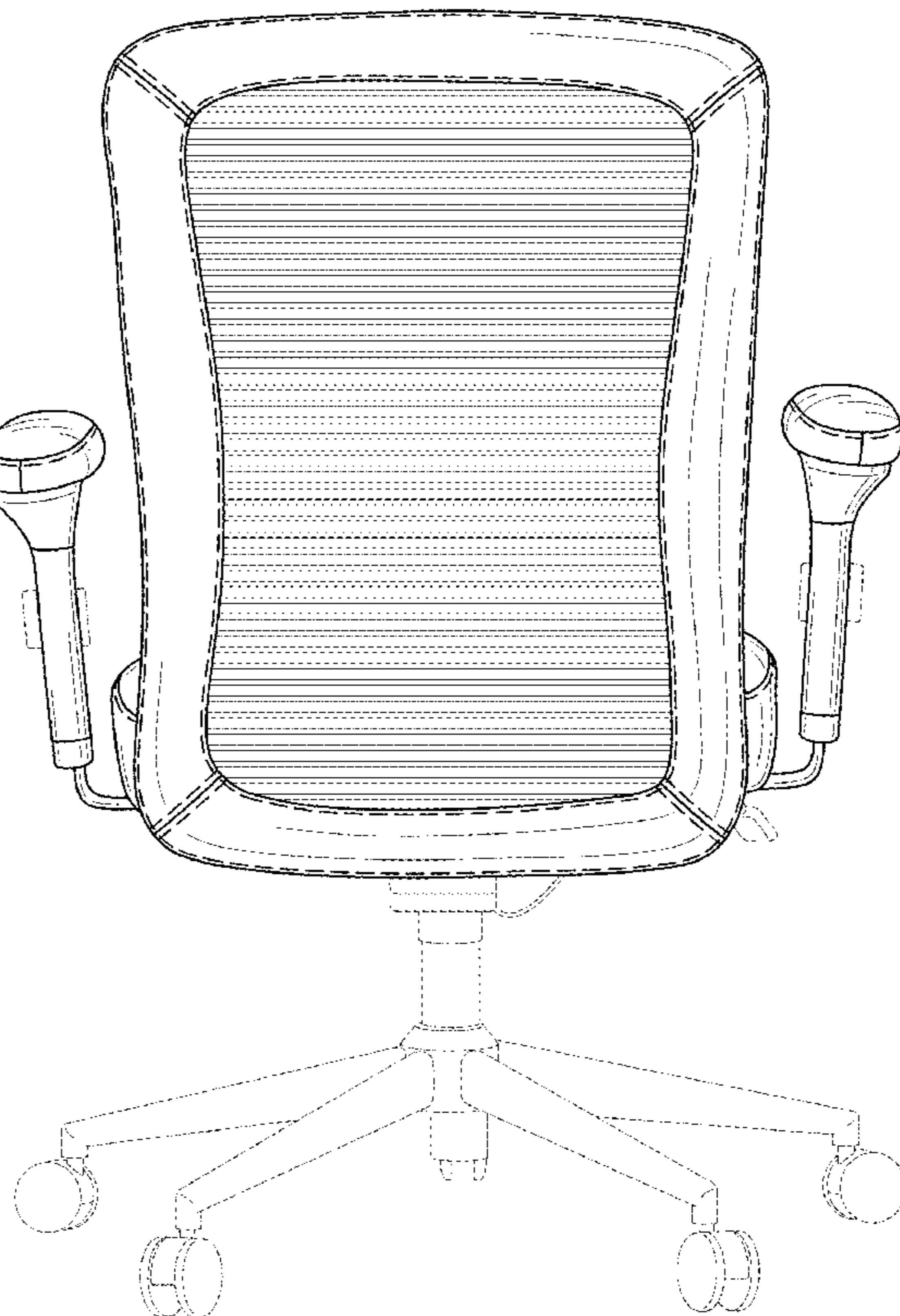
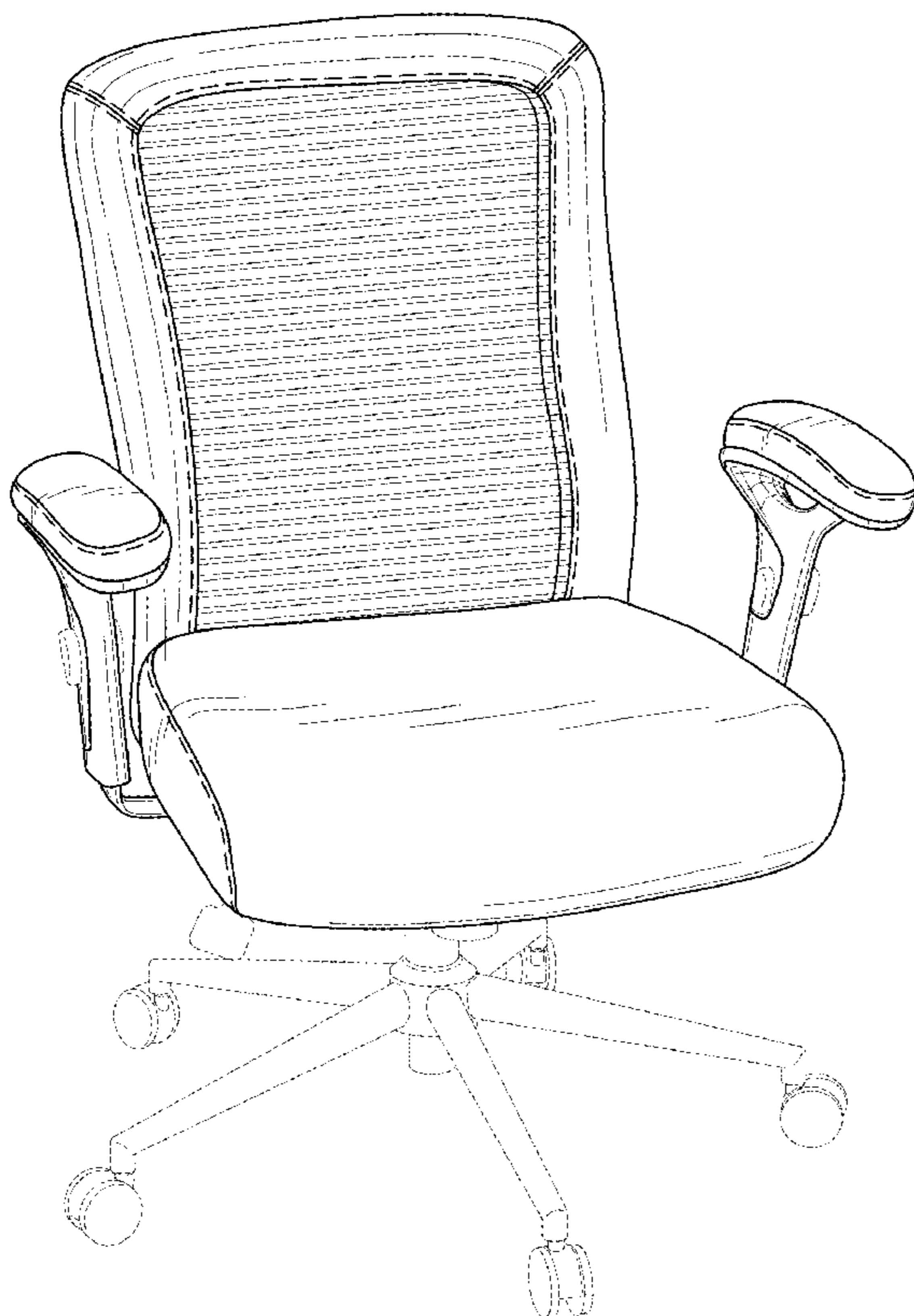

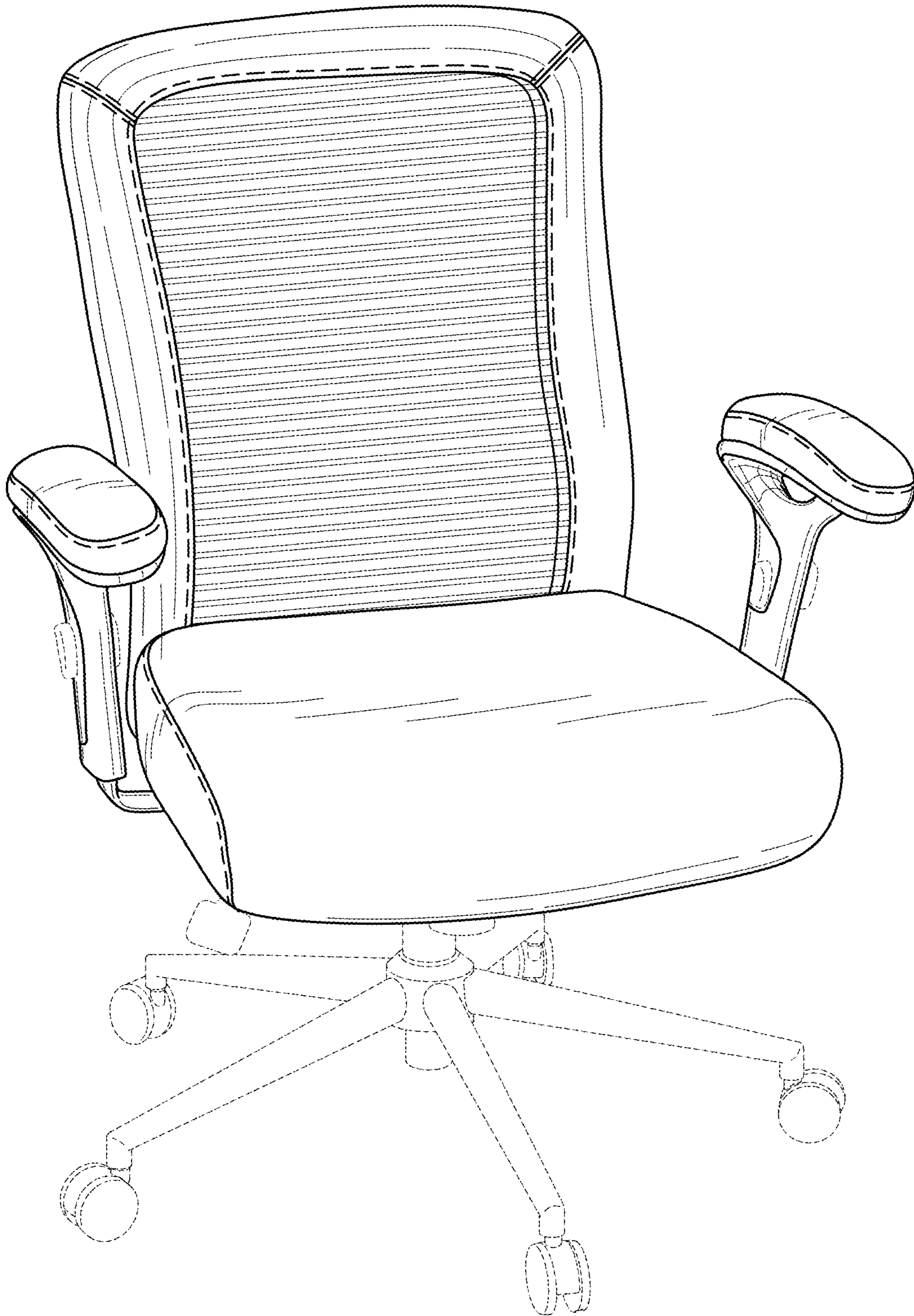

FIG. 1

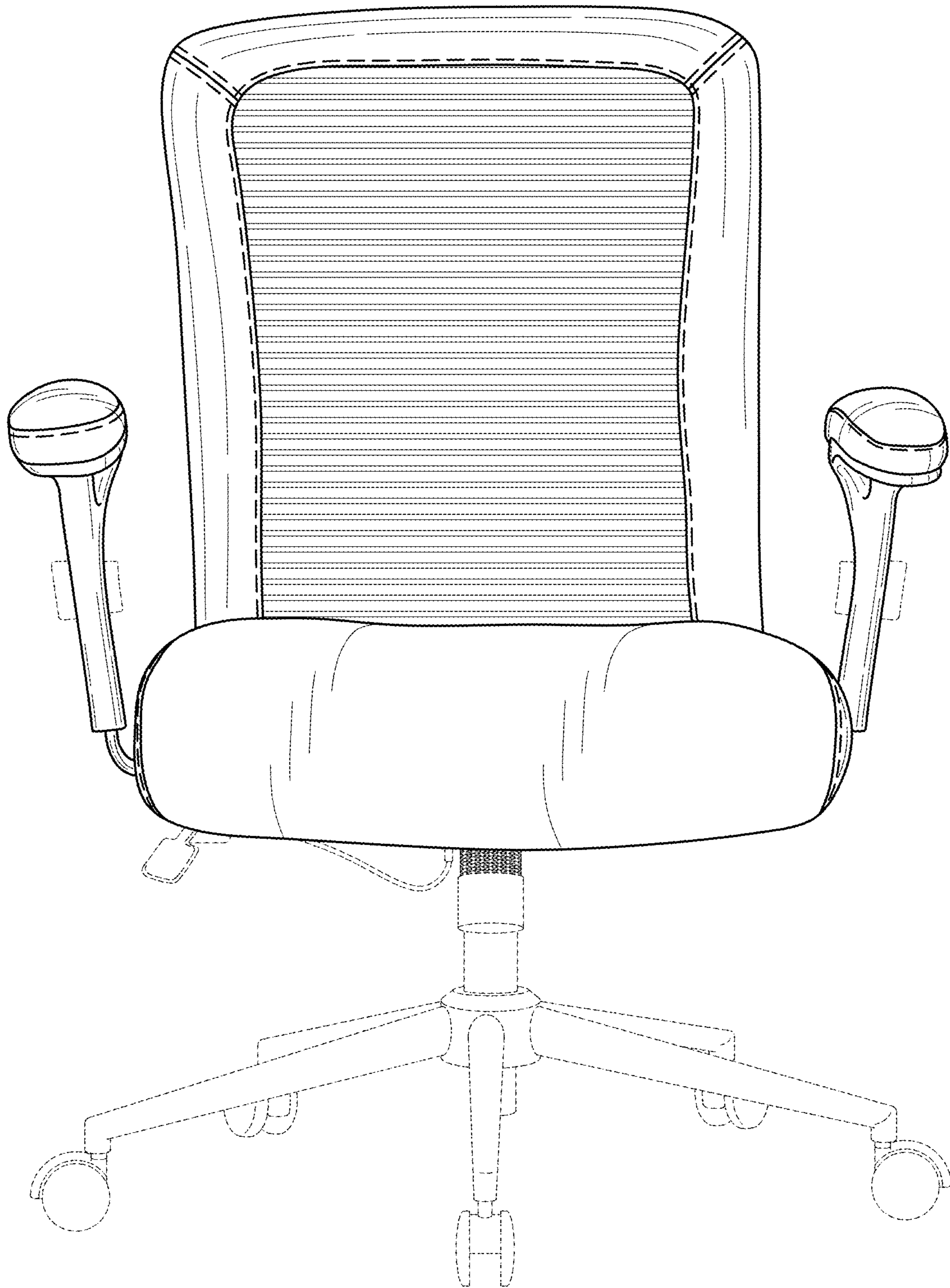

FIG. 2

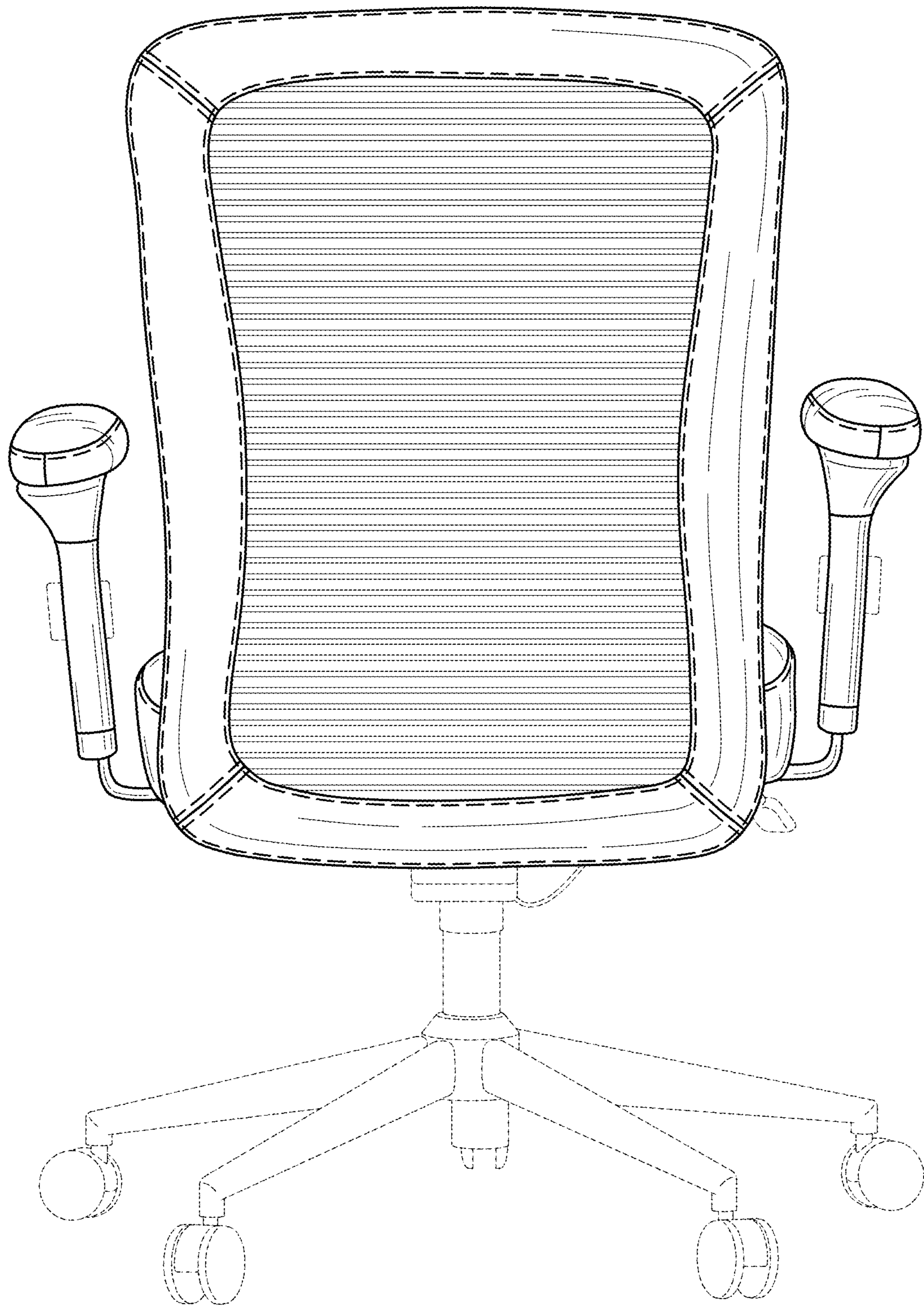

FIG. 3

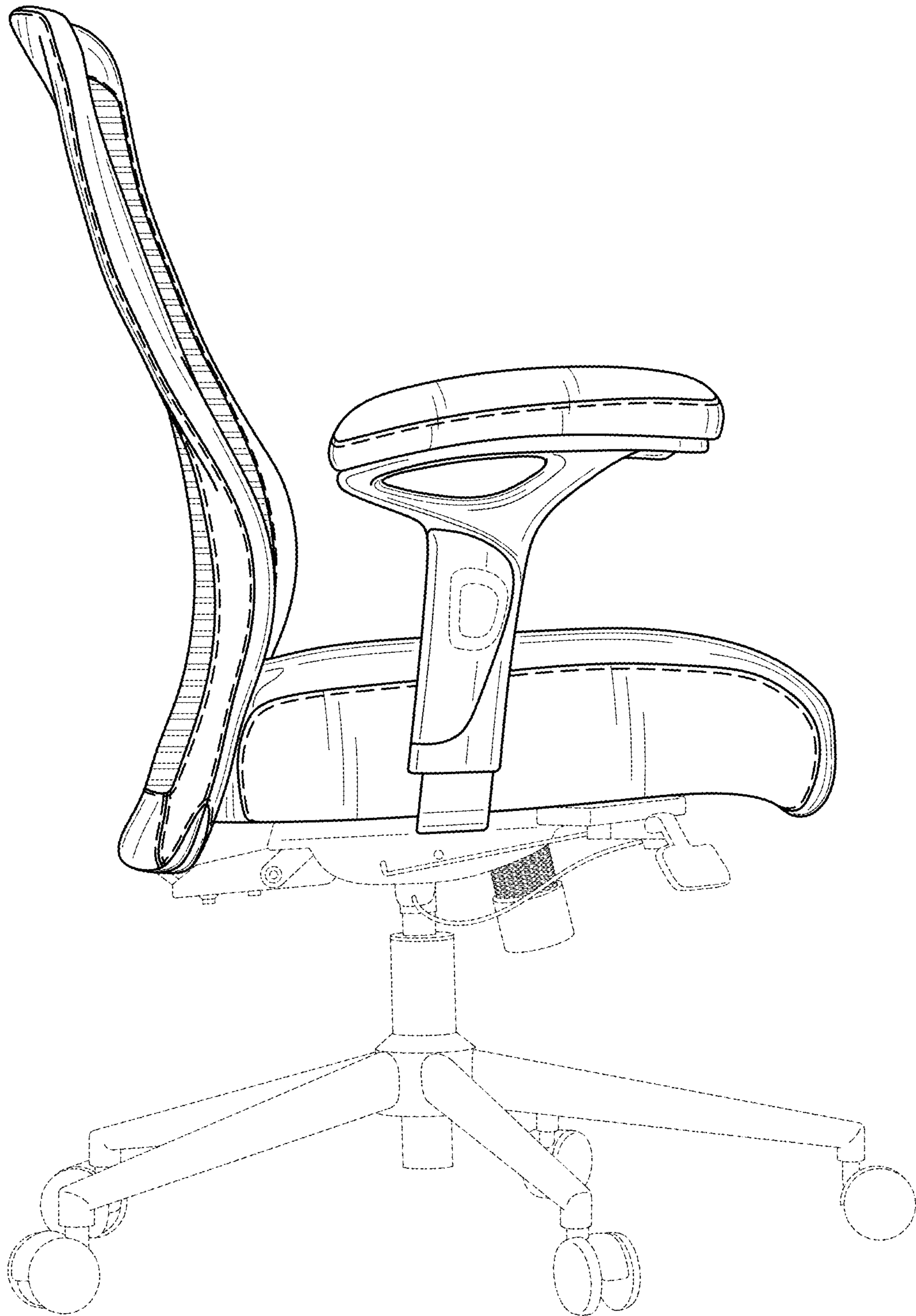

FIG. 4

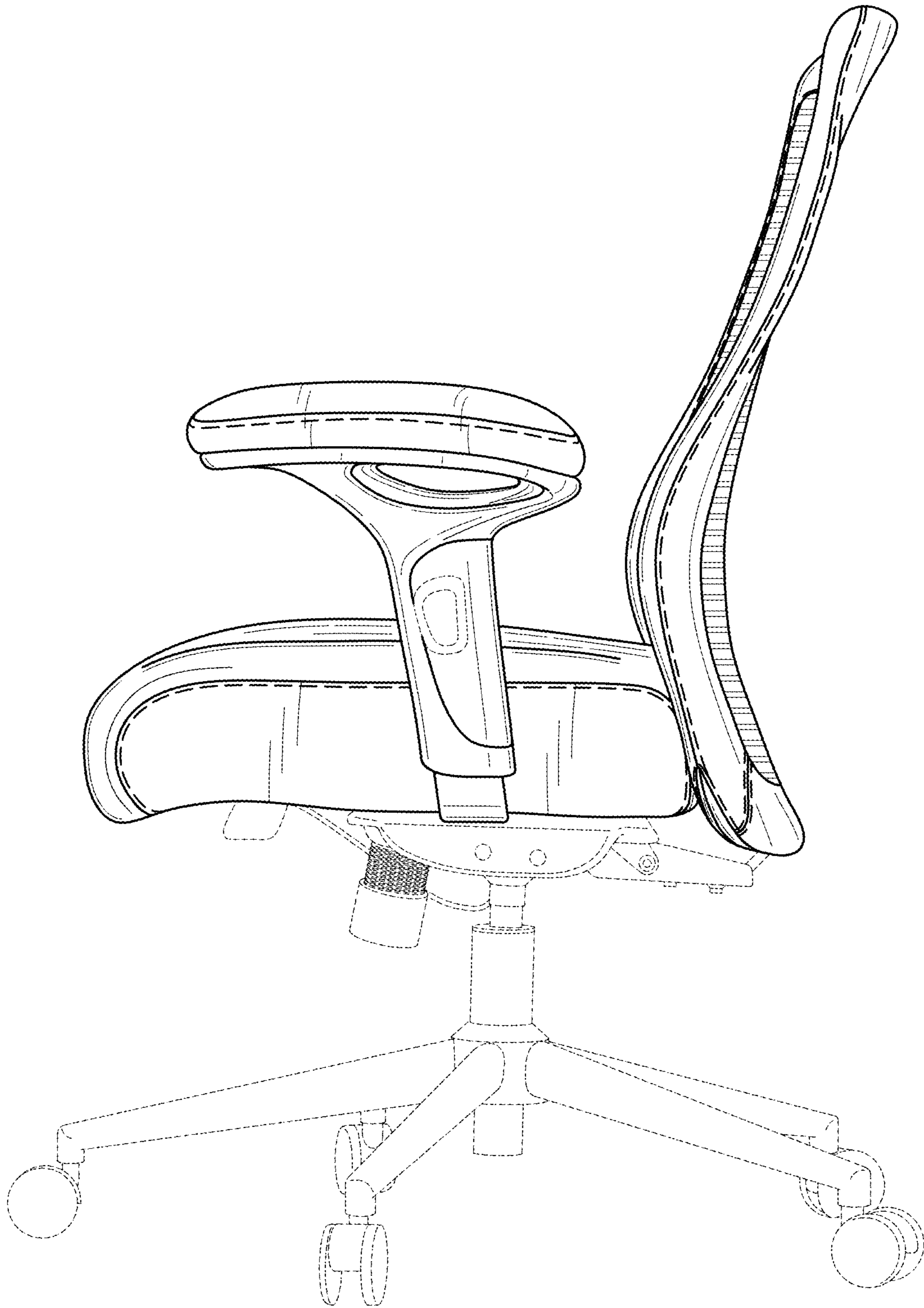

FIG. 5

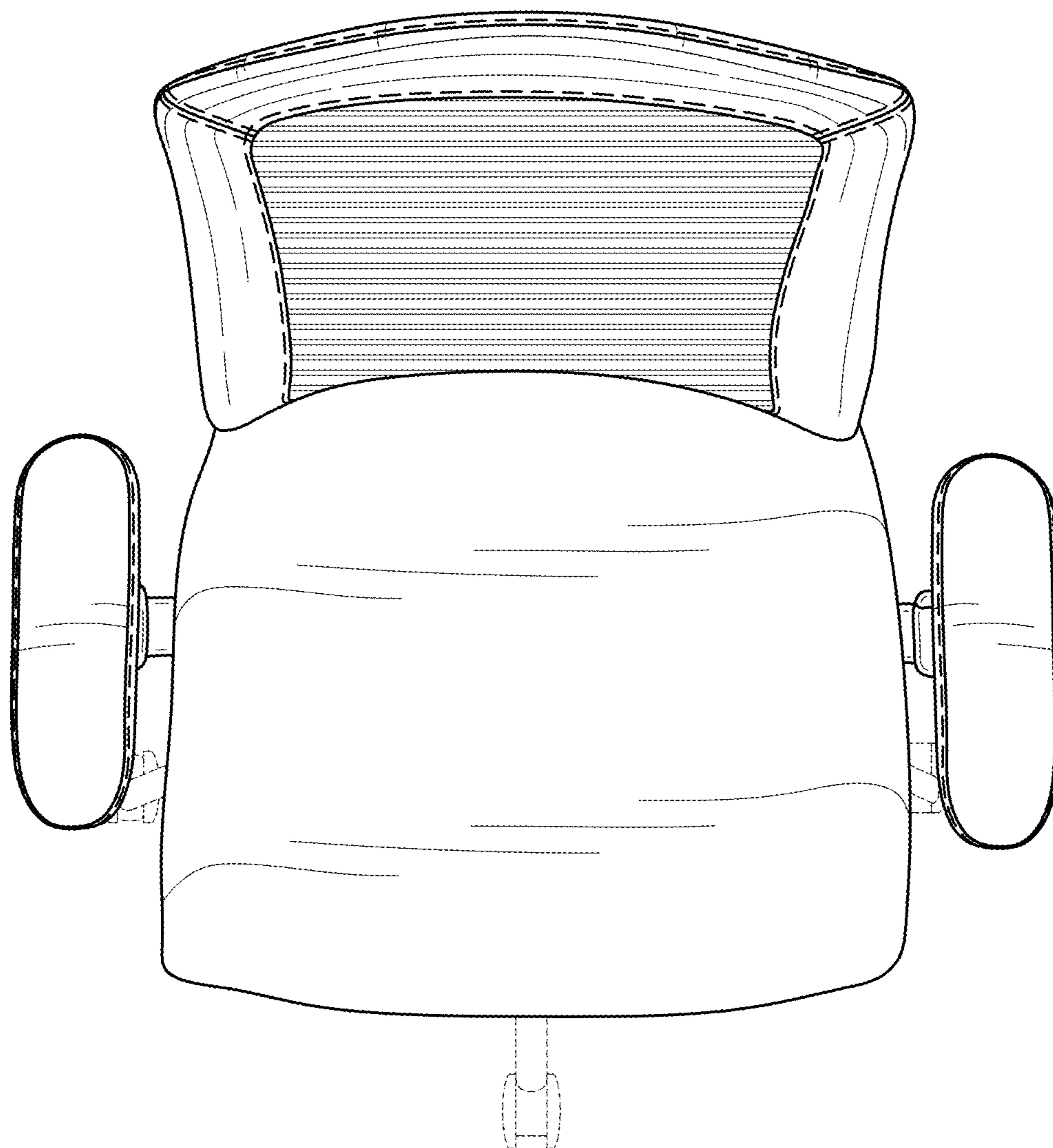

FIG. 6