



US00D906663S

(12) **United States Design Patent**
Busch

(10) **Patent No.:** **US D906,663 S**

(45) **Date of Patent:** **** Jan. 5, 2021**

(54) **COMPONENT OF A POCKET KEY ORGANIZER**

(71) Applicant: **BladeKey LLC**, Tempe, AZ (US)

(72) Inventor: **James David Busch**, Tempe, AZ (US)

(73) Assignee: **BladeKey LLC**, Tempe, AZ (US)

(**) Term: **15 Years**

(21) Appl. No.: **29/672,889**

(22) Filed: **Dec. 10, 2018**

Related U.S. Application Data

(63) Continuation of application No. 29/567,703, filed on Jun. 10, 2016, now Pat. No. Des. 839,588, which is a continuation of application No. 29/522,662, filed on Apr. 1, 2015, now Pat. No. Des. 759,755, which is a continuation of application No. 29/502,498, filed on Sep. 17, 2014, now Pat. No. Des. 730,446, which is a continuation-in-part of application No. 29/457,348, filed on Jun. 9, 2013, now Pat. No. Des. 714,537, which is a continuation-in-part of application No. 29/438,466, filed on Nov. 30, 2012, now Pat. No. Des. 683,951, which is a continuation of application No. 29/406,366, filed on Nov. 13, 2011, now Pat. No. Des. 674,590.

(51) **LOC (13) Cl.** **03-01**

(52) **U.S. Cl.**
USPC **D3/207**

(58) **Field of Classification Search**
USPC D3/207, 208, 209, 210, 211, 212; D8/33, D8/34, 38
CPC .. A44B 15/00; Y10T 70/8676; Y10T 24/1379
See application file for complete search history.

(56) **References Cited**

U.S. PATENT DOCUMENTS

D3,942 S 3/1870 Elwell
1,728,128 A 9/1929 Kodama
1,885,957 A 11/1932 Singleton

1,909,735 A 5/1933 Vavrosky
1,922,755 A 8/1933 Buxton
D97,570 S * 11/1935 Trolen D3/210
2,038,070 A 4/1936 Welch
2,228,726 A 1/1941 Loesch
2,245,381 A * 6/1941 Biggs A45C 11/324
70/456 R
D133,144 S 7/1942 Stuble
2,306,970 A 12/1942 MacPherson et al.
2,344,581 A 3/1944 Ziegeweid
D156,677 S 5/1948 Smith
2,482,623 A 9/1949 Kaminer
2,514,940 A 7/1950 Doss et al.
2,547,340 A 4/1951 Mullan
2,547,524 A 4/1951 Gross
2,549,228 A 4/1951 Ostrander
2,583,961 A 1/1952 Nash
2,595,981 A * 5/1952 Prickett A45C 11/324
70/456 R
2,600,749 A 6/1952 Gallagher
2,625,814 A 1/1953 Mullan
2,637,994 A 5/1953 Harrison
2,659,231 A 11/1953 Glubiak
D172,355 S 6/1954 Zimmer
2,699,667 A 1/1955 Mark
2,790,319 A * 4/1957 Brunner A45C 11/324
70/456 R
2,836,053 A 5/1958 Slarreit
2,869,232 A * 1/1959 Kivela B26B 1/046
30/161
2,882,710 A 4/1959 Furn
D185,686 S 7/1959 Trenson
2,931,208 A 4/1960 Prim
2,964,937 A 12/1960 Laufin
2,969,668 A 1/1961 Aitchison
2,978,897 A 4/1961 Capitani
2,989,861 A 6/1961 Schefman
3,004,422 A 10/1961 Starrett
D198,910 S 8/1964 Stolarz
3,277,680 A 10/1966 Merila
3,299,930 A 1/1967 Schumer
D206,875 S 2/1967 Mosch
3,355,917 A 12/1967 Albert
3,363,440 A 1/1968 Rivers
3,394,565 A 7/1968 Turman
3,407,021 A 10/1968 Mosch
3,407,636 A 10/1968 Kovacevic
3,421,349 A 1/1969 St. Clair
3,455,131 A 7/1969 Shofner
3,527,072 A 9/1970 Demetreon
3,606,777 A 9/1971 Watson
3,672,192 A 6/1972 Dontas
3,677,044 A 7/1972 De Frees

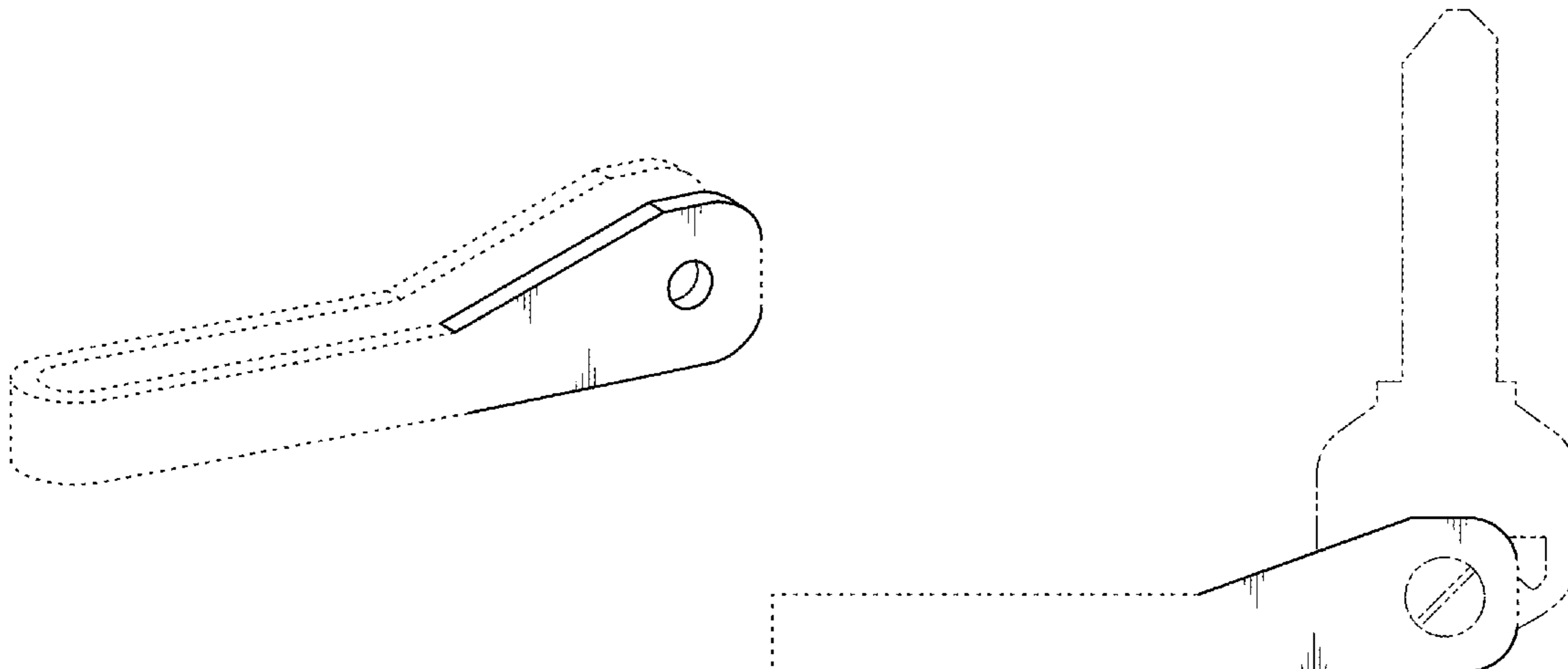

3,696,649 A 10/1972 Chow et al.
 3,882,702 A 5/1975 Wiczer
 D237,561 S 11/1975 Kesner
 3,931,688 A 1/1976 Owens
 D248,960 S 8/1978 Iverson
 4,149,812 A 4/1979 Huffman, Jr.
 4,253,321 A 3/1981 Sorensen
 4,297,864 A 11/1981 Beier
 4,351,173 A 9/1982 Toyoda
 4,417,612 A 11/1983 Couture et al.
 4,454,737 A 6/1984 Toyoda
 4,524,594 A 6/1985 Bascou
 4,549,827 A 10/1985 Mack
 4,569,215 A 2/1986 McCarthy
 4,571,967 A 2/1986 Jacobsen
 4,658,479 A 4/1987 Sanders
 4,901,547 A 2/1990 Dal Palu'
 4,939,917 A 7/1990 Cartwright
 4,941,569 A 7/1990 Lindmayer et al.
 D310,101 S 8/1990 Gauthier
 4,951,489 A 8/1990 Proch
 D310,449 S 9/1990 Agrippino
 5,117,666 A 6/1992 Keefer
 D332,384 S 1/1993 Dague
 D334,528 S 4/1993 Franklin
 5,199,560 A 4/1993 Lee et al.
 5,207,082 A 5/1993 LeMaitre
 D356,019 S 3/1995 Sakai
 D357,166 S 4/1995 Concari
 5,460,022 A 10/1995 Parsons
 D364,269 S 11/1995 Sabosky
 5,544,510 A 8/1996 Botteon et al.
 5,568,741 A 10/1996 Parsons
 D382,190 S 8/1997 Blackston et al.
 D385,301 S 10/1997 Wang
 5,704,235 A 1/1998 Stahle
 5,704,236 A 1/1998 Parsons
 5,711,194 A 1/1998 Anderson
 5,732,579 A 3/1998 D'Hont et al.
 5,768,925 A 6/1998 Ozawa et al.
 5,791,211 A 8/1998 Bondhus et al.
 D402,459 S 12/1998 Steinmacher
 D404,284 S 1/1999 Sacco et al.
 D405,675 S 2/1999 Rivera
 D405,953 S 2/1999 Legg
 D410,189 S * 5/1999 Wehrs A45C 11/324
 D8/105
 D415,343 S 10/1999 Maddox
 6,016,676 A 1/2000 McConnell
 D423,209 S 4/2000 Guyot
 D427,501 S 7/2000 Berg et al.
 6,106,131 A 8/2000 Hao
 D434,302 S 11/2000 Van Den Acker
 6,164,102 A 12/2000 Gapco
 D442,060 S 5/2001 Neset
 D442,061 S 5/2001 Harris et al.
 D442,466 S 5/2001 Van Den Acker
 D444,502 S 7/2001 Luntz
 6,282,996 B1 9/2001 Berg et al.
 6,464,419 B1 10/2002 Chan
 D469,806 S 2/2003 Chan
 D473,710 S 4/2003 Szilva
 D478,207 S 8/2003 Johnson
 D485,297 S 1/2004 Reda et al.
 6,684,673 B2 2/2004 Florendo
 6,763,938 B1 7/2004 Nelson
 D498,259 S 11/2004 Kung
 D499,764 S 12/2004 Arnold
 6,892,558 B2 5/2005 Chodosh
 D509,538 S 9/2005 Yeh
 D514,310 S 2/2006 Roye
 7,032,419 B2 4/2006 Booker
 D528,163 S 9/2006 Mandel
 7,125,186 B1 10/2006 Stokes
 7,127,922 B2 10/2006 Khounsombath et al.
 D539,526 S 4/2007 Stein
 D542,617 S * 5/2007 Liu D8/105
 D579,494 S 10/2008 Chan et al.
 D593,318 S 6/2009 Kelleghan

D624,305 S 9/2010 Downes
 D626,590 S 11/2010 Pugilisi
 8,182,166 B2 5/2012 Colman
 D665,992 S 8/2012 Wilbur
 D674,590 S 1/2013 Busch
 D680,733 S 4/2013 Aprea
 D683,951 S 6/2013 Busch
 8,493,369 B2 7/2013 Liang et al.
 D693,202 S 11/2013 Berman
 D705,533 S 5/2014 Tunney
 D709,344 S 7/2014 Adelman et al.
 D714,537 S 10/2014 Busch
 D714,539 S 10/2014 Busch
 D728,922 S 5/2015 Taylor
 D730,446 S 5/2015 Busch
 D754,427 S 4/2016 Tunney
 D754,428 S 4/2016 Tunney
 D756,629 S 5/2016 Tunney
 D756,630 S 5/2016 Tunney
 D759,755 S 6/2016 Busch
 D771,936 S 11/2016 Shlaferman
 D833,139 S * 11/2018 Hadden A45C 11/324
 D3/207
 D839,588 S * 2/2019 Busch D3/207
 D858,087 S * 9/2019 Julianloo D3/207
 2011/0015937 A1 1/2011 Downes
 2019/0289973 A1* 9/2019 Van Der Laan A45C 11/324

FOREIGN PATENT DOCUMENTS

CN 2691863 4/2005
 CN 201131411 10/2008
 CN 201494157 6/2010
 CN 201552879 8/2010
 CN 202782316 3/2013
 CN 203077923 7/2013

OTHER PUBLICATIONS

Jag-Engr, "Consolidated Pocket& Keychain Organization Thread," EDCForums (Nov. 24, 2011).
 Ethanf, "Do you hate your keys jingling? (Bicycle Content)," EDCForums (Sep. 12, 2011).
 Anonymous, "Products," Down Home Leather, Nov. 24, 2011.
 Anonymous, "Novel Key Holder," Popular Mechanics at p. 161 (Jan. 1923).
 Anonymous, "Key & Holders," Able Home Aides (Nov. 24, 2011).
 Crew, "My new custom 'multi-key', made from a Gerber Curve!," EDCForums (Dec. 1, 2010).
 Legoman0721, "Cold Steel Mini Tac Tanto," EDCForums (Nov. 24, 2010).
 Aphi, "Switchkey," EDCForums (Dec. 19, 2010).
 Shadeone, "The Real Leatherman KEYman! My custom Multi-Key!!," EDCForums (Aug. 6, 2007).
 Anonymous, "Master Key Set," T-Parts (Date Unknown).
 Anonymous, "True Utility® Keyring System," True Utility (Date Unknown).
 Dieck, "Ultra Ultra minimalist keyring," EDCForums (May 29, 2008).
 Diaz, Oscar, "While u sleep," Oscar Diaz Studio (Date Unknown).
 Wild Style, "Wild style's daily carry," EDCForums (Oct. 21, 2009).
 Anonymous, "Carrying Keys," Carryology (Jun. 3, 2010).
 Busch, "Photo Set 1," (Jul. 8, 2007).
 Busch, "Photo Set 2," (Jul. 8, 2007).
 F3RG, "Crank Bros. Folding Keychain," Mtbr Forums (Jan. 29, 2009).
 Anonymous, "Photo Of Keys" (Date Unknown).
 PYRO222, "Multi tool Keys—Mod / Hack," Instructables (Jul. 20, 2008).
 Anonymous, "Compact Key Chain," Sagawisiw (Jun. 10, 2012).
 Lota, Jon, "KeyFlip," Kickstarter.com (Jan. 25, 2013) (printed Jun. 9, 2013).
 Tunney, Michael Patrick, "SmartKey," Kickstarter.com (May 5, 2013) (printed Jun. 9, 2013).

Anonymous, "Nail-file-pen," HALSUN International (Date Unknown) (printed Apr. 21, 2014).

Anonymous, "Signature Item No. 54104," Victorinox (Date Unknown) (printed Apr. 21, 2014).

Anonymous, "Retractable Pen Refill Item No. 30459," Victorinox (Date Unknown) (printed Apr. 21, 2014).

Anonymous, "Ballpoint Pen, Large Item No. 30422," Victorinox (Date Unknown) (printed Apr. 21, 2014).

Anonymous, "Ballpoint Pen, Large Item No. 30422," Victorinox (Date Unknown) (printed Apr. 22, 2014).

* cited by examiner

Primary Examiner — Kevin K Rudzinski

Assistant Examiner — Amber J Rabie

(74) *Attorney, Agent, or Firm* — James David Busch

(57) **CLAIM**

I claim the ornamental design for a component of a pocket key organizer, substantially as shown and described.

DESCRIPTION

FIG. 1 is a front perspective view of the component of a pocket key organizer;

FIG. 2 is a front view of FIG. 1;

FIG. 3 is a rear view of FIG. 1;

FIG. 4 is a left side view of FIG. 1;

FIG. 5 is a right side view of FIG. 1;

FIG. 6 is a top view of FIG. 1;

FIG. 7 is a bottom view of FIG. 1;

FIG. 8 is a front perspective view of a second application of the component of a pocket key organizer;

FIG. 9 is a front view of FIG. 8;

FIG. 10 is a rear view of FIG. 8;

FIG. 11 is a left side view of FIG. 8;

FIG. 12 is a right side view of FIG. 8;

FIG. 13 is a top view of FIG. 8;

FIG. 14 is a bottom view of FIG. 8;

FIG. 15 is a front perspective view of a third application of the component of a pocket key organizer;

FIG. 16 is a front view of FIG. 15;

FIG. 17 is a rear view of FIG. 15;

FIG. 18 is a left side view of FIG. 15;

FIG. 19 is a right side view of FIG. 15;

FIG. 20 is a top view of FIG. 15;

FIG. 21 is a bottom view of FIG. 15;

FIG. 22 is a left side view of any of the prior applications shown in a position of use with a key;

FIG. 23 is a left side view of any of the prior applications shown in a position of use with a key rotated ninety degrees clockwise;

FIG. 24 is a front perspective view of a fourth application of the component of a pocket key organizer;

FIG. 25 is a front view of FIG. 24;

FIG. 26 is a rear view of FIG. 24;

FIG. 27 is a left side view of FIG. 24;

FIG. 28 is a right side view of FIG. 24;

FIG. 29 is a top view of FIG. 24; and,

FIG. 30 is a bottom view of FIG. 24.

The features shown in broken dotted lines represent the bounds of the claimed design, while the broken long and double short dashed lines are directed to the environment are for illustrative purposes only; the broken lines form no part of the claimed design.

1 Claim, 9 Drawing Sheets

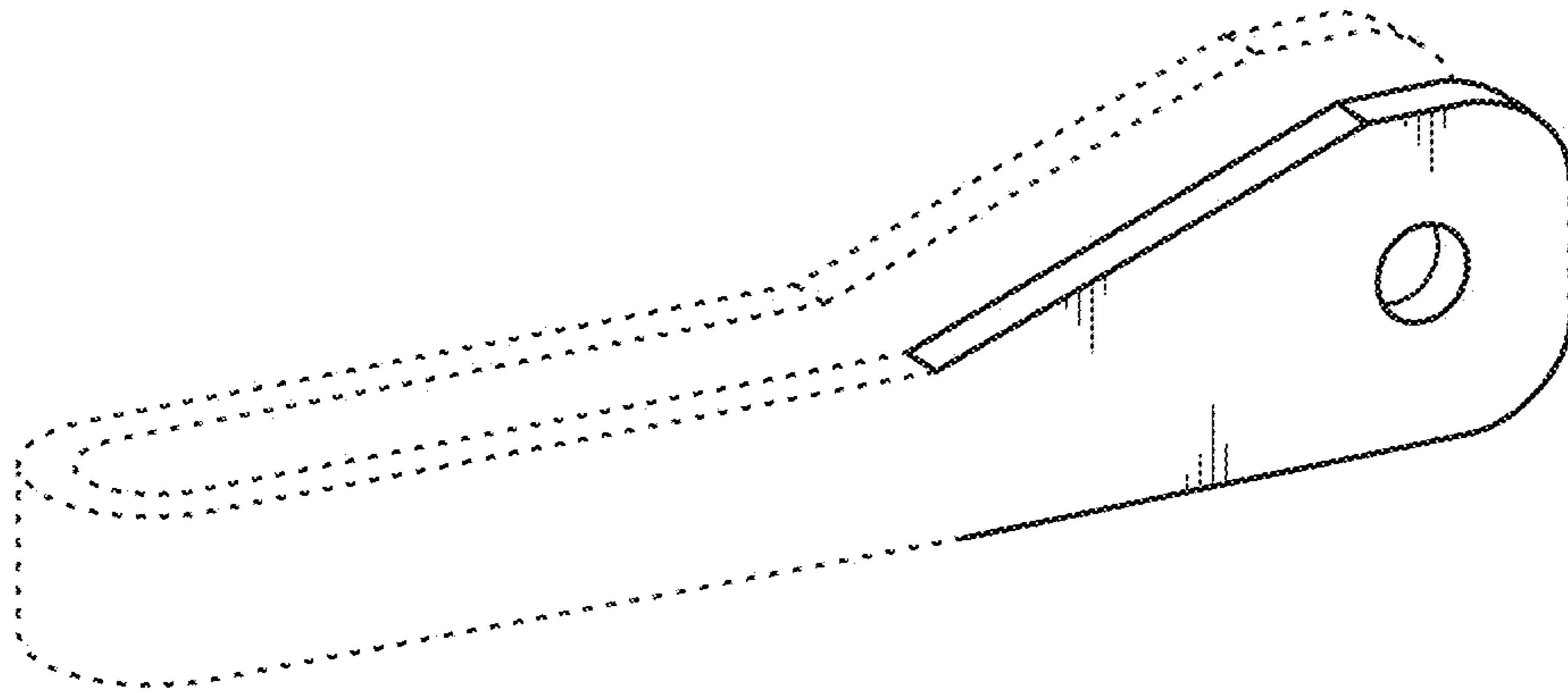

FIG. 1

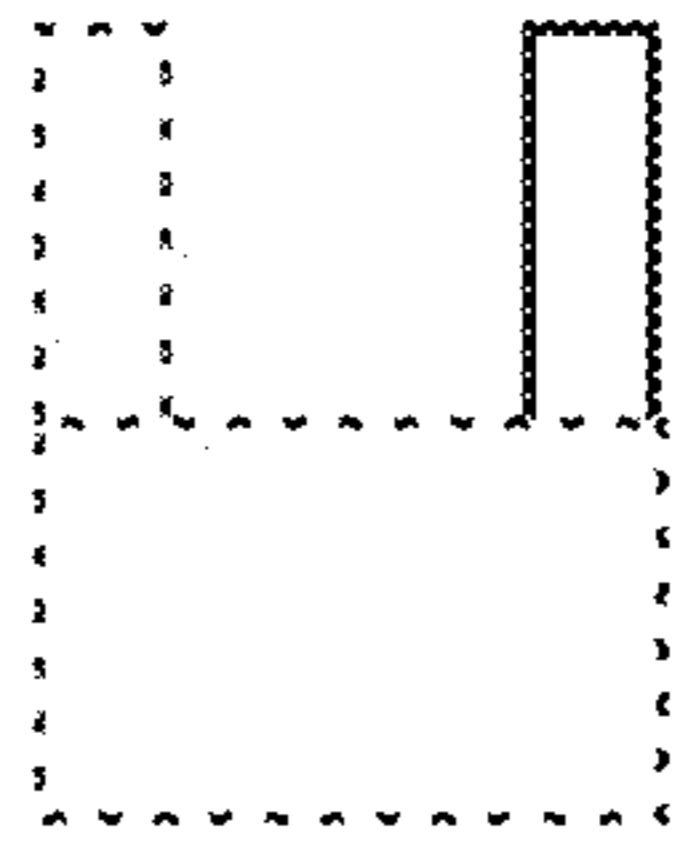

FIG. 2

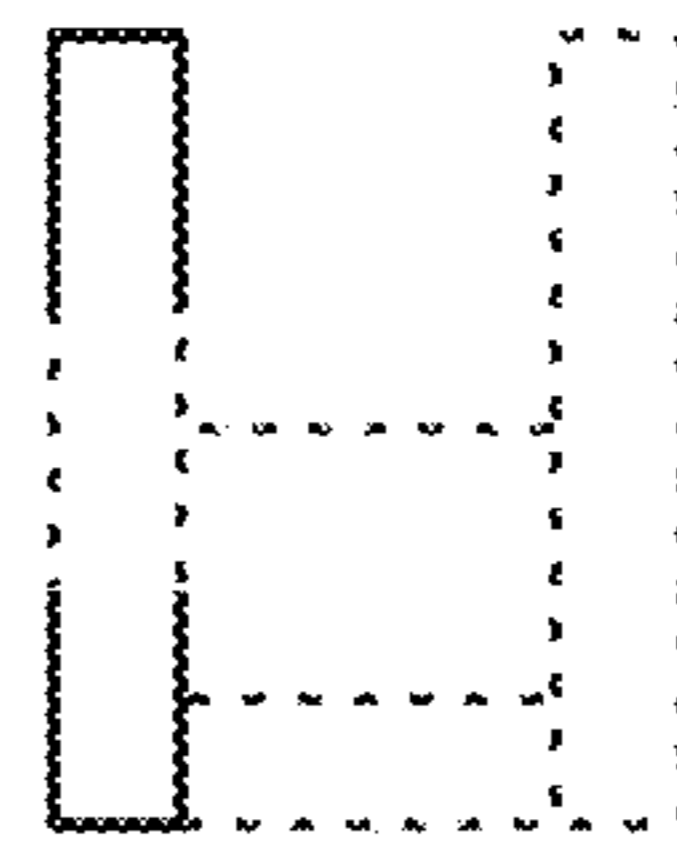

FIG. 3

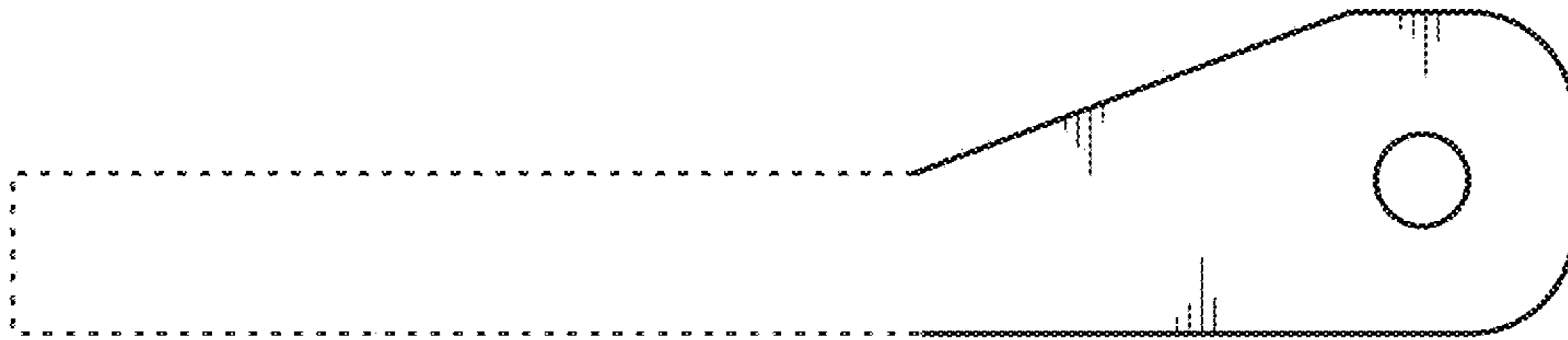

FIG. 4

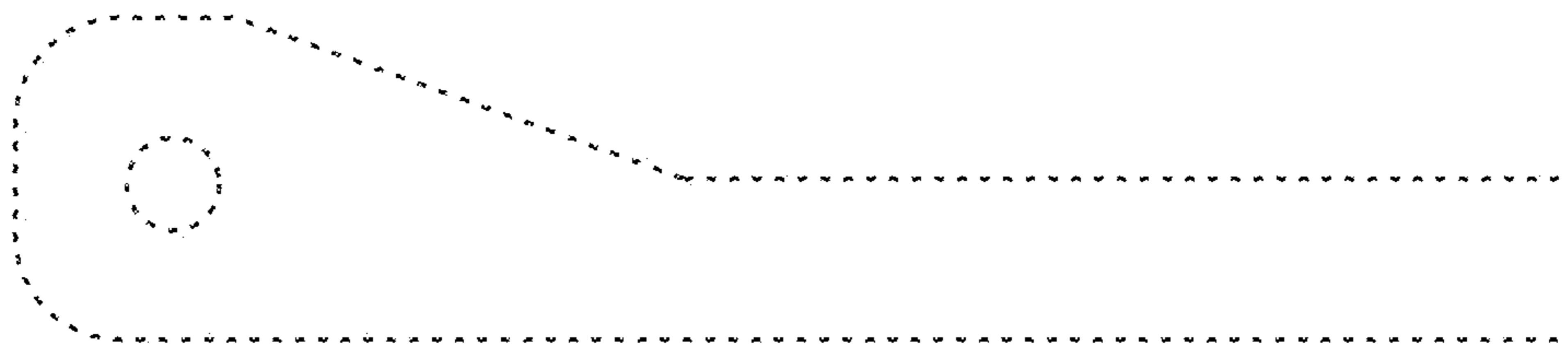

FIG. 5

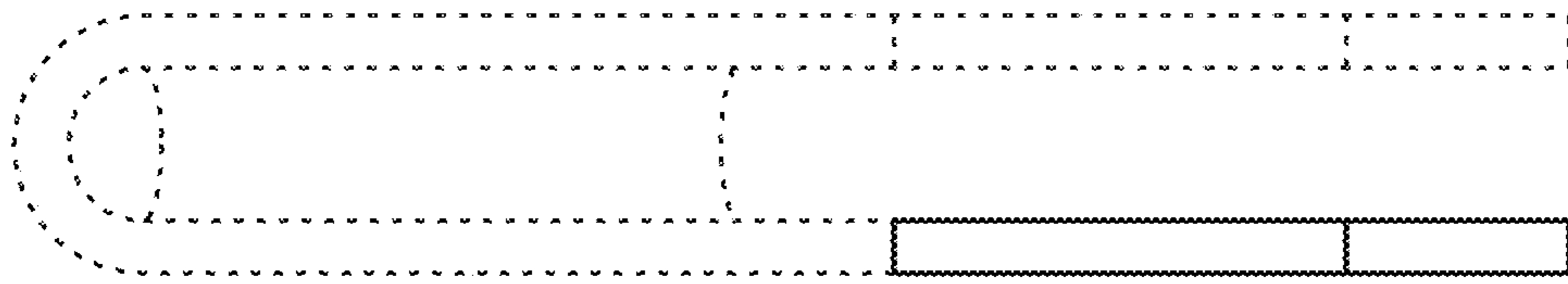

FIG. 6

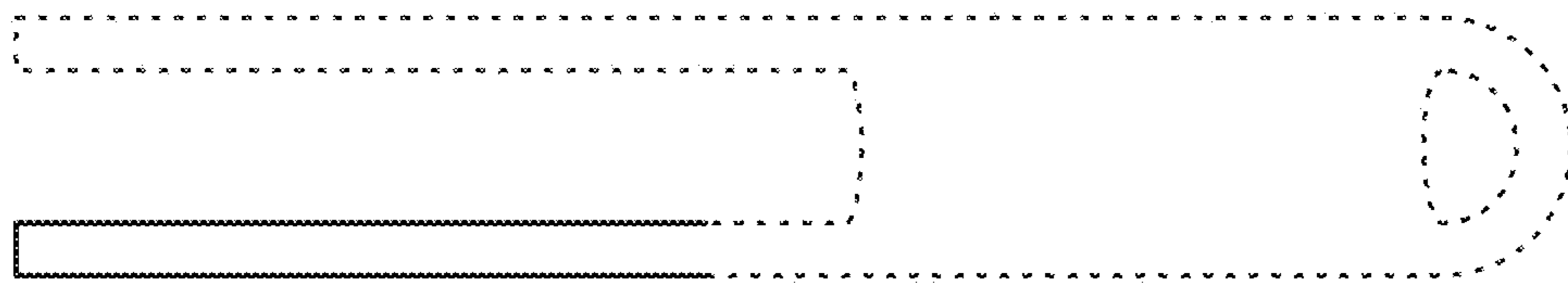

FIG. 7

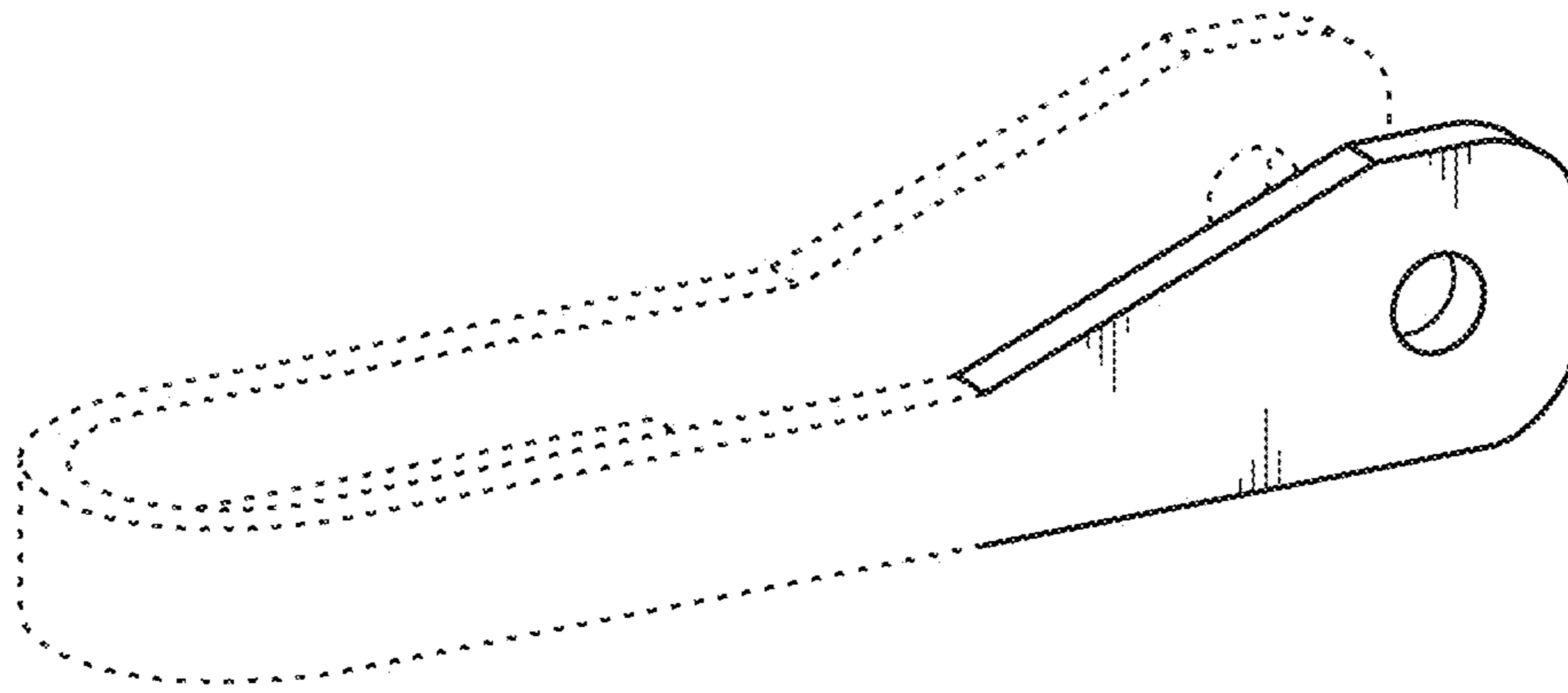

FIG. 8

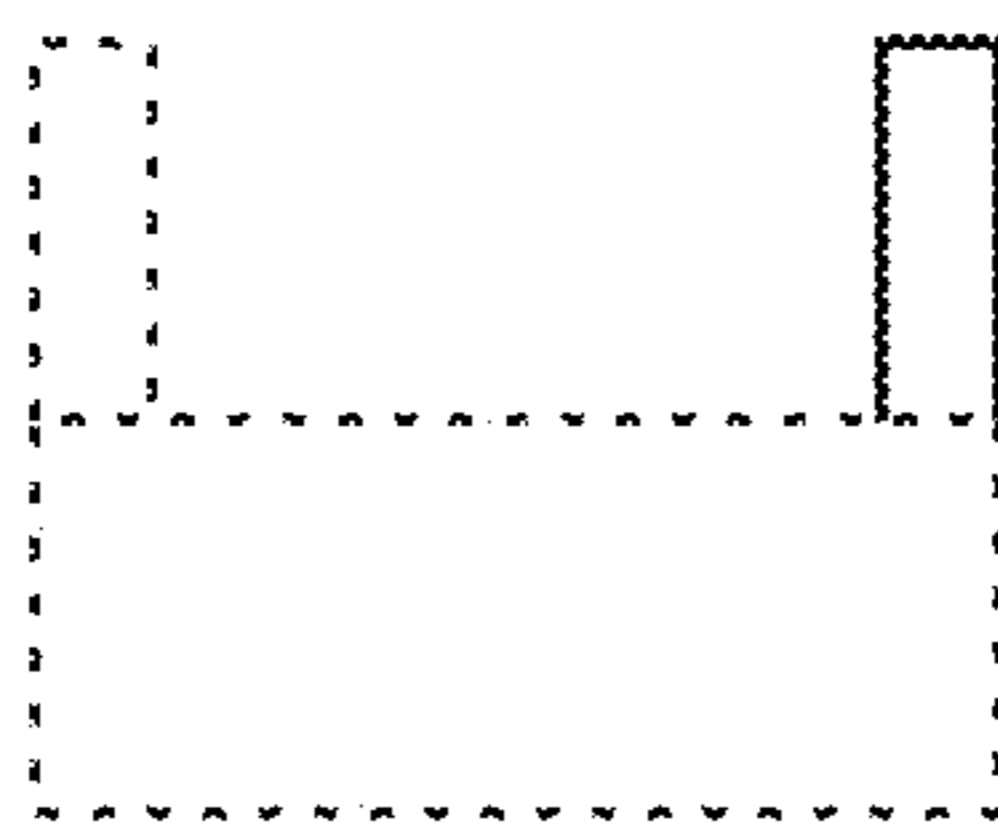

FIG. 9

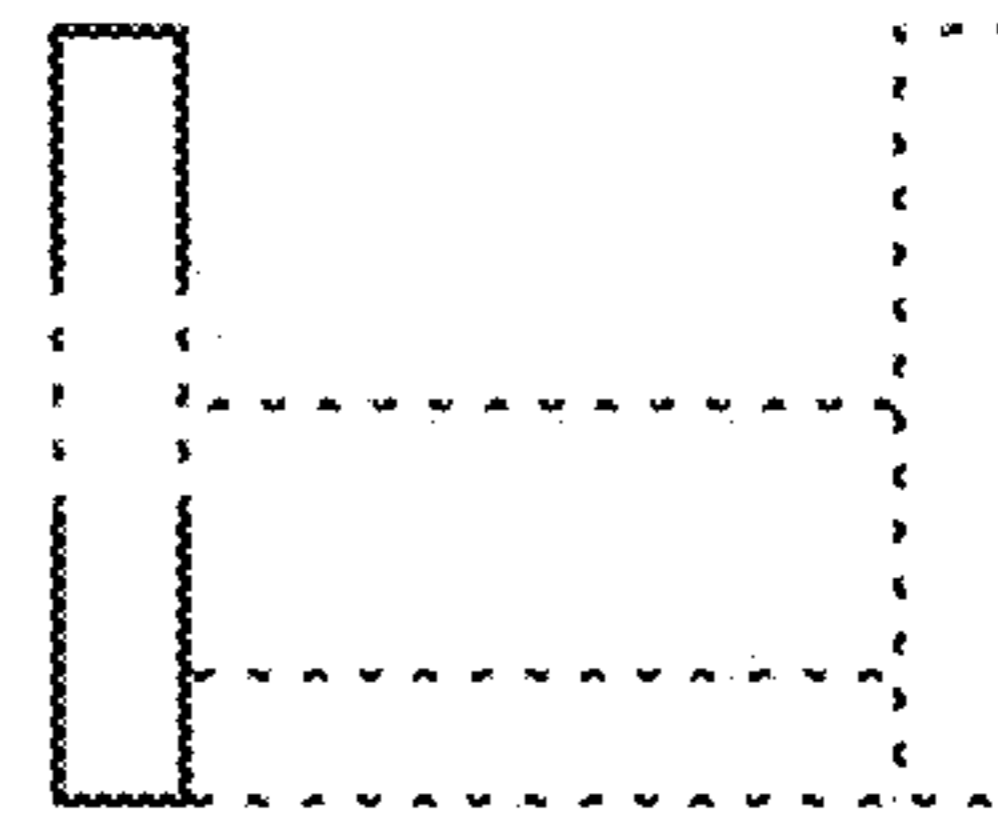

FIG. 10

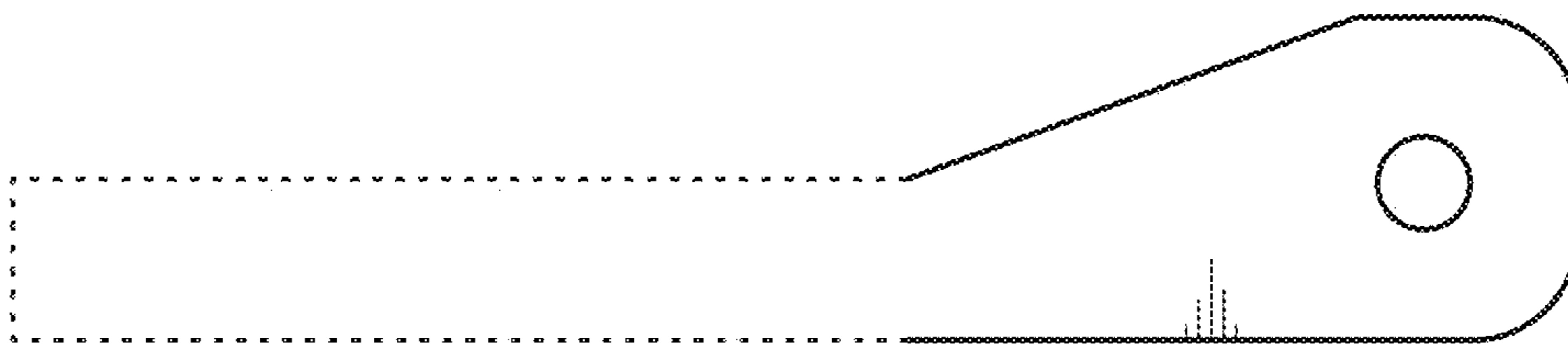

FIG. 11

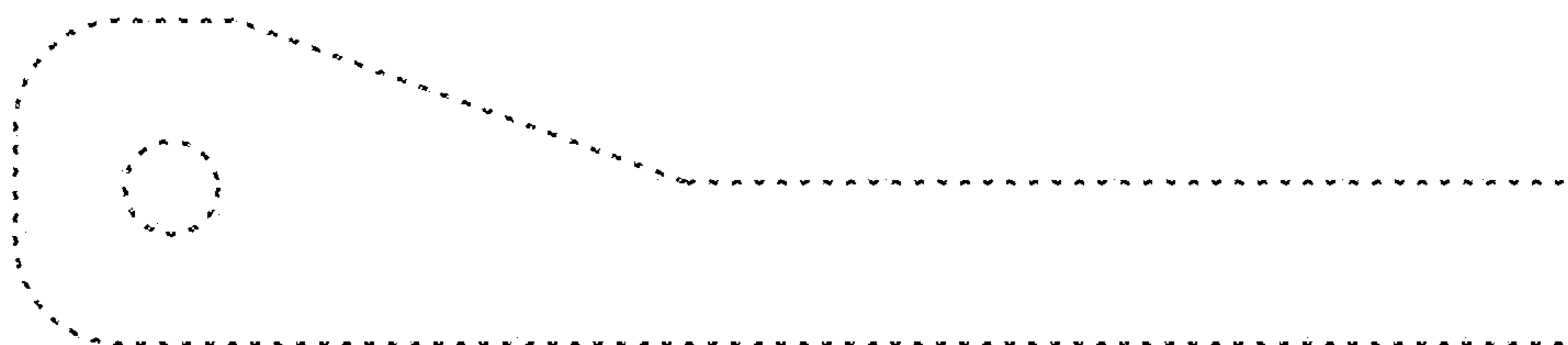

FIG. 12

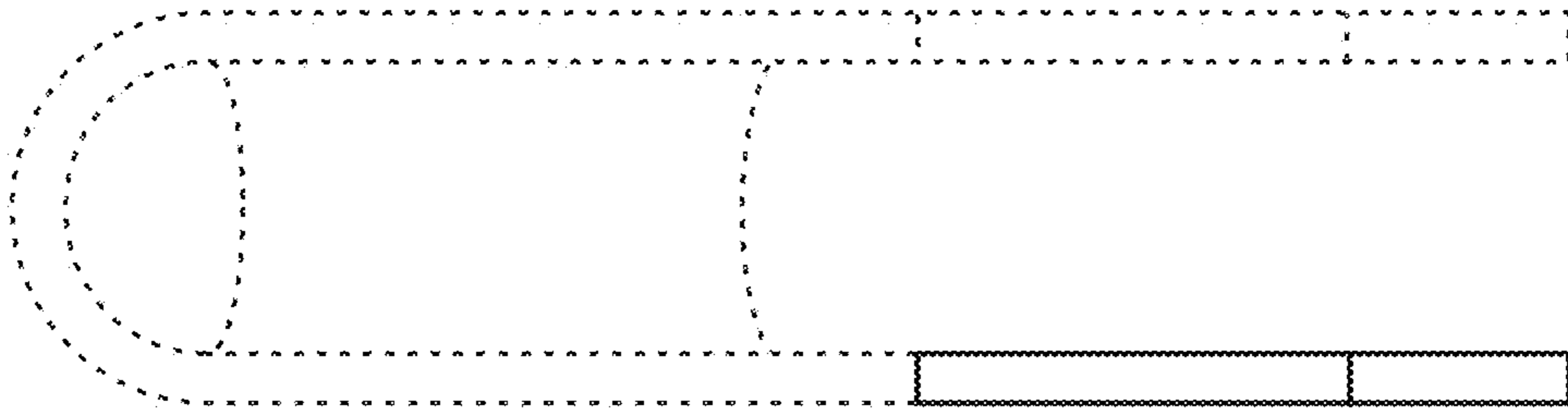

FIG. 13

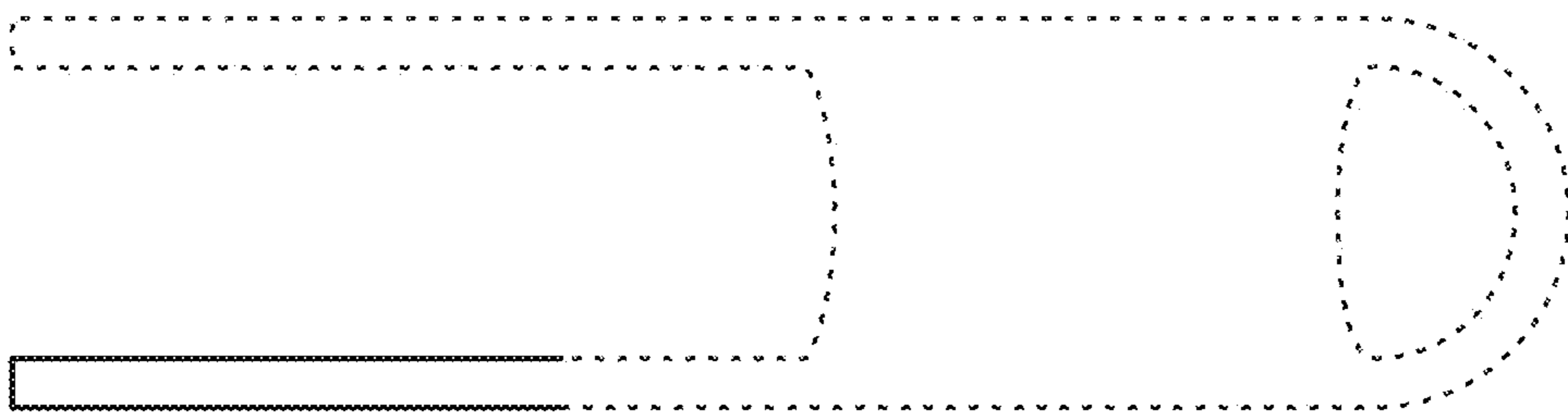

FIG. 14

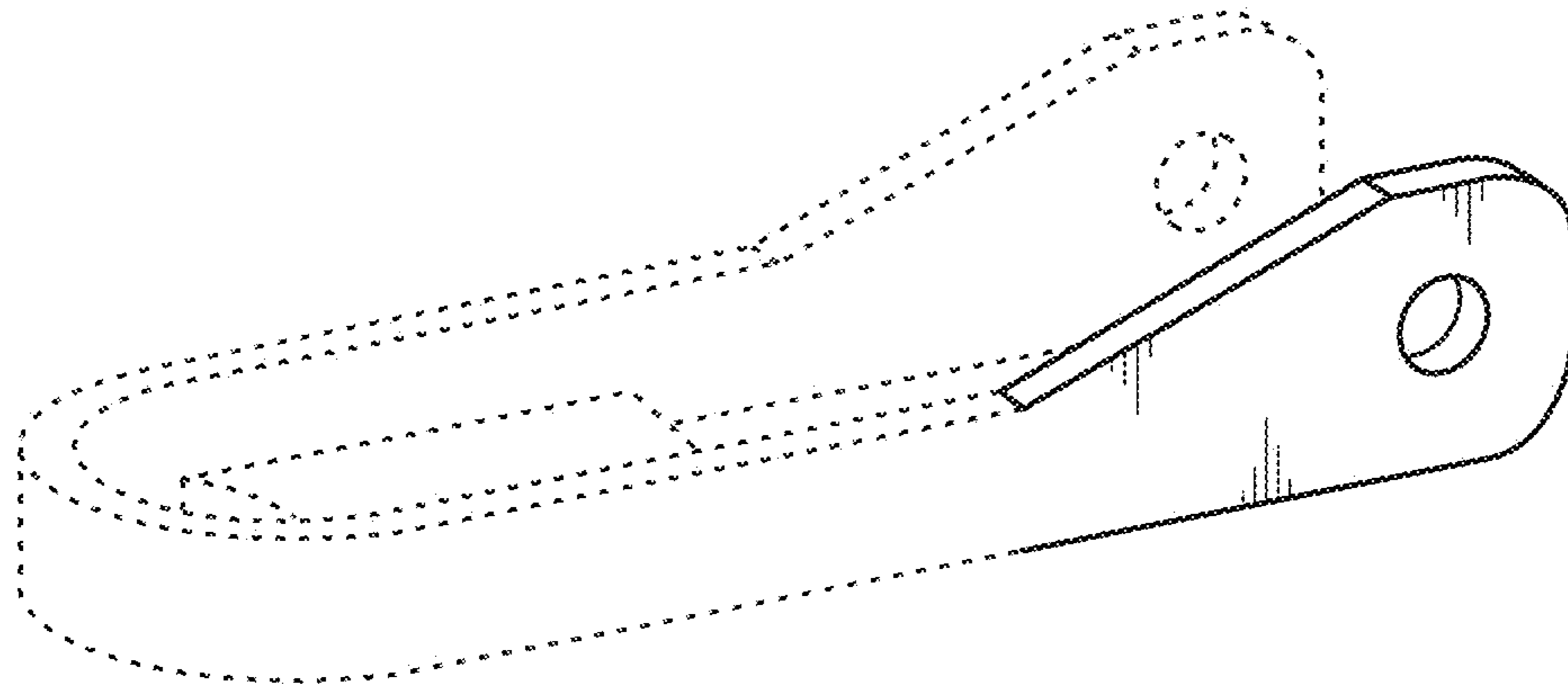

FIG. 15



FIG. 16

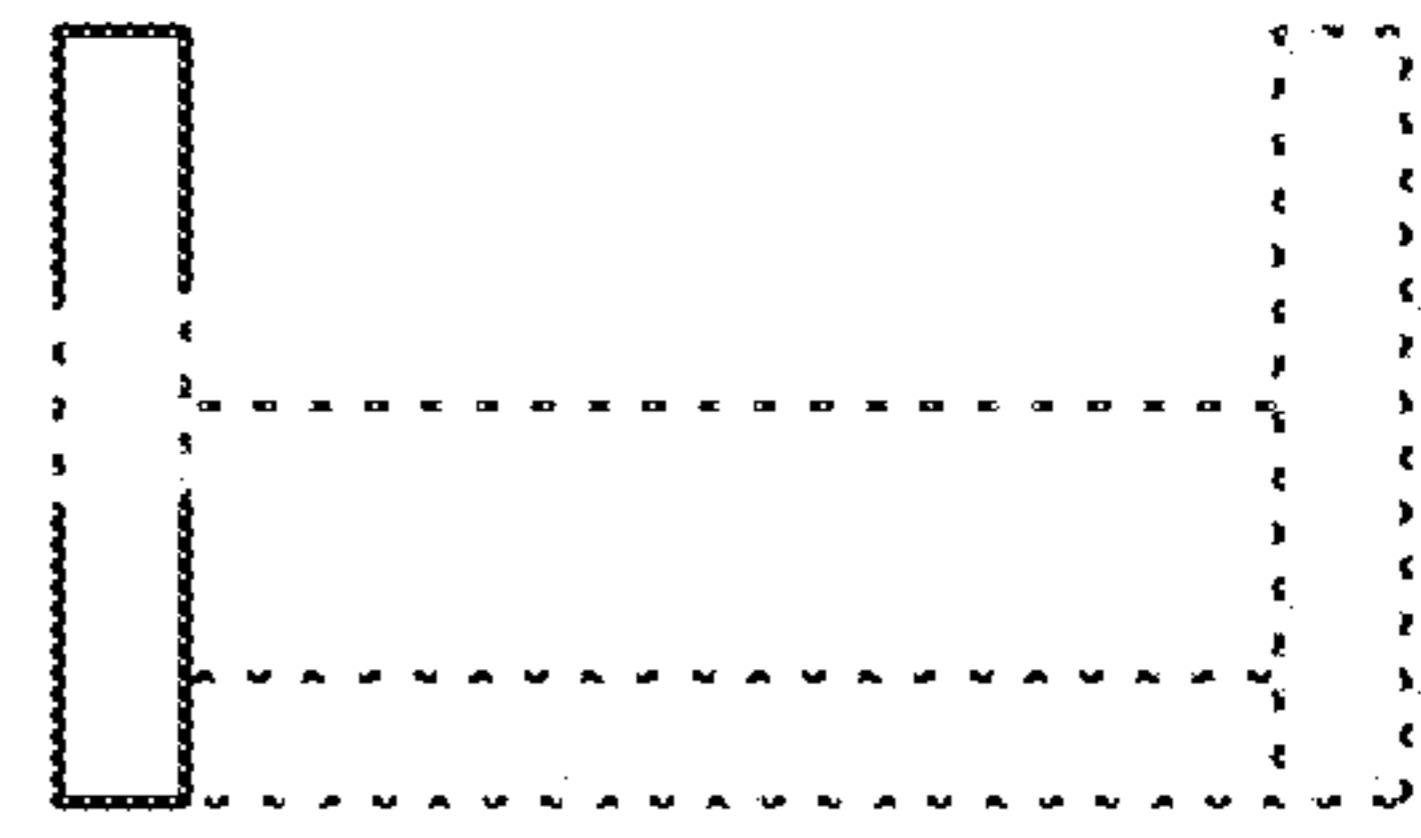

FIG. 17

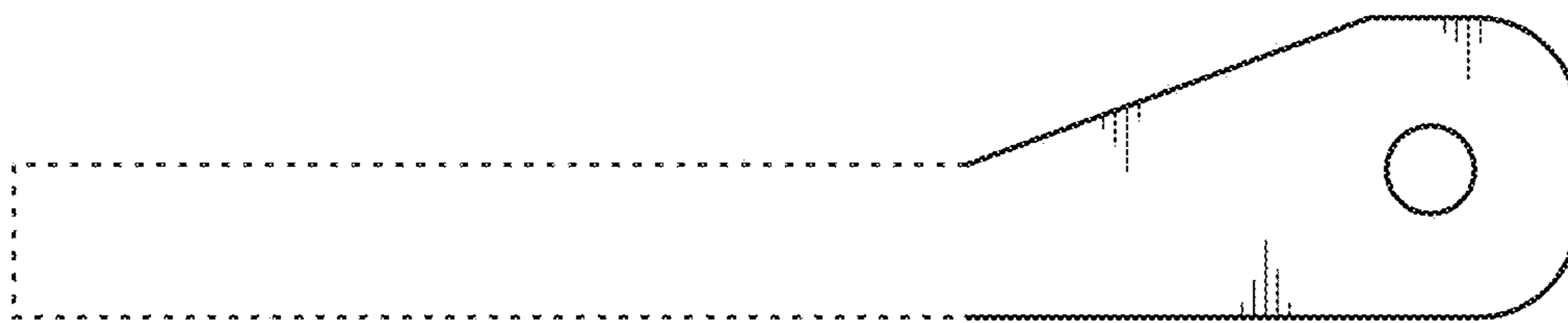

FIG. 18

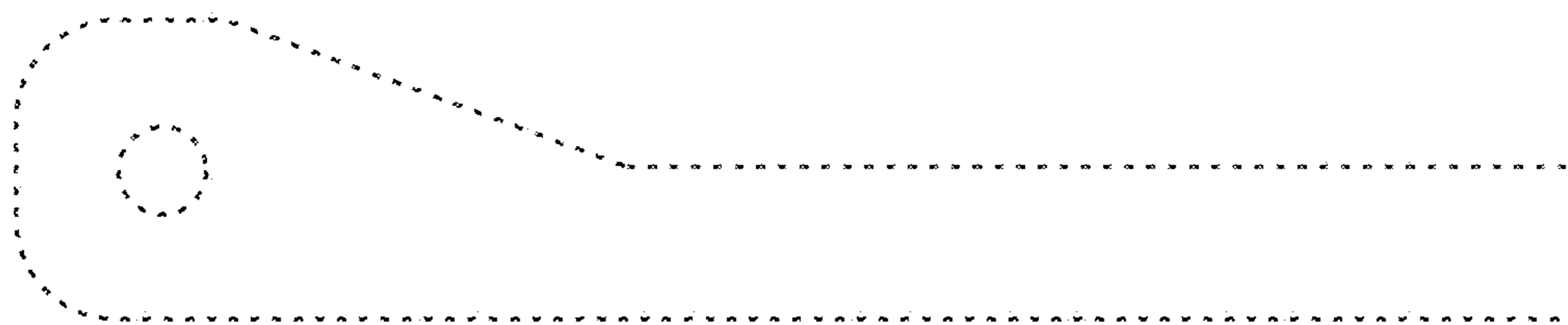

FIG. 19

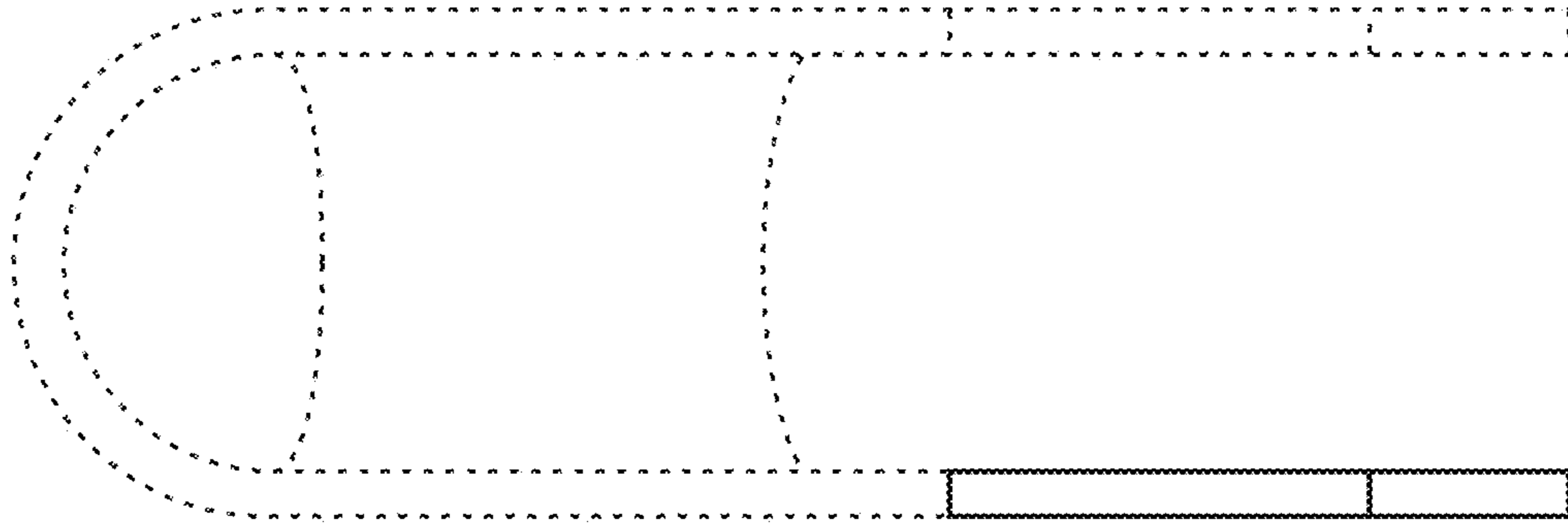

FIG. 20

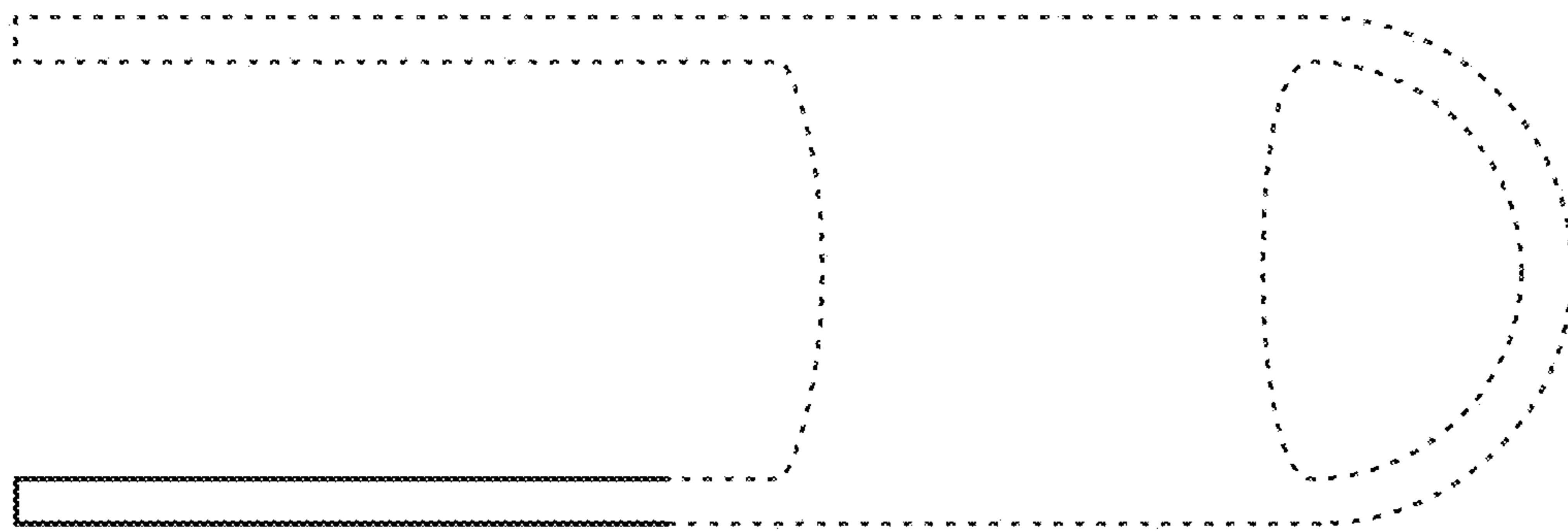

FIG. 21

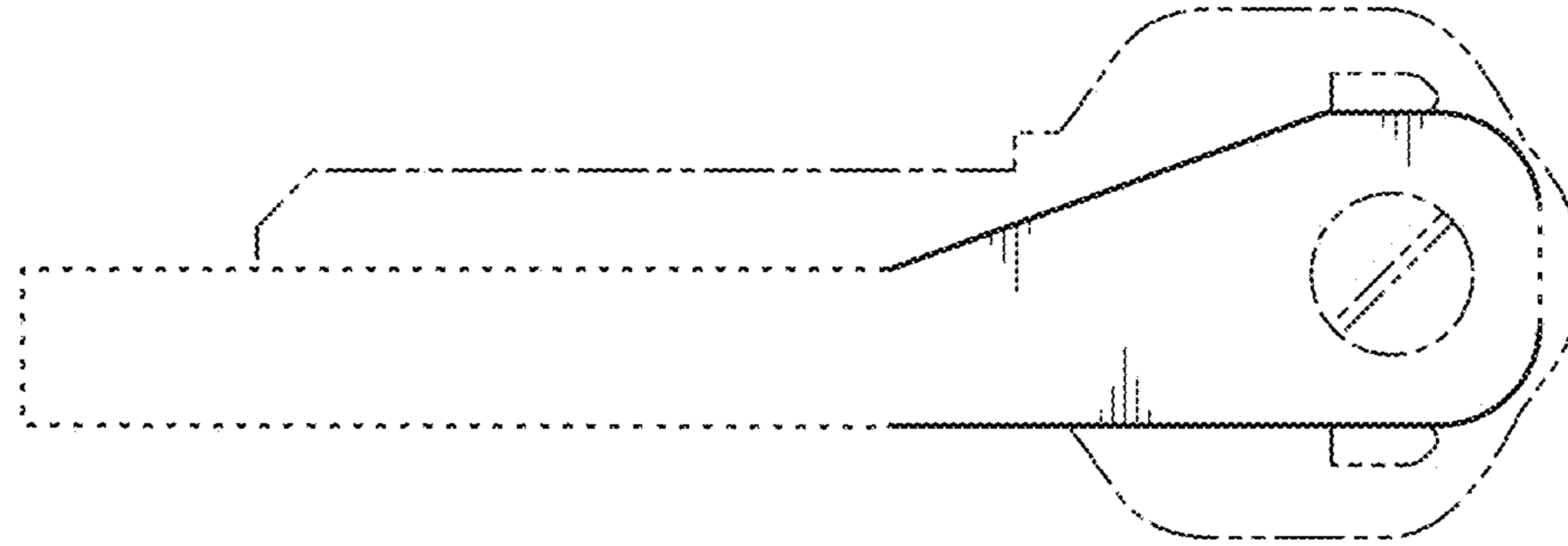

FIG. 22

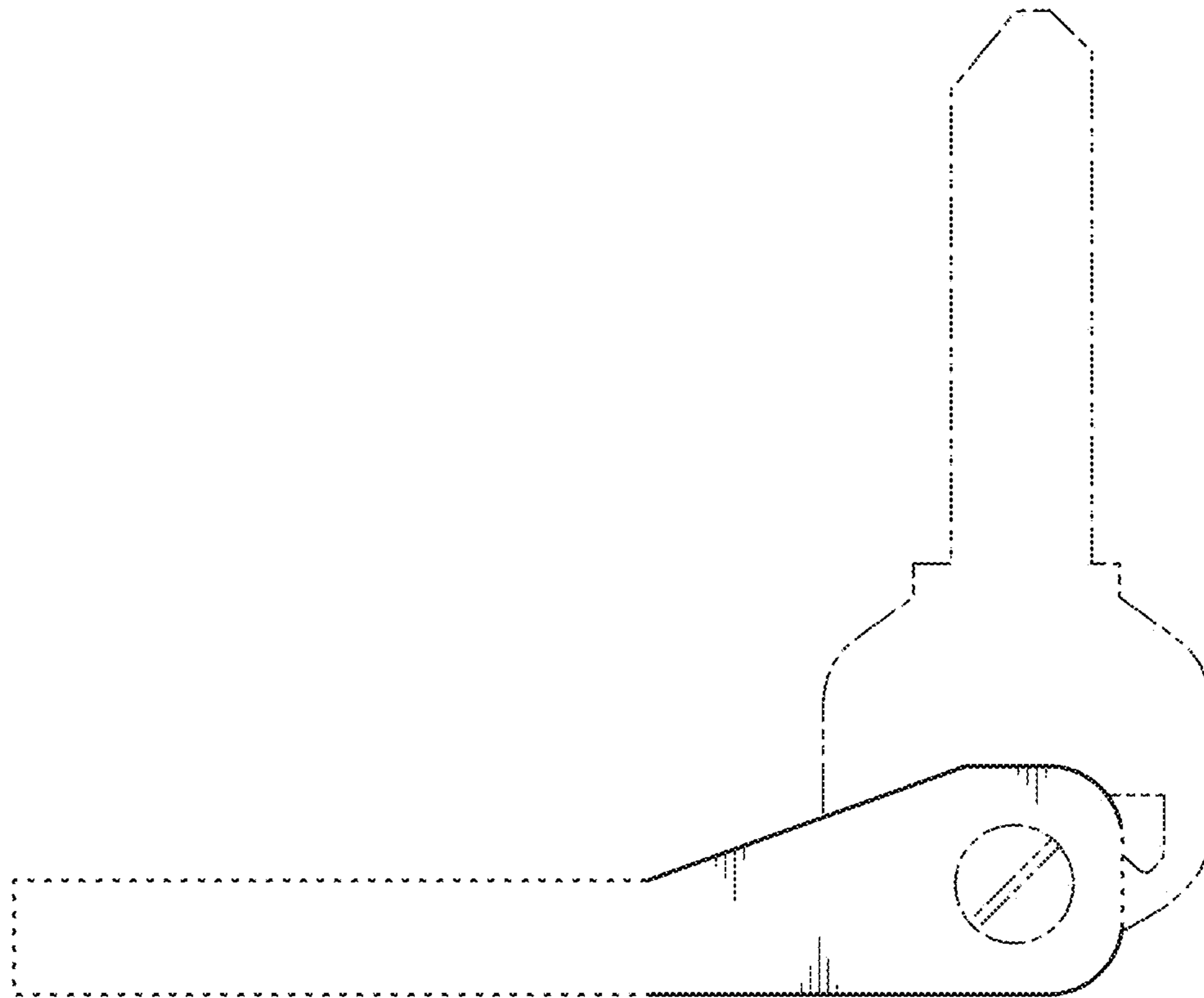

FIG. 23

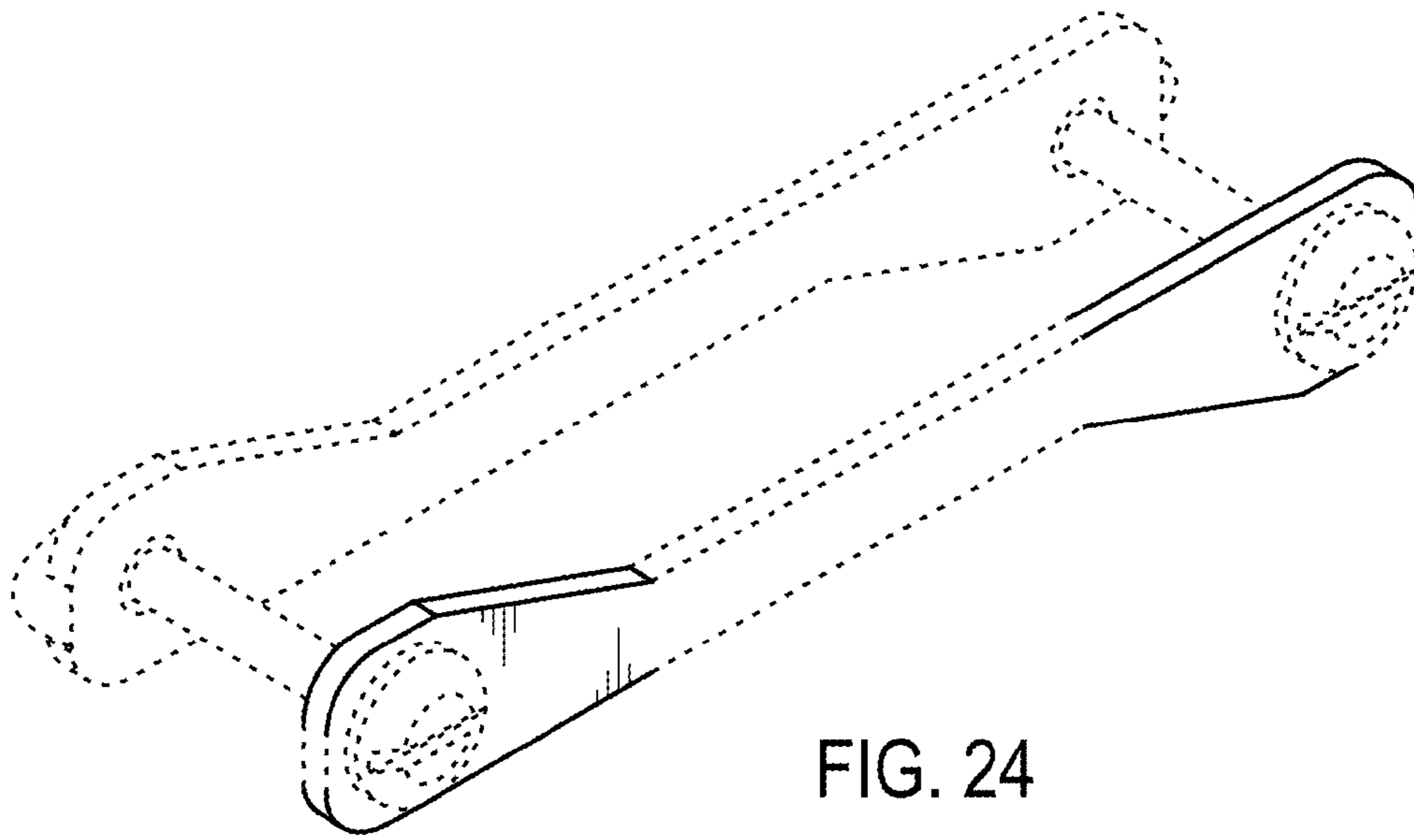

FIG. 24

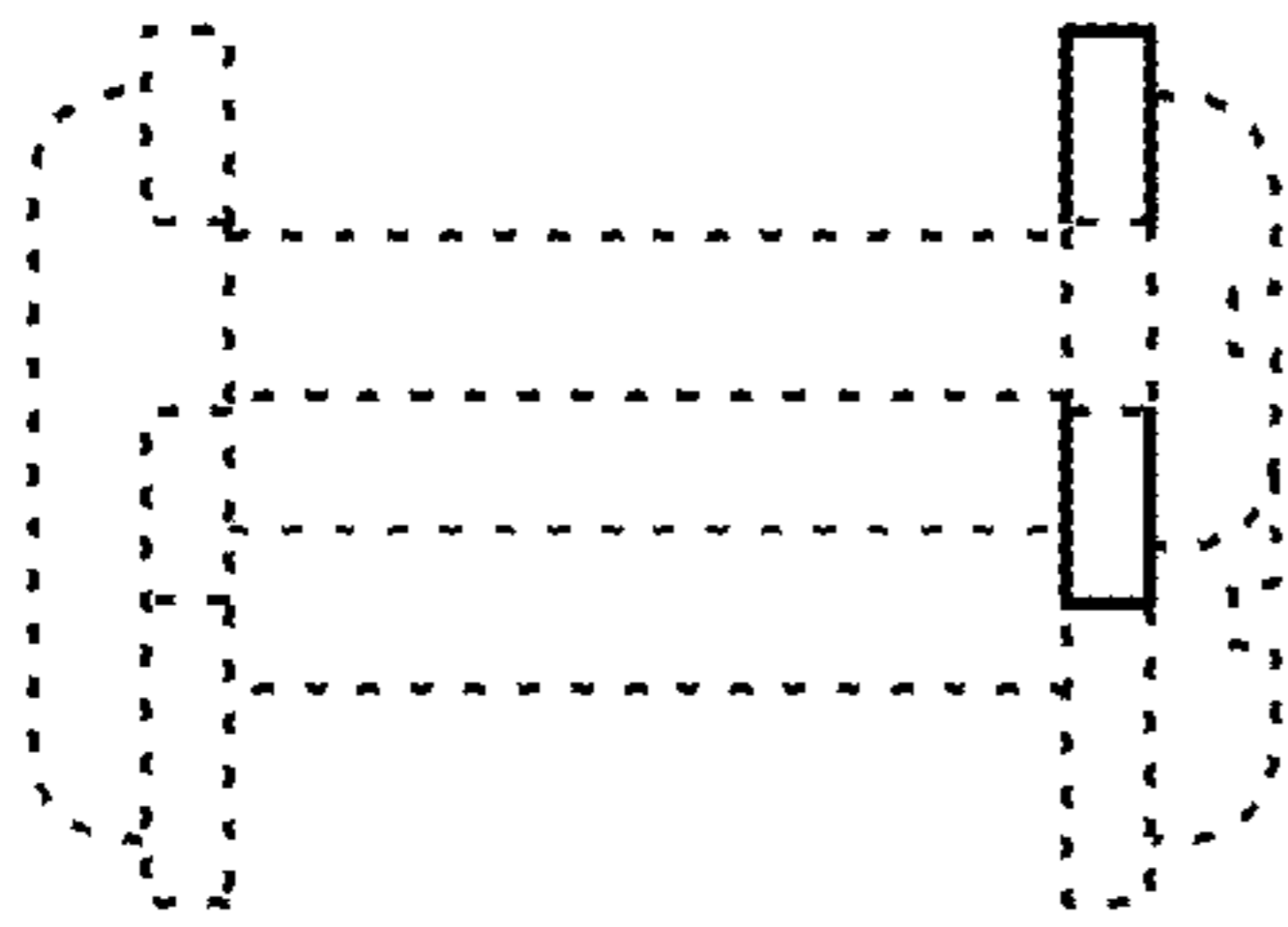

FIG. 25

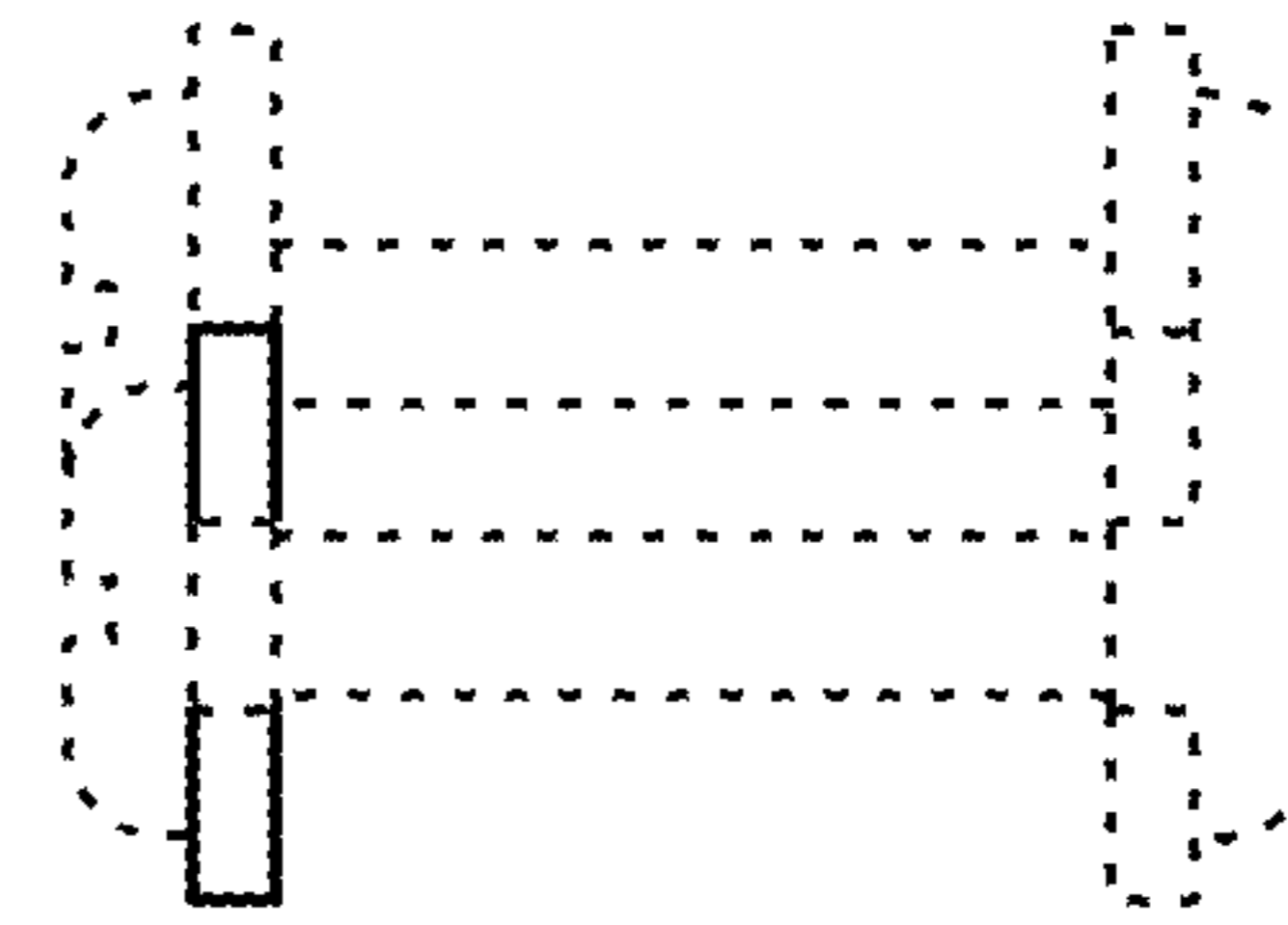

FIG. 26



FIG. 27



FIG. 28

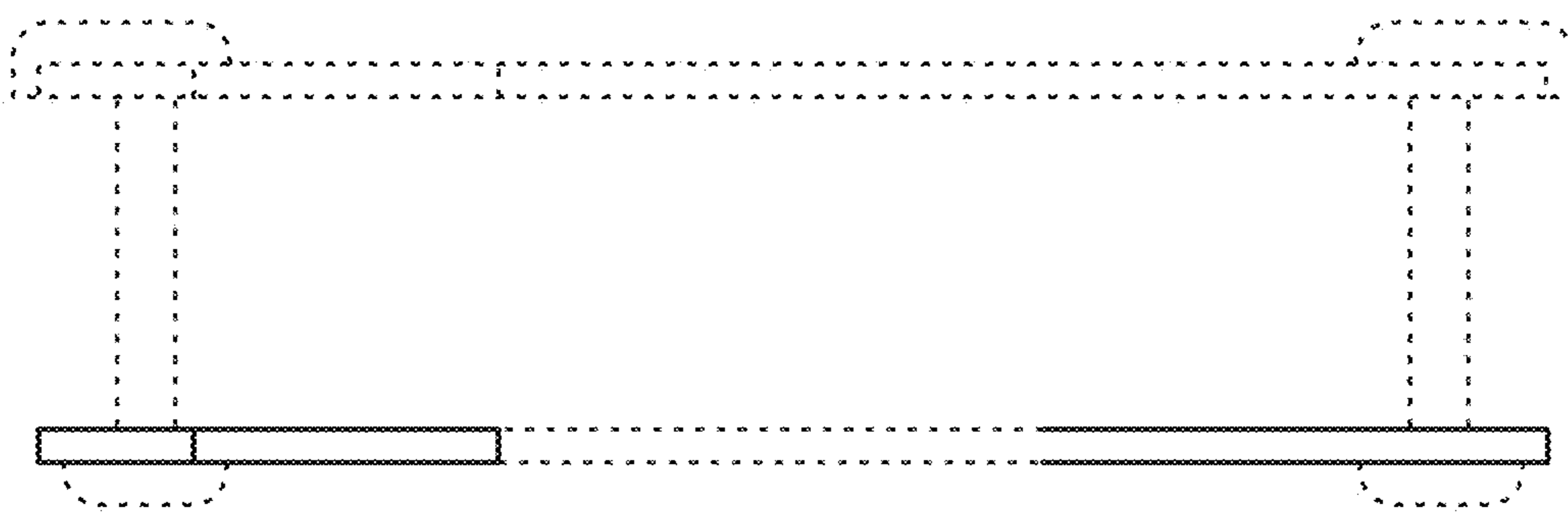

FIG. 29

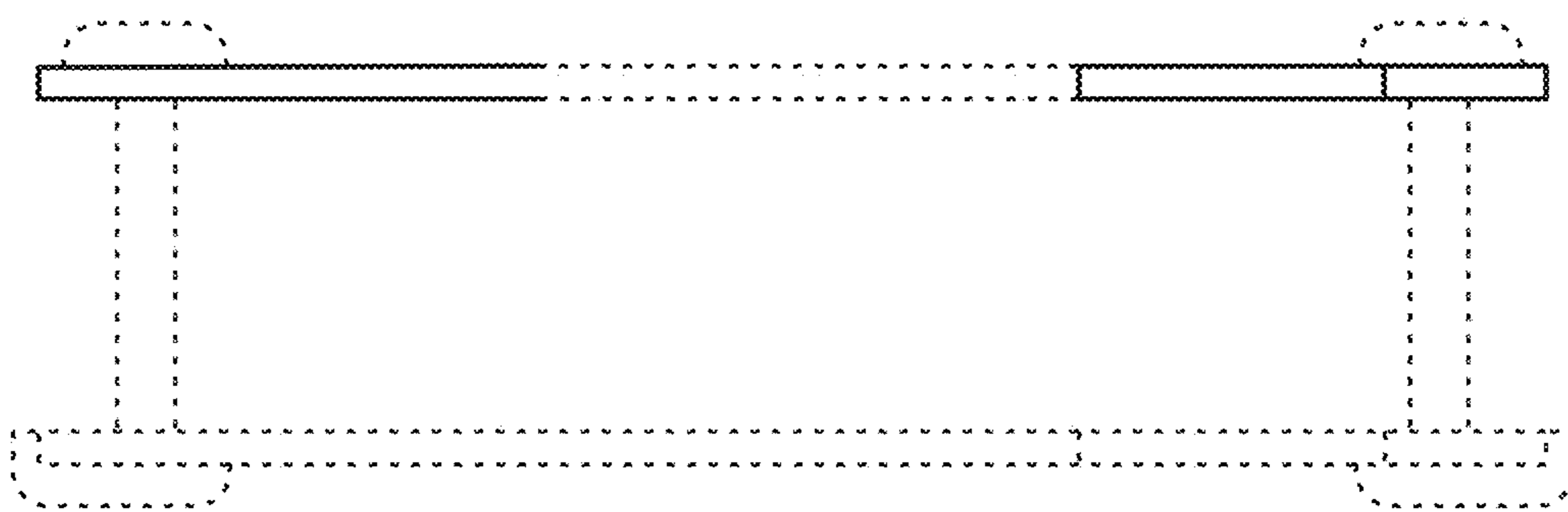

FIG. 30