



US00D906611S

(12) **United States Design Patent** (10) **Patent No.:** **US D906,611 S**  
**Tsui** (45) **Date of Patent:** **\*\* Dec. 29, 2020**

(54) **COLLAPSIBLE LAUNDRY BASKET**

FOREIGN PATENT DOCUMENTS

(71) Applicant: **Sam Tung Tsui**, Kowloon (HK)

AU 201614934 9/2016  
WO WO D084484-001 \* 10/2014

(72) Inventor: **Sam Tung Tsui**, Kowloon (HK)

(\*\*) Term: **15 Years**

OTHER PUBLICATIONS

(21) Appl. No.: **29/657,368**

“Laundry a Never Ending Cycle” Laundry Basket | Bed Bath & Beyond, reviews 2017, site visited Mar. 28, 2020, [https://www.bedbathandbeyond.com/store/product/laundry-a-never-ending-cycle-laundry- . . . \\*](https://www.bedbathandbeyond.com/store/product/laundry-a-never-ending-cycle-laundry-...)

(22) Filed: **Jul. 20, 2018**

(Continued)

(51) **LOC (12) Cl.** ..... **09-04**

(52) **U.S. Cl.**  
USPC ..... **D32/37; D3/307**

(58) **Field of Classification Search**  
USPC ..... D32/1, 14.1, 30, 35-37, 47, 58-59;  
D3/307

CPC .. A61L 2/10; A47L 25/00; A47L 23/20; B01J  
19/08; G01N 21/00; G01J 3/10; D06F  
58/04

See application file for complete search history.

*Primary Examiner* — John R Yeh

(74) *Attorney, Agent, or Firm* — Hinshaw & Culbertson  
LLP

(57) **CLAIM**

I claim the ornamental design for a collapsible laundry basket, as shown and described.

**DESCRIPTION**

(56) **References Cited**

U.S. PATENT DOCUMENTS

D199,096 S *	9/1964	Barnet et al. ....	D32/37
D264,040 S *	4/1982	Kunze .....	D32/37
D277,993 S *	3/1985	Sinchok .....	D3/309
D279,278 S *	6/1985	Pink .....	D11/143
D302,069 S *	7/1989	Yoshikawa .....	D3/312
D343,711 S *	1/1994	Craft .....	D32/37
D348,128 S *	6/1994	Craft .....	D32/37
D351,266 S *	10/1994	Licari .....	D32/37
D372,568 S *	8/1996	Lippisch .....	D32/37
D372,583 S *	8/1996	Brightbill .....	D3/312
D466,301 S *	12/2002	Sofy .....	D3/307
D477,145 S *	7/2003	Sofy .....	D3/307
7,207,460 B2 *	4/2007	Sander .....	D06F 95/002 220/676
D643,585 S *	8/2011	Duvigneau .....	D32/37
D690,891 S *	10/2013	Barre .....	D32/37
D691,341 S *	10/2013	Barre .....	D32/37

(Continued)

FIG. 1 is a front and top perspective view of a first collapsible laundry basket embodiment of the invention in a collapsed position.

FIG. 2 is a front elevation view of the first embodiment of the invention in a collapsed position.

FIG. 3 is a back elevation view of the first embodiment of the invention in a collapsed position.

FIG. 4 is a right side elevation view of the first embodiment of the invention in a collapsed position, the left side elevation view being a mirror image of the right side elevation view.

FIG. 5 is a top plan view of the first embodiment of the invention in a collapsed position; and,

FIG. 6 is a bottom plan view of the first embodiment of the invention in a collapsed position.

The broken lines in the drawings depict environment subject matter only and form no part of the claimed design.

**1 Claim, 4 Drawing Sheets**

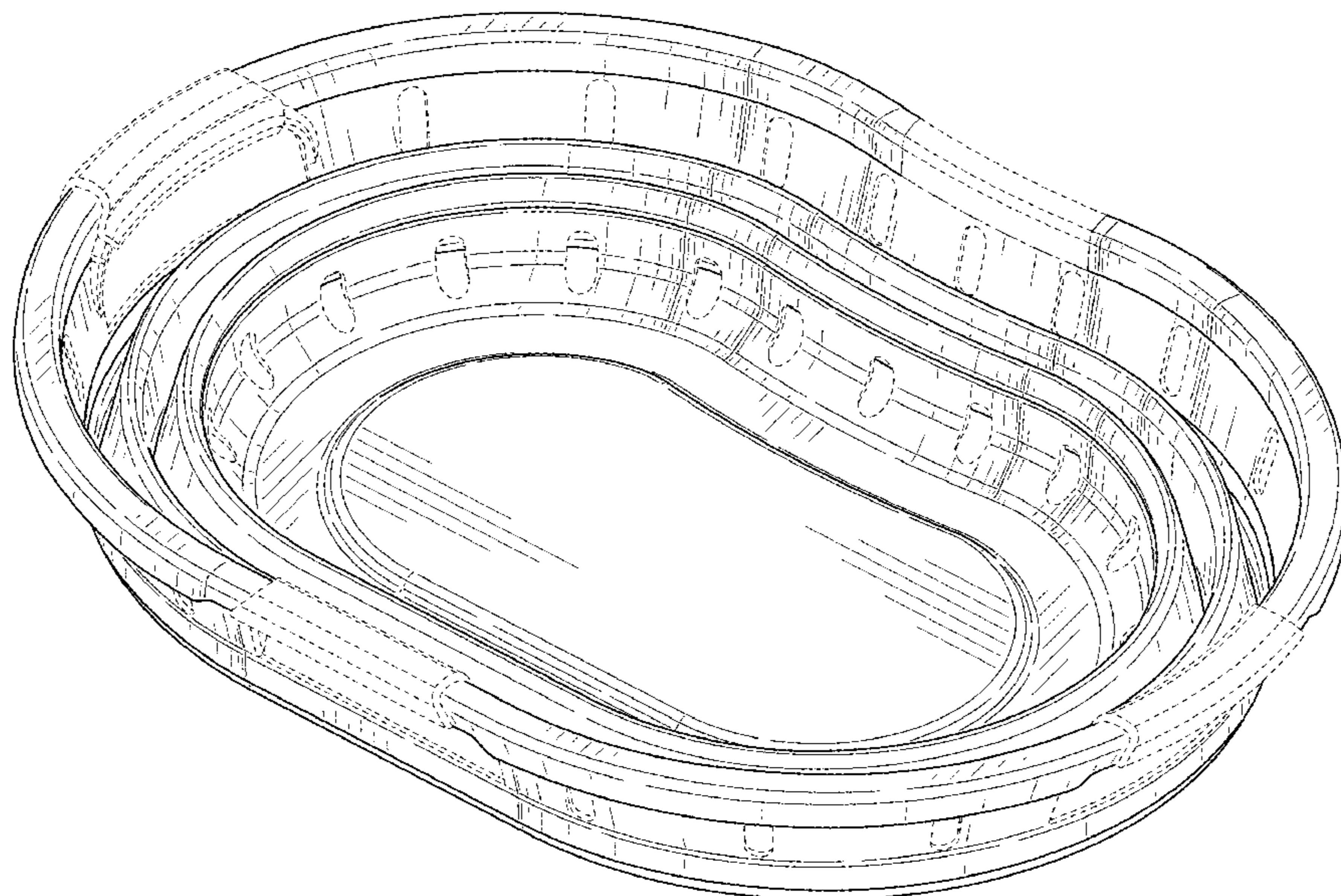

(56)

**References Cited**

U.S. PATENT DOCUMENTS

D728,939	S *	5/2015	Suomela	.....	D3/304
D775,830	S *	1/2017	Duvigneau	.....	D3/304
D804,181	S *	12/2017	Takagaki	.....	D3/307
9,926,105	B2	3/2018	Tsui		
D831,920	S *	10/2018	Duvigneau	.....	D32/37
10,201,218	B2 *	2/2019	Perlik	.....	A45C 5/045
D865,364	S *	11/2019	Brunner	.....	D3/304
D874,770	S *	2/2020	Sanchez-Vizcaino	.....	D32/37
D878,051	S *	3/2020	Kraemer	.....	D3/307
2001/0027977	A1 *	10/2001	Hall	.....	D06F 95/002 220/523
2005/0011900	A1 *	1/2005	DeRosa	.....	D06F 95/002 220/676
2005/0189360	A1 *	9/2005	Loucks	.....	D06F 95/002 220/676

OTHER PUBLICATIONS

U.S. Appl. No. 15/789,599, filed Oct. 20, 2017 titled Collapsible Shape-Retaining Containers; Inventor Sam Tung Tsui.

\* cited by examiner

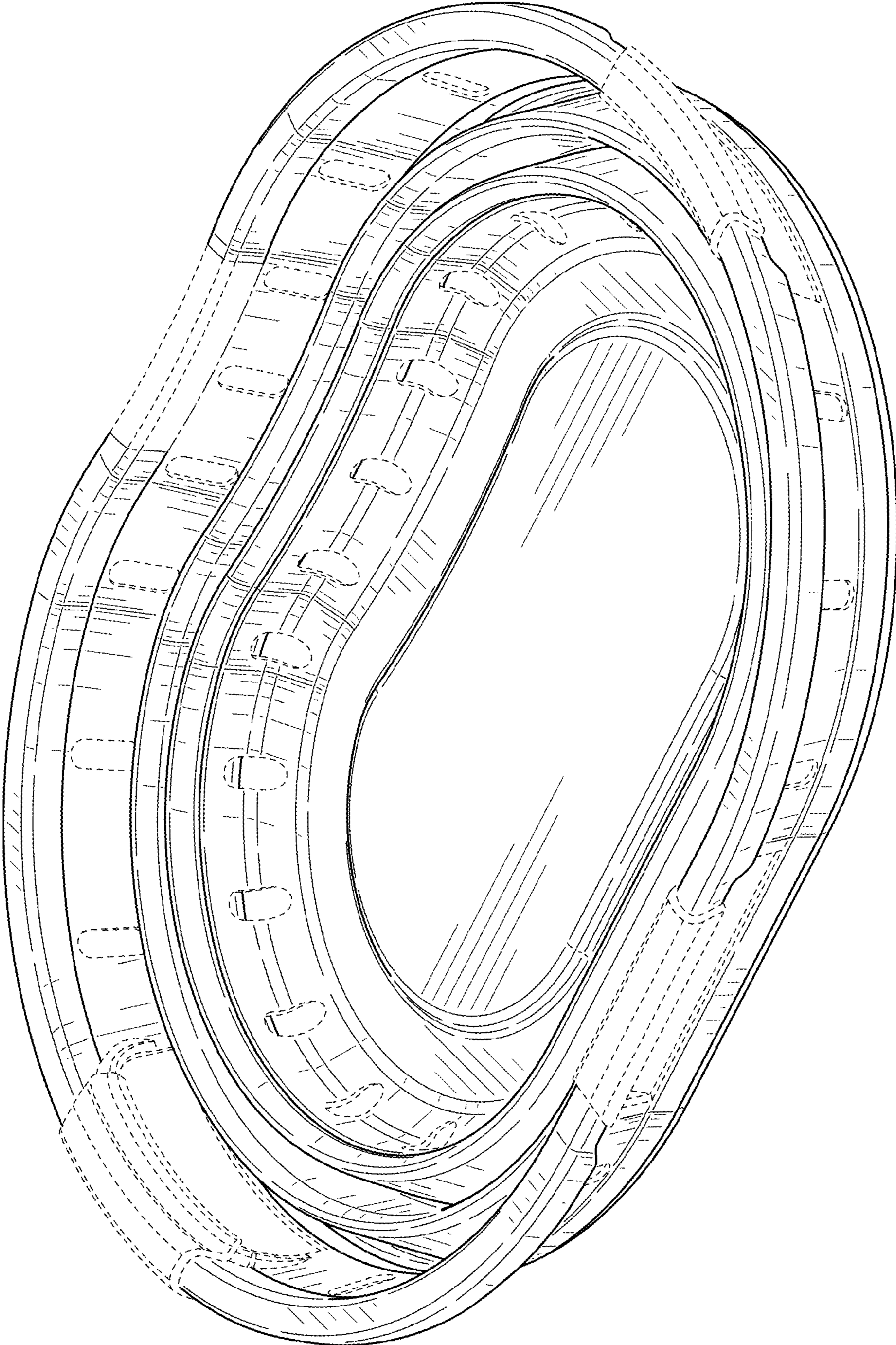

FIG. 1

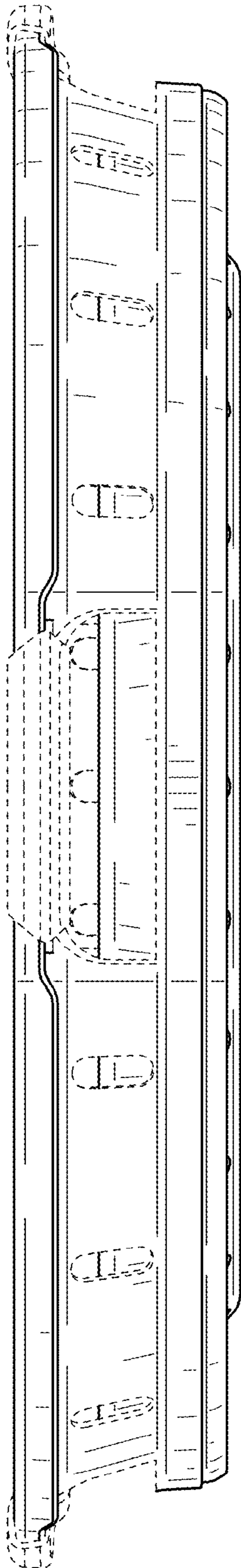

FIG. 2

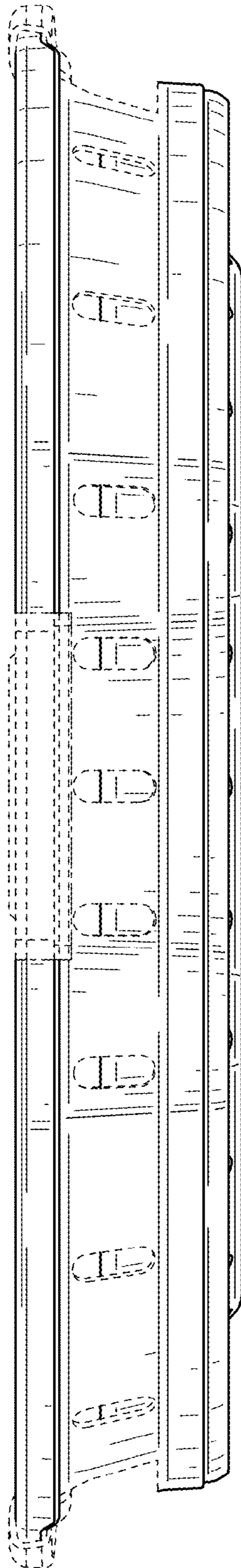

FIG. 3

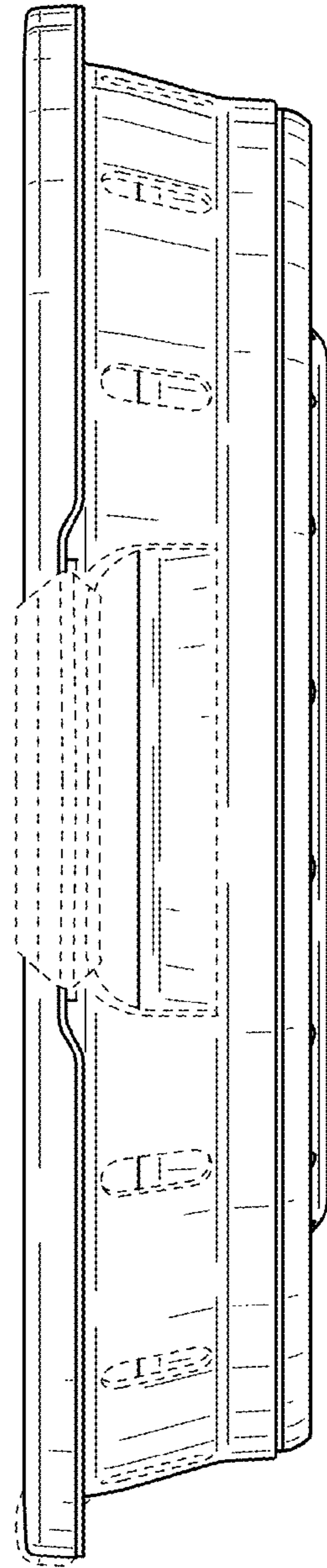

FIG. 4

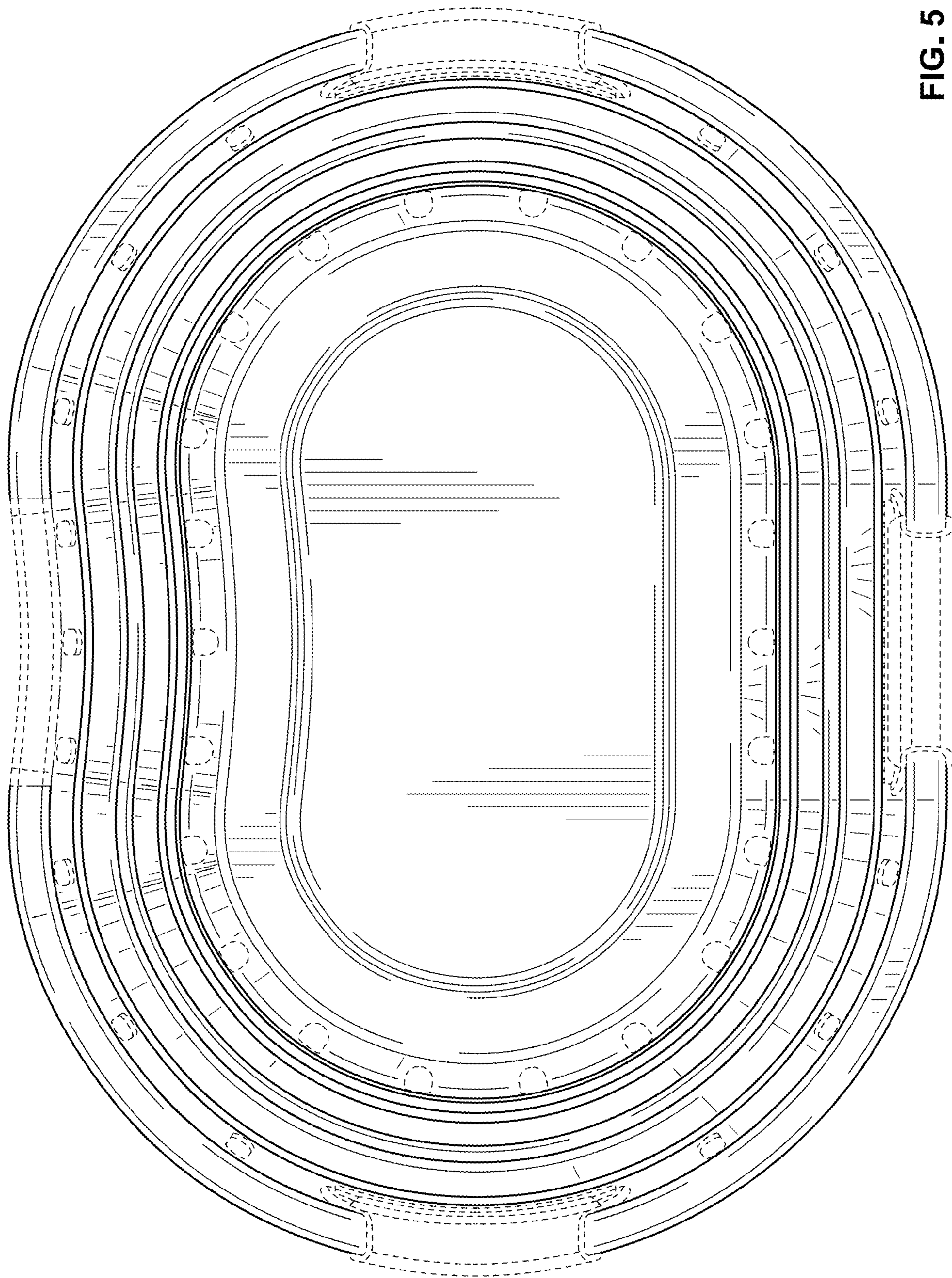

FIG. 5

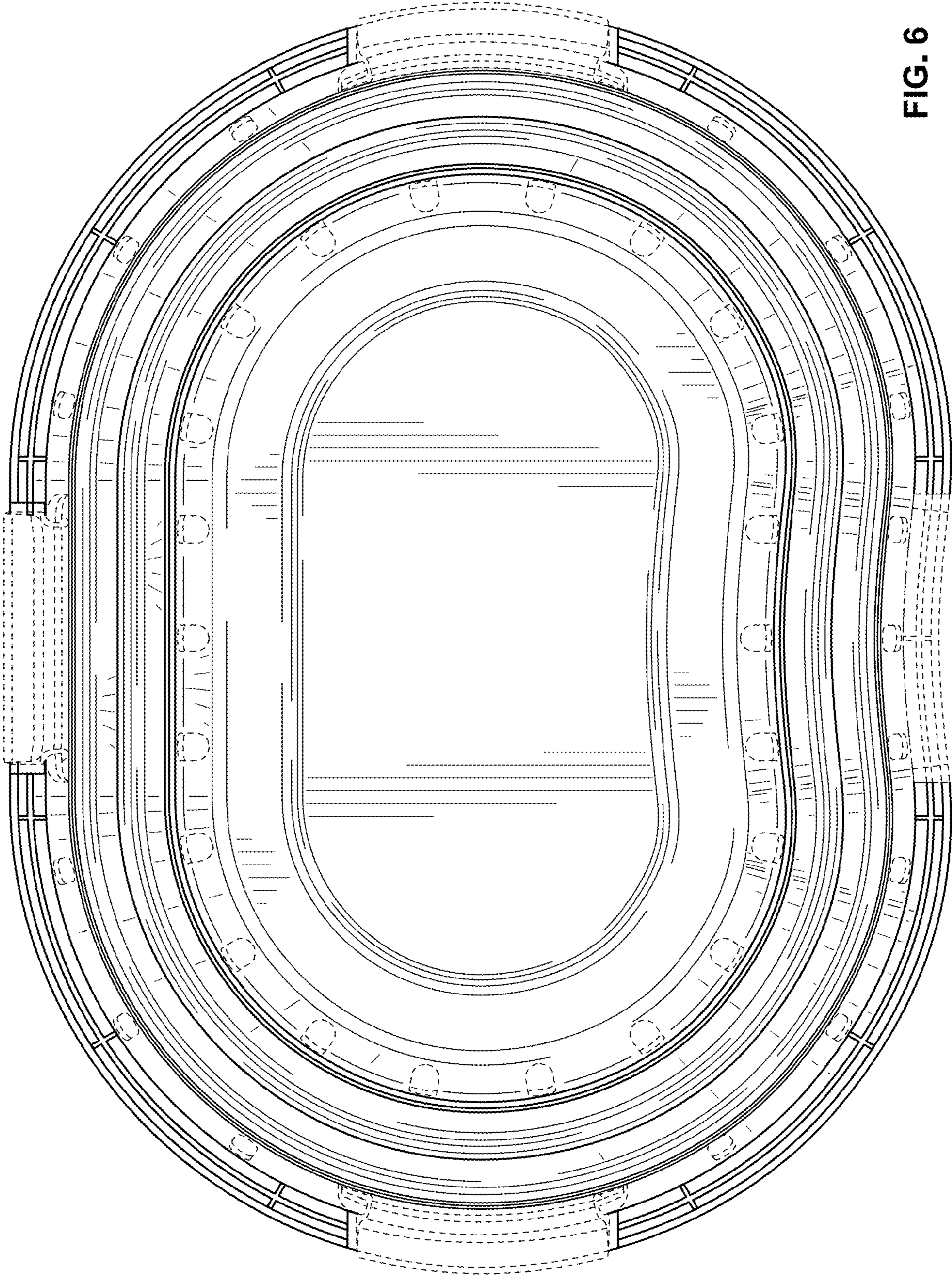

FIG. 6